



## Husqvarna H Class E20 Sewing Machine

**View & Buy Here:**

<https://www.thesewingstudio.co.uk/husqvarna-e20-sewing-machine.ir>

## ZIG ZAG SEWING

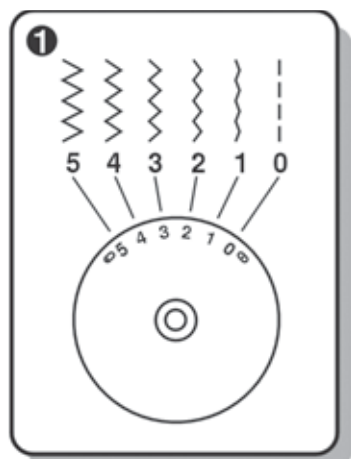

Turn the pattern selector dial to “B”.

### Function of stitch width dial

The maximum zigzag stitch width for zigzag stitching is “5”; however, the width can be reduced on any pattern. The width increases as you move zigzag dial from “0” - “5”. For twin needle sewing, never set the width wider than “2.5”. (1)

### Function of stitch length dial while zigzagging

The density of zigzag stitches increase as the setting of stitch length dial approaches “0”. Most zigzag stitches are sewn at “2.5” or below. (2)

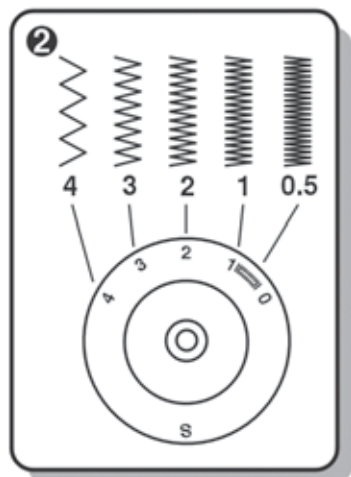

### Satin stitch

When the stitch length is set between “0” - “1”, the stitches are very close together producing the “satin stitch” which is used for making buttonholes and decorative stitches.

### Sewing thin fabrics

When sewing very thin fabrics, it is suggested that you use stabilizer on the wrong side of the fabric.

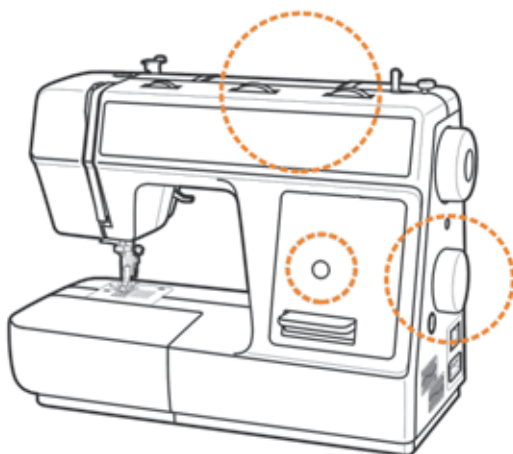
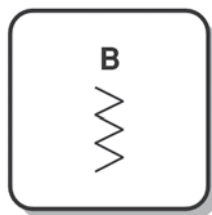

## STRAIGHT STITCHING AND NEEDLE POSITION

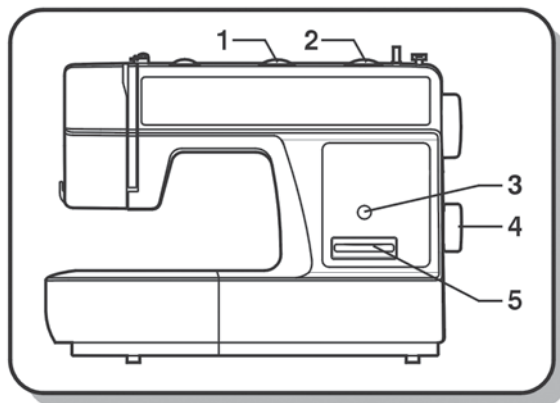

1. Stitch width dial
2. Stitch length dial
3. Stitch display
4. Pattern selector dial
5. Reverse sewing lever

Turn the pattern selector dial so that the stitch display shows the straight stitch position (A).

Generally speaking, the thicker the fabric, thread and needle, the longer the stitch should be.

Choose your needle position, from center position to left needle position by changing the stitch width dial (1) from "0" to "5".



## OVERLOCK STITCHES



### Seams, overcasting, visible hems.

Turn the stitch length dial to “3” or “S”.

The stitch width can be adjusted to suit the fabric.

### Double overlock stitch:

Set stitch length to S.

For fine knits, handknits, seams. (1)

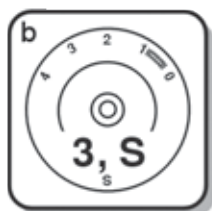

### Standard overlock:

Set stitch length to S.

For fine knits, jerseys, neck edges, ribbing. (2)

### Stretch overlock:

Set stitch length to S.

For fine knits, jerseys, neck edges, ribbing. (3)

All overlock stitches are suitable for sewing and finishing/overcasting edges in one step.

When overcasting, the needle should just go over the edge of the fabric.



**Attention:** Use new needles or ball point needles or stretch needles!

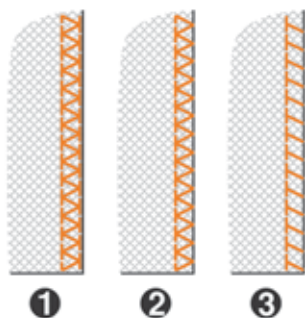

## BLIND HEM



For hems in curtains, trousers, skirts, etc.

..... Blind hem for woven fabrics. Position “C” on selection dial.

..... Blind hem for stretch fabrics. Position “D” on selection dial.

Set the machine as illustrated.



**Note:** It takes practice to sew blind hems. Always make a test on scraps.

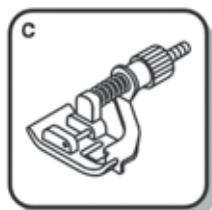

Fold the fabric as illustrated with the wrong side up. (1)

Place the fabric under the foot. Turn the handwheel towards you by hand until the needle swings fully to the left. It should just pierce the fold of the fabric. If it does not, adjust the stitch width accordingly. (2) Adjust the guide (3) by turning the knob (4) so that the guide just rests against the fold. Sew slowly, by pressing the foot control lightly. Guide the fabric along the edge of the guide.

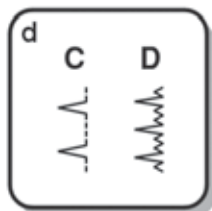

- a. Stitch width
- b. Stitch length
- c. Presser foot
- d. Stitch pattern

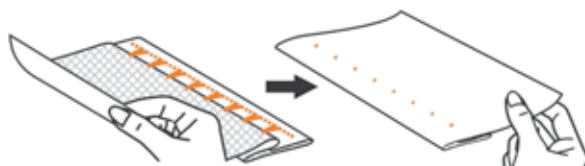
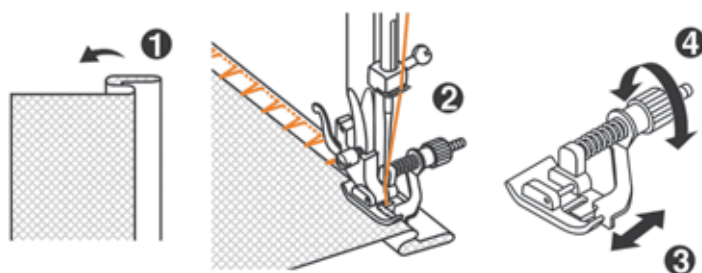

# ONE STEP BUTTONHOLES

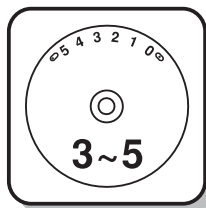

Buttonhole sewing is a simple process that provides reliable results. Always sew a practice buttonhole on a sample of your fabric and interfacing.

## Making a Buttonhole

1. Using tailor's chalk, mark the position of the buttonhole on the fabric.
2. Attach the buttonhole foot and set the pattern selector dial to . Set stitch length dial to . Adjust stitch width to desired width: 3 for narrow buttonhole and 5 for wide buttonhole.
3. Lower the presser foot aligning the marks on foot with the marks on the fabric (A). (The front bar tack will be sewn first.)
4. Open the button plate and insert the button (B).
5. Lower the buttonhole lever and gently push it back (C).
6. While lightly holding the upper thread, start sewing.
7. Buttonhole stitching is done in the order shown in the diagram (D).
8. Stop the machine when the buttonhole is sewn.

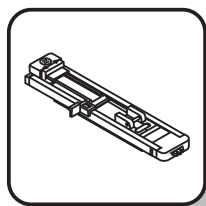
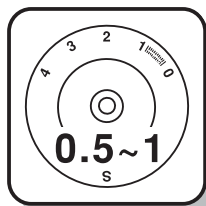

## Making a Buttonhole on Stretch Fabrics (E)

When sewing buttonholes on stretch fabric, hook heavy thread or cord under the buttonhole foot. When the buttonhole is sewn the satin columns will sew over the cord.

1. Mark the position of the buttonhole on the fabric with the tailor's chalk, attach the buttonhole foot, and set the pattern selector dial to . Set stitch length dial to .

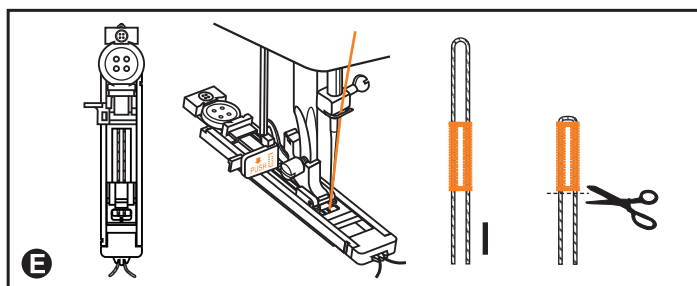
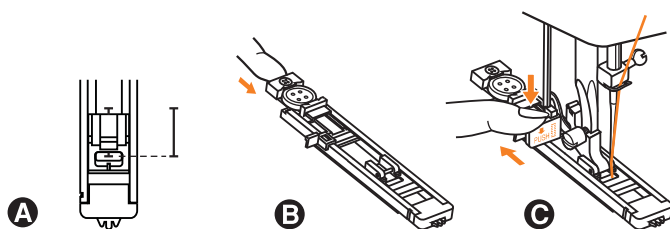

2. Hook the heavy thread onto the back of the buttonhole foot, then bring the two heavy thread ends to the front of the foot, insert them into the grooves and temporarily tie them there.
3. Lower the presser foot and start sewing.  
\* Set the stitch width to match the diameter of the gimp thread.
4. Once sewing is completed, gently pull the heavy thread to remove any slack, then trim off the excess.

## LEFT AND RIGHT SIDE BALANCE FOR BUTTONHOLE

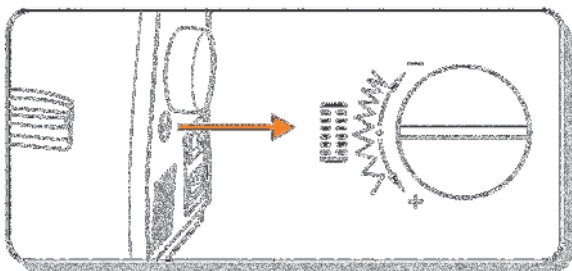

Stitch density on right and left sides of buttonhole can be adjusted with the buttonhole balance control dial near the handwheel.

This dial should usually be in a neutral position (between + and -).

If the stitches on the left side of the buttonhole are too close together, turn the dial to the left (+). Turning dial to the left makes zigzag stitches in the left column further apart.

If the stitches on the left side of the buttonhole are too open, turn the dial to the right (-). Turning dial to the right brings the zigzag stitches on the left side closer together (more dense).

The stitch on the right side of the buttonhole is set using the stitch length dial.

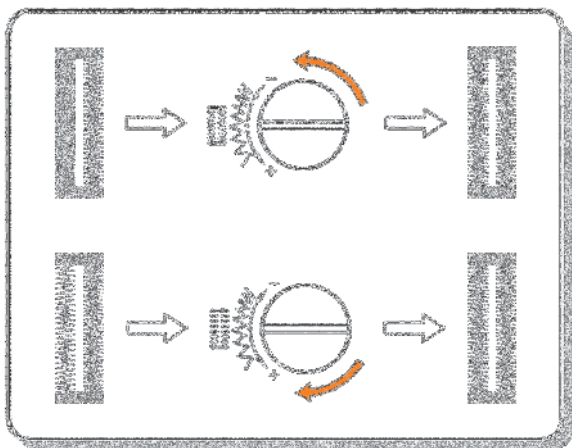

## ZIPPERS AND PIPING

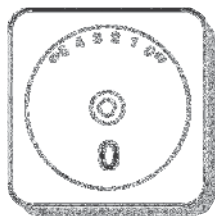

Set the machine as illustrated. Pattern selector on "A".  
Set stitch length control between "1" - "4" (according to thickness of fabric).



The zipper foot can be snapped onto the right or left of the shank/ankle, depending on which side of the zipper you are going to sew. (1)

To sew past the zipper pull, lower the needle into the fabric, raise the presser foot and push the zipper pull behind the presser foot. Lower the foot and continue to sew.



It is also possible to sew in a length of cord, into a bias strip to make piping (2).

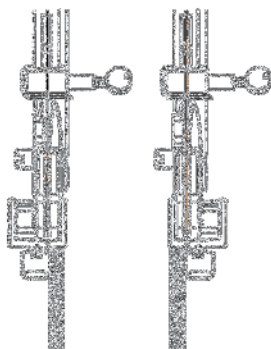

1

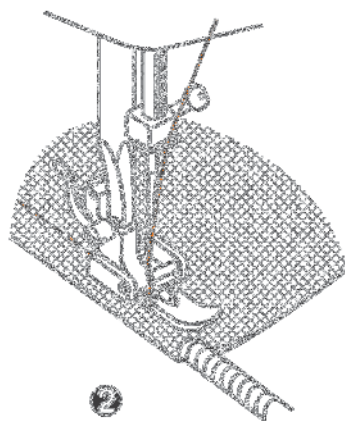

2



## 3-STEP ZIG-ZAG



Sewing on lace and elastic, darning, mending, reinforcing edges.

Set the machine as illustrated. Pattern selector on "E".

Stitch width 3-5

Place patch in position. The stitch length can be shortened to produce very close stitches. (1)



When mending tears, it is advisable to use a piece of backing fabric to reinforce. The stitch density can be varied by adjusting the stitch length. First sew over the center and then overlap on both sides. Depending on the type of fabric and damage, sew between 3 and 5 rows. (2)



### Sewing elastic

1. Place the elastic on the fabric.
2. As you sew, stretch the elastic both in the front and behind the presser foot as shown in fig. (3)



### Joining fabric

The elastic stitch can be used to join two pieces of fabric together and is very effective when sewing knitted fabrics. If nylon thread is used, the stitch will not be visible.

1. Place the edges of the two pieces of fabric together and center them under the presser foot.
2. Sew them together using the 3-step zigzag stitch taking care to keep the two fabric edges close together as shown in fig. (4)

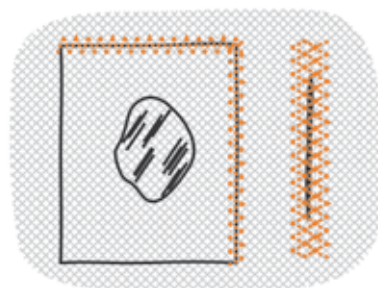

1

2

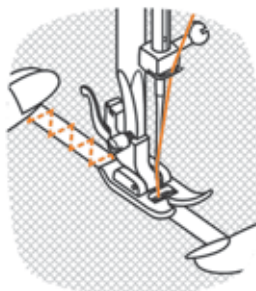

3

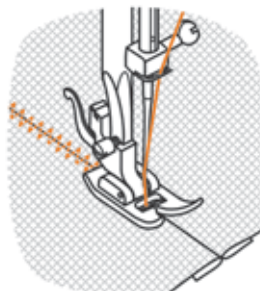

4

## STRETCH STITCH SELECTION

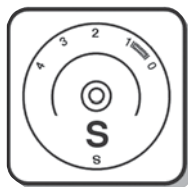

### Triple straight stitch: (1/3)

Pattern selector on "A".

For reinforced seams.

Turn the stitch length dial to "S".

The machine sews two stitches forwards and one stitch backwards.

This gives triple reinforcement.

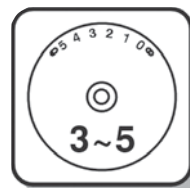
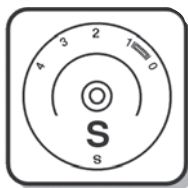

### Triple zig-zag: (2/4)

Pattern selector on "B".

For reinforced seams, hems and decorative seams.

Turn the stitch length dial to "S".

Adjust the stitch width dial to between "3" and "5".

Triple zig-zag is suitable for firm fabrics like denim, corduroy, etc.



①



②



③

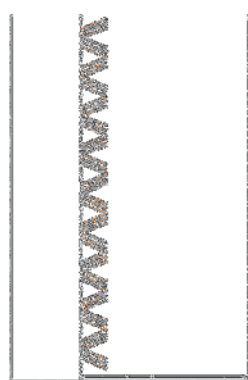

④

# FREE MOTION DARNING



Set the machine as illustrated.

Move the feed dog adjustment lever to right side to lower the feed dogs. (1)

Remove the presser foot shank. (2)

Attach the darning foot to the presser foot bar. The lever (A) should be behind the needle clamp screw (B). Press the darning foot on firmly from behind with your index finger and tighten the screw (C). (3)



First sew around the edge of the hole (to secure the threads).

(4) First row: Always work from left to right. Turn work by 1/4 and oversew.

A darning hoop is recommended for easier sewing and better results.

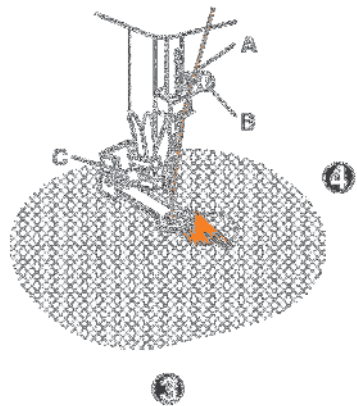
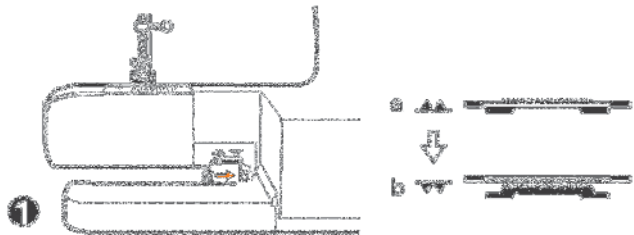

## DARNING

---

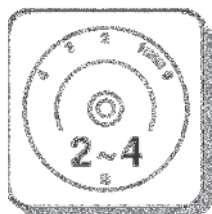
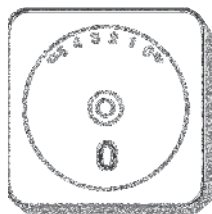

- Turn stitch length dial to the desired length.
- Turn stitch selector to straight stitch, center needle position.
- Position the fabric to be darned under the presser foot with the underlay fabric.
- Lower the presser foot and alternately sew forward and reverse using the reverse lever.
- Repeat this motion until the area to be darned is filled with rows of stitching.

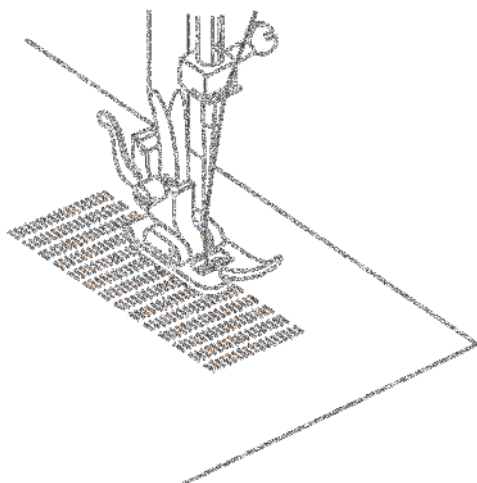

## QUILTING

---



Set pattern selector as illustrated.

Insert the quilting guide in presser foot shank and set the space as you desired.



Move the fabric over and sew successive rows with the guide riding along on the previous row of stitching.

