



View this machine and more at:

<https://www.thesewingstudio.co.uk>



BERNINA L 890

User manual

Table of Contents

1	IMPORTANT SAFETY INSTRUCTIONS	7	3.5	Needle area	44
	Important information	9		Needle holder	44
2	My BERNINA overlocker	11		Changing the Needle	45
2.1	Introduction	11		Threading the needle manually	47
2.2	BERNINA quality control	11		Positioning the needles up/down	48
2.3	Welcome to the world of BERNINA	11		Adjusting the needle stop up/down	48
2.4	Machine overview	13	3.6	Machine covers	49
	Overview - front	13		Open/close the threader cover	49
	Overview - needle area	14		Open/close the looper cover	50
	Overview - looper area	16		Removing/attaching the knife cover insert	50
	Overview - threading area	17		Removing/attaching the coverstitch insert	51
	Overview - side	18	3.7	Handwheel	52
	Overview - rear	19	3.8	Sewing Assistance	52
	Symbols on the machine	20		Using the thread cutter	52
	Default values	22		Attaching/removing the knee lifter	52
2.5	Overview - standard accessories	22		Attaching/removing the cut-offs bin	53
	Included accessories	22		Attaching/removing the freearm cover	54
2.6	Details of the screen	27		Attaching/removing the slide-on table	54
	Software operation	27		Attaching/removing the seam guide	55
	Screen structure	30	4	Setting up software	56
	Home screen	31	4.1	Setup Program	56
	Sewing screen	33		Adjusting the sewing speed	56
3	Setting up the machine	37		Adjusting screen brightness/sewing light	57
3.1	Connecting the machine and switching it on	37		Activating the audio signals	57
	Connecting the machine	37		Setting up the firmware	58
	Switching the machine on/off	37		Personalize the sewing screen	58
3.2	Thread stand	38		Presser foot indicator	59
	Preparing the retractable thread guide	38	4.2	Querying the Tutorial	59
	Attaching the spool stabilizer	39	4.3	Activating the eco mode	60
	Place the spool disc	39	5	Sewing start	61
	Using the spool net	40	5.1	Check before starting to sew	61
3.3	Foot control	40	5.2	Selecting the fabric	61
	Connect the foot control	40	5.3	Selecting the thread	61
	Press the foot control	41		Selecting the needle thread	62
3.4	Presser foot	42		Selecting the looper thread	62
	Positioning the presser foot up/down	42	5.4	Selecting the needle	63
	Lifting the front foot	42		Needle overview	64
	Lifting the presser foot up/down with the knee lifter	43		Detect defective needles	65
	Swing the presser foot in/out	43	5.5	Fixing fabric layers	65
	Changing the presser foot	44			



6	Stitch	66	Threading the overlock needle thread RN/green	96
6.1	Stitch type	66	Threading the coverstitch needle thread left LC/yellow .	97
	Overlockstitch	66	Threading the coverstitch needle thread center CC/ green	98
	Coverstitch	69	Threading the right coverstitch needle thread RC/blue ..	99
	Chainstitch	69		
	Combostitch	70		
6.2	Stitch selection on the screen	71	8.4 Changing the thread	100
	Selecting a stitch directly	71	Knotting thick thread	100
	Selecting a stitch from the personal memory	72	Changing the needle thread	101
	Using the stitch recommendation of creative consultant	73	Changing the looper thread	102
7	Machine settings	74	9 Sewing test	103
7.1	Preparing the machine for overlock or overlock/ chainstitch combo	74	9.1 Performing a sewing test for an overlock stitch	103
7.2	Preparing the machine for cover- and chainstitch ...	74	9.2 Performing a sewing test for an coverstitch	103
7.3	Setting the knife	74	9.3 Performing a sewing test for an chainstitch	103
	Knife on/off	74	9.4 Stitch optimizer	104
	Setting the cutting width	75		
7.4	Setting the upper looper on/off	76	10 Practical overlocking	105
7.5	Upper looper converter hooked in/hooked out	77	10.1 Securing overlock stitches	105
7.6	Adjusting the thread tension	78	Sewing in the overlock chain at the start of the seam ...	105
7.7	Adjusting the differential feed	80	Sewing in the overlock chain at the end of the seam	105
7.8	Setting the rolled hem selection lever «O/R»	83	Securing overlock stitches	106
	Overlocking «O»	83	Knotting the overlock chain	106
	Rolled hem «R»	83	10.2 Undoing overlock stitches	106
7.9	Setting the mtc micro thread control	84	10.3 Securing cover- and chainstitches	107
7.10	Setting the presser foot pressure	85	Securing cover- and chainstitches at the start of the seam	107
7.11	Adjusting the stitch width	86	Securing coverstitches at the seam end	107
	Changing the stitch width via the needle position	86	10.4 Undoing coverstitches	108
	Changing the stitch width via the cutting width	86	10.5 Undoing chainstitches	108
7.12	Adjusting the stitch length	86	10.6 Sew blanket stitch	109
8	Threading	87	10.7 Gathering	110
8.1	Preparing for threading	88	Increasing the differential feed	110
8.2	One-step BERNINA air threader	89	Pulling the needle thread	110
	Performing a pulse drive	89	10.8 Sew outer corners	111
	Threading the looper threads UL/blue, LL/red, CL/ purple	90	10.9 Sew inner corners	112
	Threading the looper thread with an auxiliary thread ..	91	10.10 Sewing inner curves	113
	Circumventing the air threader	92	10.11 Sew outer curves and circles	113
	Using the threading wire	94	10.12 Sewing a hem	114
8.3	Threading the needle thread	95	10.13 Flat joining seams	115
	Threading the overlock needle thread LN/yellow	95		
			11 Care and maintenance	116
			11.1 Firmware	116
			Selecting a language	116
			Information on the firmware	117



Restore factory settings	118
Updating firmware	119
Calibrate screen	120
11.2 Machine	121
Cleaning the machine	121
Cleaning the looper area	121
Cleaning the air threader pipes	122
Cleaning the screen	123
Cleaning the suction feet	123
Oiling the machine	123
12 Errors and faults	124
12.1 Troubleshooting	124
13 Storage and disposal	126
13.1 Storing the machine	126
13.2 Transporting the machine	126
13.3 Dispose of the machine	126
14 Technical data	127
Index	128



- Do not use this machine if the cable or plug is damaged, the machine is not functioning correctly, it is dropped or becomes damaged or falls in water. Never operate this machine if it has a damaged cord or plug, if it is not working properly, if it has been dropped or damaged, or dropped into water. Contact the nearest authorized BERNINA dealer to arrange further details.
- Only use accessories recommended by the manufacturer.
- Do not use this machine if the ventilation openings are blocked. Keep all ventilation openings and foot control free of lint, dust and loose cloth.
- Do not insert any objects into the openings of the machine.
- Do not place any objects on the foot control.
- Always use the machine with a foot control of this type LV-1.
- Do not use the machine anywhere that oxygen or propellant products (sprays) are being used.
- The knife cover insert or coverstitch insert must be attached continuously while operating the machine.
- Keep fingers away from all rotating and moving parts. Special care is required in the needle area, the looper and the knife.
- Neither pull nor push the fabric while sewing. This can cause needle breakage.
- Turn power switch to «0» when making any adjustments in the needle area, such as threading the needle or changing the needle or the presser foot.
- Never use damaged needles.
- Always use the original BERNINA stitch plate. The wrong stitch plate can cause needle breakage.
- To disconnect, turn power switch to "0" and then remove the plug from the outlet. Always pull on the plug and not the cable.
- Disconnect the plug before removing or opening the covers, oiling the machine or performing any cleaning or maintenance work described in this instruction manual.
- This machine is double-insulated (except for USA, Canada and Japan). Use only genuine replacement parts. See instructions for Servicing of double-insulated products.



Explanation of symbols



Designates a high-risk hazard which can lead to serious injuries or potentially even death if not avoided.



Designates a medium-risk hazard which can lead to serious injuries if not avoided.



Designates a low-risk hazard which can lead to minor or moderate injuries if not avoided.



Designates a hazard which can lead to material damage if not avoided.



You will find **tips** from BERNINA **sewing experts** next to this symbol.

2 My BERNINA overlocker

2.1 Introduction

Since the introduction of the overlocker for household use in the early 80s, they have become a standard sewing tool and are here to stay. Overlockers not only sew faster than conventional sewing machines, they also achieve more steps in just a single operation, which saves time. Seams are cut back, seamed and finished simultaneously in one task. With the differential transport, particularly fine fabrics or very elastic materials can be processed professionally.

Stitches varieties of 18 overlock stitches, 5 coverstitches and 4 combo stitches are available for sewing comfortably with tried-and-tested Swiss quality.

In addition to this instruction manual for your BERNINA L 890 the following information products are enclosed.

The current version of your manual as well as many other information about the machine and the accessories can be found on our website www.bernina.com

2.2 BERNINA quality control

All BERNINA machines are assembled with utmost care and are subjected to an extensive functionality test. The subsequent thorough cleaning does not exclude the possibility that thread remnants may still be found in the machine.

2.3 Welcome to the world of BERNINA

Made to create, this is the slogan of BERNINA. Not only with our machines do we support you in the implementation of your ideas. In addition to the offers listed below, we offer you lots of suggestions and instructions for your future projects as well as the opportunity to exchange ideas with other sewing, quilting and embroidery enthusiasts. I wish you lots of pleasure.

BERNINA YouTube Channel

On YouTube we offer a wide range of how-to videos and support concerning the most important functions of our machines. Detailed explanations are also provided as for the various presser feet, so that your projects will succeed completely.

<http://www.youtube.com/BerninaInternational>

Provided in the languages English and German.

inspiration – the sewing magazine

Are you looking for ideas and instructions for great projects? In that case the BERNINA magazine «inspiration» is exactly what you need. «inspiration» offers extraordinary sewing and embroidery ideas four times a year. From seasonal fashion trends to trendy accessories and practical tips to decorate your home in an original way.

<http://www.bernina.com/inspiration>

The magazine is available in the languages English, German, Dutch and French. Not available in all countries.

BERNINA Blog

Fancy instructions, free sewing patterns and embroidery motifs as well as many new ideas: all this you can find in the weekly blog by BERNINA. Our experts give valuable tips and explain step by step how you can achieve the desired result. In the community you can upload your own projects and exchange experiences and ideas with other sewing and embroidering enthusiasts.

<http://www.bernina.com/blog>

Provided in the languages English, German and Dutch.

BERNINA Social Media

Follow us on the social networking to learn more about events, thrilling projects as well as tips and tricks all about sewing, quilting and embroidering. We will keep you informed and we are looking forward to presenting you the one or the other highlight from the world of BERNINA.

<http://www.bernina.com/social-media>



Overview - needle area

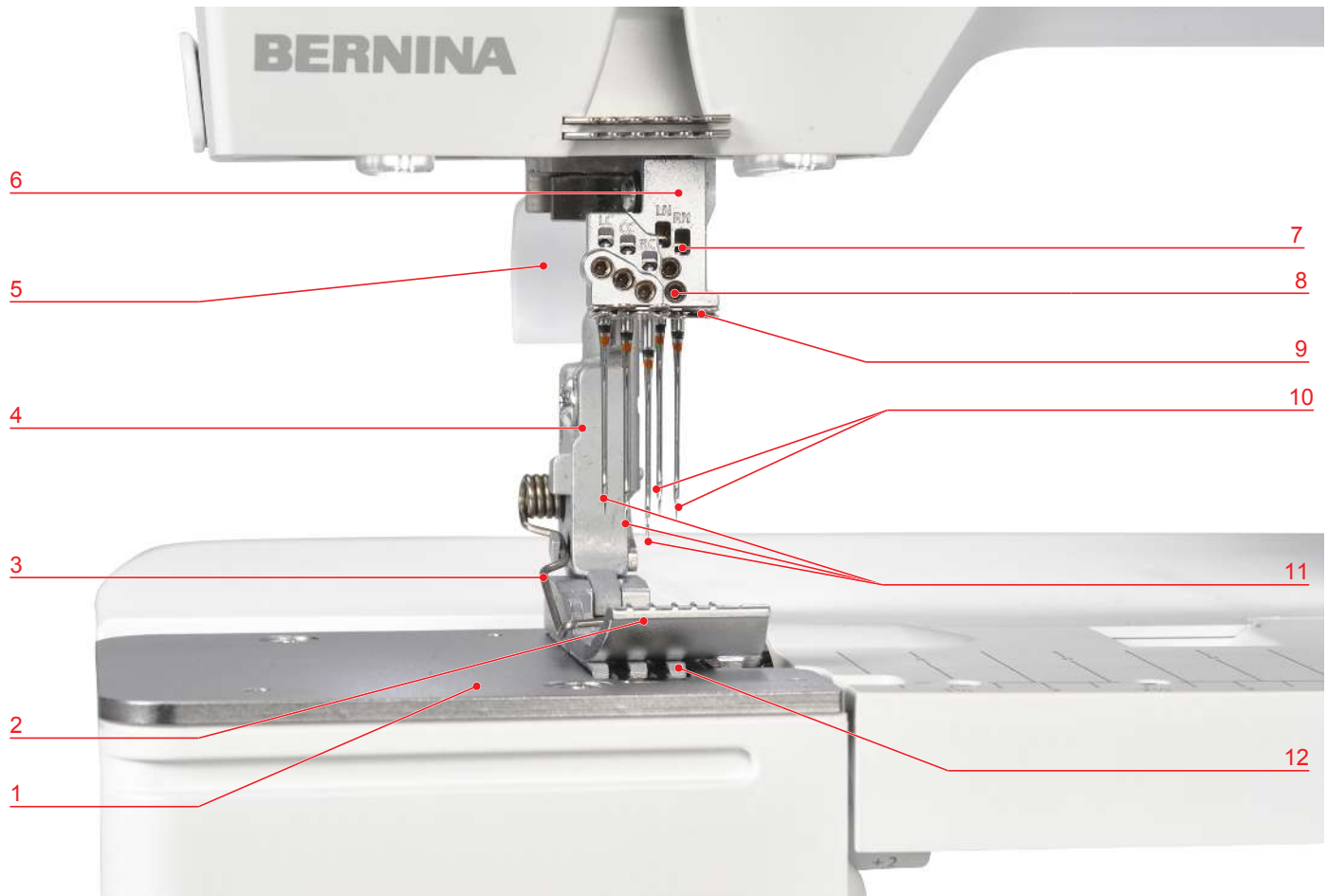

- | | | | |
|---|--|----|-------------------------------------|
| 1 | Stitch plate | 7 | Needle checking window |
| 2 | Standard presser foot overlock/coverstitch | 8 | Needle screws |
| 3 | Presser foot spring | 9 | Thread guide on the needle holder |
| 4 | Presser foot shaft | 10 | Overlock needles ELx705 CF (2 pcs.) |
| 5 | Presser foot lifter | 11 | CS needles ELx705 (3 pcs.) |
| 6 | Needle holder | 12 | Feed dog |



Standard presser foot overlock/coverstitch



A Cutting line at cutting width 6

B Right needle for OL (RN)

C Left needle for OL (LN)

D Right needle for CS (RC)

E Center needle for CS (CC)

F Left needle for CS (LC)



Overview - looper area

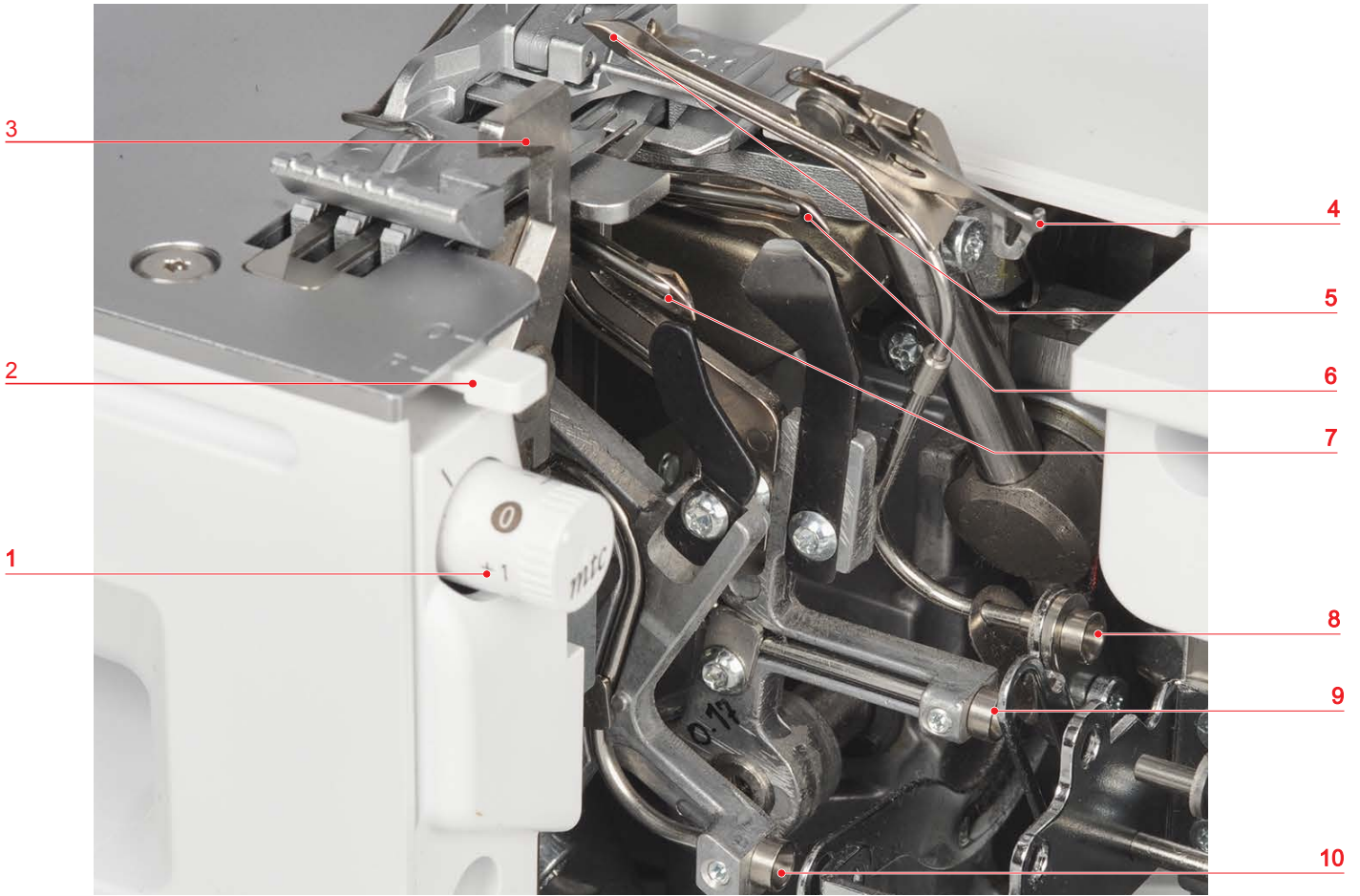

- | | | | |
|---|-------------------------------|----|---------------------------------|
| 1 | mtc micro thread control dial | 6 | Lower looper |
| 2 | Rolled hem selection lever | 7 | Chain looper |
| 3 | Knife | 8 | Air threader pipes upper looper |
| 4 | Upper looper converter | 9 | Air threader pipes lower looper |
| 5 | Upper looper | 10 | Air threader pipes chain looper |

Overview - side



- | | | | |
|---|---------------------------------|---|-------------------------|
| 1 | Carry groove | 6 | Foot control connection |
| 2 | Handwheel | 7 | Power switch |
| 3 | Touchscreen pen magnetic holder | 8 | Type label |
| 4 | Air vents | 9 | Power cable connection |
| 5 | USB connection (covered) | | |

Overview - rear













- | | | | |
|---|-----------------------------|---|----------------------------------|
| 1 | Thread stand | 6 | Thread cutter |
| 2 | Spool pin | 7 | Presser foot lifter |
| 3 | Carrying handle | 8 | Presser foot release Lever (red) |
| 4 | Retractable thread guide | 9 | Guide rails |
| 5 | Presser foot pressure wheel | | |

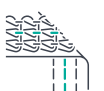

Symbols on the machine

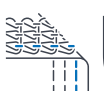
The symbols on the machine are for your guidance and give assistance when adjusting settings and threading the machine.

- Overlockstitch formation «OL»
- Coverstitch formation «CS»

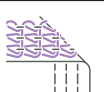
	LN (Left needle for OL)	left overlock needle thread
	LC (Left needle for CS)	left coverstitch needle thread
		Thread path yellow «OL» Thread path yellow «CS»
	RN (Right needle for OL)	right overlock needle thread
	CC (Center needle for CS)	center coverstitch needle thread
		Thread path green «OL» Thread path green «CS»
	UL (Upper looper)	Upper looper thread
	RC (Right cover needle for CS)	center coverstitch needle thread
		Thread path blue «OL» Thread path blue «CS» Thread path blue air threading circumvention
	LL (Lower looper)	Lower looper thread
		Thread path red «LL» Thread path red air threading circumvention
	CL (Chain looper)	Chain looper

Default values

The default values of the machine are chosen so that the settings are suitable for most typical applications.

- 4 ● The default values are marked on the machine with a gray dot.





The actual values may differ from the stitch chart depending on the fabric, thread and stitch and may need to be adjusted to the result of the sewing sample.

2.5 Overview - standard accessories







Included accessories

The machine is ready for operation with the supplied accessories. Special sewing applications sometimes require optional accessories.



Visit www.bernina.com for more accessories information.

Illustration	Name	Purpose
	Dust cover	To protect the machine against dust when it is not in use and to store the accessories such as the slide-on table, the instruction manual, the Free Hand System, the foot control and the power cable.
	Power cable	To connect the machine with the power supply system.
	Foot control	To start and stop the machine. To control the sewing speed. To start the air threading.
	Cut-offs Bin	To collect resulting scraps.
	Knife cover insert	To protect the fingers and to deflect the fabric cut-offs during the sewing process.

Accessories box standard with accessories

Illustration	Name	Purpose
	Overlocker oil	For oiling the looper components.
	Spool stabilizer (5x)	To stabilize the thread cone on the thread stand.
	Spool net (5x)	For even thread unwinding with smooth threads from the thread spool, e.g. nylon, rayon, silk threads or metallic yarns.
	Spool disc (5x)	To support the regular unwinding of the thread from the spool.
	Screwdriver, Torx T10	To loosen/tighten the stitch plate screws.
	Threading wire	To thread the looper threads manually in the air threader pipe.
	Needle set ELx705 CF SUK	Needles recommended for special use in knitwear.

Accessories box extension with accessories

Illustration	Name	Purpose
	<p>Touchscreen pen</p>	<p>For precise operation of the touch screen.</p>
	<p>Coverstitch lock tool</p>	<p>To pull the needle threads and to secure the stitches.</p>
	<p>Cover-/Chainstitch foot #C13</p>	<p>For cover and chainstitch seams, for general sewing work and for topstitching.</p>
	<p>Right seam guide</p>	<p>For an even fabric trim.</p> <p>To sew along a folded edge, without trimming, e.g. for flat joining seams.</p> <p>To guide while creating decorative pintucks or parallel seams and hems.</p>



2.6 Details of the screen







Software operation

The touch-sensitive screen can be operated with the finger or stylus.





Tap: Short tap of an element.

Draw: Tap the screen and slowly move in one direction, eg. for scrolling up and down.





Navigation

Illustration	Name	Purpose
	«Home»	Switch between «Home screen» and «Sewing screen».
	Navigation path	Show a previous menu level.
	Animation	Show animations on the corresponding topic.
	«Close»	Close the window.
	More	Show more features or information.
	Continue	Scroll to next display.
	Back	Scroll to previous display.

Activate/deactivate functions

Figure	Element	Status
	Switch	Function is activated.
		Function is deactivated.
	Icon	Function ist deactivated.
		Function ist activated.

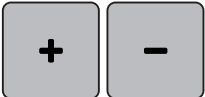





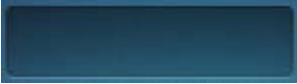

Adjust values

Illustration	Name	Purpose
	Slider control	Set the value with the slider control. Reset the value to the default value by tapping the small bullet.
	blue ribbon	The set value is in the experimental range. This can affect stitch quality.
	Field «Plus» / «Minus»	«Plus» increase, «Minus» reduce the value.
	Yellow frame	Indication that the set value differ from the default value. Reset the value to the default value by tapping.

Enter text and numbers

To enter numerical values or text, a corresponding keyboard is shown.



Illustration	Name	Purpose
	Entry field	Display of the entry. Delete all characters entered with a single tap.
	«Deleting»	Delete the last character.
	«Lower case characters»	Show the available letters in lower case letters.
	«Upper case characters»	Show the available letters in upper case letters.
	«Numbers and mathematical characters»	Show the available numbers and mathematical characters.
	«Special characters»	Show the available special characters.
	«Confirm»	Confirm the entry and leave the submenu.
	«Cancel»	Cancel the entry and the view closes.

Screen structure

The screen can be operated by touching the desired icon with your finger or with the included touchscreen pen. When the machine is switched on for the first time, the desired screen language is requested in which the screen texts appear. Each time the machine is switched on again, the sewing screen appears directly.

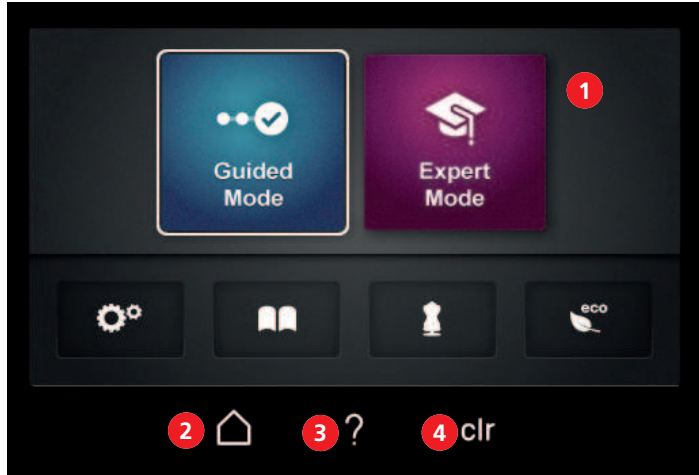

- | | |
|------------------------------------|------------|
| 1 «Home screen» or «Sewing screen» | 3 «?»-Help |
| 2 «Home» | 4 «clr» |



«Home» can switch between the two screens «Home screen» and «Sewing screen». «Home» allows you to obtain information, make machine settings or get sewing tips without losing the set stitch.



Creative consultant



The creative consultant recommends the optimal stitch in combination with needle, thread and presser foot based on an individual project. (see page 73)

eco mode



If work is interrupted for a longer period of time, the machine can be switched to power saving mode. The eco mode also serves as a child safety feature. The screen will be locked and the machine cannot be started.

User modes

The user modes allow to preset the sewing screen according to the sewing experience of the user. The Guided mode is preset.

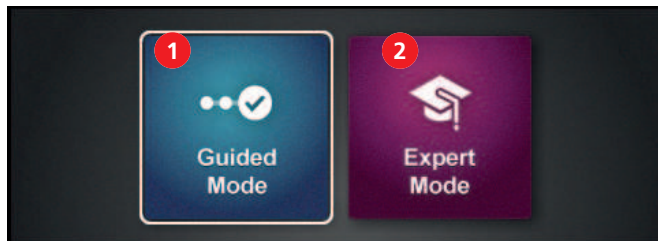

1 «Guided mode»

2 «Expert mode»

Guided mode



The guided mode is preset as standard and allows a smooth start into the operation of the machine. No previous knowledge is required. This mode guides you step by step through the necessary manual settings and leads to sewing start. Before changing to another stitch, you are asked whether the currently set stitch is to be added to the personal memory. Animations are offered in many places and help to perform the correct operation. By default, this mode is represented by a blue background of the screen.

Expert mode



The expert mode is a creative and fast mode, which allows shortened operation and only the most important instructions are indicated. In this mode a good knowledge of overlocking is required. After selecting the stitch this mode shows an overview of the manual settings, which are to be individually checked or executed. By default, this mode is represented by a purple background of the screen.



Sewing screen

This screen is for all settings that are directly related to a stitch. Different views or default values of the stitch can be displayed or the setup wizard can be called up.

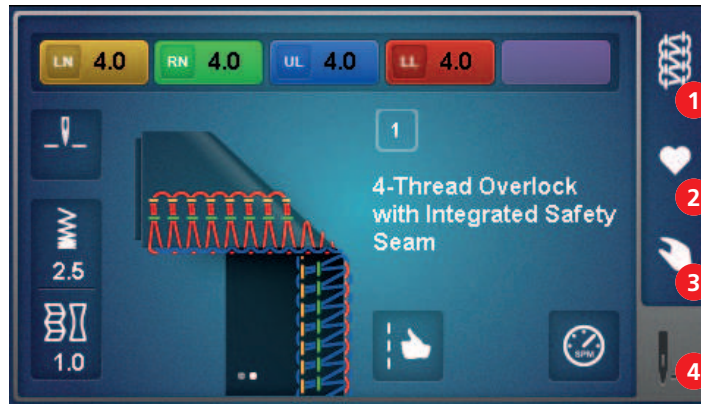

- | | | | |
|---|--------------------|---|-------------------|
| 1 | «Stitch selection» | 3 | «Manual settings» |
| 2 | «Personal memory» | 4 | «Stitch view» |

Stitch selection

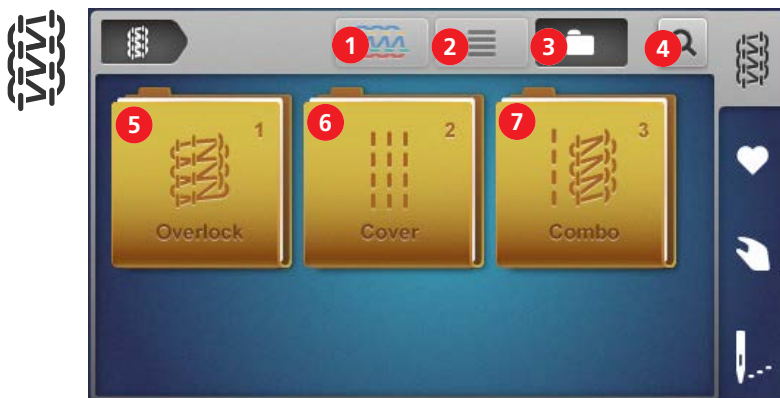

- | | | |
|---|--------------------|--|
| 1 | «Stitch pattern» | To change the stitch view from schematic to realistic view. |
| 2 | «Name» | To activate/deactivate the stitch name next to the stitch pattern. |
| 3 | «Folder structure» | To switch between stitchgroups or all stitches. |
| 4 | «Stitch number» | To select the stitch by entering the stitch number. |
| 5 | «Overlock» | To select an overlock stitch from the folder structure. |
| 6 | «Cover» | To select a coverstitch from the folder structure. |
| 7 | «Combo» | To select a combo stitch from the folder structure. |

Personal memory



In the Personal memory changed stitch settings are saved, named and selected. A stitch name is unique and can not be assigned multiple times. A maximum of 100 different stitch settings can be saved as notes.



- | | | |
|---|---------------------|---|
| 1 | «Stitch view» | To change the stitch view from schematic to realistic view. |
| 2 | «Saving a stitch» | To rename a saved stitch in the personal memory. |
| 3 | «Renaming stitch» | To rename a saved stitch in the personal memory. |
| 4 | «Deleting a stitch» | To delete the stitch from the personal memory. |



Manual settings



This overview shows which manual settings must be made for the selected stitch. All settings listed here must be checked and executed to be able to sew the selected stitch.



	Note	Description
1	«Presser foot»	Indicates the presser foot recommended for the stitch. (see page 44)
2	«Upper looper converter»	Indicates whether the upper looper converter is hooked in or hooked out. (see page 77)
3	«Knife on/off»	Indicates the necessary position of the knife. (see page 74)
4	«Cutting width»	Indicates the recommended cutting width. (see page 75)
5	«mtc micro thread control»	Indicates the recommended default value of the mtc micro thread control. (see page 84)
6	«Presser foot pressure»	Indicates the value of the presser foot pressure. (see page 85)
7	«Upper looper on/off»	Indicates the required position of the upper looper. (see page 76)
8	«Knife cover insert/coverstitch insert»	Indicates the required insert. (see page 74)
9	«Rolled hem selection lever O/R»	Indicates the position of the rolled hem selection lever. (see page 83)
10	«CS-needles»	Show the needlepositions to be used for the corresponding stitch. (see page 44) (see page 45)
11	«OL-needles»	Show the needlepositions to be used for the corresponding stitch. (see page 44) (see page 45)
12	«Cancel»	Closes the screen «manual settings» and switches to stitch view.
13	«Confirm»	Closes the screen «Manual settings» and switches to the view of actual stitch in the «Stitch view».
14	«Wizard»	Starts «step-by-step instruction» through the manual settings that must be made or controlled for the selected stitch.

Stitch view



Changes in this stitch view directly affect the stitch and the machine. All displayed values are set accordingly by the machine.

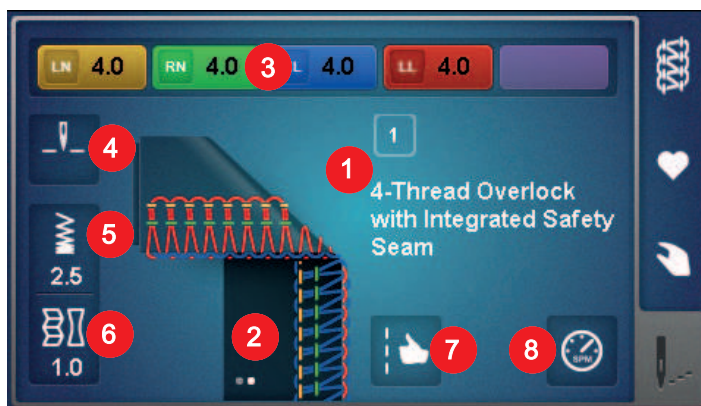

- | | | |
|---|---------------------------|---|
| 1 | «Stitch number/name» | Show the actual set stitch name with stitch number. |
| 2 | «Stitch view» | Show the currently set stitch pattern. Can contain multiple views (schematic / real or exploded eg flat seam). The points refer to the number of hidden views. Tap to switch views. |
| 3 | «Thread tension» | Show the preset default thread tension value for each required thread path. Tap to change. |
| 4 | «Needle stop up/down» | Indicates the position of the needle when the needle stops. Tap to set. |
| 5 | «Stitch length» | Indicates the stitch length. Tap to change. |
| 6 | «Differential feed» | Indicates the preset default value of the differential Feed. Tap to change. |
| 7 | «Stitch optimizer» | Show possible stitch results with the setting actions for stitch optimization. Tap to use. |
| 8 | «Sewing speed adjustment» | Determines the maximum sewing speed with the foot controller pressed down. Tap to change. |

Setting with direct influence on the stitch

- Stitch length setting. (see page 86)
- Differential feed setting. (see page 80)
- Thread tension adjustment setting. (see page 78)

These settings, or changes to them, are saved in the personal memory when the stitch is saved.

Functions with direct influence on the machine

- Needle stop up/down. (see page 48)
- Sewing speed setting. (see page 56)

These settings or their changes remain until they are changed again.



3 Setting up the machine

3.1 Connecting the machine and switching it on

A stable table with a secure stand is a good prerequisite for optimal sewing results. Ergonomics around the sewing table is an important point to protect the muscles and joints of the back, shoulder, arms and hands. The recommendation is to match the table height and body posture to each other. Avoid staying longer in the same position. The machine can also be operated standing up.

- > Place the machine on a stable table.
- > Before operating the machine again after storage, leave the machine unpacked for approx. 1 h at room temperature.
- > Sit comfortably in front of the machine.
- > Hold the arms 90 ° across the table, with your fingertips to the machine.
 - The fingertips should touch the stitch plate.

Connecting the machine

- > Insert the power cable into the power cable connection (1).



- > Insert the power cord plug into the power outlet.

Only USA/Canada

The machine has a polarized plug (one contact is wider than the other). To reduce the risk of electric shock, the plug can only be plugged into the socket in one way. If the plug does not fit into the socket, turn the plug. If it still does not fit, contact an electrician to install an appropriate outlet. Do not modify the plug in any way.

Switching the machine on/off

- > Set the main power switch to position «I».
 - The machine, the sewing light and the screen are switched on.
- > Set the main power switch to position «0».
 - The machine, the sewing light and the screen are switched off, whereby the sewing light may still glow a little.



- > Insert the cable of the foot control into the foot control connection (1).



Press the foot control

Pressing the foot control moves the needles, loopers and knife. The sewing speed can be infinitely adjusted by more or less pressure on the foot control. The maximum sewing speed (pressing the foot control all the way down) can be preset. (see page 56) With open threader cover, the BERNINA one-step air threader starts.

- > To start the sewing process, press the foot control down.
- > To stop the sewing process, release the pressure on the foot control.



- > To position the needle up/down, press the foot control down with the heel «Back-kick».



The «Back-kick» is deactivated when the machine covers are open.

- > Release the tension on the presser foot lifter.
 - The presser foot is held in the lock-in position.



Lifting the presser foot up/down with the knee lifter

Temporarily lifting the presser foot using the Free Hand System allows the sewing project to be repositioned using both hands.



Prerequisite:

- The knee lifter of the Free Hand System is attached. (see page 52)
- > To raise the presser foot, press the knee lifter with the knee out to the right and hold it in place.
 - > To lower the raised presser foot, slowly release the pressure on the knee lifter.
 - > To lower the already engaged presser foot, press the knee lifter all the way to the right and release slowly.

Swing the presser foot in/out

Swinging out the presser foot facilitates changing and threading the needle.

Prerequisite:

- The needles are in the top position. (see page 48)
 - The presser foot is raised.
- > Swing the presser foot front sideways to the left.

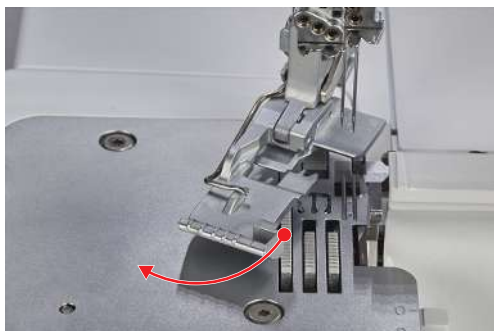

- > To set the presser foot in the sewing position, lower the presser foot lifter or swing the presser foot sideways to the right.

Changing the presser foot

Prerequisite:

- The needles are in the top position.
 - The presser foot is raised.
- > Press the release button on the rear side of the presser foot shaft.
- The presser foot is released.

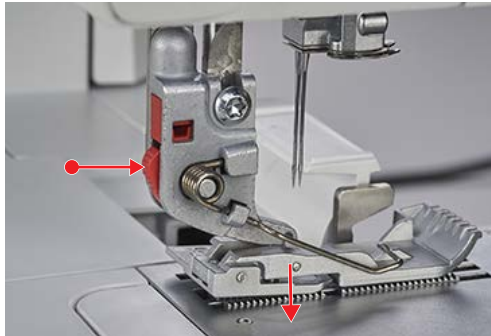

- > Lift the presser foot spring slightly and remove the presser foot.
- > Lift the presser foot spring slightly and place the new presser foot beneath the shaft groove so that the shaft groove lies exactly above the presser foot pin.
- > Lower the presser foot shaft carefully until the shaft groove engages with the presser foot pin.



- > Raise the presser foot.

3.5 Needle area

Needle holder

The needle holder can hold five needles. The machine is designed for needles of the ELx705 system. Needle sizes between 70 – 90 are to be used for this machine. (see page 63)



Needles for coverstitches



«LC» left coverstitch needle for coverstitches.

«CC» center coverstitch needle for coverstitches.

«RC» right coverstitch needle for coverstitches and chain stitches.

Needles for overlockstitches



«LN» left needle for overlock stitches.

«RN» right needle for overlockstitches.

Changing the Needle

The needle threader/insertor is located in the accessory holder on the threader cover. The use of the needle inserter is recommended and prevents the needle from falling into the feed dog area.

The needle holder screws must always be tightened, even if no needles are inserted, so falling out of the needle holder screws is excluded by vibration. Correctly inserted needles are not at the same height.

NOTICE

Damage due to excessive tightening of the screws

The needle screw threads may be damaged. A repair by the specialist retailer BERNINA is required.

> Do not overtighten the needle screws.

Prerequisite:

- The needles are in the top position.
 - The presser foot is raised and swung out.
- > Guide the needle inserter from below over the needle and loosen the needle screw using the supplied hex screw driver.



> Remove the needle downwards and place it in the needle box or needle pad behind the threader cover.

Setting up the machine

- > Insert the new needle with the flat side to the back into the needle inserter.



- > Push the needle into the corresponding needle holder opening as far as it will go.
- > Check the needle position in the needle checking window.



- > Tighten the needle screws.

Needle pad

The needle pad is located behind the threader cover and is used to store needles that are not being used.

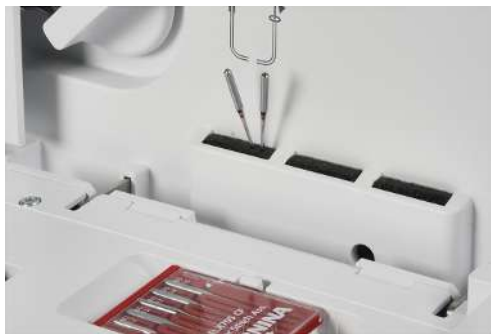

Threading the needle manually

With the needle inserter/threader every needle can be threaded easily.

- > Hold the needle threader with the triangular mark facing up.
- > Pull the thread horizontally through the Y-shaped slot and hold the end of the thread.

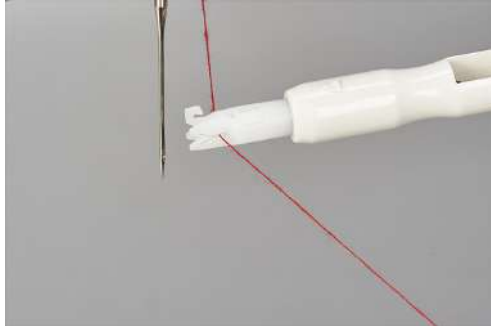

- > Place the needle threader with the triangular mark facing upwards on the needle and glide along the needle with light pressure towards to the needle eye.

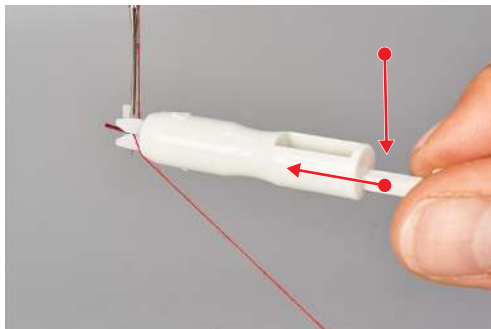

- The metal pin presses the thread through the eye of the needle.
- > Release the pressure on the needle threader and remove it from the needle.



- A thread loop has formed.
- > Use the hook of the needle threader to pull the thread loop to the back.



- > Place the thread beneath the presser foot to the back left.



Open/close the looper cover

The looper cover with integrated knife cover insert protects against injuries caused by the movement of the looper and knife movement as well as against dust and fabric scraps.

Prerequisite:

- Threader cover is opened.
- > To open the looper cover, push the tabbed handle to the right and then lower it to the front.



- > To close the looper cover, lift the tabbed handle upwards and let it slide back to the left slowly.



Removing/attaching the knife cover insert



Prerequisite:

- Looper cover is opened.
- Coverstitch insert is removed.



- > To insert the knife cover insert, push the knife cover insert into the snap-in opening.

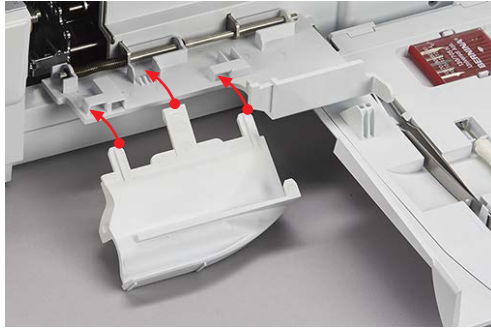

- > To remove the knife cover insert, pull the knife cover insert out of the snap-in opening.

Removing/attaching the coverstitch insert

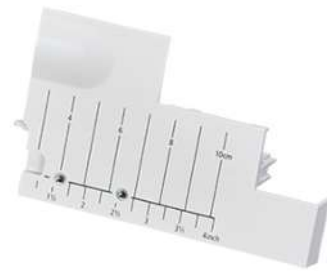

Prerequisite:

- Loper cover is opened.
- Upper looper is deactivated. (see page 76)
- Knife cover insert is removed.

- > To insert the coverstitch insert, push the coverstitch insert into the snap-in opening.

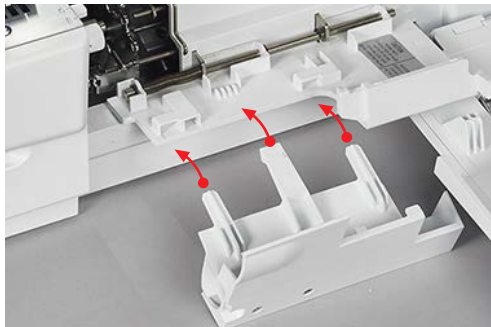

- > To remove the coverstitch insert, pull the coverstitch insert out of the snap-in opening.



Attaching/removing the frearm cover

The frearm is ideal when working with tubular, closed projects such as cuffs, trouser hems or sleeve ends. The frearm cover closes the gap between the stitch plate and the sewing surface.

Prerequisite:

- The slide-on table is removed.
- > To attach the frearm cover, push the frearm cover along the guide rails from the left until it engages.
- > To remove the frearm cover, pull the frearm cover to the left.



Attaching/removing the slide-on table

The slide-on table increases the sewing surface, especially helpful with larger sewing projects.

Prerequisite:

- The frearm cover is removed.
- > To attach the slide-on table, push the slide-on table along the guide rails from the left until it engages.

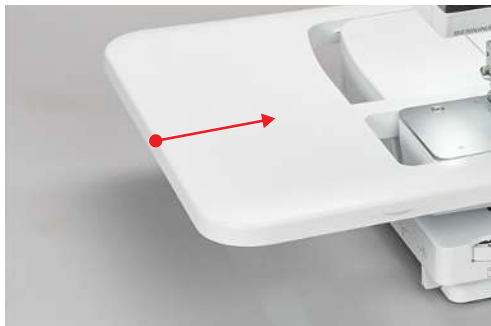

- > To remove the slide-on table, press the release mechanism (1) of the slide-on table and pull the slide-on table to the left.

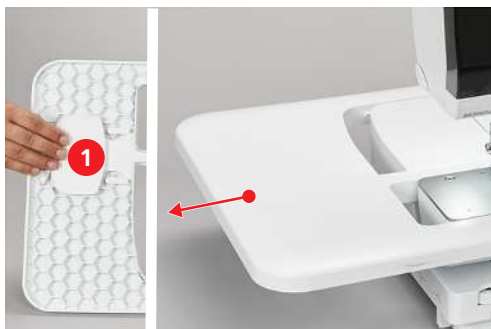

4 Setting up software

4.1 Setup Program



- | | | | |
|---|------------------------------------|---|------------------------|
| 1 | «Sewing speed» | 4 | «Firmware settings» |
| 2 | «Screen brightness / sewing light» | 5 | «Personal settings» |
| 3 | «Sound settings» | 6 | «Monitoring functions» |

Adjusting the sewing speed

The sewing speed of the machine can be preset.

The maximum sewing speed is achieved by pressing the foot control all the way down. The minimum sewing speed is achieved by pressing the foot control gently. (see page 41)



- | | | | |
|---|------------------------------------|---|------------------------------------|
| 1 | «Setting the maximum sewing speed» | 2 | «Setting the minimum sewing speed» |
|---|------------------------------------|---|------------------------------------|

> Preset the maximum sewing speed. (see page 28)

Adjusting screen brightness/sewing light

The screen brightness can be adjusted according to your own wishes.

If the sewing light has a disturbing effect on the project, the sewing light can be switched off and on again.



1 «Screen brightness»

2 «Sewing light on/off»

- > Preset the screen brightness. (see page 28)
- > Switch the sewing light on/off. (see page 28)

Activating the audio signals

Touches on the screen are indicated by a sound. The sound can be selected or muted at will.

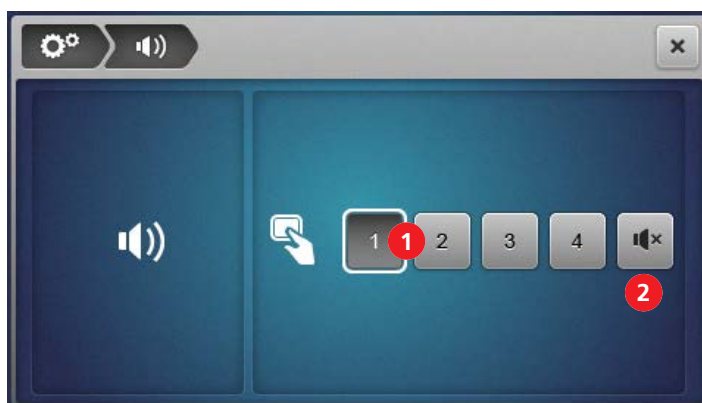

1 «Set sound» (1-4)

2 «Mute sound»

- > Select a sound type or switch to mute by tapping.

Setting up the firmware



- | | | | |
|---|--|---|----------------------------------|
| 1 | «Language selection» (see page 116) | 4 | «Factory setting» (see page 118) |
| 2 | «Information on the firmware version» (see page 117) | 5 | «Firmware update» (see page 119) |
| 3 | «Calibrating the screen» (see page 120) | | |

Personalize the sewing screen

Different colors can be assigned to the sewing screen for the two user modes «Guided mode» and «Expert mode». A wallpaper pattern can be selected, which is displayed for both user modes.

The entry of the welcome text appears only for a short time during the start-up of the machine.

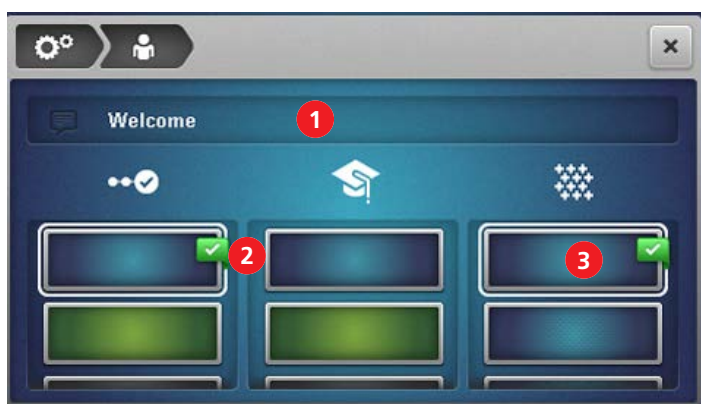

- | | | | |
|---|---|---|----------------------------------|
| 1 | «Welcome text» | 3 | «Wallpaper» of the sewing screen |
| 2 | «Background color» of the sewing screen | | |

Presser foot indicator

When the «presser foot indicator» is activated, an animation appears if the presser foot is not in sewing position. A warning signal is heard when the sound is on.



1 «Presser foot indicator»

4.2 Querying the Tutorial



> To get to the topic selection, tap the «Tutorial».

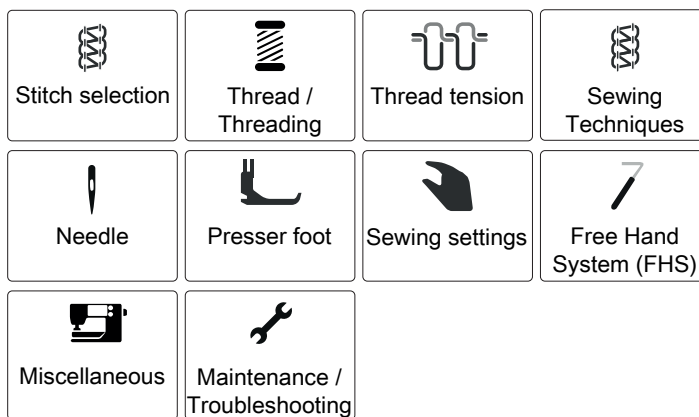

– An active progress navigation at the upper left edge of the screen serves as orientation.

> Select a subordinate topic until the desired information is obtained.

4.3 Activating the eco mode



> Press «eco».

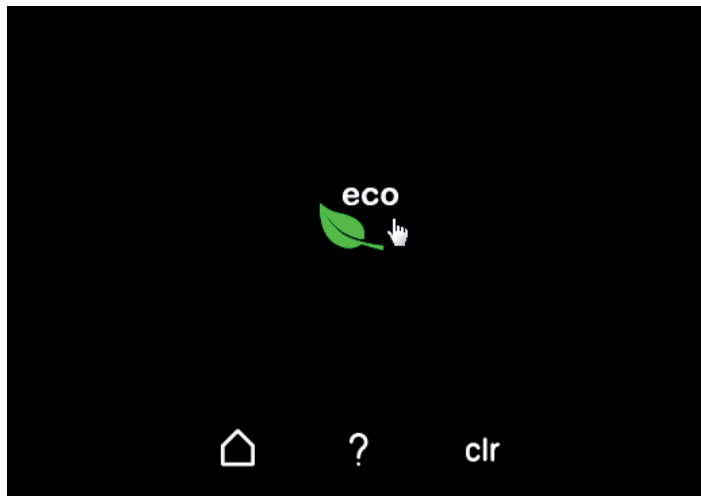

- The screen turns black and the eco mode symbol appears.
 - The sewing light switched off.
 - The machine is not ready for sewing.
- > Tap the icon «eco» on the screen.
- The Home screen appears.



5 Sewing start

5.1 Check before starting to sew

In order to start a project successfully, the following steps must be performed.

- The machine is switched on and the presser foot is lifted.
 - The fabric and the applications have been selected. (see page 61)
 - The thread has been selected. (see page 61)
 - The needle size matches with the thread type and the sewing project. (see page 62)
 - The stitch is selected. (see page 71)
 - The machine settings have been performed based on the stitch selection. (see page 74)
 - The threading has been performed. (see page 88)
 - All needle threads and looper threads lie under the presser foot to the back left.
 - The looper cover and the threader cover are closed.
- > Lower the presser foot.
- > Press the foot control to start the sewing process.
- A thread chain is formed.
 - If no thread chain is formed, the settings on the machine for the stitch must be checked.

5.2 Selecting the fabric

For a perfect sewing result, the quality of the needle, thread, fabric as well as the optimal stitch play a significant role.

- > It is therefore recommended to perform a sewing test with the selected fabric. (see page 103)

5.3 Selecting the thread

A wide range of sewing and special overlock threads are manufactured in various sizes and in different fiber combinations.

- The use of high quality overlock thread is recommended to achieve good results.
- Use thread cones/spools which are suitable for overlock machines.

NOTICE

Thread breakage due to incorrect needle/thread or thread/looper matching

The thread needs to glide smoothly through the respective thread guides.

It must be possible to feed the thread through the looper or the needle eye without any resistance.

Thread thick decorative threads exclusively into the loopers, use the air threader circumvention if necessary.

In the case of thick threads, elongate the stitch length and reduce the thread tension.



Selecting the needle thread

Needle size and thread type must be carefully matched. The correct needle size depends both on the selected thread type and the fabric to be sewn. The fabric weight and type determine the thread weight, needle size and point form.

Needle thicknesses of 70 - 90 can be used on the machine.

Thread type	Needle size
Polyester overlock thread No. 120	80 – 90
Polyester multifilament < No. 120	70 – 90
Wooly nylon	80 – 90
Decorative thread/yarn	80 – 90
Metallic thread	80 – 90

Check the needle/thread combination

	The needle/thread combination is correct, when the thread fits perfectly into the long groove and goes easily through the needle eye.
	The thread can break and skipped stitches can occur when there is too much clearance in the long groove and the needle eye.
	The thread can break and get stuck when the thread scrapes against the edge of the long groove not fit well into the needle eye optimally.

Selecting the looper thread

A wide variety of thread types can be used as looper threads. They can be threaded using the air threading system. The air threading circumvention must be used for thicker threads. (see page 92)

NOTICE

Damage by coated or waxed threads

Coated or waxed threads may lose some of their coating in the air threader pipes, resulting in permanent blocking of the pipes. Repair by a BERNINA dealer will be necessary. Avoid use of coated or waxed threads.

5.4 Selecting the needle

This machine is designed for needles of the system ELx705 with needle sizes 70 – 90. It is recommended to use the ELx705 CF (Chrome Finish) version as ELx705 CF needles are more durable. Due to the second thread groove, the machine runs most reliably with ELx705 CF needles.

If required, needles of the 130/705 H system can also be used. These universal needles can provide good results in certain applications and are available with various tip shapes and in different needle sizes.

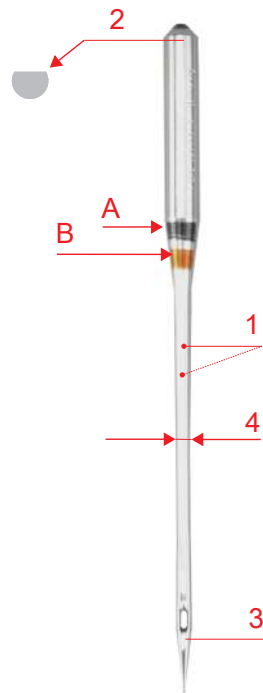

Fig. 1: Coverstitch needle ELx705 CF/80

A	■ Coverstitch needle ELx705 CF/80
1	double-groove
2	705 = Flat shank
3	CF = chrome finish
4 / B	80 = Needle size

The needles should be replaced regularly. Only a perfect needle point can achieve a proper stitch.

- Needle size 80: For any common applications. For mid-weight to heavy fabrics
- Needle size 90: For heavy fabrics
- Needle sizes > 80: In exceptional cases, only for light fabrics

Needle overview

Illustration	Name	Size	Description	Material/Application
 ■	Coverstitch needle ELx705 CF	80/12 90/14	Needle with two thread grooves	Overlock and coverstitch applications universal
 ■	Jersey needle ELx705 SUK CF	80/12 90/14	Mid-sized ball point	Overlock and coverstitch applications in knits and knitwear
 ☒	Universal needle 130/705 H	70/10 80/12 90/14	Slightly rounded point	For nearly all natural and synthetic fabrics (woven and knitted)
 ■	Stretch needle 130/705 H-S	75/11 90/14	Mid-sized ball point, special eye shape and groove	Jersey, tricot, knitted and stretch fabrics
 ■	Jersey/Embroidery needle 130/705 H SUK	70/10 80/12 90/14	Mid-sized ball point	Knitwear and embroidery
 ■	Jeans needle 130/705 H-J	80/12 90/14	Pointed, narrow point, reinforced shank	Heavy-weight fabrics such as jeans, canvas
 ■	Microtex needle 130/705 H-M	70/10 80/12 90/14	Especially sharp, narrow point	Micro fiber fabrics and silk
 ■	Quilting needle 130/705 H-Q	75/11 90/14	Slightly rounded, narrow point	Straight and topstitching
 ☒	Fine material needle 130/705 H SES	70/10 90/14	Small ball point	Fine knitwear, embroidering on fine, delicate fabrics
 ■	Metafil needle 130/705 H METAFIL	80/12	Long needle eye (2 mm) in all needle sizes	Sewing projects with metallic threads

*Not all needle sizes are available as BERNINA needles.

Detect defective needles

The needles should be checked every time before sewing and replaced if necessary.



1 Bent needles

3 Blunt needle

2 Damaged needle point

5.5 Fixing fabric layers

If several layers of fabric are sewn together, they can be fixed by basting stitches with the sewing machine or by pins.

- > To prevent damage to the knife or pins, place the pins approximately 2 cm from the edge of the fabric or remove them continuously while sewing.



6 Stitch

6.1 Stitch type

With this machine different stitch formations can be set. These stitches are achieved by different configurations of needles and mechanical settings.

Overlockstitch

The 3- and 4-thread overlock are considered standard overlock stitches for sewing two layers of fabric together, for finishing cut edges, e.g. facings, hem edges and seam allowances that are ironed apart.

The 2-Thread Overlock is ideal for finishing a fabric edge.

4-Thread Overlock

The 4-Thread Overlock is the most durable stitch thanks to the safety seam. The left and right overlock needle thread as well as the upper and lower looper thread are required for this stitch. The overlock needle threads form two parallel stitch rows, which on the front side look like step stitch rows of a sewing machine. On the wrong side, the overlock needle threads form «dots» to catch the under looper thread when the fabric is pierced, whereby the right overlock needle thread also serves as a safety seam.



3-Thread Overlock

The 3-Thread Overlock is usually stretchable than the 4-Thread. Therefore it is ideal for seams on knitted fabrics (LN wide) or fine fabrics (RN narrow).













2-Thread Overlock

The 2-Thread Overlock is formed with an overlock needle thread (LN wide or RN narrow) and the lower looper thread. The lower looper thread is guided to the right side of the fabric by means of the hooked-in upper looper converter. This overlock stitch is only suitable for edge finishing.

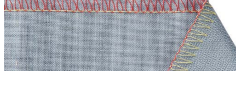

Edge serging

The finishing of a fabric edge is mostly used as preparation for open seams or as a decorative edge finish.

No.	Name	Stitch pattern
3	3-Thread Overlock Wide (LN)	
4	3-Thread Overlock Narrow (RN)	
8	3-Thread Rolled Hem	
9	2-Thread Wrapped Overlock Wide (LN)	
10	2-Thread Wrapped Overlock Narrow (RN)	
13	2-Thread Rolled Hem	
14	2-Thread Overlock Wide (LN)	
15	2-Thread Overlock Narrow (RN)	
28	2-Thread Blanketstitch Wide (LN)	
29	2-Thread Blanketstitch Narrow (RN)	
30	3-Thread Picotstitch	

Tab. 1: Recommended stitches for finishing a fabric edge





Seam

Seams are 2 or more layers of fabric, which are usually laid right side on right side and sewn together. There are two different types of seams.

- Closed seams
- Flat seams

Closed seam

3-Thread or 4-Thread Overlock stitches are suitable for closed seams, which loop around both fabric edges and sew them together. This stitch is mainly chosen for garments made of knitted fabrics and for wide cut garments made of woven fabrics.



No.	Name	Stitch pattern
1	4-Thread Overlock with safety seam	
2	3-Thread Super Stretch	
3	3-Thread Overlock Wide (LN)	
4	3-Thread Overlock Narrow (RN)	
7	3-Thread Narrow Seam	

Tab. 2: Recommended stitches for a closed seam

Flatlock for flat seams

The flatlock forms loops on the upper side of the seam and stitches on the underside.

- > Thread and set the machine for 2- or 3-Thread Flatlock.
- > Sew two layers of fabric together (wrong side on wrong side).
- > Carefully separate the two layers of fabric.
 - The two fabric edges now lie flat on top of each other at the stitch width of the flatlock.

No.	Name	Stitch pattern
5	3-Thread Flatlock Wide (LN)	
6	3-Thread Flatlock Narrow (RN)	

No.	Name	Stitch pattern
11	2-Thread Flatlock Wide (LN)	
12	2-Thread Flatlock Narrow (RN)	

Tab. 3: Recommended stitches for a flatlock

Coverstitch





Hem

Coverstitch hems on garments, having been sewn with the machine, look very professional.

3- / 4-Thread Coverstitch

The coverstitch consists of 2 - 3 needle threads on the right side and 1 looper thread on the wrong side of the fabric.

Cover and chainstitch seams allow the option to sew without cutting the edges. These seams can be used in many different ways, for both functional and decorative purposes: Seams, hems, bindings etc.

No.	Stitch name	Stitch pattern
21	4-Thread Coverstitch	
22	3-Thread Coverstitch Wide (LC-RC)	
23	3-Thread Coverstitch Narrow (LC-CC)	
24	3-Thread Coverstitch Narrow (CC-RC)	

Tab. 4: 3- / 4-Thread Coverstitch

Decorative seam

Coverstitches and chainstitches can be used for decorative sewing. The wrong side of the seam is especially attractive when multicolor thread is used in the looper.

Chainstitch

Basting

The chainstitch is ideal for basting, e.g. in the provisional assembly of garments for fitting, when sewing costumes or with alterations to be made. Due to the loop structure of the stitch, the seam can be undone simply by pulling the looper thread.

2-Thread Chainstitch

The 2-thread chainstitch looks like a straight stitch on the right side of the fabric, and on the wrong side it forms a chain. With a decorative thread in the chain looper and the needle, the chain stitch looks more distinctive and is more prominent. With such a chain looper/needle thread combination many creative possibilities are given. Due to the loop structure of the stitch, the seam can be undone simply by pulling the chain looper thread.



No.	Stitch name	Stitch pattern
16	2-Thread Chainstitch	

Tab. 5: Recommended stitches for a chainstitch

Combostitch

Seam

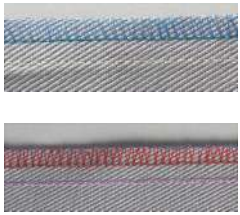
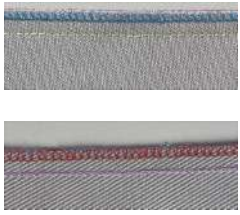
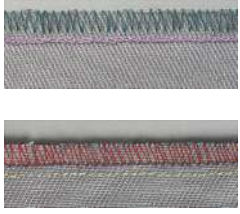
3-/2-Thread Overlock with Chainstitch



No.	Stitch name	Stitch pattern
17	3-Thread Overlock (LN) + Chainstitch (RC)	
18	3-Thread Overlock (RN) + Chainstitch (RC)	
19	2-Thread Overlock (LN) + Chainstitch (RC)	
20	2-Thread Overlock (RN) + Chainstitch (RC)	

Tab. 6: Recommended stitches for a durable closed seam



6.2 Stitch selection on the screen

There are three different options to select a stitch.

	Select a stitch from the «Stitch selection» in the sewing screen. (see page 71)
	In the sewing screen, select a stitch from the «Personal memory». (see page 72)
	In the Home screen, open the «Creative Consultant» for assistance. (see page 73)



When changing a stitch in the guided mode, a prompt appears asking whether the current stitch should be saved.

Selecting a stitch directly



Prerequisite:

- «Sewing screen» is active.
- > Select the «Stitch selection».



- > Select the «Stitch group».
 - An overview of stitches is displayed.
- > Select a «Stitch»
 - The wizard begins.
- > Den Instruktionen durch Weiterblättern folgen und Schritt-für-Schritt eine Einstellung nach der anderen ausführen.

The stitch selection with the preset expert mode omits the setup wizard and displays an overview of the manual settings to be made. (see page 35)

Selecting a stitch from the personal memory



- > Select the personal memory.
 - Stitches already saved are displayed.



- > Select the stitch by tapping on the icon.
 - The setup wizard starts.
- > Perform all settings for the selected stitch step by step on the machine and scroll to the next screen.
- > When all settings have been made, tap on «Confirm».
 - The stitch from the Personal memory is visible in the stitch view and ready to sew.

Stitch save/overwrite

In order for a stitch with changed settings to be saved/stored in the Personal memory, the stitch selection and its modification must already have been made.



From the guided mode, tapping on the personal memory automatically displays a query as to whether the stitch should be saved.

- > By «confirming» the query, the screen «Save the stitch» opens directly.
- > By «canceling» the query, the screen «Personal memory» opens directly.

Saving a stitch

- > Select the «Personal memory» and tap on «Save the stitch».
 - The stitch pattern is added to the selection without a stitch name.
- > Select a new stitch pattern.
- > Enter and confirm the stitch name using letters, numbers and symbols.
- > Add changed manual settings as a note and confirm.
 - The stitch is saved.
 - The last selected stitch is shown in the stitch view.

Overwriting a stitch

- > Select the «Personal memory» and tap on «Save the stitch».
 - The stitch image is added to the selection.
- > Select the stitch pattern of the stitch to be overwritten.
- > Confirm the query «Overwrite».
- > Check the stitch name, change it if necessary and confirm.
- > Add changed manual settings as a note and confirm.
 - The stitch is renamed.
 - The last selected stitch is shown in the stitch view.

Rename stitch



Prerequisite:

- The Personal memory is selected.
 - All saved stitches are listed.
- > Tap on «Rename a stitch».
 - > Select the stitch pattern with the stitch name to be changed.
 - The entry field for stitch naming appears.
 - > Change and confirm the new stitch name using letters, numbers and symbols.
 - The stitch name is changed in the personal.

Delete stitch



Prerequisite:

- The Personal memory is selected.
 - All saved stitches are listed.
- > Tap «Deleting a stitch».
 - The stitches in the memory that can be deleted are marked.
 - > Tap on the stitch pattern of the stitch to be deleted.
 - > Confirm the query «Delete» on the screen.
 - The stitch is deleted in the Personal memory.

Using the stitch recommendation of creative consultant



Prerequisite:

- The Home screen is selected.
 - The creative consultant is selected.
- > Select the fabric type.
 - > Select the application.
 - A matching stitch, presser foot, thread and needle are suggested.
 - > Reject the suggestion provided by creative consultant.
 - The home screen appears.
 - > Confirm the suggestion provided by creative consultant.
 - The setup wizard starts.
 - > Perform all settings for the selected stitch step by step on the machine and scroll up.
 - > By tapping on «Confirm», you also confirm that the settings have been made on the machine.

7 Machine settings

7.1 Preparing the machine for overlock or overlock/chainstitch combo



The machine can be set up for finishing the fabric edge with fabric cut with just a few movements.

Prerequisite:

- Looper cover is opened.
- > Set the «Upper looper on/off» to position «I». (see page 76)
- > Adjust the knife according to the stitch settings. (see page 74)
- > Knife cover insert is attached. (see page 50)
 - The machine is prepared for overlock or overlock/chainstitch combo.
- > Start sewing. (see page 61)

7.2 Preparing the machine for cover- and chainstitch



For hemming, basting or sewing together without cutting the fabric, the machine can be set up for coverstitch or chainstitch with just a few movements.

- > Set the «Upper looper on/off» to position «0». (see page 76)
- > Adjust the knife according to the stitch settings. (see page 74)
- > Coverstitch insert is attached. (see page 51)
 - The machine is prepared for a coverstitch or a chainstitch.
- > Start sewing. (see page 61)

7.3 Setting the knife

Knife on/off



For a better overview and better access in the sewing area, e.g. for threading, the knife can be lowered (off) and then engaged again (on). The knife is also lowered if the sewing project already has a clean cut edge and the edge is only to be finished. The best sewing results are achieved by cutting and finishing in one single step.

- > Push «Knife off» to the back.
 - The knife is lowered.



7.4 Setting the upper looper on/off



Activating the upper looper

Prerequisite:

- The looper cover and the threader cover are opened.
- > Set the «Upper looper on/off» to position «I».
- > Press the foot control.
 - The pulse drive is performed.
 - Upper looper is activated.



- > Attach the knife cover insert. (see page 50)



Deactivating the upper looper

Prerequisite:

- The looper cover and the threader cover are opened.
- The upper looper converter is hooked out. (see page 77)
- > Set the «Upper looper on/off» to position «0».
- > Press the foot control.
 - The pulse drive is performed.
 - Upper looper is deactivated.



- > Attach the coverstitch insert. (see page 51)

7.5 Upper looper converter hooked in/hooked out



By hooking in the upper looper converter, the upper looper grabs the lower looper thread so that it covers the entire fabric edge.

Prerequisite:

- The needles are in the top position.
 - Upper looper is in position «I».
 - The upper looper thread is removed.
 - The lower looper thread is below the upper looper.
- > To hook in the upper looper converter, swing the upper looper converter to the left at the retaining bracket.



- > Lightly press the upper looper converter back on the retaining bracket and hook the snap-in lug into the eye of the looper, making sure that the snap-in lug is completely engaged.

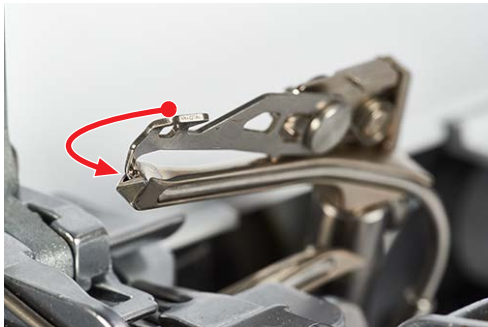

- > To unhook the upper looper converter, press the retaining bracket of the upper looper converter back slightly and remove the snap-in lug out of the looper eye.
- > Swing the upper looper converter completely back to the right.



7.6 Adjusting the thread tension

The thread tension has a considerable influence on each individual thread and its task to perform the stitch formation. The thread tension is preset for each stitch with a default value and does not have to be changed until the test sewing.

The thread tension can be changed while sewing.

- > To reduce the thread tension, set the thread tension fine adjustment to a lower value.
- > To increase the thread tension, set the thread tension fine adjustment to a higher value.



An adjustment of the stitch formation can primarily be achieved by reducing the thread tension.

The thread tension can be changed using the fine adjustment buttons «+»/«-» or in the stitch view. (see page 36)

- > By selecting the thread tension range, the thread tension can be adjusted individually for each thread path.



- > The slider control of each thread tension can be adjusted between 1 and 9.



- > Each individual thread tension can be adjusted between 1 and 9 using the fine adjustment keys «+/-». The alteration of the thread tension is visible on the screen.



Optimizing the thread tension for cover stitches

The thread tension should be reduced in the smallest possible steps from the basic value.

A blue ribbon indicates that the set value is in the experimental range. In rare cases this may lead to skipped stitches.



The stitch elasticity can also be increased by reducing the stitch length.

Resetting to default value

- > Select yellow outlined field
 - Thread tension is reset to the default value.
- > Touch the icon «clr»
 - All alterations on this screen are reset to the default value.

7.7 Adjusting the differential feed

 The differential feed prevents unwanted seam puckering or seam waves in knitted or stretchy fabrics as well as shifting of fabric layers. The rear feed dog always maintains the same speed, while the front feed dog can be adjusted. The two feed dogs can be geared to each other during the sewing process so that the fabric is fed as desired and no waves or unwanted puckering occur.



To enable a «blind operation», the setting range is displayed larger when the machine is running.

> Set differential feed proportion of the front feed dog via the differential feed setting.



Setting for the front feed dog	Fabric	Result
2	Fine, soft fabric	Ruffling, puckering, gathering
1,5	Jersey, sweatshirt, knits	Slight ruffling, preventing seam waving
1	Woven knit and medium weight dense fabric.	Default value
0,7	Fine nylon tricots, densely woven fabric, lining, satin	Stretching, preventing seam puckering

The setting describes the ratio of movement of front feed dog relative to the rear feed dog.

Default value 1



7.8 Setting the rolled hem selection lever «O/R»



The adjustment positions for overlocking «O» and rolled hems «R» are marked in the stitch plate and can be set for the desired application.



Overlocking «O»

During overlocking, the upper and lower looper threads are laid around the stitch finger and this creates an even distance to the cut edge.

> Move the rolled hem selection lever to position «O».



- Overlocking is activated.
- The stitch finger is extended.

If the thread quantity at the fabric edge is too much or too little, the thread quantity can be corrected by the mtc thread control. (see page 84)

Rolled hem «R»

By retracting the stitch finger, the loops of the upper and lower loopers thread are reduced and the fabric edge is rolled under. Rolled hems are the ideal edge finishing for fine fabrics. These are particularly suitable for decorative finishings on scarves, evening gowns, lingerie, home textiles and as lining seams.

> Move the rolled hem selection lever to position «R».

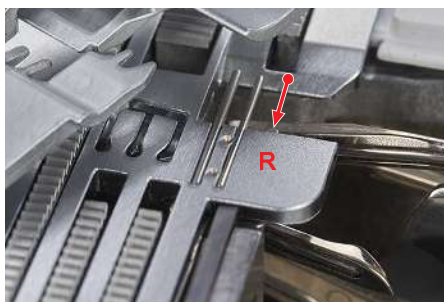

- The rolled hem is activated.
- The stitch finger is retracted.

7.9 Setting the mtc micro thread control

mtc By default mtc micro thread control is always set to position «0». mtc micro thread control affects the amount of looper threads around the fabric edge and can be adjusted continuously during sewing. This feature makes it easy to achieve the look of the stitch at any given cutting width.



The mtc is most effective when used for a cutting width of 6 – 8 mm.

Between 5 – 6 mm the adjustment towards the minus «-» direction is limited.

Between 8 – 9 mm the adjustment towards the plus «+» direction is limited.

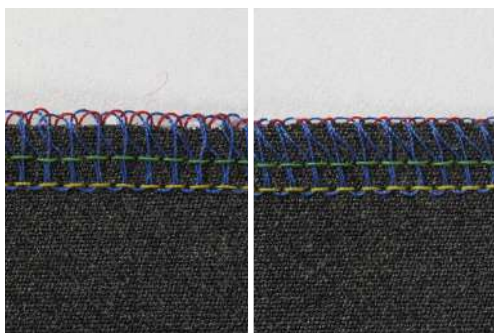

Prerequisite:

- The sewing test is performed.
 - The thread tension is set correctly.
 - The knife position is set correctly.
 - mtc (micro thread control) set to «0».
- > To enlarge the loops of the looper thread at the fabric edge, turn the mtc micro thread control during sewing in «+» direction.
- > In order to adjust the mtc thread control in «+» direction when the machine is at rest, the thread loops must be pushed off the stitch finger so that the movement of the stitch finger is not limited.

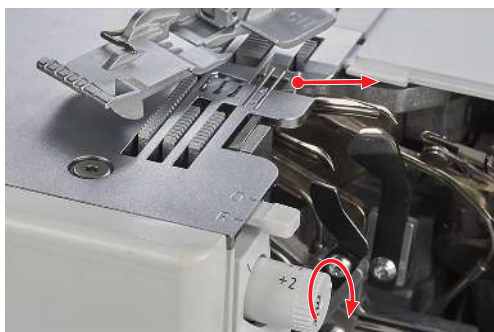

- > To minimize the loops of the looper thread at the fabric edge, turn the mtc micro thread control in «-» direction during sewing.



7.10 Setting the presser foot pressure



The presser foot pressure of the machine is set in the default value "4" so that it is suitable for sewing medium-weight fabrics. Most materials do not require any adjustment of the presser foot pressure. However, there are some cases where an adjustment is necessary, for example when sewing very light and heavy fabrics.



- | | | | |
|---|--------------|---|---------------|
| 1 | Extra light | 4 | Default value |
| 2 | Light | 5 | Medium high |
| 3 | Medium light | 6 | High |

- > To set the optimal presser foot pressure for your sewing project, perform a sewing test.
- > Reduce the presser foot pressure for light fabrics.
- > Increase the presser foot pressure for heavy fabrics.
- > To increase the presser foot pressure, set the presser foot pressure wheel to a higher value.



- > To reduce the presser foot pressure, set the presser foot pressure wheel to a lower value.



7.11 Adjusting the stitch width

- Needle position
- Cutting width

Changing the stitch width via the needle position



The stitch width can vary by the choice of needle position by 2 mm.

- > To sew a wide stitch, insert the left needle.
- > To sew a narrow stitch, insert the right needle.

Changing the stitch width via the cutting width



The stitch width can vary by adjusting the knife position. The scale of the cutting width dial determines the distance between the left overlock needle (LN) and the knife in mm. For the right overlock needle, the set scale value is reduced by 2 mm.

- > To adjust the stitch width, set the cutting width dial between 5 – 9 mm.

7.12 Adjusting the stitch length



The stitch length setting corresponds to the feed dog movement in mm.

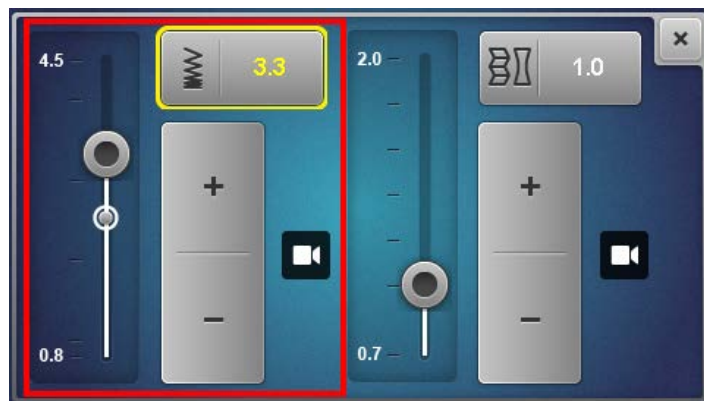

The common stitch length for overlock stitches is 2.5 mm, for coverstitches 3.5 mm and for combo stitches 3 mm. Stitch lengths of approx. 1 mm are e.g. used for rolled hems, while stitch lengths of approx. 4 mm are used for gathering or sewing on a elastic band. The stitch length can be infinitely adjusted between 0,8 – 4,5 mm while sewing.

- > Tap on the stitch length icon on the sewing screen.



To enable a «blind operation», the setting range is displayed larger when the machine is running.



Optimizing the stitch length for cover stitches

The stitch length should be reduced in the smallest possible steps from the basic value.

A blue ribbon indicates that the set value is in the experimental range. In rare cases this may lead to skipped stitches or problems with fabric feed occurs.



The stitch elasticity can also be increased by reducing the differential feed.

8 Threading

Due to the one-step BERNINA air threader, no specific sequence is required for threading the machine.

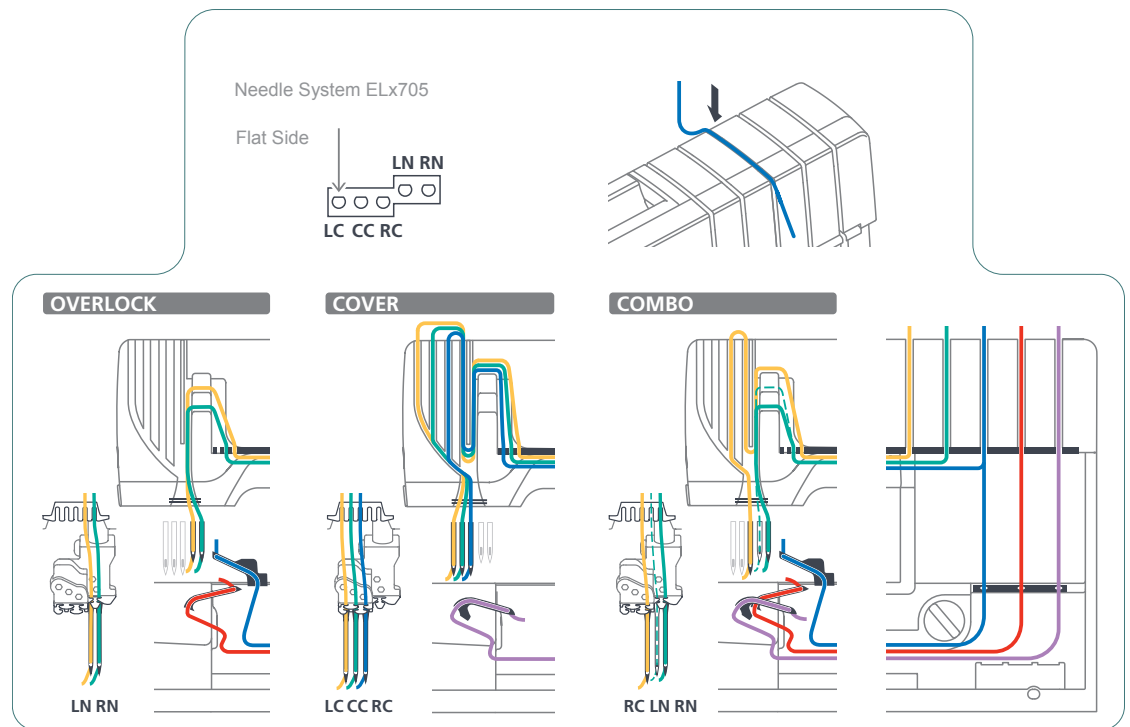

8.1 Preparing for threading

Perform the required mechanical settings for the stitch e.g. needle position, rolled hem selection lever and upper looper converter. Correct threading is ensured when following the color markings.

Prerequisite:

- Retractable thread guide fully extended.
 - The needles are in the top position.
 - All threads that are not needed for the particular stitch have been removed.
- > Raise the presser foot.
- The thread tensions are released. The thread can be inserted without resistance.
- > Place the thread cones on the respective spool pin.
- > Place the thread from the back through the corresponding color-coded thread guide.

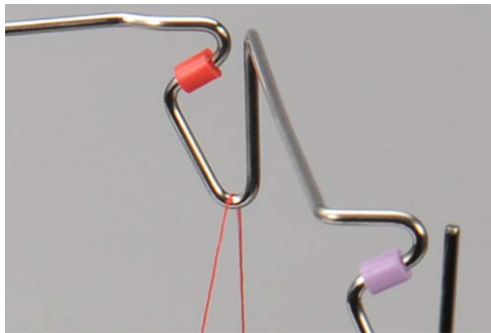

- > Engage the thread into the thread pretension with both hands downwards and check that the thread does not slip out of the thread pretension when pulling it up backwards.

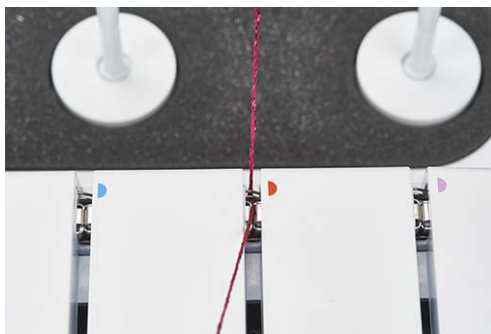

- > Place the thread along the threading slot between the thread tension discs.



8.2 One-step BERNINA air threader

NOTICE

Damage by coated or waxed threads

Coated or waxed threads may lose some of their coating in the air threader pipes, resulting in permanent blocking of the pipes. Repair by a BERNINA dealer will be necessary. Avoid use of coated or waxed threads.

The setting for the air threading is made by turning the air threader connection.



> Turn the air threader connection completely in the required direction.

Performing a pulse drive

A puls drive is a support function, allowing to move the main drive slowly while the covers are open. With this function the main drive moves to threading position or the upper looper is activated/deactivated.

NOTICE

Pulse drive

If the air threader pipes are not coupled, the puls drive will be performed by pressing the foot control.

The needles are brought into the top position and the coupling is complete.

Press the foot control again.

Threading or activating/deactivating upper looper can continue.

Threading the looper threads UL/blue, LL/red, CL/purple

Depending on the stitch, the upper looper (blue), the lower looper (red) and/or the chain looper (purple) are threaded.

Prerequisite:

- «Preparing for threading» has been performed.
- > Open the threader cover and the looper cover.
- > Set the air threader connector to «1». (see page 89)
 - The air threader pipes are coupled.
- > Hold the thread end above the respective air threader nozzle.



- > Pull a thread reserve of approx. 40 cm so that the thread can be completely drawn through the threading path.
- > To start the thread feed, press the foot control.
 - The looper thread is shot through the air threader pipe and exits at the looper tip.
- > As soon as the looper thread emerges out of the looper eye, release the foot control.



- > Place the upper and lower looper threads under the presser foot to the rear left.
- > Cut the chain looper thread back to 10 cm and leave in the looper area.
- > Set the air threader connector to «0».



- > Close the looper cover and the threader cover.

Circumventing the air theader

- ▶ Some thick or decorative threads cannot be threaded through the air threader nozzle or don't provide optimal stitch formations when these threads are threaded through the air threader pipes.
- ▶ Alternatively, such threads may be threaded through the air threader circumvention. This reduces the friction in the air threader pipes and results in a lower thread tension.

Prerequisite:

- The looper thread is threaded and can serve as auxiliary thread.
- > Open the threader cover and the looper cover.
- > Set the air threader connector to «0».
- > Using the tweezers pull the looper thread out of the air threader pipe exit creating a thread loop.

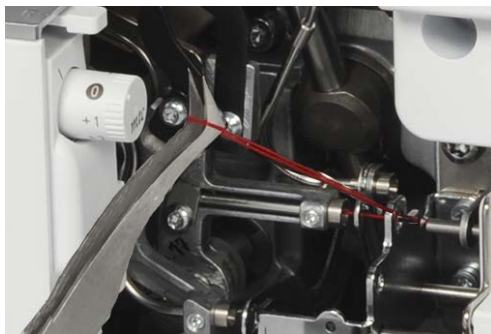

- > Cut the loop with scissors.



- > Replace the looper thread on the thread stand with the desired special thread.
- > Thread the special thread and guide it through the respective colored eyelet of the air threader circumvention.

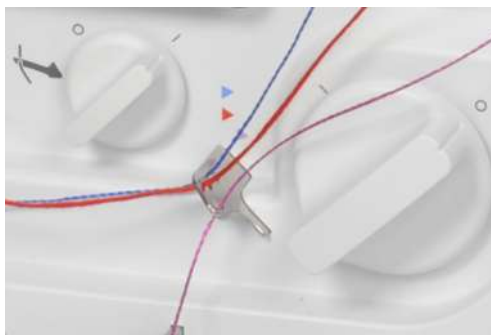

- > Tie the end of the auxiliary thread to the special thread from the air threader circumvention eye.



- > Pull the auxiliary thread until the knot emerges out of the looper eye.
- > Cut the knot.
 - The special thread is threaded as the new looper thread.

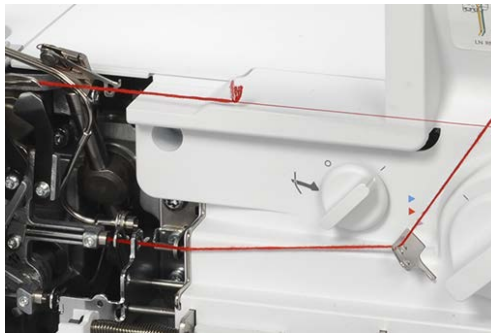

- > Place the looper thread under the presser foot to the rear left.



Using the threading wire

The threading wire can be used as a threading aid for the looper thread if the air threader doesn't work. The threading wire is a wear part and not designed as a permanent threading or cleaning aid.

NOTICE

Damage by improper use of the threading wire

The air threader pipes may be damaged. Repair by a BERNINA dealer will be necessary.

- > Insert and pull through the threading wire only in the thread flow direction.

Prerequisite:

- There is no thread in the respective air threader pipe.
 - «The threading preparation» has been performed. (see page 88)
- > Open the threader cover and the looper cover.
 - > Guide the threading wire with the end marked in red (threading wire loop upwards) through the corresponding air threader nozzle until it exits at the looper eye.



- > Pull the desired looper thread through the threading wire loop.



- > Pull the end of the threading wire until the looper thread emerges from the eye of the looper.



- > Place the looper thread under the presser foot to the rear left.

Threading the overlock needle thread RN/green

The thread path for the right overlock needle is marked in green.



For a combostitch with the left overlock needle LN, the green thread path is to be used.

Prerequisite:

- «Preparing for threading» has been performed. (see page 88)
 - The presser foot is swung out. (see page 43)
- > Pull the thread beneath the thread guide plate to the left and through the green marking of the thread deflection finger.



> Place the thread over the green thread take-up lever cover of the overlock needle and pull it down.



- > Pull the thread in the 1st position from the right through the thread guide.
- > Hook the thread into the thread guide on the needle holder, corresponding to the needle used.

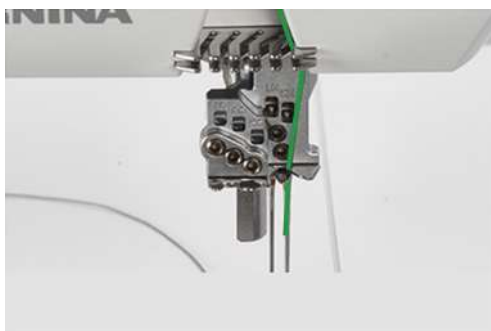

- > Thread the right overlock needle (RN).
- > Place the needle thread under the presser foot to the rear left.



Threading the coverstitch needle thread left LC/yellow

☺ The thread path for the left coverstitch needle is marked in yellow.

Prerequisite:

- «Preparing for threading» has been performed. (see page 88)
 - The presser foot is swung out. (see page 43)
- > Pull the thread beneath the thread guide plate to the left and through the yellow marking of the thread deflection finger (1).
- > Place the thread over the thread take-up lever cover of the coverstitch needle (2) and pull it down.
- > Pull the thread around the thread take-up guide (3) upwards and pull it in the LC coverstitch thread slot (4) towards the needle.



- > Pull the thread in the 1st position from the left through the thread guide (5).
- > Hook the thread into the thread guide on the needle holder, corresponding to the needle used (6).

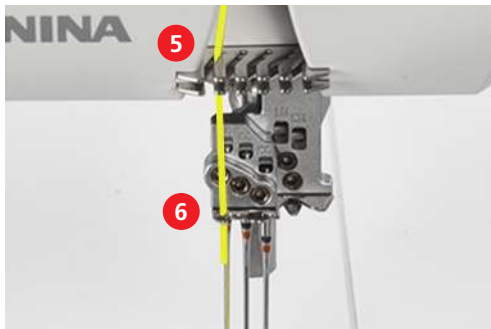

- > Thread the left coverstitch needle (LC).
- > Place the thread beneath the presser foot to the back left.

Threading the coverstitch needle thread center CC/green

The thread path for the center coverstitch needle is marked in green.



For a chainstitch with the center cover needle CC, the yellow thread path is to be used.

Prerequisite:

- «Preparing for threading» has been performed. (see page 88)
- The presser foot is swung out. (see page 43)
- > Pull the thread beneath the thread guide plate to the left and through the green marking of the thread deflection finger (1).
- > Place the thread over the thread take-up lever cover of the coverstitch needle (2) and pull it down.
- > Pull the thread around the thread take-up guide (3) upwards and pull it in the CC coverstitch thread slot (4) towards the needle.



- > Pull the thread in the 2nd position from the left through the thread guide (5).
- > Hook the thread into the thread guide on the needle holder, corresponding to the needle used (6).

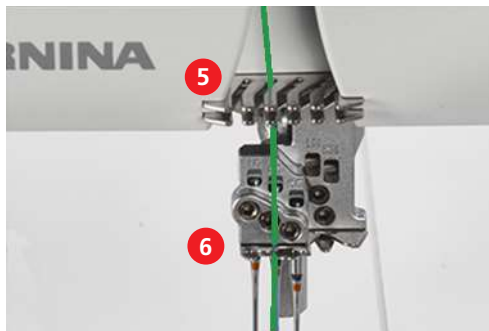

- > Thread the center coverstitch needle (CC).
- > Place the thread beneath the presser foot to the back left.

Threading the right coverstitch needle thread RC/blue

The thread path for the right coverstitch needle is marked in blue.



For a chainstitch using the right coverstitch needle RC the yellow thread path is to be used.

Prerequisite:

- «Preparing for threading» has been performed. (see page 88)
- The presser foot is swung out. (see page 43)
- > Pull the thread beneath the thread guide plate to the left and through the blue marking of the thread deflection finger (1).
- > Place the thread over the thread take-up lever cover of the coverstitch needle (2) and pull it down.
- > Pull the thread around the thread take-up guide (3) upwards and pull it in the RC coverstitch thread slot (4) towards the needle.



- > Pull the thread in the 3rd position from the left through the thread guide (5).
- > Hook the thread into the thread guide on the needle holder, corresponding to the needle used (6).

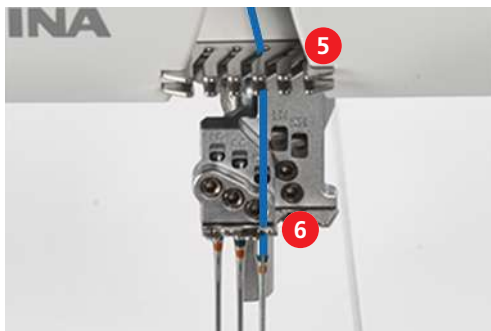

- > Thread the right coverstitch needle (RC).
- > Place the thread beneath the presser foot to the back left.

8.4 Changing the thread

Tying on threads is often used for changing needle thread or looper thread. (see page 101)

Friction can be reduced by keeping the knotted area as tight as possible.

NOTICE

Pulling a thread tie through the needle eye

The needle can be bent. A bent needle affects the stitch formation.

- > Cut the tie in front of the needle eye and thread the needle individually.

Knotting thick thread

- > Form a loop with the thin thread.
- > Insert the thick thread end from below into the thin thread loop.
- > Pass the thick thread to the back around both thin threads and guide it through the loop from above.

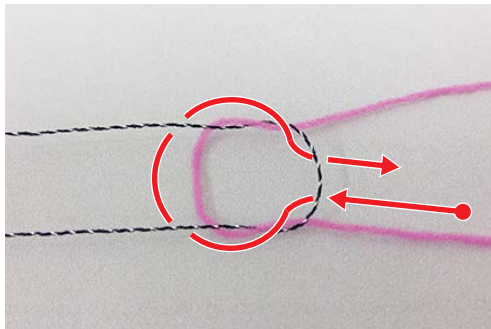

- > Hold both thread ends and pull them apart.

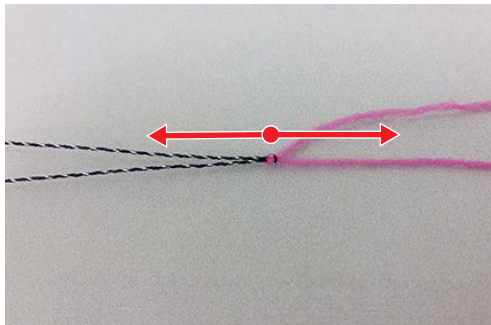

Changing the needle thread

NOTICE

Pulling a thread tie through the needle eye

The needle can be bent. A bent needle affects the stitch formation.

> Cut the tie in front of the needle eye and thread the needle individually.

> Cut the thread above the thread cone.



> Change the thread cone.

> Tie the threaded thread to the new thread. (see page 100)



> Pull the threaded end of the thread until the newly knotted thread is in front of the needle eye.

> Cut off the new thread behind the knotting.



> Remove the excess thread from the needle eye.

> Thread the new thread.

> Place the thread under the presser foot to the left.

Changing the looper thread

- > Cut the thread above the thread cone.
- > Change the thread cone.



- > Tie the inserted looper thread to the new thread.

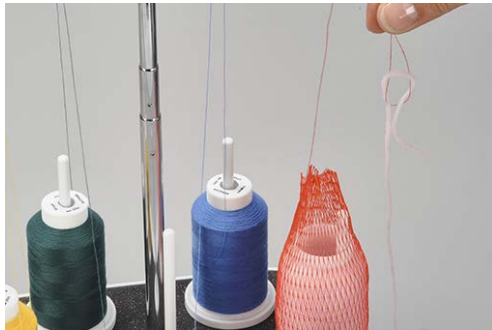

- > Pull the end of the thread out of the looper eye until the knot emerges.

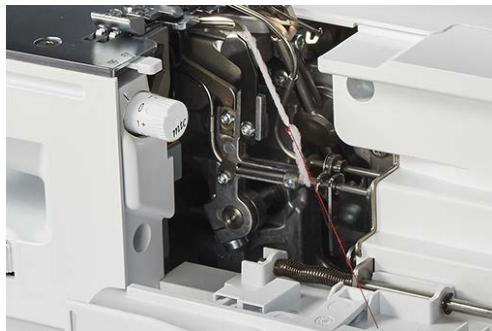

- > Cut the knot.
- > Place the thread under the presser foot to the left.



9 Sewing test

To check the optimal setting, a test sample should be sewn on a spare piece of the fabric used for your project.

The default values of the stitches represent recommendations that work for most standard applications. Depending on the sewing test, adjustments for stitch optimization are possible after the sewing test.

9.1 Performing a sewing test for an overlock stitch

Prerequisite:

- The «Sewing start» has been performed. (see page 61)
- > Place the fabric under the presser foot to the front of the knife so that the desired seam allowance is cut off.
- > Press the foot control and sew slowly. Guide the fabric gently as the machine automatically transports the material.
- > Sew beyond the fabric end such that a thread chain is formed.
- > Pull the thread chain over the thread cutter.
- > Assess the sewing test and make any necessary adjustments until the stitch setting matches the material combination.

The stitch optimizer provides assistance to obtain a perfect stitch appearance. (see page 104)

9.2 Performing a sewing test for an coverstitch

Prerequisite:

- The «Sewing start» has been performed. (see page 61)
- > Raise the presser foot.
- > Place the fabric under the presser foot such that the presser foot lies completely on the fabric.
- > Lower the presser foot.
- > Press the foot control and start sewing slowly. Guide the fabric gently as the machine automatically transports the material.
- > Do not sew beyond the end of the fabric.
- > At the end of the fabric, use the «Back-kick» function to raise the needle holder.
- > Raise the presser foot.
- > Pull the needle thread between the fabric and the presser foot to the left with the coverstitch look tool and cut it.
- > Pull the sewing project to the back left and cut the looper thread.
 - The seam end is secured.
- > Assess the sewing test and make any necessary adjustments until the stitch setting matches the material combination.

The stitch optimizer provides assistance to obtain a perfect stitch appearance. (see page 104)

9.3 Performing a sewing test for an chainstitch

Prerequisite:

- The «Sewing start» has been performed. (see page 61)
- > Raise the presser foot.
- > Place the fabric under the presser foot such that the presser foot lies completely on the fabric.
- > Lower the presser foot.
- > Press the foot control and sew slowly. Guide the fabric gently as the machine automatically transports the material.

- > Sew beyond the fabric end such that a thread chain is formed.
- > Raise the presser foot.
- > Pull the sewing project to the back left and pull the threads over the thread cutter.
 - The seam end is secured.
- > Assess the sewing test and make any necessary adjustments until the stitch setting matches the material combination.

The stitch optimizer provides assistance to obtain a perfect stitch appearance. (see page 104)

9.4 Stitch optimizer

The stitch optimizer provides assistance to obtain a perfect stitch appearance.

Prerequisite:

- The sewing test was performed.
- > Tap the «Stitch optimizer».
 - Pictures of faulty stitches can be selected.



- > Compare the sewing test and tap on the matching stitch picture.
 - Corrective measures are proposed.

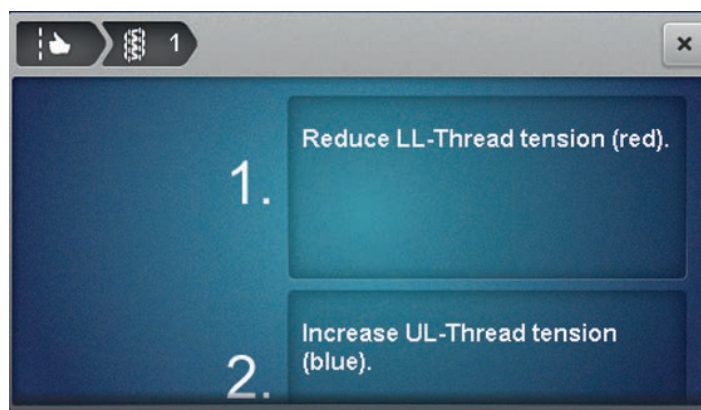

- > After each adjustment, evaluate the test sample and repeat the procedure until the perfect stitch formation is achieved.

10 Practical overlocking

In this chapter the most important applications for a successful sewing project are described. More advanced sewing techniques are described in the BERNINA Overlocker Reference book and can be purchased from specialist retailers.

10.1 Securing overlock stitches

The stitches are secured when they are overstitched.

Securing stitches is particularly important when seam ends are not secured by other seams or hems.

Sewing in the overlock chain at the start of the seam

- > Form a thread chain at a length of 5 - 8 cm.
- > Place the fabric under the presser foot and sew a stitch into the fabric.
- > Lower the needle via the «Back-kick» function.
- > Raise the presser foot.
- > Now pull the thread chain carefully forward and place it on the seam line to be sewn.
- > Lower the presser foot.
- > Sew approx. 4 cm over the thread chain.



Sewing in the overlock chain at the end of the seam

- > At the end of the seam, sew one stitch over the fabric edge.
- > Raise the needle.
- > Raise the presser foot.
- > Pull the fabric a bit backwards.
- > Turn the fabric so that the wrong side points upwards.
- > Place the fabric beneath the presser foot so that the needles pierce the fabric at the first stitch.
- > Lower the presser foot.
- > Sew approx. 1.5 - 2.5 cm over the seam and make sure not to cut the existing seam.
- > Finish the seam by sewing into the air.



- > Remove the left overlock needle thread in the same way.
 - The looper threads lie around the fabric edge and can be removed easily.



10.3 Securing cover- and chainstitches

The stitches are secured when they are overstepped. Securing stitches is particularly important when seam ends are not integrated with other seams or hems.

Securing cover- and chainstitches at the start of the seam

With cover- and chainstitches, the first stitch is automatically secured by the following stitches.

Securing coverstitches at the seam end

- > Sew the hem or the seam. When sewing in a circle, sew the last stitches over the first stitches.
- > Raise the needles and the presser foot.
- > Pull the needle threads between the presser foot and the fabric to the back with the Coverstitch look tool and cut them.

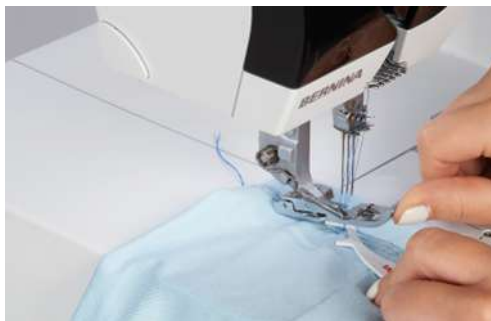

- > Pull the fabric to the back and cut the looper thread.
 - The stitches are secured.

10.6 Sew blanket stitch

The Blanketstitch is similar to the popular Parisian stitch and suits as edge finishing on woollen blankets, scarves or thick materials.

- > Preferably thread decorative threads into the looper and the needle.
- > Place water-soluble stabilizer on top of the fabric along the fabric edge.
- > Sew along the fabric edge.

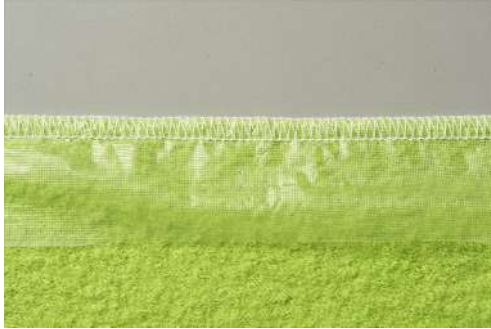

- > After sewing, pull the stabilizer away from the fabric, and in doing so, the needle thread is pulled to the edge of the fabric.
 - This makes the seam look like the typical hand-stitched blanket stitch.



- > Wash out the water-soluble stabilizer.

10.7 Gathering

Ruffling is a gathering or puckering of a seam.

Increasing the differential feed

- > Set the machine for a 4-Thread Overlock stitch.
- > Set the differential feed to «2».
- > Set the stitch length to «4,5».
- > Sew the fabric with this side up on which the ruffling is wanted.
- > Sew off the edge of the fabric.



Pulling the needle thread



Slightly different colors of the needle/looper threads facilitates separating the needle threads.

The needle threads are usually the shorter ones in the thread chain.

- > Set the machine for a 4-Thread Overlock.
- > Set the differential feed at default value.
- > Sew the fabric with this side up on which the ruffling is wanted.
- > Leave a long thread chain at seam end.
- > Separate the needle thread/threads from the thread chain.
- > Pull the needle thread(s) and evenly spread the puckers along the seam.



10.8 Sew outer corners

Method 1

- > Set the machine for a 2-, 3- or 4-Thread Overlock.
- > Sew along the edge of the fabric beyond the corner.
- > Start a new edge and sew over the previously sewn edge.
- > Secure the thread chain. (see page 106)



Method 2

- > Trim the seam allowance for the cutting width of the following corner in the sewing direction (presser foot length).

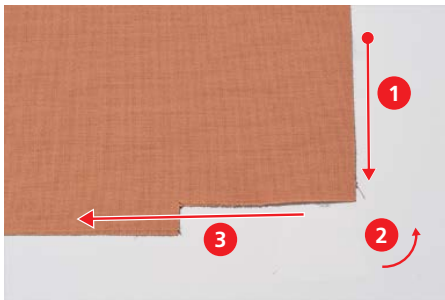

- > First sew the edge up to the cut corner.
- > Sew one stitch beyond the fabric edge and stop.
 - The needles are in the top position.
- > Raise the presser foot.
- > Move the rolled hem selection lever to position «R».
 - The thread loops are loosened from the stitch finger.
- > Turn the fabric counterclockwise.
 - The trimmed edge of the fabric is in the sewing direction under the presser foot.
- > Push the rolled hem selection lever to position «O».
- > Insert the needle into the fabric using the «Back-kick» function.
- > Pull back and tighten loose threads of the thread spools on the thread spool stand.
- > Lower the presser foot and continue sewing.



- > Lower the presser foot and continue sewing.



10.10 Sewing inner curves

Inner curves appear on necklines, facings and armholes. Time-consuming clipping or trimming can be avoided by overlocking the fabric edge.

- > Set the machine for a 3- or 4-Thread Overlock.
- > While sewing, stretch the curve carefully so it is straight.



10.11 Sew outer curves and circles

Due to the differential feed, the seam can be pulled or pushed into shape for flat, round edges.

- > Cut away the seam allowance in one place, at the length of the presser foot.



- > Start and end the seam at the cut seam allowance.
 - if seam waving out happens: set the differential feed to 1,5 – 2.
 - if puckering happens: set the differential feed to 0,7 – 1.
- > At the seam end, sew 1 – 2 stitches over the seam beginning.
- > Insert the needle and raise the presser foot.

- > Turn the fabric away from the presser foot to the left.



- > Lower the presser foot and sew over and beyond the fabric.

10.12 Sewing a hem

Coverstitch is ideal for hems in stretchy and knit material.

Prerequisite:

- The machine is set for a coverstitch.
- > Mark the hem depth (wrong side on wrong side) and press the hem.
- > the fabric under the presser foot, right side up.
- > Guide the edge of the hem along one of the markings on the coverstitch insert and sew.
 - The hem is sewn and finished on the wrong side at the same time.



- > Cut back any excess seam allowance.

10.13 Flat joining seams

- > Thread and set the machine for a cover- or chainstitch.
- > Adjust the stitch length suitable for the fabric.
- > Place the fabric under the presser foot and lower the presser foot.
- > Sew the seam.
- > To sew parallel lines or pintucks, use either the left or the right edge of the foot or the scale on the coverstitch insert.



11 Care and maintenance

11.1 Firmware

Selecting a language

By selecting one of the languages listed, all displays and assistance are changed accordingly. (see page 27)



Information on the firmware

This screen allows the dealer to gather important information about the machine.

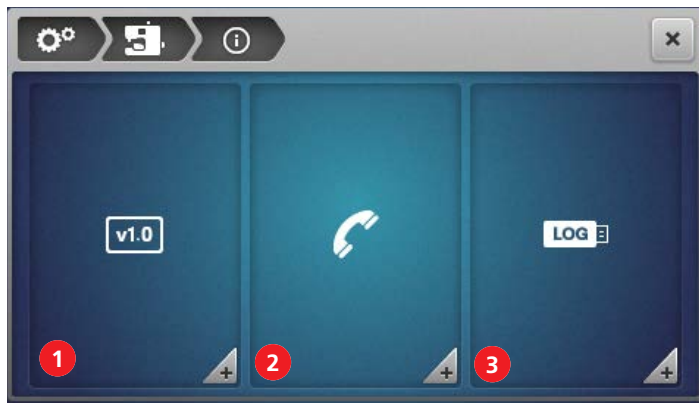

- 1 «Firmware version»
- 2 «Dealer data»
- 3 «Service data»

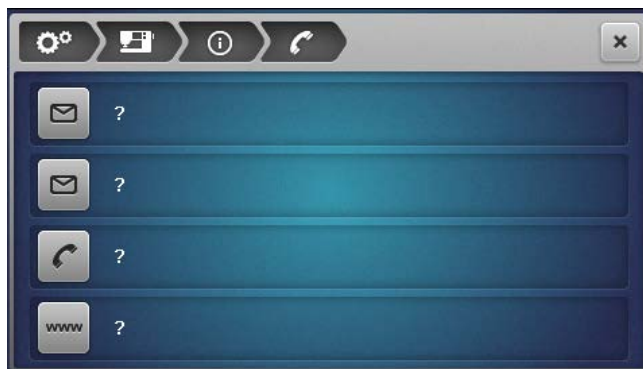

Restore factory settings

The factory settings are used to reset the software to the delivery state. All saved data will be deleted and cannot be restored. If the data from the personal memory should still be available, it must be backed up to the USB stick. (see page 119)



1 «Deleting the personal memory»

2 «Factory setting»

- > To delete **only** the contents of the personal memory, tap on icon (1) and confirm the deletion process.
- > To delete **all** data (personal memory and system memory), tap on field (2) and confirm the deletion process.

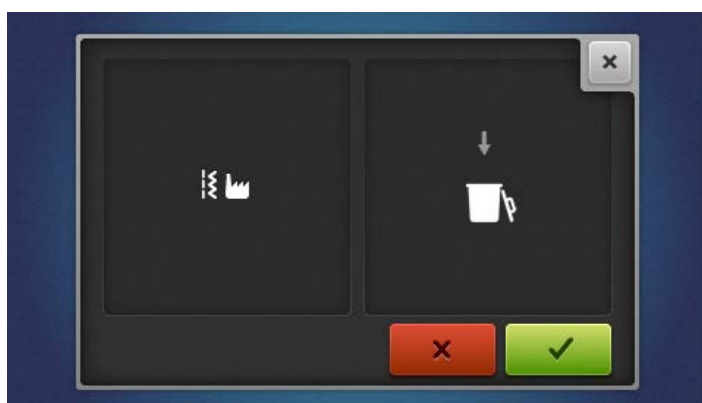

Starting the firmware update

Prerequisite:

- The latest firmware version is unpacked according to the firmware update installation instructions and saved on the USB stick.
 - Personal data (if desired) are saved on the USB stick before the update.
- > Insert the USB stick into the port.
> Tap on «update».



- Wait until the firmware update has finished.

NOTICE

Incomplete update due to removing the BERNINA USB stick too early

If the software has not been updated or has not been fully updated, the machine cannot be used.

- > Remove the BERNINA USB stick only once the update has been successfully completed.

- > Import the saved data, if available.
> Remove the USB stick.

Calibrate screen

The purpose of screen calibration is to tell the screen where the correct touch points are. This can be done especially when the screen stops responding properly when touched.

- > Tap on Calibrate screen.
– A screen with a crosshair appears.
> Use the touchpen to tap exactly on the intersection of the crosshairs.



- > Repeat this process until the crosshairs no longer appear.

11.2 Machine

Cleaning the machine

The service life of the machine depends on the care and maintenance. The machine can be cleaned with a damp cloth without detergent. Based on normal household use, an annual service at a certified BERNINA dealer is recommended.

NOTICE

Damage by cleaning with compressed air

Cleaning using aerosol sprays or compressed air may cause permanent damage to your machine. Repair by a BERNINA dealer will be necessary.

> Remove fabric scraps and thread remnants using a vacuum cleaner with soft tip.

> Free the looper area regularly from dust, fabric and thread scraps.

- Needle, needle bar
- Presser foot
- Feed dog (from above)
- Knife
- Freearm interior
- Screen

Recommended aids for cleaning:

- Brush
- BERNINA tweezers
- Vacuum cleaner with soft attachment

Cleaning the looper area

Dust, fabric and thread remnants accumulate in the looper area during overlocking and these should be removed regularly.

Prerequisite:

- The presser foot is raised.
 - The needles are in the top position.
 - Switch the machine off.
- > Remove the presser foot.
- > Remove the screws of the stitch plate with the Torx screwdriver.
- > Remove the stitch plate from the freearm.



- > Remove the cleaning cover on the freearm.

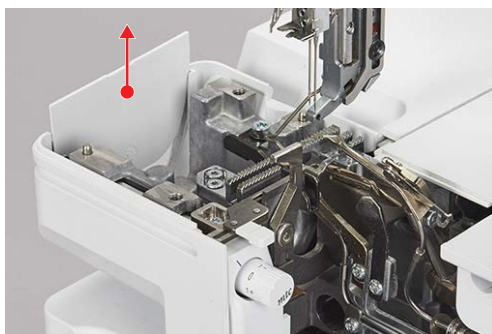

- > Remove dust, fabric and thread remnants with the brush or a vacuum cleaner.



- > Insert the cleaning cover.
- > Attach the stitch plate and screw on.
- > By slowly turning the handwheel, ensure that the knife, the needle and the feed dogs are not impeded in their movement.

Cleaning the air threader pipes

NOTICE

Damage by fluids in the air threader system



The air threader pump may be damaged permanently if liquids infiltrate the system. Repair by a BERNINA dealer will be necessary.

- > Protect the air threader nozzles from liquids.

Regularly remove dust and thread remnants from the air threader pipes.

Prerequisite:

- Use a thick thread (e.g. Amann Saba C size 30) at a length of about 1 m.
- > Thread the thread in the air threader nozzle.
- > To clean the air threader pipe, hold the thread at both ends and pull it to and fro.
- > Remove the thread at the looper end in thread feed direction.
- > Repeat this procedure for further air threader nozzles using a clean thread.

Cleaning the screen

- > Wipe the screen with a soft, slightly damp microfiber cloth.

Cleaning the suction feet

Cleaning the suction feet prevents the machine from slipping on the table at high sewing speed.

- > Remove dust and thread remnants from the suction feet with a damp cloth.

Oiling the machine

- > After frequent use, lubricate the upper looper joint with 1 – 2 drops of the supplied BERNINA overlock oil.



12 Errors and faults

12.1 Troubleshooting

Fault	Cause	Solution
Screen reacts poorly to touch	Screen is misaligned	> Calibrate the screen. (see page 120)
The stitch is irregular	The thread tension is incorrect.	> Adjust the thread tension. (see page 78)
	The needle size is incorrect.	> Match the needle size with the fabric/thread. (see page 62)
	Threading is incorrect.	> Rethread the machine. (see page 87)
	Fabric has been pulled.	> Don't pull the fabric; guide lightly.
	The presser foot is loose.	> Attach the presser foot properly. (see page 44)
	Air threader pipes are dirty.	> Clean the air threader pipes. (see page 122)
Needle breaks	The needle is defective.	> Replace needles. (see page 45)
	Fabric has been pulled.	> Don't pull the fabric; guide lightly.
	The needle size is incorrect.	> Replace the needle. (see page 45)
	The needle fit is incorrect.	> Match the needle size with the fabric/thread. (see page 63)
	The presser foot is loose.	> Attach the presser foot properly. (see page 44)
	The needle system is incorrect.	> Insert needle of the system ELx705 HAx1 CF. (see page 63)
Puckering is not wanted	The thread tension is incorrect.	> Adjust the thread tension. (see page 78)
	Needles are defective.	> Insert a new needle. (see page 45)
	The differential feed is incorrect.	> set the differential feed to 0.7 – 1. (see page 80)
Waving is not wanted	The differential feed is incorrect.	> set the differential feed to 1 – 2. (see page 80)
Skipped stitches	The needle size is incorrect.	> Match the needle size with the fabric/thread. (see page 63)
	Threading is incorrect.	> Rethread the machine. (see page 87)
	The needle is defective.	> Insert a new needle. (see page 45)
	The needle fit is incorrect.	> Insert the needle correctly. (see page 45)

Fault	Cause	Solution
Thread breakage	Threading is incorrect.	> Rethread the machine. (see page 87)
	The needle is bent.	> Insert a new needle. (see page 45)
	The thread tension is incorrect.	> Adjust the thread tension. (see page 87)
	The upper thread is tangled.	> Check the thread spool. (see page 38)
	Retractable thread stand is not fully extended.	> Raise the retractable thread stand fully. (see page 38)
The machine doesn't sew	No power supply.	> Connect the machine. (see page 37)
	The main power switch is switched off.	> Switch the machine on. (see page 37)
	Machine is overheated.	> Switch the machine off and let it cool down for 10 - 15 min. (see page 37)
Fabric piles up	The presser foot pressure is incorrect.	> Reduce the presser foot pressure. (see page 85)

13 Storage and disposal

13.1 Storing the machine

The correct storage of the machine over a longer period of time has an influence on its lifespan and functionality.

- > Don't store the machine outdoors.
- > Protect the machine against climatic influences.
- > Before operating the machine again after storage, leave the machine unpacked for approx. 1 h at room temperature.

13.2 Transporting the machine

For a relocation or a longer transport of the machine, the following actions should be carried out.

- > Retract the retractable thread guide of the thread stand completely downwards.
- > Lower the presser foot.
- > Remove all connecting cables.
- > Lift and transport the machine at the carry handle and the transport carry groove under the handwheel.

13.3 Dispose of the machine

BERNINA International AG is committed to environmental protection. We make every effort to increase the environmental friendliness of our products by continually improving their design and production technology.

If the machine is no longer required, dispose of it in an environmentally friendly way in accordance with the national guidelines or take it to the nearest BERNINA specialist shop. Do not dispose of the machine in the household waste.

14 Technical data

Name	Value	Unit
Number of stitches	27	
Number of loopers	3	
Number of needle positions	1 – 5	
Needle system	ELx705 CF	
Needle size	70 – 90 (10 – 14)	
Differential feed	0,7 – 2	
Maximum fabric thickness	6 (0,41)	mm (in)
Stitch length	0,8 – 4,5 (0,03 – 0,18)	mm (in)
Cutting width from the left overlock needle LN	5 – 9 (0,19 – 0,35)	mm (in)
Cutting width from the right overlock needle RN	3 – 7 (0,11 – 0,27)	mm (in)
Sewing speed	250 – 1'350	Stitches per minute
Dimension without retractable thread stand	43 x 28 x 41 (16,92/11,02/16,14)	cm (in)
Dimensions with sewing table / cut-offs bin	57 x 35 x 65 (22,44/13,78/25,59)	cm (in)
Weight of the machine	13,4 (29,54)	kg (lb)
Boxed weight	≈18,8 (41,45)	kg (lb)
Power rating	140	Watt
Input voltage	100 – 240 (50 – 60)	Volt (Hz)
Protection class (electrical engineering)	II	
Production date	Shown on the rating label under «Code».	

Index

A

Accessories box extension with accessories	26
Accessories box standard with accessories.....	25
Accessories storage.....	17
Adjusting the screen brightness	57
Adjusting the sewing speed	56
Air threader circumvention.....	17, 92
Air threader connector on/off	17
Air threader nozzles.....	17
Air threader pipes chain looper	16
Air threader pipes lower looper.....	16
Air threader pipes upper looper	16

B

Background color of the sewing screen.....	58
Backing up data.....	119
Back-kick	42, 48
Bildschirm	
Cleaning	123

C

Calibrate screen.....	58, 120
Carry handle.....	19
Chain looper.....	16
Changing the needles.....	45
Changing the presser foot	44
Child safety lock	32, 60
Cleaning the looper area.....	121
clr.....	31
Cones.....	38
Connect the foot control	40
Connecting the machine.....	37
Cover.....	49
Coverstitch insert.....	17
Coverstitch needles.....	14
Coverstitch threading slot	13
Creative consultant.....	31, 32, 73
Cut-offs bin snap-in opening	13
Cutting width dial.....	13

D

Data backup.....	119
------------------	-----

Dealer data.....	117
Defective needle	65
Deleting a stitch.....	73
Differential feed.....	80
Disposing of the machine.....	126

E

eco.....	31
eco mode	32, 60
Environmental Protection.....	9
Expert mode	32
Explanation of symbols	10

F

Fabric selection	61
Factory setting	58, 118
Feed dog	14
Firmware	
Activate/deactivate functions.....	28
Navigation	27
Set values.....	28
Firmware update.....	58, 119
Foot control connection	18
Foot spools	38
Free Hand System connection	13
Freearm	13
Freearm cleaning cover	13, 121
Freearm cover.....	54
Functions	
activate/deactivate	28

G

Gather to fit.....	82
Gathering	81
Guide rails	19
Guided mode.....	32

H

Handwheel	18
Handwheel	52
Help.....	31
Home	30

Home screen.....	31
Household spools.....	38

I

Importing data.....	119
Information on the firmware version.....	58, 117

K

Knee lifter.....	43, 52
Knife.....	16
Knife cover insert.....	17, 49
Knife cover insert/Coverstitch insert.....	13
Knife on/off.....	13

L

Language selection.....	58, 116
Lifting the front foot.....	42
Lifting the presser foot up/down.....	42
Lifting the presser foot up/down with the knee lifter.....	43
Logfile.....	117
Looper cover.....	13, 17, 49
Looper thread.....	62
Lower looper.....	16

M

Moving the needles up/down.....	48
mtc micro thread control.....	84
mtc micro thread control dial.....	16

N

Navigation.....	27
Needle holder.....	14
Needle holder.....	44
Needle pad.....	17
Needle thread.....	62
Needle window.....	14
Needle, Thread and Fabric.....	61, 63
Needles, Threads.....	62

O

Overlock needles.....	14
Overlocker oil.....	123
Overlockstitch.....	66
Overwriting a stitch.....	72

P

Personal memory.....	72
Personalize the sewing screen.....	58
Power cable connection.....	18
Power switch.....	18
Press the foot control.....	41
Presser foot lifter.....	19
Presser foot presser wheel.....	19
Presser foot pressure.....	85
Presser foot release button.....	19
Presser foot shaft.....	14
Presser foot spring.....	14
Provided accessories.....	22, 24
Pulse drive.....	89

R

Renaming a stitch.....	73
Retractable thread guide.....	19, 38
Rolled hem selection lever.....	16, 83
Ruffling/Gathering.....	81

S

Saving a stitch.....	72
Screen.....	13
Securing stitches.....	107
Securing the overlock chain.....	106
Selecting the needle.....	63
Selecting the thread.....	61
Set sound.....	57
Set values.....	28
Setting the sewing light.....	57
Setting the stitch width.....	86
Setup Program.....	31
Sewing light.....	13
Sewing start.....	61
Sewing test overlock stitch.....	103
Slide-on table.....	54
Spool disc.....	39
Spool net.....	40
Spool pin.....	19
Spool stabilizer.....	39
Standard cover presser foot.....	15
Standard presser foot overlock/coverstitch.....	14

Stitch plate 14
 Stitch selection..... 71
 Storage..... 126
 Stretching 82
 Swinging the presser foot in/out 43

T

Thread cutter 13, 19, 52
 Thread deflection fingers 13
 Thread guide on the headframe 13
 Thread guide on the needle holder 14
 Thread guiding plate 13
 Thread stand..... 19, 38
 Thread take-up lever cover 13
 Thread take-up lever guide 13
 Thread tension fine adjustment..... 13
 Threader cover..... 13, 17, 49
 Threading chart 17, 87
 Threading wire 94
 Touchscreen pen..... 26
 Touchscreen pen magnetic holder..... 18
 Troubleshooting..... 124
 Tutorial..... 31
 Type label 18

U

Upper looper 16
 Upper looper converter 16
 Upper looper converter 77
 Upper looper on/off..... 17
 USB stick..... 119
 USB-Anschluss 18

W

Wallpaper of the sewing screen 58
 Waxed threads..... 62, 89
 Welcome text 58

in partnership with

Mettler[®]

BERNINA International AG | CH-8266 Steckborn Switzerland | www.bernina.com | © Copyright by BERNINA International AG

1026025.10A.04
2020-04

made to create **BERNINA**