



View this machine and more at:

<https://www.thesewingstudio.co.uk>



BERNINA 740

LOOKING FOR A NEW SEWING PROJECT?

You can find what you want in "inspiration", our sewing magazine. Thanks to great sewing patterns and detailed sewing instructions, every project succeeds right away.

Inspiration magazine
is available in German, English,
French and Dutch



* Not available in all countries.



Dear BERNINA customer

Congratulations! You have decided on BERNINA and therefore on a product which will delight you for years. For more than 100 years our family company has attached greatest importance to satisfied customers. As for me, it is a matter of personal concern to offer you Swiss development and precision at the height of perfection, future-orientated sewing technology and a comprehensive customer service.

The BERNINA 7-series consists of various ultramodern machines, whose development not only focused the highest demands on technique and the ease of use but also considered the design of the product. After all we sell our products to creative people like you, who do not only appreciate high quality but also form and design.

Enjoy the creative sewing, embroidering and quilting on your new BERNINA 740 and keep informed about the various accessories at www.bernina.com. On our homepage you will also find a lot of inspiring sewing instructions, to be downloaded for free.

Our highly trained BERNINA dealers will provide you with more information on service and maintenance offers.

I wish you lots of pleasure and many creative hours with your new BERNINA.

A handwritten signature in black ink that reads 'H. P. Ueltschi'. The signature is written in a cursive style.

H.P. Ueltschi

Owner

BERNINA International AG

CH-8266 Steckborn

Edition notice

Graphics

www.sculpt.ch

Text, Setting and Layout

BERNINA International AG

Photos

Patrice Heilmann, Winterthur

Order number

0360445.10A.04

2018-11 EN

Copyright

2018 BERNINA International AG

All rights reserved: For technical reasons and for the purpose of product improvements, changes concerning the features of the machine can be made at any time and without advance notice. The supplied accessory can vary depending on the country of delivery.



Table of Contents

IMPORTANT SAFETY INSTRUCTIONS.....	11
Important information	13
1 My BERNINA.....	14
1.1 Introduction	14
1.2 BERNINA Quality control	14
1.3 Welcome to the world of BERNINA	14
1.4 Explanation of symbols.....	15
1.5 Overview Machine	16
Overview front controls	16
Overview front	17
Overview sideways	18
Overview back.....	19
1.6 Supplied accessories.....	20
Overview accessories machine	20
Use of the power cable (only USA/Canada).....	21
Overview presser feet	22
Accessory box.....	23
1.7 Overview User Interface	24
Overview functions/visual information	24
Overview System settings	24
Overview selection menu sewing.....	25
Overview Icons	25
1.8 Needle, Thread, Fabric.....	26
Overview Needles.....	26
Example for needle description	28
Thread selection	28
Needle/thread combination	28
2 Sewing preparation.....	30
2.1 Accessory box	30
Accessory box free standing	30
Storing accessory.....	30
2.2 Connection and Switching on	31
Connecting the foot control	31
Connecting the machine	31
Attaching the knee lifter of the Free Hand System	33
Fixing the touchscreen pen	33
Switching the machine on	33
2.3 Foot control	33
Regulating the speed via the foot control	33
Raising/Lowering the needle.....	34
2.4 Spool holder	34
Swiveling spool pin.....	34
Horizontal spool pin	35
2.5 Free arm	35



2.6	Feed dog.....	36
	Adjusting the feed dog.....	36
2.7	Slide-on table.....	37
	Using the slide-on table.....	37
2.8	Presser foot.....	37
	Adjusting the presser foot position via the knee lifter of the Free Hand System.....	37
	Adjusting the presser foot position via the button «Presser foot up/down».....	37
	Changing the presser foot.....	38
	Having the presser foot displayed in the User Interface.....	38
	Adjusting the presser foot pressure.....	39
2.9	Instruction for adjusting the feed dog.....	39
2.10	Instruction how to thread the bobbin thread.....	39
2.11	Needle and stitch plate.....	39
	Changing the needle.....	39
	Selecting the needle in the User Interface.....	40
	Selecting the needle type and the needle size.....	40
	Adjusting the needle position up/down.....	41
	Adjusting the needle position left/right.....	41
	Needle stop up/down (permanent).....	41
	Changing the stitch plate.....	42
	Selecting the stitch plate in the User Interface.....	42
2.12	Threading.....	43
	Threading the upper thread.....	43
	Threading the double needle.....	45
	Threading the triple needle.....	46
	Winding the bobbin thread.....	47
	Threading the bobbin thread.....	48
3	Setup Program.....	50
3.1	Sewing settings.....	50
	Adjusting the upper thread tension.....	50
	Adjusting the maximum sewing speed.....	50
	Programming the securing stitches.....	50
	Adjusting the hovering height of the presser foot.....	50
	Programming the button «Pattern end».....	51
	Programming the button «Thread cutter».....	52
	Adjusting the presser foot position with needle stop down.....	52
	Programming the button «Quick reverse».....	53
3.2	Selecting personal settings.....	53
3.3	Monitoring functions.....	54
	Activating the upper thread indicator.....	54
3.4	Activating the audio signals.....	54



3.5	Machine settings.....	55
	Selecting a language	55
	Adjusting the brightness of the display	55
	Adjusting the sewing light	55
	Calibrating the display	56
	Back to basic settings	56
	Deleting user data	57
	Calibrating the Buttonhole foot No. 3A	57
	Updating the machine Firmware.....	58
	Recovering saved data	58
	Cleaning the thread catcher	59
	Lubricating the machine	60
	Checking the firmware version	60
	Reviewing the total number of stitches	61
	Registering details of the dealer	61
	Saving Service data.....	62
4	System settings.....	63
4.1	Calling up the Tutorial.....	63
4.2	Calling up the Creative Consultant.....	63
4.3	Calling up the Help	63
4.4	Using eco mode	63
4.5	Cancelling any alterations with «clr»	63
5	Creative sewing	64
5.1	Overview selection menu sewing.....	64
	Selecting a stitch pattern	64
5.2	BERNINA Dual Feed.....	65
	Application of the BERNINA Dual Feed.....	65
5.3	Regulating the speed	66
5.4	Adjusting the upper thread tension	66
5.5	Editing stitch patterns	67
	Changing the stitch width	67
	Changing the stitch length	68
	Correcting the balance	68
	Programming pattern repeat	69
	Mirror image of stitch patterns	69
	Editing stitch pattern length	69
	Quick reverse.....	70
	Permanent Quick reverse	70
	Backstepping.....	70



5.6	Combining stitch patterns	70
	Overview Combi mode	70
	Creating Stitch pattern combinations.....	71
	Saving a stitch pattern combination.....	71
	Loading a stitch pattern combination.....	71
	Overwriting a stitch pattern combination.....	71
	Deleting a stitch pattern combination	72
	Editing a single stitch pattern.....	72
	Deleting a single stitch pattern	73
	Adding a single stitch pattern	73
	Mirroring a stitch pattern combination	74
	Stitch pattern combination Subdivider 1	74
	Stitch pattern combination Subdivider 2	75
	Securing a stitch pattern combination.....	75
	Programming pattern repeat	75
5.7	Administering stitch patterns.....	76
	Saving settings of stitch patterns	76
	Saving stitch patterns in personal memory	76
	Overwriting stitch patterns from the personal memory	76
	Loading stitch patterns from the personal memory	77
	Deleting stitch patterns from the personal memory.....	77
	Saving stitch patterns on the BERNINA USB stick.....	77
	Uploading a stitch pattern from the BERNINA USB stick.....	77
	Deleting stitch patterns from the BERNINA USB stick	78
5.8	Securing.....	78
	Securing with the button «Pattern end»	78
	Securing via the icon «Securing»	78
5.9	Height Compensation of uneven layers	79
5.10	Sewing Corners.....	79
6	Practical stitches	81
6.1	Overview Practical stitches.....	81
6.2	Sewing straight stitch.....	83
6.3	Securing with the automatic Securing Program	84
6.4	Sewing in the zipper	84
6.5	Sewing both sides of the zipper from bottom to top	85
6.6	Sewing Triple straight stitch	86
6.7	Sewing Triple zig zag	87
6.8	Manual darning	87
6.9	Automatic darning.....	89
6.10	Reinforced darning, automatic	90
6.11	Finishing edges	91
6.12	Sewing Double overlock.....	91
6.13	Narrow edgestitching.....	92
6.14	Wide edgestitching	92
6.15	Edgestitching using the seam guide	93



6.16	Sewing hem edges.....	93
6.17	Sewing blind hems.....	94
6.18	Sewing visible hems.....	95
6.19	Sewing flat joining seams.....	95
6.20	Sewing basting stitches.....	96
7	Decorative stitches.....	97
7.1	Overview Decorative Stitches.....	97
7.2	Bobbin-Play.....	98
7.3	Sewing cross stitches.....	99
7.4	Pintucks.....	99
	Pintucks.....	99
	Overview pintucks.....	99
	Inserting the cord.....	100
	Sewing Pintucks.....	101
8	Alphabets.....	102
8.1	Overview Alphabet.....	102
8.2	Creating lettering.....	102
8.3	Altering font size.....	103
9	Buttonholes.....	104
9.1	Overview Buttonholes.....	104
9.2	Making use of the height compensation tool.....	105
9.3	Using the compensation plate.....	105
9.4	Marking buttonholes.....	106
9.5	Cord.....	107
	Using cord with the Buttonhole foot with slide No. 3A.....	107
	Using cord with the Buttonhole foot No. 3C (optional accessory).....	108
9.6	Sewing a test sample.....	109
9.7	Determining the buttonhole slit width.....	109
9.8	Determining the buttonhole length via the Buttonhole foot with slide No. 3A.....	110
9.9	Determining the buttonhole length with Buttonhole foot No. 3C (optional accessory).....	110
9.10	Sewing a buttonhole automatically.....	111
9.11	Programming the Heirloom buttonhole.....	112
9.12	Sewing the manual 7-step buttonhole with the Buttonhole foot No. 3C (optional accessory).....	112
9.13	Sewing the manual 5-step buttonhole with the Buttonhole foot No. 3C (optional accessory).....	113
9.14	Cutting the buttonhole open with the seam ripper.....	114
9.15	Cutting open buttonholes with the buttonhole cutter (optional accessory).....	114
9.16	Sewing on buttons.....	115
9.17	Sewing eyelets.....	116



10 Quilting	117
10.1 Overview Quilt Stitches	117
10.2 Quilting, Securing Program	118
10.3 Sewing handlook quilt stitches	119
10.4 Guiding the quilt work freely.....	119
11 BERNINA Stitch Regulator (BSR)	121
11.1 BSR mode 1	121
11.2 BSR mode 2	121
11.3 BSR function with Straight stitch No. 1	121
11.4 BSR function with Zig zag No. 2	121
11.5 Sewing preparations for quilting	121
Attach the BSR presser foot	121
Changing the presser foot sole	122
11.6 Using the BSR mode.....	122
11.7 Securing.....	123
Securing in BSR1 mode with the button «Start/Stop»	123
Securing in BSR2 mode.....	124
12 Attachment	125
12.1 Maintenance and cleaning.....	125
Cleaning the display	125
Cleaning the feed dog.....	125
Cleaning the hook	125
Lubricating the hook	126
12.2 Troubleshooting.....	128
12.3 Error messages.....	131
12.4 Storage and disposal	134
Storing the machine	134
Dispose of the machine	134
12.5 Technical data.....	134
13 Overview stitch patterns	135
13.1 Overview Stitch patterns	135
Practical stitches	135
Buttonholes.....	135
Decorative stitches.....	135
Index.....	138



IMPORTANT SAFETY INSTRUCTIONS

Please be aware of the following basic safety instructions when using your machine. Before using this machine, read instruction manual carefully.

DANGER!

To reduce the risk of electrical shock:

- Never leave the machine unattended as long as it is plugged in.
- Always unplug the machine from the electrical outlet immediately after using.

Protection against LED radiation:

- Do not view the LED light directly with optical instruments (e.g. magnifier). The LED light corresponds with protection class 1M.
- When the LED light is damaged or defective, contact your BERNINA specialist dealer.

WARNING

To reduce the risk of burns, fire, electric shock or injury to persons:

- To operate the machine always use the supplied power cable. USA and Canada only: Do not connect power plug NEMA 1-15 to circuits exceeding 150 volt-to-ground.
- Use this machine only for purposes as described in this manual.
- Only use the machine in dry rooms.
- Do not use the machine in a damp condition or in a damp environment.
- Do not use this machine as a toy. Close attention is necessary when this machine is used by or near children.
- The machine can be used by children older than 8 or by people with reduced physical, sensory or mental capabilities or if there is a lack of experience and knowledge how to operate the machine as long as they are supervised or have been given instruction concerning the responsible use of the appliance and are aware of the involved risks.
- Children are not allowed to play with this machine.
- Cleaning and maintenance work must not be carried out by children unless they are supervised.
- Never operate this machine if it has a damaged cord or plug, if it is not working properly, if it has been dropped or damaged, or dropped into water. Contact the nearest authorized BERNINA dealer to arrange further details.

- Only use accessory recommended by the manufacturer.
- Don't use this machine when the ventilation openings are blocked. Keep the ventilation openings and the foot control free from the accumulation of lint, dust and loose cloth.
- Never insert any objects into any openings of the machine.
- Do not place any objects on the foot control.
- Always use the machine with a foot control of this type LV-1.
- Do not operate the machine where aerosol products (sprays) or oxygen are being used.
- Keep fingers away from all moving parts. Special care is required around the needle.
- Neither pull nor push the fabric while sewing. This can cause needle breakage.
- When making any adjustments in the needle area – such as such as threading the needle, changing the needle, threading the hook or changing the presser foot – turn power switch to «0».
- Do not use bent needles.
- Always use the original BERNINA stitch plate. The wrong stitch plate can cause needle breakage.
- To disconnect, turn power switch to «0» and then remove the plug from the outlet. Do not unplug by pulling the cord, instead grasp the plug to pull it from the outlet.
- Always disconnect the power plug from the electrical outlet when the covers are removed or opened, when the machine is lubricated or during any other maintenance adjustments mentioned in the instruction manual.
- This machine is provided with double insulation (except USA, Canada and Japan). Use only identical replacement parts. See instructions for Servicing of double-insulated products.
- The sound pressure level is lower than 70 dB(A) under normal conditions.



Important information

Availability of the instruction manual

The instruction manual is supplied with the machine.

- Keep the instruction manual safe at a suitable place near the machine to have it at hand in case that you need to look up something.
- If you pass the machine to a third party, always include the instruction manual.

Appropriate use

Your BERNINA machine is conceived and designed for private household use. It answers the purpose to quilt fabrics as it is described in this instruction manual. Any other use is not considered appropriate. BERNINA assumes no liability concerning consequences resulting from an inappropriate usage.

Servicing of double-insulated products

In a double-insulated product two systems of insulation are provided instead of grounding. No grounding means is provided on a doubleinsulated product, nor should a means for grounding be added to the product. Servicing a double-insulated product requires extreme care and knowledge of the system and should be done only by qualified service personnel. Replacement parts for a double-insulated product must be identical to the original parts in the product. A double-insulated product is marked with the words: «Double insulation» or «double-insulated».

 The symbol may also be marked on the product.

Environmental Protection

BERNINA is committed to the protection of the environment. We strive to minimize the environmental impact of our products by continuously improving product design and our technology of manufacturing.



The machine is labeled with the symbol of the crossed-out wastebin. This means that the machine must not be disposed of with the household waste when the machine is no longer needed. Improper disposal can result in dangerous substances getting into the groundwater and thus into our food chain, damaging our health.

The machine must be returned free of charge to a nearby collection point for waste electrical and electronic equipment or to a collection point for the reuse of the machine. Information on the collection points can be obtained from your local administration. When purchasing a new machine, the dealer is obliged to take back the old machine free of charge and dispose of it properly.

If the machine contains personal data, you are responsible for deleting the data yourself before returning the machine.

1 My BERNINA

1.1 Introduction

With your BERNINA 740 you can sew, embroider and quilt. Delicate silk or satin fabrics as well as heavy-weight linen, fleece and denim can be sewn without any problems with this machine. Numerous practical as well as decorative stitches, buttonholes and embroidery motifs are at your disposal.

Additional to this instruction manual, following help programs are provided, giving you useful advice and support at any time how to operate you BERNINA 740.

The **Tutorial** provides information and explanations on different sections concerning sewing and the various stitches.

The **Creative Consultant** informs you about decision support for sewing projects. After entering the kind of fabric and the desired sewing project, suggestions concerning the suitable needle or the appropriate presser foot are displayed.

The **Help Program** provides information about individual stitch patterns, functions and operations in the display.

Further information

In addition to this instruction manual of your BERNINA 740 further information products are enclosed.

The latest version of your instruction manual as well as additional information in connection with the machine and accessories can be found on our website <http://www.bernina.com>

1.2 BERNINA Quality control

All BERNINA machines are assembled with utmost care and are subjected to an extensive functionality test. The integrated stitch counter therefore indicates that the machine has already sewn stitches, which were performed exclusively for test purposes and quality control. The subsequent thorough cleaning does not exclude the possibility that thread remnants may still be found in the machine.

1.3 Welcome to the world of BERNINA

«Made to create», is BERNINA's slogan. Not only our machines do support you to implement your ideas. On top of that, our below mentioned opportunities also offer various inspirations and instructions for your future projects as well as the option to exchange ideas with other sewing and embroidering enthusiasts. We wish you lots of pleasrue doing that.

BERNINA YouTube Channel

On YouTube we offer a wide range of how-to videos and support concerning the most important functions of our machines. Detailed explanations are also provided as for the various presser feet, so that your projects will succeed completely.

<http://www.youtube.com/BerninaInternational>

Provided in the languages English and German.

inspiration – the sewing magazine

Are you looking for ideas, sewing patterns and instructions for great projects? In that case the BERNINA magazine «inspiration» is exactly what you need. «inspiration» offers extraordinary sewing and embroidery ideas four times a year. From seasonal fashion trends to trendy accessories and practical tips to decorate your home in an original way.

<http://www.bernina.com/inspiration>

The magazine is available in the languages English, German, Dutch and French. Not available in all countries.

BERNINA Blog

Fancy instructions, free sewing patterns and embroidery motifs as well as many new ideas: all this you can find in the weekly blog by BERNINA. Our experts give valuable tips and explain step by step how you can achieve the desired result. In the community you can upload your own projects and exchange experiences and ideas with other sewing and embroidering enthusiasts.

<http://www.bernina.com/blog>

Provided in the languages English, German and Dutch.

BERNINA Social Media

Follow us on the social networking to learn more about events, thrilling projects as well as tips and tricks all about sewing and embroidering. We will keep you informed and we are looking forward to presenting you the one or the other highlight from the world of BERNINA.

<http://www.bernina.com/social-media>

1.4 Explanation of symbols



DANGER

Labels a danger with a high risk which can lead to death or severe injury unless it is avoided.



WARNING

Labels a danger with a medium risk which can lead to death or severe injury unless it is avoided.



CAUTION

Designates a hazard with low risk that can cause minor or moderate injury if not avoided.

NOTICE

Designates a hazard that can cause property damage if not avoided.



Tips given by BERNINA **sewing experts** can be found next to this symbol.

By means of illustration, sample pictures are used in this instruction manual. The machines and accessories shown in the pictures do not necessarily correspond to the actual items delivered with your machine.

1.5 Overview Machine

Overview front controls



- | | | | |
|---|----------------------|---|----------------------------|
| 1 | Quick reverse | 6 | Needle up/down |
| 2 | Thread cutter | 7 | Upper Multifunctional knob |
| 3 | Presser foot up/down | 8 | Lower Multifunctional knob |
| 4 | Start/Stop | 9 | Needle left/right |
| 5 | Pattern end | | |

Overview front



- | | | | |
|---|---|----|-----------------------------------|
| 1 | Bobbin cover | 7 | Thread take-up lever cover |
| 2 | Connection for accessory (optional accessory) | 8 | Thread take-up lever |
| 3 | Presser foot | 9 | Fixing screw |
| 4 | Needle threader | 10 | Connection for the slide-on table |
| 5 | Sewing light | 11 | Connection for Free Hand System |
| 6 | Speed control | | |

Overview sideways



- | | | | |
|---|---------------------------------|----|-----------------------------------|
| 1 | Connection for foot control | 7 | Power switch |
| 2 | PC-connection | 8 | Connection for power cable |
| 3 | Spool pin | 9 | Magnet holder for touchscreen pen |
| 4 | Winding unit with thread cutter | 10 | Air vents |
| 5 | Swiveling spool pin | 11 | USB port |
| 6 | Handwheel | 12 | Feed dog up/down |

Overview back



1	Connection for the slide-on table	9	Thread pretension
2	Connection for darning hoop	10	Thread guide
3	BSR connection	11	Fixing screw
4	Connection for accessory (optional accessory)	12	BERNINA Dual Feed
5	Air vents	13	Thread cutter
6	Thread guide	14	Feed dog
7	Bobbin winding unit	15	Stitch plate
8	Carrying handle		

1.6 Supplied accessories

Overview accessories machine

All rights reserved: For technical reasons and for the purpose of product improvements, changes concerning the features of the machine can be made at any time and without advance notice. The supplied accessory can vary depending on the country of delivery.

Please visit www.bernina.com for more accessory information.



















Illustration	Name	Purpose
	Soft Cover with pocket	To protect the machine from dust and contamination.
	Accessory box	To store the supplied accessories as well as the optional accessories.
	Free Hand System (FHS)	To raise and lower the presser foot.
	Slide-on table	To increase the sewing surface.
	Spool disc	To support the regular unwinding of the thread from the spool. 3 different sizes for thread spools in different sizes.
	Bobbin 4 pieces, 1 of them in the machine	To wind the bobbin thread.
	Foam pad 2 pieces	To prevent the thread from slipping under the spool holder, tangling and breaking.
	Touchscreen pen	For precise operation of the touch display.









Illustration	Name	Purpose
	Seam ripper	To undo seams and to cut buttonholes open.
	Height compensating tool	To level an angled position of the presser foot sole when sliding over thick seams.
	Selection of needles	For any common applications.
	Seam guide, right	To align regular seam distances.
	Screwdriver Torx, gray	To change the needle.
	Screwdriver red (slot)	To loosen and tighten slotted screws.
	Angular Torx wrench Torx	To open the headframe.
	Brush	to clean the feed dog and the hook race area.
	Oil pen	To fill up the oil depots.
	Power cable	To connect the machine with the power supply system.
	Foot control	To start and stop the machine. To control the sewing speed.

Use of the power cable (only USA/Canada)

The machine has a polarized plug (one blade wider than the other). To reduce the risk of electrical shock, this plug is intended to fit in a polarized outlet only one way. If the plug does not fit fully in the outlet, reverse the plug. If it still does not fit, contact a qualified electrician to install the proper outlet. Do not modify the plug in any way!

Overview presser feet

Supplied standard presser feet

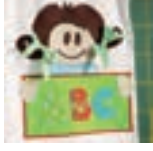
Illustration	Number	Name	Purpose	Example
	# 1C	Reverse pattern foot	To sew various practical and decorative stitches. To sew forward and in reverse.	
	# 1D	Reverse pattern foot	To sew various practical and decorative stitches with Dual Feed. To sew forward and in reverse.	
	# 3A	Automatic Buttonhole foot with slide	To sew buttonholes automatically.	
	# 4D	Zipper foot	To sew in zippers with Dual Feed.	
	# 20C	Open embroidery foot	To sew appliqués and decorative patterns.	

Accessory box

All rights reserved: For technical reasons and for the purpose of product improvements, changes concerning the features of the machine can be made at any time and without advance notice. The supplied accessory can vary depending on the country of delivery.

The illustrated accessory (kind and quantity) serves as an example and doesn't have to correspond with the supplied accessory.

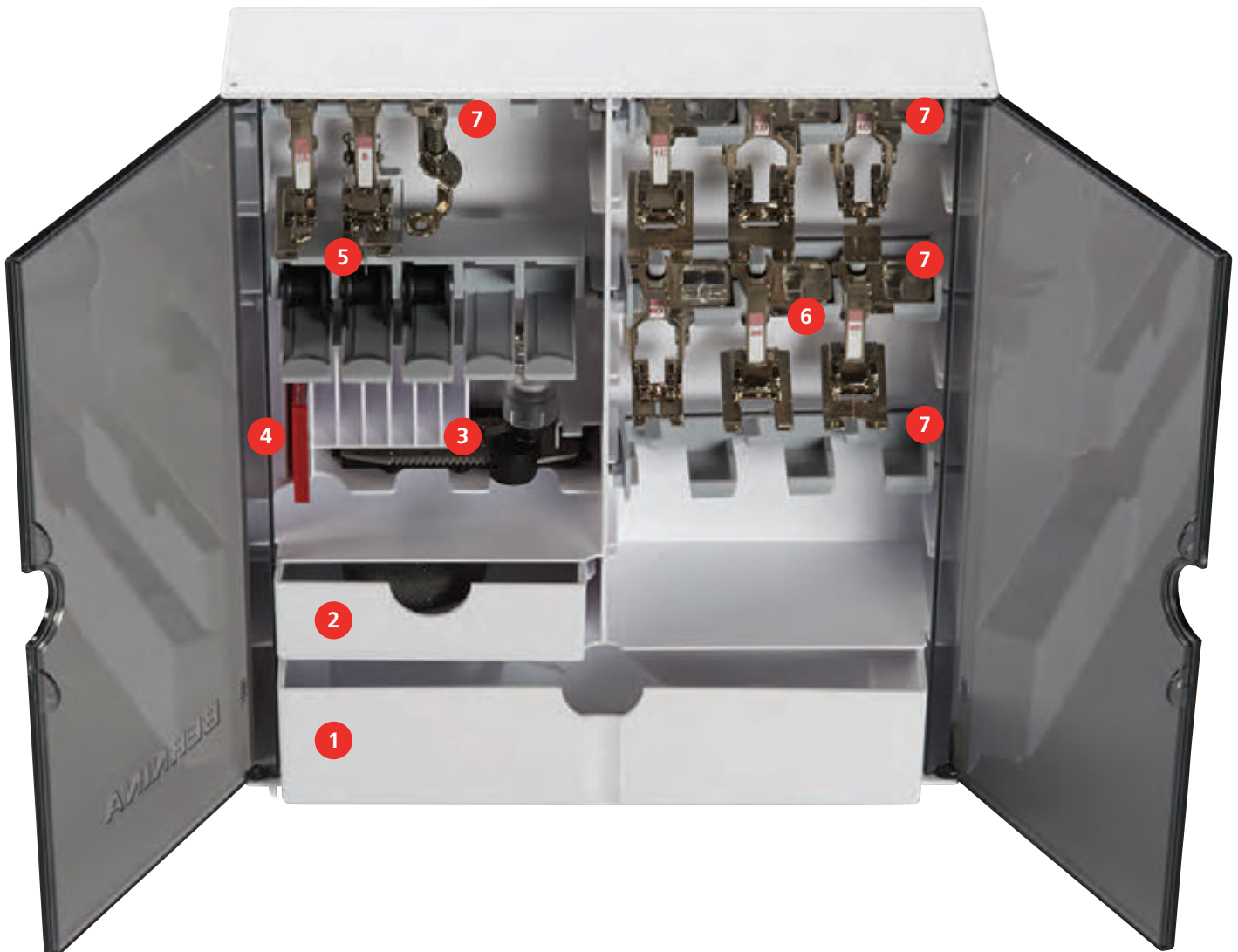

- | | | | |
|---|--------------------------------------|---|---|
| 1 | Big drawer | 5 | Spool holder |
| 2 | Small drawer | 6 | Presser feet |
| 3 | Automatic Buttonhole foot with slide | 7 | Presser foot holders for 5.5 mm and 9.0 mm feet |
| 4 | Selection of needles | | |

1.7 Overview User Interface

Overview functions/visual information



- | | | | |
|---|------------------------|---|---|
| 1 | Upper thread tension | 4 | Stitch plate/Needle selection |
| 2 | Presser foot indicator | 5 | Feed dog up/down |
| 3 | Presser foot pressure | 6 | Instruction how to thread the bobbin thread |

Overview System settings



- | | | | |
|---|---------------------|---|-------------------------|
| 1 | Home | 5 | Help |
| 2 | Setup Program | 6 | eco mode |
| 3 | Tutorial | 7 | Back to default setting |
| 4 | Creative Consultant | | |



Overview selection menu sewing



- | | | | |
|---|---------------------|---|-----------------|
| 1 | Practical stitches | 4 | Buttonholes |
| 2 | Decorative stitches | 5 | Quilt stitches |
| 3 | Alphabets | 6 | Personal Memory |

Overview Icons

Icon	Name	Purpose
	i-Dialog	Touching the icon «i»-Dialog provides various functions to edit motifs.
	Close	The display is closed and the previously made adjustments are saved.
 	Icons «-/+»	By touching the icons «-» and «+» the setting values are changed.
	Yellow frame around the icon	A yellow-framed icon indicates that a setting or a value in this function has been changed. By touching the yellow-framed icon, the default setting can be restored.
	Confirm	Confirms the previously adjusted alterations. The display is closed.
	Cancel	The process is canceled. The display is closed and the previously made adjustments are not saved.

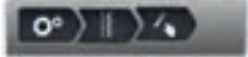
Icon	Name	Purpose
	Slide	By moving the slide the setting values are changed.
	Switch	Activates or deactivates functions.
	Process navigation	With the process navigation scrolling back in the display is possible.
	Swipe function	By swiping the display using the touchscreen pen or the finger upwards or downwards, further functions can be displayed.

1.8 Needle, Thread, Fabric

In the course of time a needle wears out. Therefore it should be replaced regularly. Only a perfect point results in a good stitching result. In general it can be said: the thinner the thread, the finer the needle. The illustrated needles are either standard or optional accessory, depending on the machine.

- Needle sizes 70, 75: for thin fabrics.
- Needle sizes 80, 90: for medium fabrics.
- Needle sizes 100, 110 and 120: for heavy fabrics.

Overview Needles

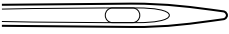

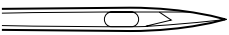
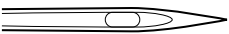



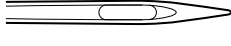
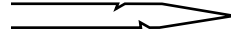



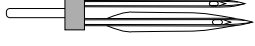

Illustration	Needle name	Needle description	Purpose
 ☒	Universal needle 130/705 H 60-120	Slightly rounded point	For nearly all natural and synthetic fabrics (woven and knitted).
 ■	Stretch needle 130/705 H-S 75, 90	Mid-sized ball point, special eye shape and needle scarf	For jersey, tricot, knit and stretch fabrics.
 ■	Jersey/Embroidery needle 130/705 H SUK 60-100	Mid-sized ball point	For knitware, knitted good. For embroidering.
 ■	Jeans needle 130/705 H-J 80-110	Point, narrow point, reinforced shaft	For heavy-weight fabrics such as jeans or canvas.
 ■	Leather needle 130/705 H LR 90, 100	With cutting point (LR = special point to sew leather)	For all types of leather, synthetic leather, plastic, sheeting.
 ■	Microtex needle 130/705 H-M 60-110	Especially sharp, narrow point	For micro fiber fabrics and silk.

Illustration	Needle name	Needle description	Purpose
 ■	Quilting needle 130/705 H-Q 75, 90	Slightly rounded fine point	For straight and topstitching.
 ■	Embroidery needle 130/705 H-E 75, 90	Small ball point, especially wide needle eye and wide thread groove	For embroidery on all natural and synthetic fabrics.
 ☒	Fine-material needle 130/705 H SES 70, 90	Small ball point	For fine knitware and knitted materials. For embroidery on fine, delicate fabrics.
 ■	Metafil needle 130/705 H METAFIL 80	Long needle eye (2 mm) in all needle sizes	For sewing or embroidering with metallic threads.
 ■	Cordonnet needle (to patch embroidery) 130/705 H-N 70-100	Long needle eye (2 mm) in all needle sizes	Topstitching with thick thread.
	Felt needle PUNCH	Needle with barbed hook	For felt work.
 ☒	Hemstitch needle 130/705 H WING 100-120	Wing-like widened needle shaft (wing)	To sew blind stitches.
 ☒	Universal double needle 130/705 H ZWI 70-100	Needle distance: 1.0/1.6/2.0/2.5/3.0/4.0/6.0/8.0	For visible hems in stretch fabrics, pintucks, decorative sewing.
 ☒	Stretch double needle 130/705 H-S ZWI 75	Needle distance: 2.5/4.0	For visible hems in stretch fabrics, pintucks, decorative sewing.
 ☒	Hemstitch double needle 130/705 H ZWIHO 100	Needle distance: 2.5	For special effects with hemstitch embroidery.
 ☒	Universal triple needle 130/705 H DRI 80	Needle distance: 3.0	For visible hems in stretch fabrics, decorative sewing.

Example for needle description

The 130/705 system, which is the most common for household machines, is explained by the following picture of a Jersey/Stretch needle.

	<p>130/705 H-S/70</p> <p>130 = Shank length (1)</p> <p>705 = Flat shank (2)</p> <p>H = Needle scarf (3)</p> <p>S = Needle point (here medium ball point) (4)</p> <p>70 = Needle size 0.7 mm (5)</p>
---	---

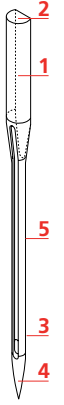
Thread selection

For a perfect sewing result, thread and fabric quality play an important role.

We recommend purchasing quality threads to achieve good sewing results.

- Cotton threads have the advantage of being a natural fiber and therefore are especially suitable for sewing cotton fabrics.
- Mercerized cotton threads have a slight sheen that is not lost with washing.
- Polyester threads have a high tensile strength and is particularly colorfast.
- Polyester threads are more flexible and are recommended where a strong and elastic seam is required.
- Rayon threads are made of natural fibers and have a brilliant sheen.
- Rayon threads are suitable for decorative stitches and achieve a more beautiful effect.

Needle/thread combination

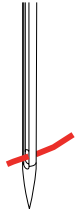
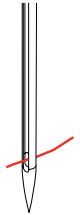
	<p>The needle/thread combination is correct, when the thread fits perfectly into the long groove and goes easily through the needle eye. The thread can be optimally secured.</p>
	<p>The thread can break and skipped stitches can occur when there is too much clearance in the long groove and the needle eye.</p>

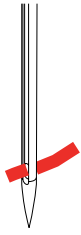

The thread can break and get stuck when the thread scrapes against the edge of the long groove not fit well into the needle eye optimally.

2 Sewing preparation

2.1 Accessory box

Accessory box free standing

- > On the back of the box, pull both extensions out until they click into place.



Storing accessory

NOTICE

Incorrect sorting of the bobbin

The silvery sensor surface can get scratched.

- > Make sure that the silvery sensor surfaces are on the right side when sorting the bobbins into the accessory box.

- > Insert the holders (1) for bobbins, feet and needles.
- > Store the small parts, e.g. thread discs etc., in the drawers (2) and (3).
- > Store the Buttonhole foot with slide No. 3A in compartment (4).
- > Store the provided needle package in the special compartment (5).
- > Insert the bobbins into the compartment (6) of the accessory box so that the silvery sensor surfaces are on the right side.
- > To remove a bobbin, press the compartment holder down.
- > Store the presser feet in the holders (7) (5.5 mm or 9.0 mm).

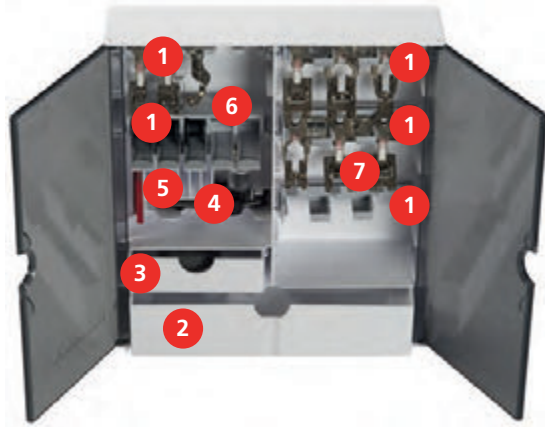

2.2 Connection and Switching on

Connecting the foot control

> Unwind the cable of the foot control to the desired length.



> Insert the cable of the foot control into the foot control connection.



Connecting the machine

> Insert the power cable into the power cord connection.





Sewing preparation

- > Insert the power cable into the power cord connection.



Attaching the knee lifter of the Free Hand System



The lateral position of the knee lifter can be adjusted by your local BERNINA Dealer if required.

- > Insert the knee lifter into the opening at the front side of the machine.
- > Adjust the sitting height so that the knee lifter can be operated with the knee.

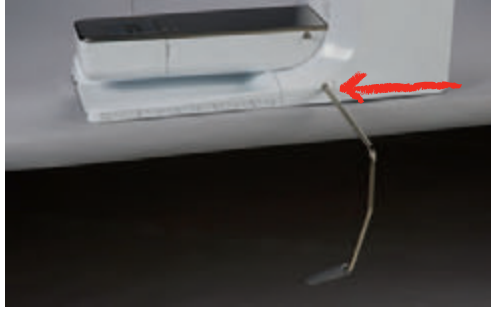

Fixing the touchscreen pen

- > Store the touchscreen pen at the magnet holder.



Switching the machine on

- > Switch on the machine at the main switch to «I».



2.3 Foot control

Regulating the speed via the foot control

Via the foot control the speed is infinitely variable.

- > Press the foot control down carefully to start the machine.
- > To sew faster, press the foot control harder.

- > Release the foot control to stop the machine.



Raising/Lowering the needle

- > Sink the heel back on the foot control to raise/lower the needle.



2.4 Spool holder

Swiveling spool pin

Installing the spool holder



With metallic or other special threads, it is recommend to use the swiveling spool pin.

The swiveling spool holder is necessary when several threads are sewn and it can also be used for bobbin winding while sewing.

- > Swivel the spool holder up as far as it will go.



Inserting foam pad and thread spool

The foam pad prevents the thread from getting hooked at the swiveling spool holder.



- > Place the foam pad on the swiveling spool holder.
- > Place the thread spool on the spool holder.



Horizontal spool pin

Placing the foam pad, the thread spool and the spool disc

The spool disc provides an even unwinding of the thread from the thread spool. The spool disc is only used with the horizontal spool pin.

- > Place the foam pad on the spool pin.
- > Place the thread spool on the spool pin.
- > Position the appropriate spool disc on the spool pin so that there is no space between the spool disc and the thread spool.



Using a spool net

The spool net provides an even unwinding of the thread from the thread spool and prevents the thread from knotting and breaking. The spool net is only used with the horizontal spool holder.

- > Pull the spool net over the thread spool.



2.5 Free arm

The BERNINA 740 provides a solidly designed free arm which offers a lot of space for large project on the right of the needle.



2.6 Feed dog

Adjusting the feed dog

NOTICE

Inappropriate handling of the fabric

Damage of the needle and the stitch plate.

> Let the sewing project be fed evenly.

With each stitch, the feed dog moves forward by one step. The length of this step is determined by the stitch length selected.

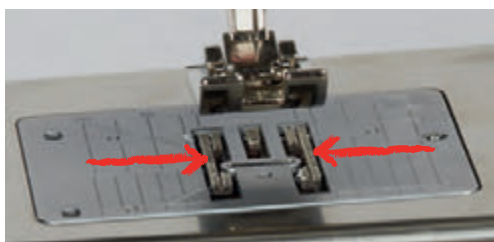

With a short stitch length, the steps are very short. For example when sewing buttonholes and satin stitches. The fabric is fed slowly under the presser foot, even when sewing at maximal speed.

	<p>Let the fabric be fed evenly; this results in a more perfect stitch formation.</p>
	<p>Pulling or pushing the fabric will result in uneven stitches.</p>
	<p>Holding back the fabric will result in uneven stitches.</p>

> Push the button «Feed dog up/down» to lower the feed dog.



> Push the button again to sew with the feed dog up.

2.7 Slide-on table

Using the slide-on table

When attached to the free arm, it expands the already existing sewing area.

- > Raise the needle.
- > Raise the presser foot.
- > Switch the machine off and disconnect it from the power supply system.
- > Push the slide-on table to the right over the free arm until it engages.



- > To remove the slide-on table, press the button at the table down and pull the slide-on table over the free arm to the left.



2.8 Presser foot

Adjusting the presser foot position via the knee lifter of the Free Hand System

- > Adjust the sitting height so that the knee lifter can be operated with the knee.
- > Push the knee lifter with the knee to the right to raise the presser foot.

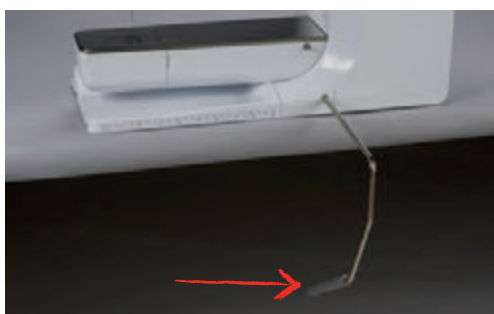

- Simultaneously the feed dog is lowered and the thread tension is released.
- > Release the knee lifter slowly to lower the presser foot.

Adjusting the presser foot position via the button «Presser foot up/down»

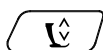

- > Push the button «Presser foot up/down» to raise the presser foot.
- > Push the button «Presser foot up/down» again to lower the presser foot.

Changing the presser foot

- > Raise the needle.
- > Raise the presser foot.
- > Switch the machine off and disconnect it from the power supply system.
- > Push the clamping lever up.



- > Remove the presser foot.
- > Guide the new presser foot upwards over the cone.
- > Press the clamping lever down.

Having the presser foot displayed in the User Interface

The recommended presser foot for the selected stitch is displayed. In addition to that, optional presser feet can be displayed.

- > Switch the machine on.
- > Select a stitch pattern.
 - In the icon «Presser foot display» the recommended presser foot is indicated with a number.



- > Touch the icon «Presser foot display».
- > With the touchscreen pen/finger scroll up within the range of presser feet to have optional presser feet displayed.
- > If a presser foot is touched, the description and the application for this presser foot is displayed.

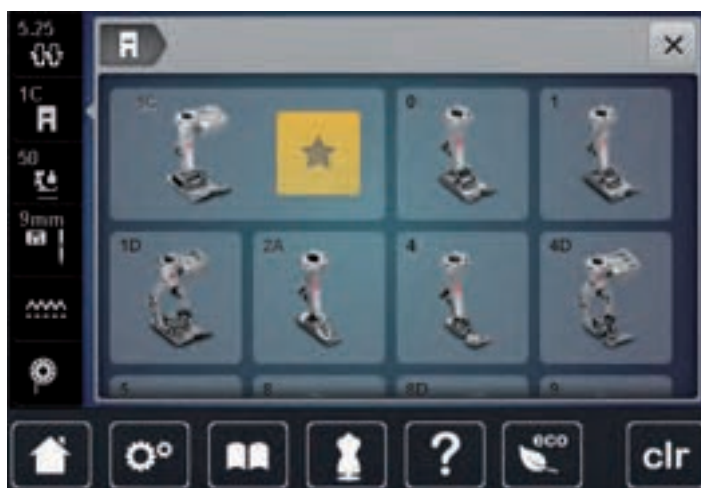

Adjusting the presser foot pressure



The presser foot pressure is designed to adjust the pressure of the presser foot optimally to the fabric thickness. When working with thick fabrics, it is recommended to reduce the presser foot pressure. This provides the advantage that the presser foot is slightly lifted so that the fabric can be moved more easily. When working with thin fabrics, it is recommended to increase the presser foot pressure. This provides the advantage that the fabric cannot be moved too easily under the presser foot.



- > Touch the icon «Presser foot pressure».
- > Move the slide with the touchscreen pen/finger to adjust the presser foot pressure.

2.9 Instruction for adjusting the feed dog



- > Touch the icon «Feed dog up/down».
- > Raise or lower the feed dog according to the animation.

2.10 Instruction how to thread the bobbin thread



- > Touch the icon «Bobbin thread».
- > Thread the bobbin thread according to the animation.

2.11 Needle and stitch plate

Changing the needle

- > Raise the needle.
- > Switch the machine off and disconnect it from the power supply system.
- > Remove the presser foot.
- > Loosen the fixing screw of the needle using the screwdriver gray Torx.



- > Pull the needle down.
- > Hold the new needle with the flat side to the back.
- > Insert the needle as far as it will go.
- > Tighten the fixing screw of the needle using the screwdriver gray Torx.

Selecting the needle in the User Interface

After having changed the needle, it can be checked whether or not it can be used in combination with the selected stitch plate.



> Touch the icon «Stitch plate/Needle selection».



> Select the inserted needle.

Selecting the needle type and the needle size

Convenient memory function: To prevent a loss of information, the needle type and the needle size can be saved additionally on the machine. The saved needle type and the saved needle size can be checked at any time.



> Touch the icon «Stitch plate/Needle selection».

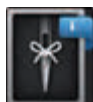

> Touch the icon «Needle type/Needle size».
 > Select the needle type (1) of the inserted needle.
 > Select the needle size (2) of the inserted needle.



Adjusting the needle position up/down



- > Push the button «Needle up/down» to lower the needle.
- > Push the button «Needle up/down» again to raise the needle.

Adjusting the needle position left/right

There is a total of 11 needle positions. The needle position is indicated by the needle position number in the display.

- > Push the button «Needle left» (1) to move the needle to the left.
- > Push the button «Needle right» (2) to move the needle to the right.

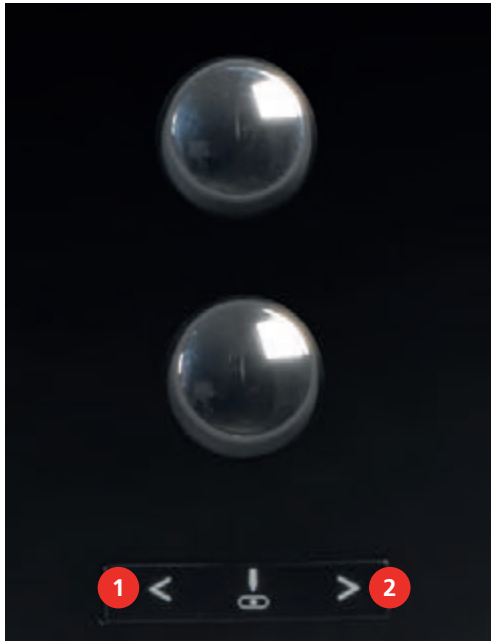

Needle stop up/down (permanent)



- > Touch the icon «Needle stop up/down (permanent)» to fix the needle position permanently.
 - The machine stops with needle position down as soon as the foot control is released or the button «Start/Stop» has been pressed.
- > Touch the icon «Needle stop up/down (permanent)» again.
 - The machine stops with needle position up as soon as the foot control is released or the button «Start/Stop» has been pressed.

Changing the stitch plate

The stitch plate is marked with vertical, horizontal and diagonal lines in millimeters (mm) and inches (inch). These lines help to guide the fabric when sewing seams and precise topstitching.

Prerequisite:

- The feed dog is lowered.
 - The machine is switched off and disconnected from the power supply system.
 - Needle and presser foot are removed.
- > Press the stitch plate down at the mark back right until it flips up.



- > Remove the stitch plate.
- > Place the openings of the new stitch plate above the corresponding guide pins and press down until it clicks into place.

Selecting the stitch plate in the User Interface

After having changed the stitch plate, it can be checked whether or not it is suitable to be used in combination with the selected needle.



- > Touch the icon «Stitch plate/Needle selection».
- > Select the previously attached the stitch plate.



- If the selected stitch plate is suitable in combination with the needle, sewing can be started.
- If the selected stitch plate is not suitable in combination with the needle, starting the machine is automatically blocked.

2.12 Threading

Threading the upper thread

Prerequisite:

- The needle and the presser foot are raised.
 - The machine is switched off and disconnected from the power supply system.
- > Place the foam pad on the spool holder.
 - > Place the thread spool on the spool holder so that the thread unwinds clockwise.
 - > Add the appropriate spool disc.
 - > Guide the thread in direction of the arrow through the rear thread guide (1) and hold the thread with the hands so that it is taut and can be inserted into the thread tension.
 - > Guide the thread in direction of the arrow through the thread tension (2).



- > Guide the thread downwards (3) around the thread take-up lever cover (4).
- > Guide the thread upwards and insert into the thread take-up lever (5).
- > Guide the thread downwards again (6).



- > Guide the thread through the guides (7/8) above the presser foot.

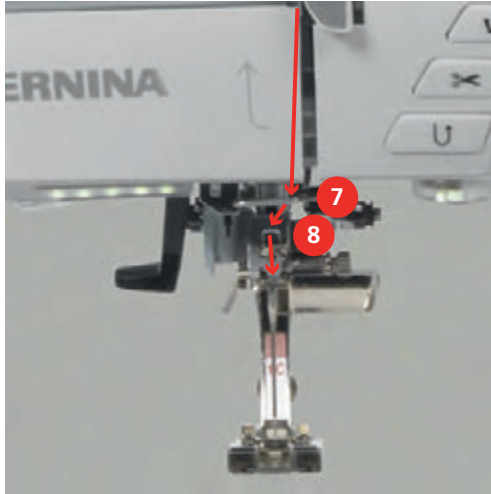

- > Switch the machine on.
- > Press the semi-automatic threader lever (9) slightly down, keep pressed and pull the thread to the left beneath the gray threader hook (10).



- > Guide the thread around the gray threader hook from the left to the right (12).
- > Press the threader lever down as far as it will go (11) and then pull the thread from the left to the right (12) through the threader slot (13) until it hooks into the small wire hook.

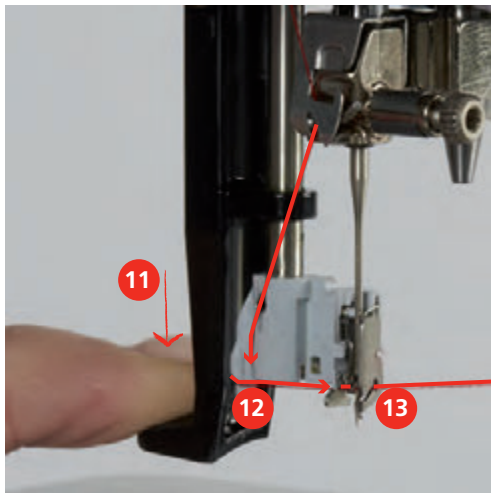

- > Release the lever and the thread simultaneously to thread.
- > Pull the thread loop (14) to the back.

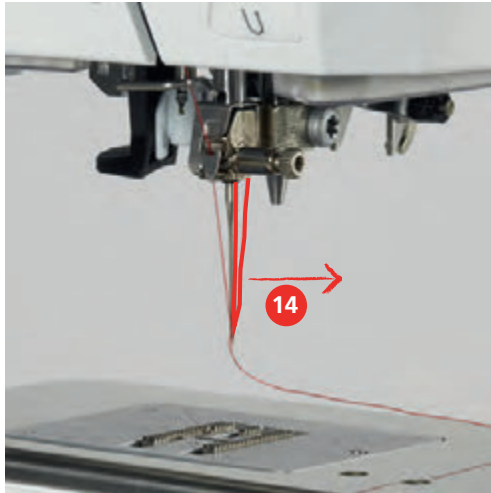

- > Pull the thread beneath the presser foot from back to front over the thread cutter (15) and cut.



Threading the double needle

Prerequisite:

- The double needle is inserted.
- > Guide the first thread in direction of the arrow on the right side of the tension disc (1).
- > Guide the second thread in direction of the arrow on the left side of the tension disc (1).

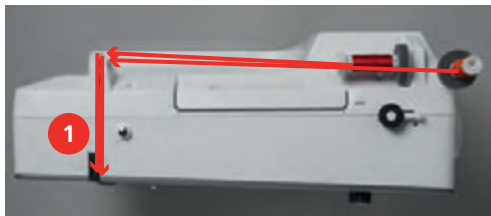

- > Guide the first and the second thread to the thread guide above the needle.
- > Thread the first thread manually into the right needle.

- > Thread the second thread manually into the left needle.

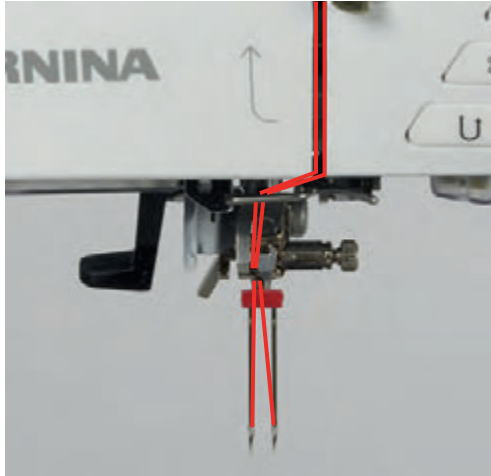

Threading the triple needle

Always attach a foam pad when using the swiveling spool holder. This prevents the thread from getting hooked at the spool holder.

Prerequisite:

- The triple needle is inserted.
- > Place the foam pad, the thread spool and the appropriate spool disc on the spool holder.
- > Place the filled bobbin on the swiveling spool holder.
- > Add the appropriate spool disc.
- > Place the thread spool.
- > Thread the 3 threads up to the upper thread guide.

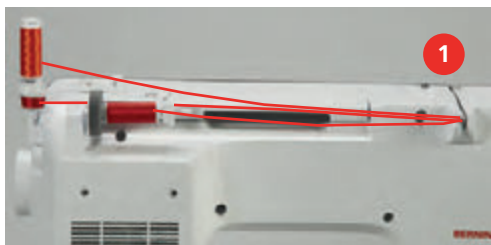

- > Guide 2 threads past the thread tension discs (1) on the left and to the thread guide above the needle.
- > Guide 1 thread past the thread tension discs (1) on the right and to the thread guide above the needle.
- > Thread the first thread into the left needle manually.
- > Thread the second thread into the center needle manually.
- > Thread the third thread into the right needle manually (see page 45).



Winding the bobbin thread

Prerequisite:

- The foam pad, the thread spool and the appropriate spool disc are positioned.
- > Attach the empty bobbin on the winding unit (1) so that the silvery sensor surface is down.



- > Guide the thread to the left into the rear thread guide (2).
- > Guide the thread around the thread pretension clockwise (3).
- > Wind the thread clockwise 2 to 3 times around the empty bobbin (4).

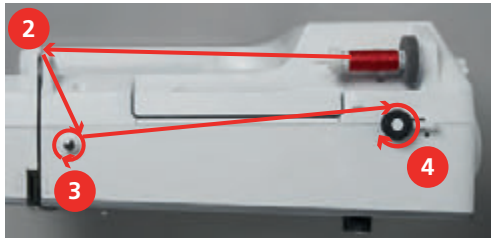

- > Pull the excess thread over the thread cutter at the engaging lever (5) and cut.



- > Push the engaging lever (6) towards the bobbin.



- The machine winds and the display to wind the bobbin appears.
- > Move the slide on the display using the touchscreen pen or the finger to adjust the winding speed.
- > To stop the winding process, the engaging lever must be pressed to the right.
- > Push the engaging lever towards the bobbin again to continue the winding process.
 - As soon as the bobbin is full, the machine stops the winding process automatically.
- > Remove the bobbin and cut the thread using the thread cutter at the engaging lever.

Threading the bobbin thread

Prerequisite:

- The needle is raised.
 - The machine is switched off and the bobbin cover is opened.
- > Press the bobbin case release at the bobbin case (1).

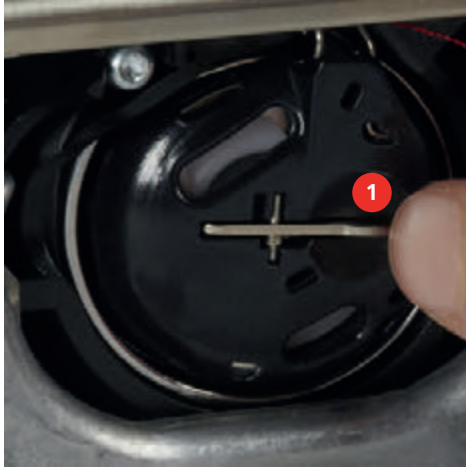

- > Remove the bobbin case.
> Remove the bobbin from the bobbin case.
> Insert the new bobbin so that the silvery sensor surface is facing the back of the bobbin case.



- > Pull the thread into the slot (2) from the left.



- > Pull the thread to the right under the spring (3), then lead the thread under the two thread guides (4) and pull upwards.



- > When inserting into the machine, hold the bobbin case so the thread guide (5) points upwards.



- > Insert the bobbin case.
- > Press onto the center of the bobbin case until it engages.
- > Pull the thread through the thread cutter (6) and cut.

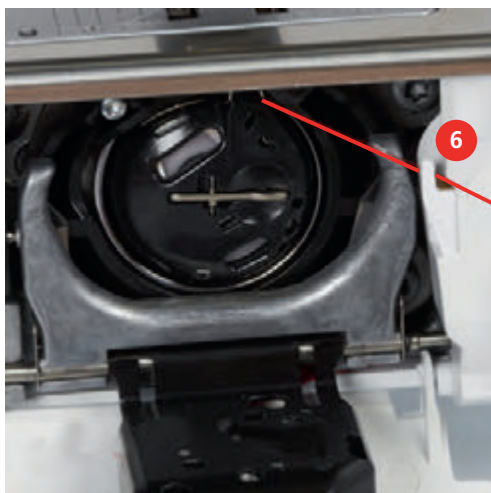

- > Close the bobbin cover.



3 Setup Program

3.1 Sewing settings

Adjusting the upper thread tension

Adjustments to the upper thread tension in the Setup Program affect all stitch patterns. Individual alteration of the upper thread tension can also be made for currently selected stitches.



> Touch the icon «Setup Program».



> Touch the icon «Sewing settings».



> Touch the icon «Alter the upper thread tension».

> Move the slide using the touchscreen pen/finger or touch the icons «+» or «-» to alter the upper thread tension.

Adjusting the maximum sewing speed

By using this function, the maximum speed can be reduced.



> Touch the icon «Setup Program».



> Touch the icon «Sewing settings».



> Touch the icon «Alter the maximum speed».

> Move the slide using the touchscreen pen/finger or touch the icons «+» or «-» to alter the maximum speed.

Programming the securing stitches

If the function is activated, 4 securing stitches are sewn automatically at the pattern start after the thread cut.



> Touch the icon «Setup Program».



> Touch the icon «Sewing settings».







> Touch the switch using the touchscreen pen/finger to deactivate the securing stitches.

> Touch the switch again to activate the securing stitches.











Adjusting the hovering height of the presser foot

The hovering height of the presser foot can be adjusted according to the fabric thickness from 0 to maximal 7 mm.

-  > Touch the icon «Setup Program».
-  > Touch the icon «Sewing settings».
-  > Touch the icon «Program buttons and icons».
-  > Touch the icon «Program the hovering position of the presser foot».
- > To adjust the distance between the fabric and the presser foot, turn the «Upper Multifunction knob» or the «Lower Multifunction knob» or touch the icons «-» or «+».

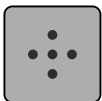
Programming the button «Pattern end»

The presser foot can be positioned, the thread cut and the automatic securing can be programmed.

-  > Touch the icon «Setup Program».
-  > Touch the icon «Sewing settings».
-  > Touch the icon «Program buttons and icons».
-  > Touch the icon «Program pattern end».
-  > Touch the icon «Secure» to sew 4 securing stitches in place.
-  > Touch the icon «Alter the number of securing stitches» to program subsequent securing stitches.
- > Touch the icons «-» or «+» to program the number of securing stitches in close succession.
-  > Touch the icon «Securing stitches in place» to program 4 securing stitches in place.
-  > Touch the icon «Thread cut» to deactivate the automatic thread cut after securing.
- > Touch the icon «Thread cut» again to activate the automatic thread cut after securing.
-  > Touch the icon «Position the presser foot» so that the presser foot remains down after securing.
- > Touch the icon «Position the presser foot» again so that the presser foot remains up after securing.
-  > Touch the icon «Secure» to deactivate the automatic securing.
- > Touch the icon «Secure» again to activate the automatic securing.

Programming the button «Thread cutter»

The automatic securing can be programmed before the thread cut takes place.



> Touch the icon «Setup Program».



> Touch the icon «Sewing settings».



> Touch the icon «Program buttons and icons».



> Touch the icon «Program the button thread cutter».



> Touch the icon «Secure» to program 4 securing stitches in place.

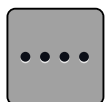

> Touch the icon «Number of securing stitches» to program the number of securing stitches in close succession.

> Touch the icons «-» or «+» to program the number of securing stitches.

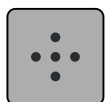

> Touch the icon «Securing stitches in place» to program 4 securing stitches in place.



> Touch the icon «Securing» to deactivate the automatic securing.

> Touch the icon «Securing» again to activate the automatic securing.

Adjusting the presser foot position with needle stop down

With lowered needle, 3 different presser foot position can be selected: the presser foot lowered, the presser foot is raised to hovering position and the presser foot is raised to its maximum height.



> Touch the icon «Setup Program».



> Touch the icon «Sewing settings».



> Touch the icon «Program buttons and icons».



> Touch the icon «Adjust the presser foot position with needle stop down».



> Select the desired presser foot position.

Programming the button «Quick reverse»

It can be chosen either «Quick reverse permanent» or «Backstepping».



> Touch the icon «Setup Program».



> Touch the icon «Sewing settings».



> Touch the icon «Program buttons and icons».



> Touch the icon «Program Quick reverse».



> Touch the icon «Backstepping» to activate backstepping.

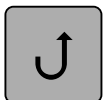

> Touch the icon «Quick reverse permanent» to activate the permanent reverse sewing.

3.2 Selecting personal settings



> Touch the icon «Setup Program».



> Touch the icon «Personal settings».
> Select the desired color of the display and the background.
> Touch the text box above the color settings.



> Enter the welcome text.
> Touch the icon «ABC» (standard setting) to use upper-case letters.
> Touch the icon «abc» to use lower-case letters.
> Touch the icon «123» to use figures and mathematical symbols.
> Touch the icon «@&!>» to use special characters.



- > Touch the text box above the keyboard to delete the entered text completely.
- > Touch the icon «DEL» to delete individual syllables of the entered text.



- > Touch the icon «Confirm».

3.3 Monitoring functions

Activating the upper thread indicator



- > Touch the icon «Setup Program».



- > Touch the icon «Monitoring settings».



- > Touch the switch to deactivate the upper thread indicator.
- > Touch the switch again to activate the upper thread indicator.

3.4 Activating the audio signals



- > Touch the icon «Setup Program».



- > Touch the icon «Audio signals».
- > Touch the switch (1) to deactivate any audio signals in general.
- > Touch the switch (1) again to activate any audio signals in general.
- > In the section (2) touch the icons «1 – 4» to set up the desired signal for the selection of a stitch pattern.



- > In the section (2) touch the icon «Loudspeaker» to deactivate the signal for the selection of a stitch pattern.
- > In the section (3) touch the icons «1 – 4» to activate the signal for the selection of functions.



- > In the section (3) touch the icon «Loudspeaker» to deactivate the signal for the selection of functions.



- > In the section (4) touch the icon «Loudspeaker» to deactivate the signal when using the BSR modes.
- > In the section (4) touch the icon «Loudspeaker» again to activate the signal when using the BSR modes.



3.5 Machine settings

Selecting a language

The User Interface can be programmed in different languages according to the customer's wish because BERNINA provides a wide range of international languages for the customers. Via firmware updates additional languages for the User Interface can be provided.



> Touch the icon «Setup Program».



> Touch the icon «Machine settings».



> Touch the icon «Language selection».
> Select a language.

Adjusting the brightness of the display

The brightness of the display can be adjusted corresponding to the personal preferences.



> Touch the icon «Setup Program».



> Touch the icon «Machine settings».



> Touch the icon «Adjust the brightness».
> Move the slide in the upper portion of the display using the touchscreen pen/finger or touch the icons «+» or «-» to alter the brightness of the display.

Adjusting the sewing light

The brightness of the sewing light can be adjusted corresponding to the personal preferences.



> Touch the icon «Setup Program».



> Touch the icon «Machine settings».



> Touch the icon «Adjust the brightness».
> Move the slide in the upper portion of the display using the touchscreen pen/finger or touch the icons «+» or «-» to alter the brightness of the sewing light.



> Touch the switch to switch the sewing light off.
> Touch the switch again to switch the sewing light on.

Calibrating the display

Please find further information on this topic in the chapter attachment below troubleshooting at the end of the instruction manual.



> Touch the icon «Setup Program».



> Touch the icon «Machine settings».



> Touch the icon «Calibrate the display».
> Touch the crosses in sequence using the touchscreen pen.

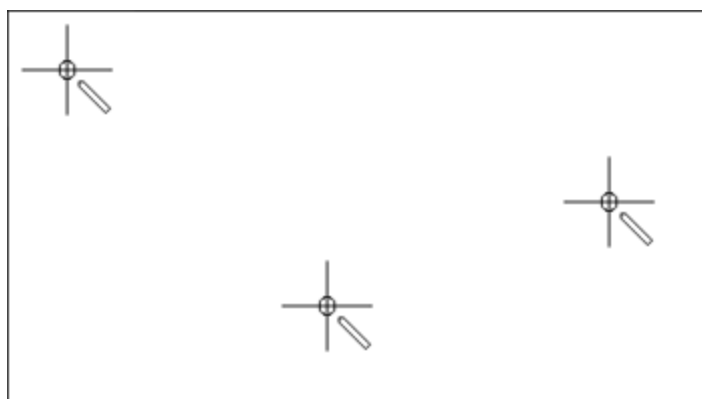

Back to basic settings

WARNING: Using this function will delete all individually made settings.



> Touch the icon «Setup Program».



> Touch the icon «Machine settings».



> Touch the icon «Default settings».



> Touch the icon «Default setting sewing».



> Touch the icon «Confirm» to restore the default settings for sewing.



> Touch the icon «Default setting all».



> Touch the icon «Confirm» and restart the machine to restore all default settings.

Deleting user data

Motifs which are not needed anymore can be deleted so that there will be more capacity for new motifs.



> Touch the icon «Setup Program».



> Touch the icon «Machine settings».



> Touch the icon «Default settings».



> Touch the icon «Delete data from the personal memory».



> Touch the icon «Confirm» to delete all data from the personal memory.

Calibrating the Buttonhole foot No. 3A

The Buttonhole foot No. 3A is calibrated to this machine and they should only be used both together.

Prerequisite:

- The Buttonhole foot No. 3A is attached.
- The needle is not threaded.



> Touch the icon «Setup Program».



> Touch the icon «Machine settings».



> Touch the icon «Maintenance/Update».



> Touch the icon «Calibrate the Buttonhole foot with slide No. 3A».

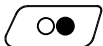

> Touch the button «Start/Stop» to start the calibration.

Updating the machine Firmware

The latest firmware of the machine and a detailed step-by-step instruction for updating processes can be downloaded at www.bernina.com. In general, personal data and settings are automatically transferred during a firmware update. For reasons of safety, it is also recommended to save data and settings on a BERNINA USB stick (optional accessory) before the firmware update is started. If personal data and settings should get lost during a firmware update, they can be transferred to the machine again afterwards.

NOTICE

The BERNINA USB stick (optional accessory) has been removed too early

Firmware has not been updated and the machine cannot be used.

> Remove the BERNINA USB stick (optional accessory) only after the update has been completed successfully.

> Insert the BERNINA USB stick (optional accessory), FAT32 formatted, providing the latest software into the port.



> Touch the icon «Setup Program».



> Touch the icon «Machine settings».



> Touch the icon «Maintenance/Update».



> Touch the icon «Update the machine».



> Touch the icon «Save data on USB stick».
– The icon is checkmarked in green.



> Touch the icon «Update» to start the update of the firmware.

Recovering saved data

If personal data and settings after a software update are not available anymore, they can be transferred to the machine again afterwards.

NOTICE

The BERNINA USB stick (optional accessory) has been removed too early





Saved data cannot be transferred and the machine cannot be used.

> Remove the BERNINA USB stick (optional accessory) only after the saved data has been transferred successfully.

> Insert the BERNINA USB stick (optional accessory) providing the saved data and settings into the USB port of the machine.







> Touch the icon «Setup Program».

-  > Touch the icon «Machine settings».
-  > Touch the icon «Maintenance/Update».
-  > Touch the icon «Update the machine».
-  > Touch the icon «Transfer saved data to machine».
– The icon is checkmarked in green.

Cleaning the thread catcher

In chapter «Maintenance and cleaning» there are additional illustrated step-by-step instructions.

-  > Touch the icon «Setup Program».
-  > Touch the icon «Machine settings».
-  > Touch the icon «Maintenance/Update».
-  > Touch the icon «Clean the thread catcher».
> Clean the thread catcher according to the instructions on the display.

Lubricating the machine



Electronically driven components

Risk of injury near the needle and the hook.

- > Switch the machine off and disconnect it from the power supply system.



Lubricating the hook

Too much oil can pollute the fabric and the thread.

- > Always sew a test sample first.

The Setup Program provides animations how to oil the machine. In chapter «Maintenance and cleaning» there are additional illustrated step-by-step instructions. Always use BERNINA oil to lubricate.



- > Touch the icon «Setup Program».



- > Touch the icon «Machine settings».



- > Touch the icon «Maintenance/Update».



- > Touch the icon «Lubricate the machine».
- > Lubricate the machine according to the instructions on the display.

Checking the firmware version

Both the firmware and the hardware version of the machine are displayed.



- > Touch the icon «Setup Program».



- > Touch the icon «Machine settings».



- > Touch the icon «Information».



- > Touch the icon «Firmware and Hardware Information».

Reviewing the total number of stitches

The total number of stitches of the machine as well as the number of stitches since the last service carried out by the specialized BERNINA dealer are displayed.



> Touch the icon «Setup Program».



> Touch the icon «Machine settings».



> Touch the icon «Information».



> Touch the icon «Firmware und Hardware Informationen».

Registering details of the dealer

The contact details of your specialized BERNINA dealer can be registered.



> Touch the icon «Setup Program».



> Touch the icon «Machine settings».



> Touch the icon «Information».



> Touch the icon «Dealer details» to enter the information of the specialized dealer.



> Touch the icon «Name of the shop» to enter the name of the specialized BERNINA dealer.



> Touch the icon «Address» to enter the address of the specialized BERNINA dealer.



> Touch the icon «Phone» to enter the telephone number of the specialized BERNINA dealer.



> Touch the icon «Internet» to enter the Internet homepage or the email address of the specialized BERNINA dealer.

Saving Service data

Service data concerning the status quo of the machine can be saved on a BERNINA USB stick (Optional accessory) and then given to the BERNINA dealer this way.

- > Insert a BERNINA USB stick (Optional accessory) which provides enough free memory space into the USB port.



- > Touch the icon «Setup Program».



- > Touch the icon «Machine settings».



- > Touch the icon «Information».



- > Touch the icon «Service data».
- > Touch the icon «LOG».
 - The icon «LOG» is outlined in white.
- > Only when the icon is not outlined in white anymore, remove the BERNINA USB Stick (Optional accessory).

4 System settings

4.1 Calling up the Tutorial

The tutorial provides information and explanations on different sections concerning sewing and the various stitches.



- > Touch the icon «Tutorial».
- > Select the desired topic to get information.

4.2 Calling up the Creative Consultant

The Creative Consultant provides information about decision support concerning sewing projects. After entering the fabric and the desired sewing project, suggestions for suitable needles, presser feet etc. are displayed.



- > Touch the icon «Creative Consultant».
- > Select the fabric to be sewn.
- > Select the sewing project.

4.3 Calling up the Help



- > Touch the window in the display where help is needed.
- > Touch the icon «Help» to start the help mode.
- > Touch the icon in the display where help is needed.
 - Assistance concerning the selected icon is displayed.

4.4 Using eco mode

During a longer interruption of work the machine can be set into a power save mode. The power save mode also serves as a child safety feature. Nothing can be selected in the display and the machine cannot be started.



- > Touch the icon «eco».
 - The display goes to sleep. The power consumption is reduced and the sewing light is off.
- > Touch the icon «eco» again.
 - The machine is ready for use.

4.5 Cancelling any alterations with «clr»

Any alterations to motifs can be reset to default setting. Exceptions are saved motifs which have been filed in the personal memory and monitoring functions.



- > Touch the icon «clr».

5 Creative sewing

5.1 Overview selection menu sewing



- | | | | |
|---|---------------------|---|-----------------|
| 1 | Practical stitches | 4 | Buttonholes |
| 2 | Decorative stitches | 5 | Quilt stitches |
| 3 | Alphabets | 6 | Personal Memory |

Selecting a stitch pattern

- > Select a stitch pattern, alphabet or buttonhole.
- > With the touchscreen pen/finger scroll up within the range of the practical stitches, alphabets or buttonholes to have more stitch patterns displayed.
- > Touch the icon «Display all the stitch patterns» (1) to scale up the view.
- > Touch the icon «Display all the stitch patterns» (1) again to downsize the stitch pattern view.



- > Touch the icon «Stitch pattern number entry» to select the stitch pattern via entering the stitch number.

5.2 BERNINA Dual Feed



It is recommended to match the presser foot pressure with the fabric. The thicker the fabric, the lower the presser foot pressure.

The BERNINA Dual Feed feeds the fabric from above and from beneath simultaneously. This provides an even and careful feed forward even for smooth and thin materials. Striped and checkered patterns can be matched perfectly by even feeding.

In general, the BERNINA Dual Feed is used for the following sewing projects:

- Sewing: All sewing applications with difficult fabrics such as for seams, zippers.
- Patchwork: With accurate stripes, blocks and with decorative stitches up to a stitch width of 9 mm.
- Appliqués: Sewing on ribbons and bias binding.

Difficult-to-work-with fabrics are:

- Velvet, normally sewn with the grain.
- Toweling.
- Jersey, especially when sewing it crosswise to knit.
- Fake fur or coated fake fur.
- Fleece-types of fabrics.
- Batted fabrics.
- Stripes and checks.
- Curtain fabrics with pattern repeats.

«Sticky» fabrics are:

- Imitation leather, coated fabrics (Dual Feed presser foot with sliding sole).

Application of the BERNINA Dual Feed



Only use presser feet with a cut-out at the center back and the labeling «D». Additional presser feet with the labeling «D» are listed in the enclosed accessory catalog.

Activate Dual Feed

- > Raise the presser foot.
- > Attach a presser foot with the designation «D».
- > Pull the dual feed down until it engages.



Deactivate Dual Feed

- > Raise the presser foot.
- > Hold the dual feed by the handle with two fingers, pull it down and then push it away from you and let it slide slowly upwards.



5.3 Regulating the speed

The sewing speed can be adjusted infinitely variable with the slide.

- > Move the slide to the left to reduce the sewing speed.
- > Move the slide to the right to increase the sewing speed.

5.4 Adjusting the upper thread tension

The default setting of the upper thread tension is determined automatically after stitch pattern is selected.

The upper thread tension is set optimally at the BERNINA factory and the machine has been tested.

Metrosene-/Seralon thread size 100/2 (Company Mettler, Switzerland) is used for upper and bobbin thread.

When of using other types of sewing threads, the optimal upper thread tension may vary. Therefore it may be necessary to adjust the upper thread tension individually according to the sewing project as well as the desired stitch pattern.

The higher the upper thread tension, the tighter the upper thread which means that the bobbin thread is pulled up to the top of the fabric. When the upper thread tension is low, the upper thread is less tightened which means that the bobbin thread is pulled up less.

Alterations of the upper thread tension affect the currently selected stitch pattern. Permanent alterations of the upper thread tension can be made in the Setup Program (see page 50).

Prerequisite:

- In the Setup Program the upper thread tension has been altered.
- > Touch the icon «Upper thread tension».



- > Move the slide with the touchscreen pen or the finger to increase or reduce the upper thread tension.



- > Touch the yellow-framed icon to reset any alterations to default setting.
- > Touch the yellow-framed icon on the left side to reset the alteration to default setting in the **Setup Program**.

5.5 Editing stitch patterns

Changing the stitch width

- > Turn the «Upper Multifunction knob» to the left to narrow the stitch width.
- > Turn the «Upper Multifunction knob» to the right to widen the stitch width.
- > To call up further setting options, touch the icon «Stitch width» (1).



Changing the stitch length

- > Turn the «Lower Multifunction knob» to the left to shorten the stitch length.
- > Turn the «Lower Multifunction knob» to the right to elongate the stitch length.
- > To call up further setting options, touch the icon «Stitch length» (1).



Correcting the balance

Different fabrics, threads and stabilizers can affect the programmed stitch patterns so that they cannot be sewn out correctly. The electronic balance can correct these deviation and the stitch pattern can be adjusted optimally to the selected fabric.

- > Select a stitch pattern or alphabet.
- > Touch the icon «i»-Dialog.



- > Touch the icon «Balance».
- A preview of the stitch pattern is displayed.



- > To correct the vertical direction of the stitch pattern, turn the «Lower Multifunction knob» until the preview of the stitch pattern is in accordance with the sewn stitch on the fabric.
- > To save the alterations, close the preview window or touch the icon «i»-Dialog.

Programming pattern repeat

Stitch patterns as well as stitch pattern combination can be repeated up to 9 times.

- > Select a stitch pattern or alphabet.
- > Touch the icon «i»-Dialog.



- > Touch the icon «Pattern repeat» once to sew the stitch pattern once.
- > Touch the icon «Pattern repeat» 2 to 9 times to repeat the stitch pattern up to 9 times.
- > Keep the icon «Pattern repeat» touched to deactivate the stitch pattern repeat.

Mirror image of stitch patterns

- > Select a stitch pattern or alphabet.
- > Touch the icon «i»-Dialog.



- > Touch the icon «Mirror image left/right» to mirror the stitch pattern from left to right.



- > Touch the icon «Mirror image up/down» to mirror the stitch pattern contrary to the sewing direction.

Editing stitch pattern length

The stitch patterns can be lengthwise extended or shortened.

- > Select a stitch pattern or alphabet.
- > Touch the icon «i»-Dialog.



- > Touch the icon «Editing stitch pattern length».
- > Move the slide with the touchscreen pen/finger to determine the length of the stitch pattern.
- > Touch the icon «+100%» (1) to extend the stitch pattern length in 100%-steps.



Quick reverse

- > Select a stitch pattern, alphabet or buttonhole.
- > Program needle stop down (permanent) to switch immediately to Quick reverse as soon as the button «Quick reverse» is pressed.
- > Program needle stop up (permanent) to sew another stitch forward before the machine switches to reverse sewing.

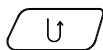

- > Push the button «Quick reverse» and keep pressed.

Permanent Quick reverse

- > Select a stitch pattern or alphabet.
- > Touch the icon «i»-Dialog.

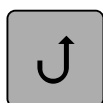

- > Touch the icon «Permanent reverse sewing» to sew permanently in reverse.
 - The machine keeps sewing in reverse until the icon «Permanent reverse sewing» is touched again.

Backstepping

- > Select a stitch pattern or alphabet.
- > Touch the icon «i»-Dialog.



- > Touch the icon «Backstepping» to backstep the last 200 stitches.

5.6 Combining stitch patterns

Overview Combi mode



- | | | | |
|---|--|---|--|
| 1 | Stitch width of the active stitch pattern | 3 | Combi mode/Single mode |
| 2 | Stitch length of the active stitch pattern | 4 | Individual stitch pattern within a combination |

Creating Stitch pattern combinations

In the Combi mode stitch patterns and alphabets can be combined according to your wish. By combining any alphabet letters, the logo BERNINA can be created.

- + > Touch the icon «Single/Combi mode».
- > Select the desired stitch patterns.



- + > Touch the icon «Single/Combi mode» again to return to the single mode.

Saving a stitch pattern combination

- > Create a stitch pattern combination.
- > Touch the icon «Personal memory».



- > Touch the icon «Save stitch pattern».



- > Touch the icon «Confirm» or the yellow-framed icon to save the stitch pattern combination.



Loading a stitch pattern combination

- + > Touch the icon «Single/Combi mode».

- > Touch the icon «Personal memory».



- > > Touch the icon «Selection of stitch pattern combination».
- > Select a stitch pattern combination.



Overwriting a stitch pattern combination

- > Create a stitch pattern combination.
- > Touch the icon «Personal memory».



- > Touch the icon «Save stitch pattern».
- > Select the stitch pattern combination which is to be overwritten.



- > Touch the icon «Confirm» to overwrite the stitch pattern combination.



Deleting a stitch pattern combination

- > Create a stitch pattern combination.
- > Touch the icon «i»-Dialog.



- > Touch the icon «Edit the whole combination».

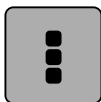

- > Touch the icon «Delete».



- > Touch the icon «Confirm».



Editing a single stitch pattern

- > Create a stitch pattern combination.
- > With the touchscreen pen/finger touch the desired position (1) within the stitch pattern combination to select a single stitch pattern.



- > Touch the icon «i»-Dialog to edit the single stitch pattern.



Deleting a single stitch pattern

- > Create a stitch pattern combination.
- > With the touchscreen pen/finger touch the desired position (1) within the stitch pattern combination to select a single stitch pattern.



- > Touch the icon «i»-Dialog.



- > Touch the icon «Delete» to delete the individual stitch pattern
- or
- > touch the desired stitch pattern (1) with the touchscreen pen/finger, keep it touched and move it outwards.
 - The stitch pattern is deleted.



Adding a single stitch pattern

The new stitch pattern is always inserted **after** the selected stitch pattern.

- > Create a stitch pattern combination.

- > With the touchscreen pen/finger touch the desired position (1) within the stitch pattern combination to select a single stitch pattern.



- > Select a new stitch pattern.

Mirroring a stitch pattern combination

- > Create a stitch pattern combination.
- > Touch the icon «i»-Dialog.

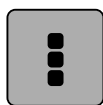

- > Touch the icon «Edit the whole combination».



- > Touch the icon «Mirror image left/right» to mirror the whole stitch pattern combination from the left to the right.
- > Touch the icon «Mirror image left/right» again to reset the alterations to default setting.

Stitch pattern combination Subdivider 1

A stitch pattern combination can be subdivided into several sections. The subdivision is placed **beneath** the cursor. Only this section is sewn where the cursor is placed. To sew the next section, the cursor must be placed in the next section.

- > Create a stitch pattern combination.
- > With the touchscreen pen/finger select the desired position within the stitch pattern combination where the stitch pattern combination is to be subdivided.
- > Touch the icon «i»-Dialog.

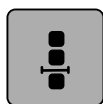

- > Touch the icon «Edit combination at cursor position».

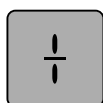

- > Touch the icon «Combination subdivider».

Stitch pattern combination Subdivider 2

A stitch pattern combination can be interrupted at several positions. The interruption is placed **beneath** the cursor.

- > Create a stitch pattern combination.
- > With the touchscreen pen/finger select the desired position within the stitch pattern combination where the stitch pattern combination is to be interrupted.
- > Touch the icon «i»-Dialog.

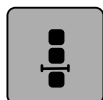

- > Touch the icon «Edit combination at cursor position».

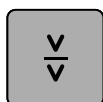

- > Touch the icon «Combination subdivider 2».
- > Sew the first section and then reposition the fabric.

Securing a stitch pattern combination

- > Create a stitch pattern combination.
- > With the touchscreen pen/finger select the desired position within the stitch pattern combination where the stitch pattern combination is to be secured.
- > Touch the icon «i»-Dialog.

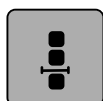

- > Touch the icon «Edit combination at cursor position».



- > Touch the icon «Securing».
 - Every single pattern of the stitch pattern combination can be secured at the start or at the end.

Programming pattern repeat

- > Create a stitch pattern combination.
- > Touch the icon «i»-Dialog.

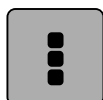

- > Touch the icon «Edit the complete combination».



- > Touch the icon «Pattern repeat» once to repeat the stitch pattern combination.
- > Touch the icon «Pattern repeat» again to repeat the stitch pattern combination up to 9 times.
- > To deactivate the pattern repeat, keep the icon «Pattern repeat» pressed or touch the icon «clr».

5.7 Administering stitch patterns

Saving settings of stitch patterns



- > Select a stitch pattern, alphabet or buttonhole.
- > Touch the icon «i»-Dialog.
- > Edit the stitch, alphabet or buttonhole.



- > Touch the icon «Saving stitch pattern settings» to save the alterations permanently.



- > Touch the icon «Back to default setting» to cancel the alterations.

Saving stitch patterns in personal memory

In the filing system «Personal memory» any stitch patterns, also those which have been individually edited, can be saved.

- > Select a stitch pattern, alphabet or buttonhole.
- > Edit the stitch pattern.
- > Touch the icon «Personal memory».



- > Touch the icon «Save stitch pattern».
- > Select the file where the pattern is to be saved.



- > Touch the icon «Confirm».

Overwriting stitch patterns from the personal memory

Prerequisite:

- The stitch pattern is saved in the personal memory.

- > Select a stitch pattern, alphabet or buttonhole.
- > Edit the stitch pattern.
- > Touch the icon «Personal memory».



- > Touch the icon «Save stitch pattern».
- > Select the file where the stitch pattern to be overwritten has been saved.
- > Select the stitch pattern which should be overwritten.



- > Touch the icon «Confirm».

Loading stitch patterns from the personal memory

Prerequisite:

- The stitch pattern is saved in the personal memory.



- > Touch the icon «Personal memory».



- > Touch the icon «Load embroidery motif».
- > Select the file where the stitch pattern has been saved.
- > Select a stitch pattern.

Deleting stitch patterns from the personal memory

Prerequisite:

- The stitch pattern is saved in the personal memory.



- > Touch the icon «Personal memory».



- > Touch the icon «Delete».
- > Select the file where the stitch pattern has been saved.
- > Select a stitch pattern.



- > Touch the icon «Confirm» to delete the stitch pattern.

Saving stitch patterns on the BERNINA USB stick

On the BERNINA USB stick stitch patterns, also those which have been individually edited, can be saved.

- > Select a stitch pattern, alphabet or buttonhole.
- > Edit the stitch pattern.
- > Touch the icon «Personal memory».



- > Touch the icon «Save stitch pattern».
- > Insert the BERNINA USB stick into the USB port of the machine.



- > Touch the icon «USB Stick».



- > Touch the icon «Confirm».

Uploading a stitch pattern from the BERNINA USB stick



- > Touch the icon «Personal memory».



- > Touch the icon «Load stitch pattern».

- > Touch the icon (1).

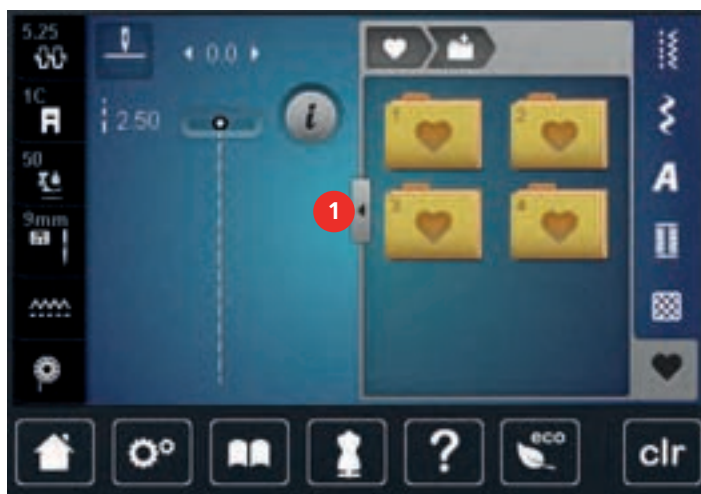

- > Insert the BERNINA USB stick into the USB port of the machine.
- > Touch the icon «USB stick».
- > Select the desired stitch pattern.

Deleting stitch patterns from the BERNINA USB stick



- > Touch the icon «Personal memory».



- > Touch the icon «Delete».
- > Insert the BERNINA USB stick into the USB port of the machine.
- > Select the stitch pattern which is to be deleted.



- > Touch the icon «Confirm».

5.8 Securing

Securing with the button «Pattern end»

The button «Pattern end» can be programmed with various functions.



- > Push the button «Pattern end» before sewing is started or while sewing.
 - While sewing, a stop icon indicates that the function is activated and the stitch pattern or the current combination of a stitch pattern will be secured at the end with the programmed number of stitches.

Securing via the icon «Securing»

Every single pattern of a stitch pattern combination can be secured either at the beginning or at the end.



- > Touch the icon «i»-Dialog.



- > Touch the icon «Securing» before starting to sew.
 - The stitch pattern/stitch pattern combination is secured with 4 stitches at the beginning.
- > Touch the icon «Securing» while sewing.
 - The stitch pattern or the active stitch pattern of the stitch pattern combination is secured with 4 stitches at the end.

5.9 Height Compensation of uneven layers

If the presser foot is at an angle when sewing over a thick seam, the feed dog cannot grip the fabric and the sewing project cannot be sewn out properly.

- > Place 1 – 3 compensating plates as required from the back of the presser foot close to the needle to level the fabric layer.

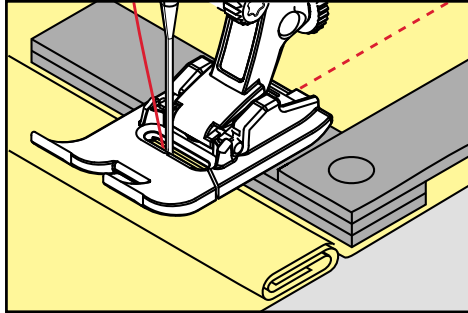

- The presser foot is leveled with the sewing project.

- > Place 1 – 3 compensating plates as required from the front of the presser foot close to the needle to level the fabric layer.

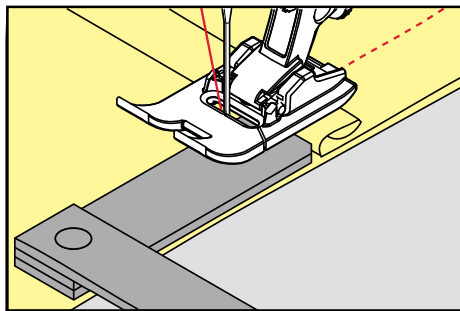

- The presser foot is leveled with the sewing project.

- > Sew until the complete presser foot has passed the thick seam.
- > Remove the plates of the height compensation.

5.10 Sewing Corners

When sewing corners, only a small section of the fabric is actually on the feed dog. Therefore it cannot grip the fabric well. By means of the height compensation tool the fabric can be fed evenly.

- > When the fabric edge is reached, stop the sewing process with needle position down.
- > Raise the presser foot.
- > Turn the fabric and place in desired position.
- > Place 1 – 3 compensating plates as required on the right of the presser foot close to the sewing project.
- > Lower the presser foot.

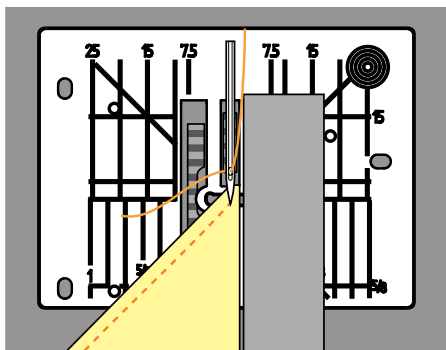

- > Resume sewing until the sewing project is on the feed dog again.





















6 Practical stitches

6.1 Overview Practical stitches



Stitch pattern	Number of stitch pattern	Name	Description
---	1	Straight stitch	Seams and topstitching.
W	2	Zig zag	Reinforcing seams, overcasting edges, sewing elastic seams and attaching lace.
W	3	Vari overlock	Sewing and finishing in one step of elastic fabrics.
W	4	Running stitch	Darning with running stitch, mending fabrics, reinforcing edges.
W	5	Securing program	Securing starts and ends of seams by straight stitching.
---	6	Triple Straight stitch	Reinforced seams in heavy fabrics; visible hems and seams.
W	7	Triple Zig zag	Reinforced seams in heavy fabrics; visible hems and seams.
W	8	Honeycomb stitch	For stretch fabrics and hems. Is also used with elastic thread in the bobbin.
W	9	Blind stitch	Blind hems, shell edging effect on soft jerseys and fine material, decorative seams.
W	10	Double overlock	Sewing and finishing in one step of elastic fabrics.

Stitch pattern	Number of stitch pattern	Name	Description
	11	Superstretch stitch	For highly stretch fabrics. For all types of clothing.
	12	Gathering stitch	Most types of fabric; gathering with elastic, butted seams = butting two pressed edges and sewing together, decorative stitches.
	13	Stretch overlock	Sewing and finishing in one step of elastic fabrics.
	14	Tricot stitch	Visible hems, visible seams in lingerie, sweaters, mending jersey.
	15	Universal stitch	For firm fabrics such as felt and leather. Flat joining seams, visible seams, attaching elastic, decorative seams.
	16	Sewn-out Zig zag	Edge finishing and reinforcing, attaching elastic, decorative seam.
	17	Lycra stitch	For lycra fabrics; flat joining seams and hems, reinforced seaming on underwear.
	18	Stretch stitch	For highly stretch fabrics; open seam for sportswear.
	19	Reinforced overlock	Medium-weight knits and toweling. Overlock seams, flat joining seams.
	20	Knit overlock	Sewing and finishing in one step of hand-knitted and machine-knitted fabrics.
	22	Simple Darning Program	Darning of holes and damaged fabric.
	23	Reinforced Darning Program	Reinforcing darning holes and damaged fabric.
	24	Bartack Program	Reinforcing pocket openings, sewing belt loops.
	25	Bartack Program	Reinforcing pocket openings, sewing on belt loops, securing zippers and seam ends.
	26	Large Fly stitch	Reinforcing pocket openings, zippers and slits in medium-weight to thick fabrics.
	29	Narrow blindstitch	For blind hems in fine fabrics.

Stitch pattern	Number of stitch pattern	Name	Description
	30	Basting stitch	For basting seams, hems, quilts etc.
	32	Single Straight stitch	Used as a connecting stitch in a combination.
	33	Three single Straight stitches	As connecting stitches in a combination.

6.2 Sewing straight stitch

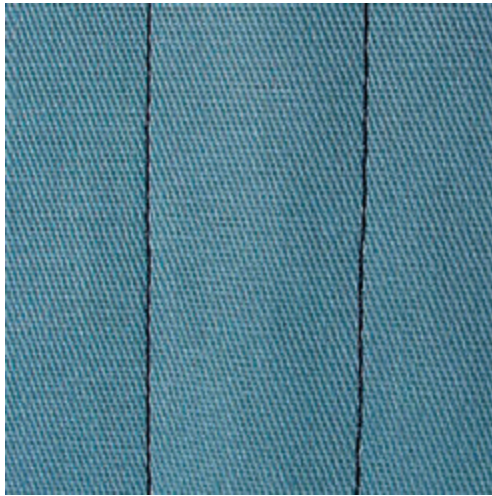

Match the stitch length with the sewing project, which means for denim fabrics long stitches (ca. 3 – 4 mm), for fine fabrics short stitches (ca. 2 – 2.5 mm). Match the stitch length with the thread size, e.g. long stitches when topstitching with Cordonnet (ca. 3 – 5 mm).

Prerequisite:

- The Reverse pattern foot No.1C/1D is attached.
- > Touch the icon «Practical stitches».
- > Select the Straight stitch No. 1.



6.3 Securing with the automatic Securing Program

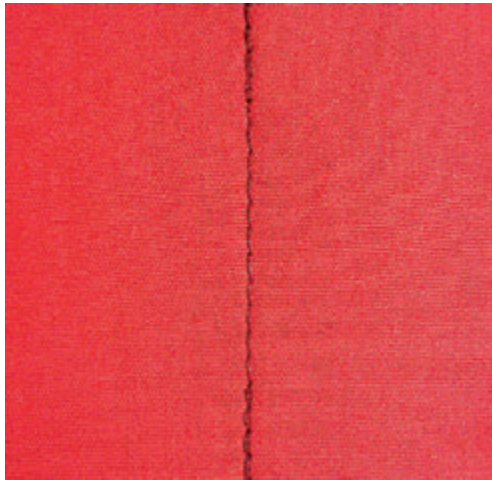

Due to a determined number of 5 stitches sewn forward and 5 stitches sewn backward, the securing is regular.

Prerequisite:

- The Reverse pattern foot No. 1C is attached.



- > Touch the icon «Practical stitches».
- > Select the Securing Program No. 5.
- > Press the foot control.
 - The machine secures automatically.

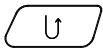

- > Sew the seam in the desired length.
- > Push the button «Quick reverse».
 - The machine secures automatically and stops at the end of the securing program.

6.4 Sewing in the zipper

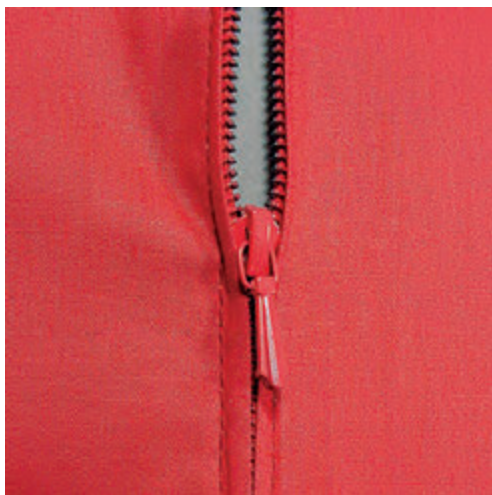

As the fabric feed can be difficult when starting to sew, it is recommended to hold the threads firmly or to pull the fabric slightly to the back for a few stitches or to sew 1 – 2 cm reverse first.

- > Attach the Reverse pattern foot No. 1C.



- > Touch the icon «Practical stitches».
- > Select the Straight stitch No. 1.
- > Sew the seam up to where the zipper starts.
- > Sew the securing stitches.
- > Close the zipper length with long stitches.
- > Finish the seam allowances.
- > Iron the seam.
- > Open the zipper length.
- > Baste the zipper under the fabric so that the fabric folded edges meet over the center of the zipper.
- > Open the zipper a few centimeters.
- > Attach the Zipper foot No. 4D.
- > Move the needle position to the right.
- > Use the Free Hand System to raise the presser foot and to position the sewing project.
- > Start sewing from top left.
- > Guide the foot so that the needle stitches along the zipper coils.
- > Stop in front of the zipper pull with needle position down.
- > Raise the presser foot.
- > Close the zipper.
- > Continue to sew and stop in front of the base of the zipper with needle position down.
- > Raise the presser foot and turn the sewing project.
- > Sew across the other side of the zipper and stop with needle position down.
- > Raise the presser foot and turn the sewing project.
- > Sew the second side from bottom to top.

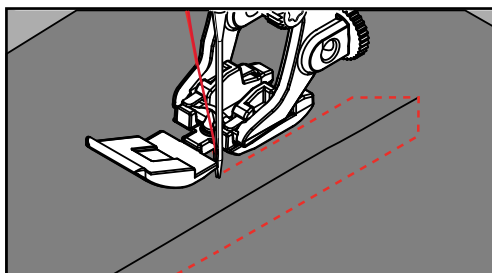

6.5 Sewing both sides of the zipper from bottom to top

For fabrics with pile, such as velvet, it is recommended to sew in the zipper on both sides from bottom to top.



When the fabric is densely woven or hard, it is recommended to use a needle with the size 90 – 100. This results in an even stitch formation.



- > Attach the Reverse pattern foot No. 1C.
- > Touch the icon «Practical stitches».
- > Select the Straight stitch No. 1.
- > Sew the seam up to where the zipper starts.
- > Sew the securing stitches.
- > Close the zipper length with long stitches.
- > Finish the seam allowances.
- > Iron the seam.
- > Open the zipper length.
- > Baste the zipper under the fabric so that the fabric folded edges meet over the center of the zipper.
- > Attach the Zipper foot No. 4D.
- > Move the needle position to the right.
- > Use the Free Hand System to raise the presser foot and to position the sewing project.

- > Start sewing in the center of the seam at the end of the zipper.
- > Sew diagonally along the edge of the zipper coils.
- > Sew the first side (1) from bottom to top.
- > Stop in front of the zipper pull with needle position down.
- > Raise the presser foot.
- > Open the zipper as far as behind the presser foot.
- > Lower the presser foot and continue sewing.
- > Sew the second side (2) in exactly the same way from bottom to top.

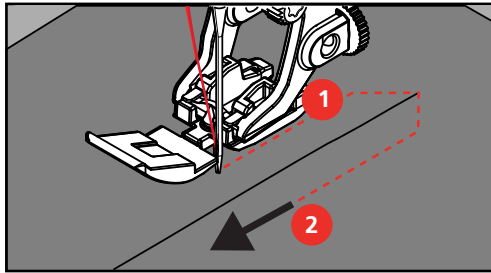

6.6 Sewing Triple straight stitch



The triple straight stitch is especially suitable for durable seams and for firm, densely woven fabrics such as denim and corduroy. For firm or densely woven materials it is recommended to attach the Jeans foot No. 8. This will help to sew denim or canvas. For decorative topstitching the stitch length can be elongated.

- > Attach the Reverse pattern foot No. 1C/1D.
- > Touch the icon «Practical stitches».
- > Select the Triple straight stitch No. 6.



6.7 Sewing Triple zig zag

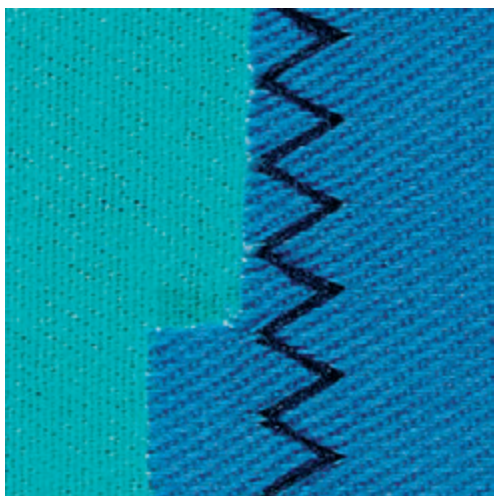

For firm materials such as denim, deckchair covers, awnings or frequently washed items. Finish raw edges first.



- > Attach the Reverse pattern foot No. 1C/1D.
- > Touch the icon «Practical stitches».
- > Select the Triple zig zag No. 7.

6.8 Manual darning

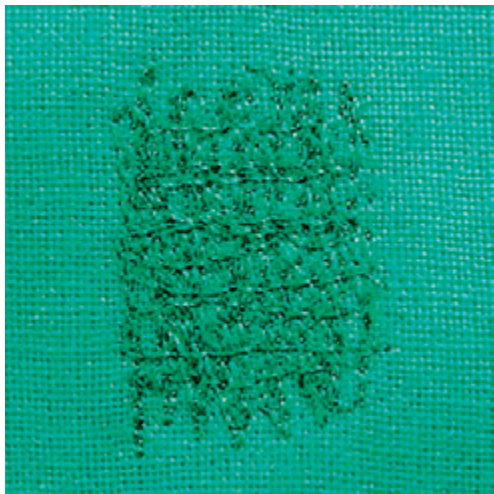

Used for darning holes or worn areas in all fabric types.

If the thread is lying on top and a poor stitch formation results, slow down the movement of the sewing project. If there are knots on the wrong side of the fabric, move the sewing project faster. When the thread breaks, guide the sewing project more consistently.



- > Attach the Darning foot No. 9 (optional accessory).
- > Touch the icon «Practical stitches».
- > Select the Straight stitch No. 1.
- > Lower the feed dog.
- > Attach the slide-on table.
- > Hoop the sewing project in the round embroidery hoop (optional accessory).
 - The area to be darned stays evenly taut and cannot be distorted.

- > Sew from the left to the right, guide the fabric evenly by hand without using pressure.
- > Move in curves when changing the direction to avoid holes and thread breakage.
- > Work the rows in irregular lengths so that the thread is better spread over the fabric.

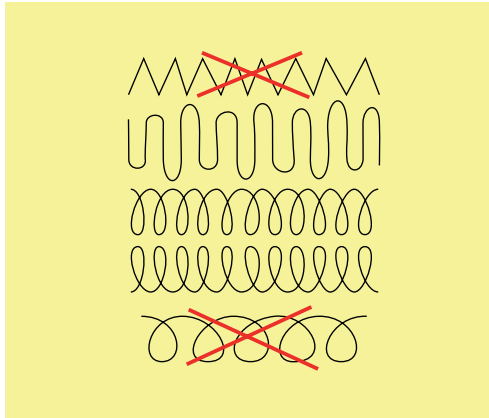

- > Sew the first rows not too close together and beyond the worn area.
- > Sew the rows in irregular lengths.

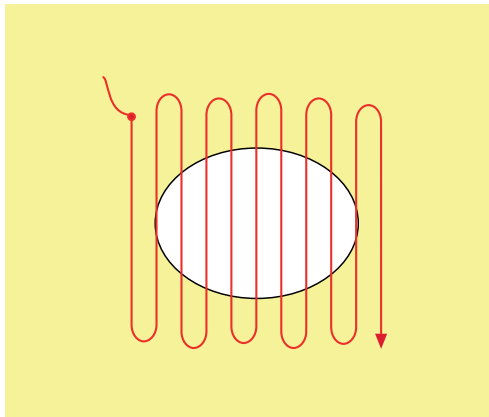

- > Turn the sewing project by 90°.
- > Sew the first rows not too close.

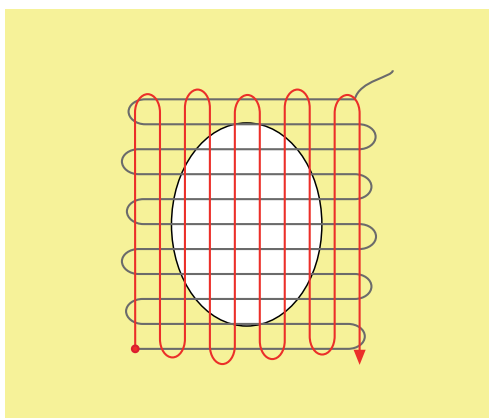

- > Turn the sewing project by 180°.

6.10 Reinforced darning, automatic



The reinforced Darning Program No. 23 is especially suitable for quick darning of thin areas or snags. The reinforced Darning Program No. 23 replaces longitudinal threads in all fabrics.



If the Darning Program does not cover the whole worn or damaged area, it is recommended to reposition the work and sew the Darning Program again. The length is programmed and can be repeated as often as desired.



- > Attach the Buttonhole foot No. 3A.
- > Touch the icon «Practical stitches».
- > Select the reinforced Darning Program No. 23.
- > Hoop light-weight materials in the round embroidery hoop (optional accessory).
 - The darning area stays evenly taut and cannot be distorted.
- > Start sewing top left.
- > Sew the first row.
- > Stop the machine.

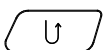

- > Push the button «Quick reverse».
 - The darning length is programmed.
- > Finish sewing the Darning Program.
 - The machine stops automatically.

6.11 Finishing edges



The Zig zag No. 2 is suitable for all materials. It can also be used for elastic seams as well as for decorative sewing. Use darning thread for fine materials. When sewing satin stitch it is recommended to select a dense, short the zig zag with a stitch length of 0.3 – 0.7 mm. The satin stitch can be used for appliqué and for embroidering.

Prerequisite:

- The edge of the fabric should lie flat and not roll.
- > Attach the Reverse pattern foot No. 1C.
- > Touch the icon «Practical stitches».
- > Select the Zig zag No. 2 or the Satin stitch No. 1354.
- > Neither select too wide a stitch nor too long a stitch.
- > Guide the edge of the fabric into the center of the presser foot, so that the needle goes into the fabric on one side and over the edge into the air on the other side.



6.12 Sewing Double overlock

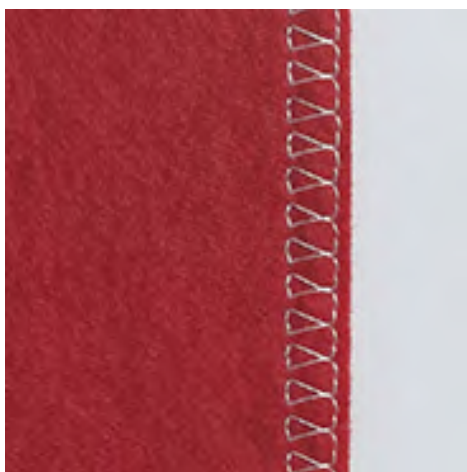

A double overlock seam is suitable for loose knits and cross seams in knits. When working with jersey, a jersey needle should be used to prevent damaging the knit fabric. When sewing stretch materials, use a stretch needle.

- > Attach the Reverse pattern foot No. 1C or the Overlock foot No. 2A (Optional accessory).
- > Touch the icon «Practical stitches».
- > Select the Double overlock No. 10.



6.13 Narrow edgestitching

- > Attach the Blindstitch foot No. 5 (optional accessory) or the Reverse pattern foot No. 1C or the Edge stitch foot No. 10/10C/10D (optional accessory).
- > Touch the icon «Practical stitches».
- > Select the Straight stitch No. 1.
- > Place the edge on the left against the guide of the Blindstitch foot.
- > Select the needle position left at the desired distance to the edge.

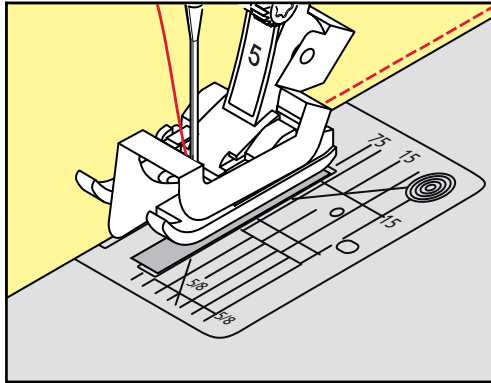

6.14 Wide edgestitching

- > Attach the Blindstitch foot No. 5 (optional accessory) or the Reverse pattern foot No. 1C or the Edge stitch foot No. 10/10C/10D (optional accessory).
- > Touch the icon «Practical stitches».
- > Select the Straight stitch No. 1.
- > Guide the edge along the presser foot or at a distance of 1 – 2.5 cm along the marks on the stitch plate.
- > Select the needle position at the desired distance to the edge.

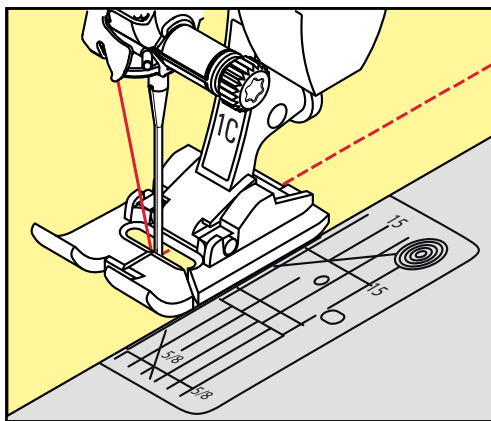

6.15 Edgestitching using the seam guide

When sewing parallel wider lines, it is recommended to guide the seam guide along the sewn of lines.

- > Attach the Reverse pattern foot No. 1C or the Edge stitch foot No. 10/10C/10D (optional accessory).
- > Touch the icon «Practical stitches».
- > Select the Straight stitch No. 1.
- > Loosen the screw on the back of the presser foot.
- > Insert the seam guide into the hole of the presser foot.
- > Adjust the width as desired.
- > Tighten the screw.
- > Guide the folded edge along the seam guide.

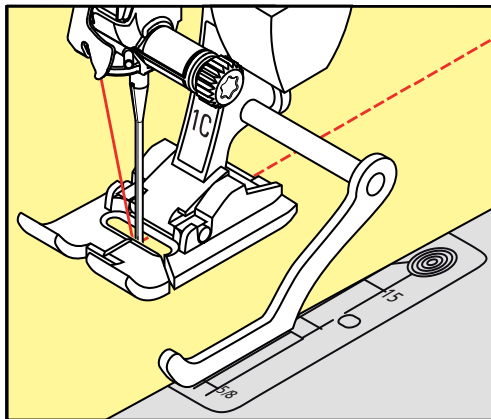

6.16 Sewing hem edges

When using the Blindstitch foot No. 5, it is recommended to select a needle position far left or far right.

When using the Reverse pattern foot No. 1C or the Edge stitch foot No. 10/10C/10D, all needle positions are possible.

- > Attach the Blindstitch foot No. 5 (optional accessory) or the Reverse pattern foot No. 1C or the Edge stitch foot No. 10/10C/10D (optional accessory).
- > Touch the icon «Practical stitches».
- > Select the Straight stitch No. 1.
- > Place the inside upper edge right against the guide of the Blindstitch foot.
- > Select the needle position far right to sew along the upper edge.

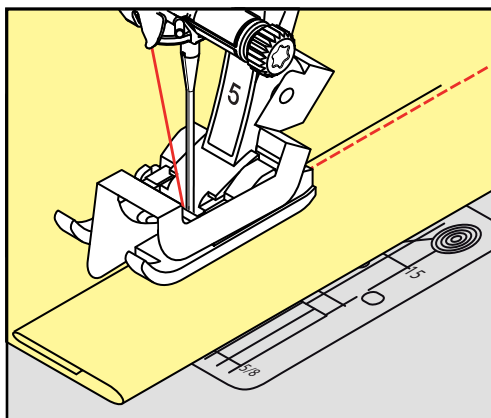

6.17 Sewing blind hems

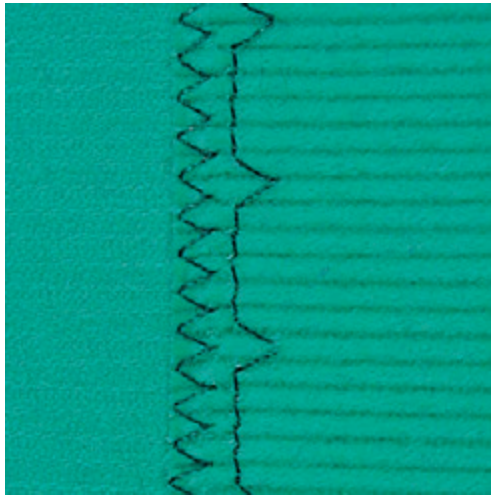

For invisible hems in medium to heavy weight cotton, wool and blended materials.

Prerequisite:

- The raw edges are finished.
- > Attach the Blindstitch foot No. 5 (optional accessory).
- > Touch the icon «Practical stitches».
- > Select the Blindstitch No. 9.
- > Fold the fabric back over the right side of the fabric to expose the finished lower edge.
- > Place the fabric under the presser foot and move the folded edge against the metal guide on the presser foot.
- > Guide the folded edge evenly along the metal guide of the foot to sew the stitches evenly deep.
 - Make sure that the needle only pierces the edge of the fold.
- > Check the blind hem on both fabric sides again after about 10 cm and adjust the stitch width if necessary.

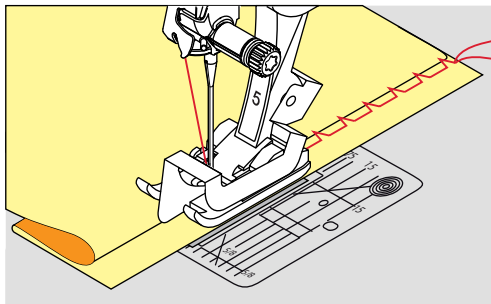

6.18 Sewing visible hems

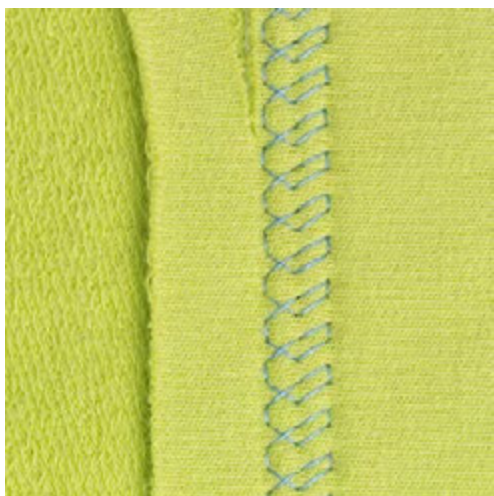

The visible hem is especially suitable for elastic hems in jersey, cotton, wool, synthetic and mixed fibers.



- > Attach the Reverse pattern foot No. 1C/1D.
- > Touch the icon «Practical stitches».
- > Select Tricot stitch No. 14.
- > Iron the hem and baste if necessary.
- > Reduce the presser foot pressure if necessary.
- > Sew the hem at the preferred depth on the right side.
- > Trim the excess fabric from the wrong side.

6.19 Sewing flat joining seams

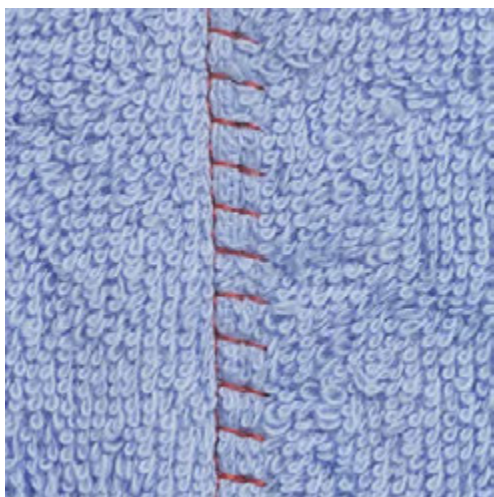

The flat joining seam is especially suitable for or thick materials such as terry cloth, felt and leather.



- > Attach the Reverse pattern foot No. 1C.
- > Touch the icon «Practical stitches».
- > Select the Stretch overlock No. 13.
- > Overlap the fabric edges.
- > Sew along the fabric edge.
- > The needle stitches over the edge of the top layer on the right side into the bottom layer to get a very flat durable seam.

6.20 Sewing basting stitches

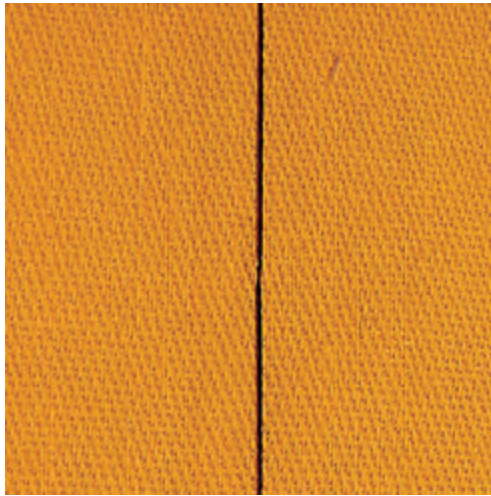

For basting it is recommended to use a thin darning thread. It can be removed easily. The basting stitch is suitable for work where a large stitch length is desired.

- > Attach the Darning foot No. 9 (optional accessory).
- > Lower the feed dog.
- > Touch the icon «Practical stitches».
- > Select the Basting stitch No. 30.
- > Pin the fabric layers at a right angle to basting direction to prevent the layers from slipping.
- > Hold the threads and sew 3 – 4 securing stitches at the beginning.
- > Sew a stitch and pull the fabric back at the desired stitch length.
- > Sew a stitch.
- > At the end sew 3 – 4 securing stitches.



7 Decorative stitches

7.1 Overview Decorative Stitches

simple or more complex decorative stitches should be selected to best suit the material.

- Decorative stitches which are programmed with simple straight stitches are particularly appropriate for light-weight materials, e.g. the Decorative stitch No. 101.
- Decorative stitches which are programmed with triple straight stitches or with a few satin stitches are particularly appropriate for medium-weight materials, e.g. Decorative stitch No. 107.
- Decorative stitches which are programmed with satin stitches are particularly appropriate for heavy-weight materials, e.g. Decorative stitch No. 401.

For a perfect stitch formation it is of advantage to use the same thread color for upper and bobbin thread and a stabilizer. With pile or longfiber materials, it is recommended to use an additional, water-soluble stabilizer on the right side, which can be easily removed after sewing.



Decorative stitch	Category	Name
	Category 100	Natural stitches
	Category 300	Cross stitches
	Category 400	Satin stitches
	Category 600	Ornamental stitches
	Category 700	Heirloom stitches
	Category 900	Novelty

7.2 Bobbin-Play

NOTICE

Inappropriate bobbin case is used

Damage of the bobbin case.

> Use the Bobbinwork bobbin (optional accessory).



The bobbin can be filled with different thread material. For free-motion stitching to add texture. This method is similar to «normal» free-motion sewing, but is done on the **wrong** side of the fabric.

Reinforce the area to be sewn with embroidery stabilizer. The design can be drawn on the wrong side of the fabric. You can also draw the design on the front side of the fabric. The lines can be followed with a freely guided straight stitch using polyester, cotton or rayon thread. The rows of stitching are visible on the right side of the fabric, and serve as reference lines for the bobbin-thread sewing.

The BSR function can be used for bobbin-thread sewing. It is recommended to guide your project at consistent speed evenly under the needle, following the lines of the design. The stabilizer must be removed after sewing.

Sew a test piece first to check what the result looks like on the wrong side of the fabric.

Not all decorative stitches are suitable for this technique. Simple decorative stitches provide best results. Avoid compact stitch types and satin stitches.

> Attach the Embroidery foot No. 20C or No. 20D (optional accessory).

> Touch the icon «Decorative stitches».

> Select an appropriate decorative stitch.

> Turn the «Upper Multifunctional knob» and the «Lower Multifunctional knob» to adjust the stitch length and the stitch width so that even when sewing with thick thread a nice stitch formation can be achieved.

> Touch the icon «Upper thread tension» to adjust the upper thread tension if necessary.



7.3 Sewing cross stitches



Cross stitching is a traditional technique, and extends the range of decorative stitches. If the cross stitches are sewn on fabric with a linen texture, they look like hand-stitched cross stitching. When cross stitches are sewn with cotton embroidery thread, the stitch pattern appears fuller. Cross stitches are particularly used for home furnishing, trimmings on garments and embellishing in general. As every following line refers to the first row, it is important to stitch the first row in a straight line.

- > Attach the Reverse pattern foot No. 1C/1D or the Open Embroidery foot No. 20C or the Embroidery foot No. 20D (optional accessory).
- > Select a cross stitch of the Category 300 and combine it as desired.
- > Stitch the first row using the seam guide or slide-on table seam guide to sew a straight line.
- > Stitch the second row next to the first at a distance of one presser foot's width or using the seam guide.

7.4 Pintucks





Pintucks

The technique reduces the size of the fabric piece. It is always advisable to plan in sufficient fabric. Pintucks are narrow stitched folds, which are normally sewn on the fabric before cutting out the pieces for the garment or the sewing project. They are suitable for embellishing or in combination with other heirloom embroidery techniques.

A more distinctive and relief-like effect can be achieved when the pintucks are corded, which means that they are sewn with an additional pintuck cord. Choose a pintuck cord that fits well into the grooves of the selected pintuck foot. The cord must be colorfast and shrink-proof.

Overview pintucks

Pintuck foot	Number	Description
	# 30 (optional accessory)	3 grooves For heavy-weight fabrics. In combination with the 4 mm double needle

Pintuck foot	Number	Description
	# 31 (optional accessory)	5 grooves For heavy to medium-weight fabrics. In combination with the 3 mm double needle
	# 32 (optional accessory)	7 grooves For light to medium-weight fabrics. In combination with the 2 mm double needle
	# 33 (optional accessory)	9 grooves For very light fabrics (without pintuck cord). In combination with the 1 or 1.6 mm double needle
	# 46C (optional accessory)	5 grooves In combination with the 1.6 – 2.5 mm double needle For very light to medium-weight fabrics.

Inserting the cord

- > Switch the machine off and disconnect it from the power supply system.
- > Remove the needle.
- > Remove the presser foot.
- > Remove the stitch plate.
- > Open the bobbin cover.
- > Pull the cord through the hook opening from the bottom and through the opening of the stitch plate.
- > Replace the stitch plate.
- > Close the bobbin cover.
- > Make sure that the cord slides through the thread slot of the bobbin cover.

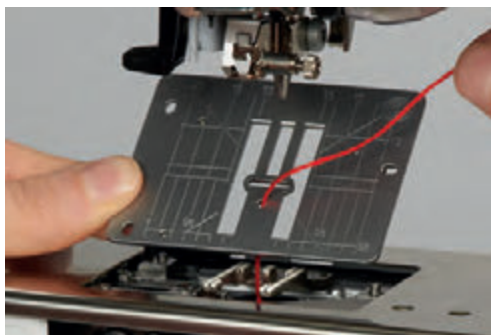

- > Place the cord spool on the knee lifter.

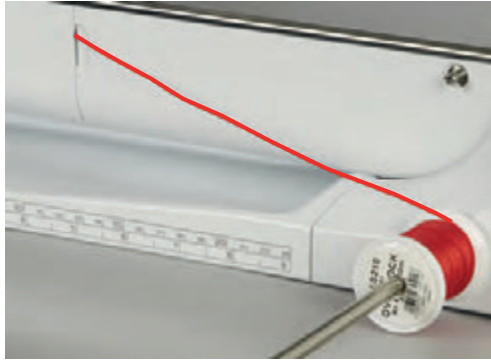

- > Check that the cord runs smoothly.
- > If the thread doesn't glide smoothly at the hook cover, leave the hook cover open.
- > If the hook cover is opened, deactivate the lower thread indicator in the Setup Program.

Sewing Pintucks

The cord lies on the wrong side of the material and is held/sewn over by the bobbin thread.

- > Sewing the first pintuck.
- > Place the first pintuck in one of the side grooves in the presser foot.
- > Sew additional pintucks parallel.



8 Alphabets

8.1 Overview Alphabet

Block, Double block, Script and Quilt alphabets as well as Cyrillic can be sewn in two different sizes. Block, Double block, Script and Quilt alphabets as well as Cyrillic can also be sewn in lower case letters.

For a perfect stitch formation, use the same thread color for upper and bobbin threads. The fabric can be reinforced with embroidery stabilizer on the wrong side. Use an additional, water-soluble stabilizer on the right side of pile or napped fabrics.

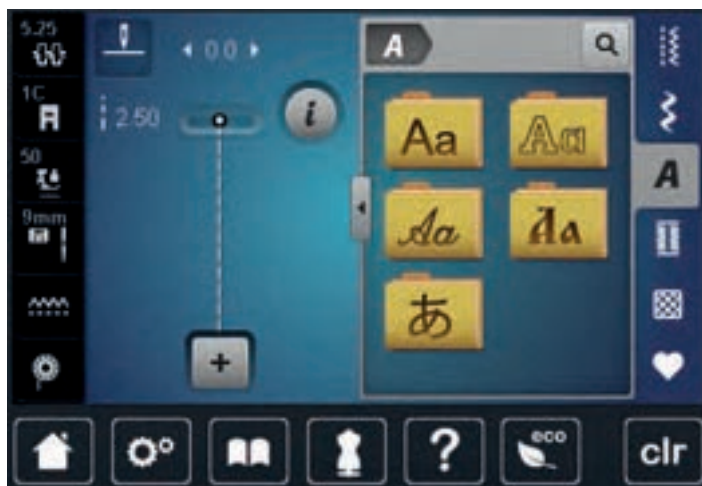

Stitch pattern	Name
ABCabc	Block alphabet
ABCabc	Double-Block
<i>ABCabc</i>	Script (Italics)
АВВабв	Cyrillic
あいう	Hiragana

8.2 Creating lettering



It is recommend to sew a test sample using the desired thread, the original fabric and the original stabilizer. Please make sure that the fabric is fed evenly and lightly without colloding and being caught. Do not pull, push or hold the fabric while sewing.



- > Touch the icon «Alphabets».
- > Select the font.



- > Touch the icon «Single/Combi mode» to create a combination.

- > Touch the icon «Display alphabets» (1) to open an extended enter mode.



- > Select the letters.
- > Touch the icon (2) (standard setting) to use upper case letters.
- > Touch the icon (3) to use lower case letters.
- > Touch the icon (4) to use figures.
- > Touch the icon (5) to use special characters and mathematical symbols.



- > Touch the icon «DEL» to delete single letters of the entered text.
- > Touch the icon «Display alphabets» again to close the extended enter mode.

8.3 Altering font size

Block, Double block, Script and Comic alphabets as well as as Cyrillic can be downloaded.



- > Touch the icon «Alphabets».
- > Select the font.
- > Select the letters.



- > Touch the icon «i»-Dialog.

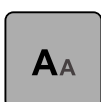









- > Touch the icon «Altering font size» to downsize the lettering.
- > Touch the icon «Altering font size» again to to scale up the lettering to 9 mm.





9 Buttonholes

9.1 Overview Buttonholes

To create the correct buttonhole for every button, every purpose and for every garment, your BERNINA 740 is equipped with a considerable collection of buttonholes. The corresponding button can be sewn on automatically. Eyelets can also be sewn.



Buttonhole	Buttonhole number	Name	Description
	51	Standard buttonhole	For light to medium-weight fabrics; blouses, dresses, bedlinen.
	52	Standard buttonhole narrow	For light to medium-weight fabrics; blouses, dresses, children's and baby clothes, crafts.
	53	Stretch buttonhole	For any highly elastic jersey made from cotton, wool, silk and synthetic fibers.
	54	Round buttonhole with normal bartack	For light to medium-weight fabrics; dresses, jackets, coats, rainwear.
	56	Keyhole buttonhole	For heavy-weight, non-stretch fabrics; jackets, coats, leisure wear.
	57	Keyhole buttonhole with pointed bartack	For firm, non-stretch fabrics: jackets, coats, leisure wear.
	59	Straight stitch buttonhole	Program for staystitching buttonholes, for pocket openings, reinforcing buttonholes, especially for buttonholes in leather and imitation leather.
	63	Heirloom	For light to medium-weight woven fabrics; blouses, dresses, leisure wear, bedlinen.

Buttonhole	Buttonhole number	Name	Description
	69	Decorative buttonhole with double pointed bartack	For decorative buttonholes in firmer, non-elastic fabrics.
	60	Button sewing-on program	For buttons with 2 and 4 holes.
	61	Eyelet with small zig zag	Openings for cords and narrow ribbons, for decorative work.
	62	Straight-stitch eyelet	Openings for cords and narrow ribbons, for decorative work.

9.2 Making use of the height compensation tool

When a buttonhole is to be sewn at right angles to the project edge, it is recommended to use the height compensation plates (optional accessory).

- > Place the plates from the back between the sewing project and the bottom of the slide to the thick part of the sewing project.

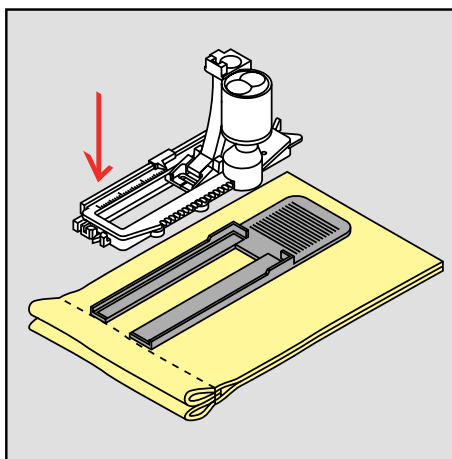

- > Lower the presser foot.

9.3 Using the compensation plate

When sewing a buttonhole in difficult materials, it is recommended to use the compensation plate for buttonholes (optional accessory). It can be used along with the Buttonhole foot No. 3A.

- > Insert the compensation plate carefully from the side.

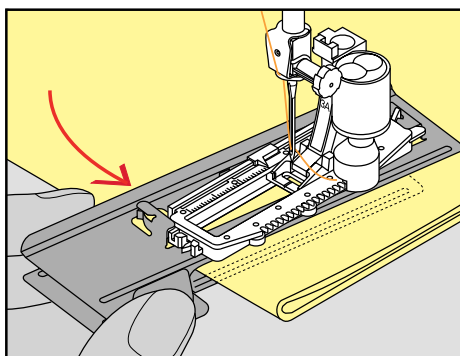

9.4 Marking buttonholes

- > For the buttonholes to be sewn manually, mark the position and the length on the fabric using chalk or a water-soluble pen.

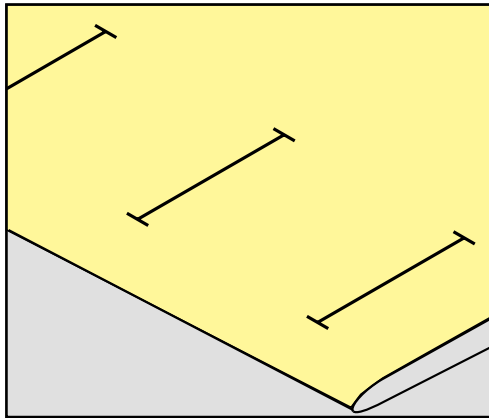

- > For the buttonholes to be sewn automatically, mark the complete length of 1 buttonhole on the fabric using chalk or a water-soluble pen. For any subsequent buttonholes mark the starting point.

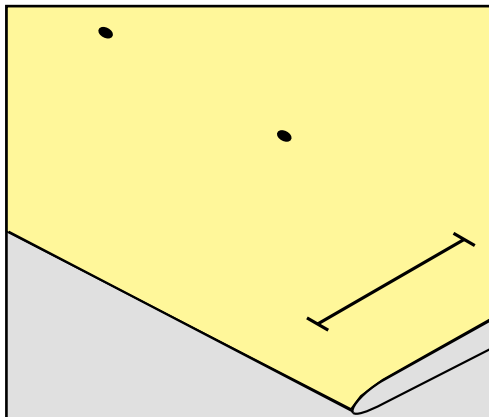

- > For keyhole and round buttonholes mark the length of the bead with chalk or a water-soluble pen on the fabric. For any subsequent buttonholes mark the starting point. The length of the keyhole is sewn additionally.

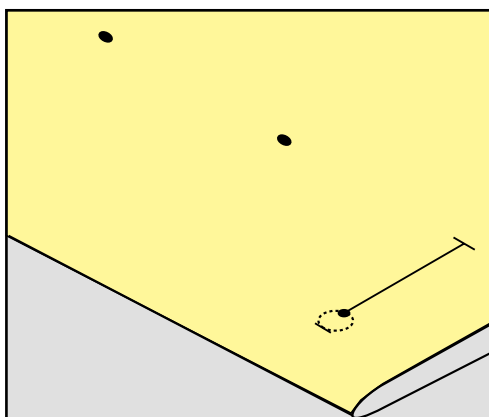

9.5 Cord

Using cord with the Buttonhole foot with slide No. 3A

Cords reinforce buttonholes and enhance their appearance and suit best for the Buttonhole No. 51. Ideal cords are Perle cotton No. 8, strong hand-sewing thread and fine crochet yarn. It is recommended to not hold the cord while sewing.

Prerequisite:

- The Buttonhole foot with slide No. 3A is attached and raised.
- > Insert the needle at the beginning of the buttonhole.
- > Guide the cord on the right side under the buttonhole foot.
- > Hook the cord over the pin at the back of the buttonhole foot.

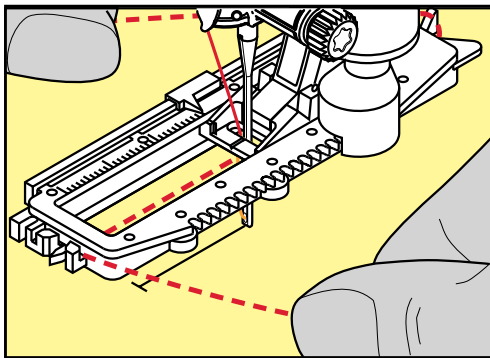

- > Pull the cord on the left side under the buttonhole foot to the front.

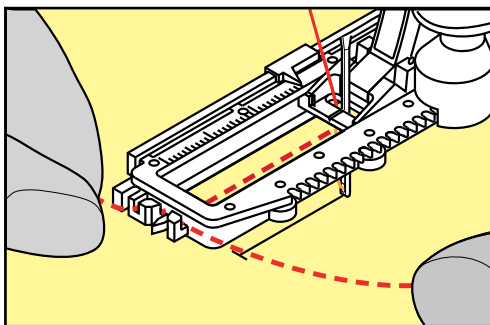

- > Pull the cord ends into the slits.
- > Lower the buttonhole foot.
- > Sew the buttonhole in the usual manner.
- > Pull the cord through the buttonhole until the loop disappears in the bartack.

- > Pull the ends of the cord through to the wrong side of the fabric (using a hand stitching-needle), knot or secure with stitches.

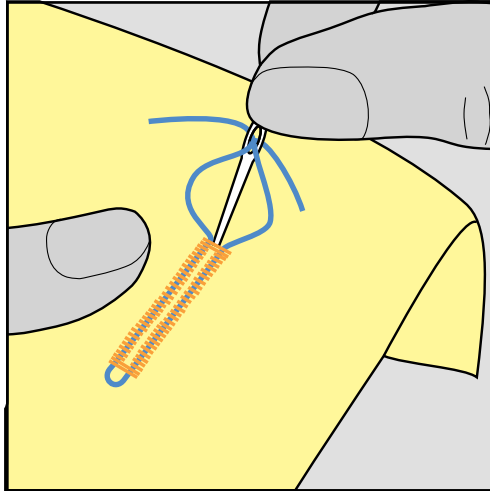

Using cord with the Buttonhole foot No. 3C (optional accessory)

Prerequisite:

- The Buttonhole foot No. 3 is attached and raised.
- > Insert the needle at the beginning of the buttonhole.
- > Hook the cord over the pin at the front of the buttonhole foot.

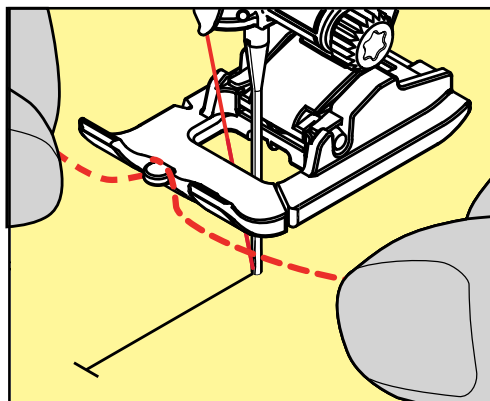

- > Pull both cords ends under the buttonhole foot to the back and place each a cord into a groove of the sole.

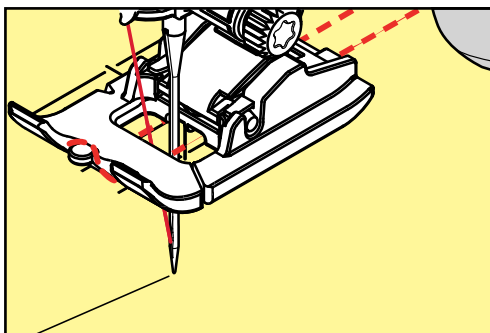

- > Lower the buttonhole foot.
- > Sew the buttonhole in the usual manner.
- > Pull the cord through the buttonhole until the loop disappears in the bartack.

- > Pull the ends of the cord through to the wrong side of the fabric using a hand stitching-needle and knot or secure with stitches.

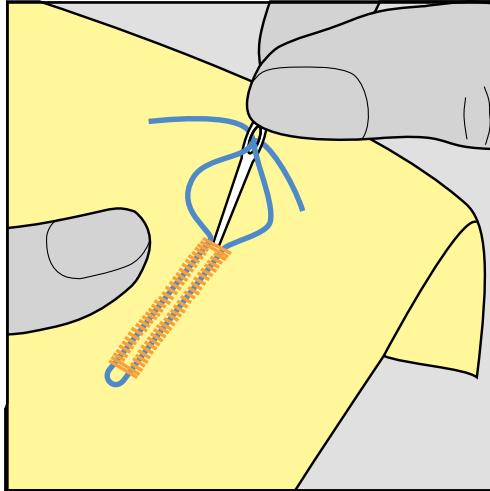

9.6 Sewing a test sample

Always sew a test sample of the buttonhole on the same fabric: It is recommended to use the same stabilizer and to select the same buttonhole. The test sample should also be sewn in the respective direction. By sewing a test sample the settings can be adjusted until the sewing result is satisfying.

When working with soft loosely woven materials or for buttonholes which are highly stressed, it is worth underlaying the buttonholes with the Straight stitch buttonhole No. 59. This is also recommended to reinforce buttonholes in leather, vinyl or felt.

Alterations of the balance when sewing a manual standard buttonhole as well as the keyhole and the round buttonhole affect both beads in the same way. With the manual keyhole or round buttonhole, the alterations affect both sides in the opposite way.

If the stitch counter function is used and alterations are made concerning the balance, the alterations affect both buttonhole beads differently.



- > Touch the icon «Buttonholes».
- > Select the buttonhole.
- > Select and attach the desired presser foot.
- > Place the fabric under the presser foot and lower the presser foot.
- > Press the foot control carefully and start sewing. Guide the fabric slightly.
- > Check the balance while sewing and adjust if necessary.
- > Check the test sample and make further amendments if necessary.

9.7 Determining the buttonhole slit width

The width of the buttonhole slit can be adjusted between 0.1 – 2.0 mm before sewing.



- > Touch the icon «Buttonholes».
- > Select the buttonhole.



- > Touch the icon «i»-Dialog.

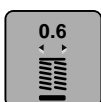

- > Touch the icon «Buttonhole slit width».
- > Turn the «Upper Multifunctional knob» or the «Lower Multifunctional knob» to adjust the buttonhole slit width as desired.

9.8 Determining the buttonhole length via the Buttonhole foot with slide No. 3A



The button can be placed in the yellow circle in the left section of the display. The yellow circle can be enlarged or downsized by turning the «Upper/Lower Multifunction knobs» and the diameter of the button can be determined in this way.

Additionally to the diameter of the button, 2 mm are added automatically for the buttonhole length. If the diameter of the button is 14 mm, the buttonhole length is calculated 16 mm.

Prerequisite:

- The Buttonhole foot with slide No. 3A is attached.



- > Touch the icon «Buttonholes».
- > Select the buttonhole.



- > Touch the icon «i»-Dialog.

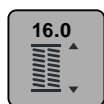

- > Touch the icon «Adjust the buttonhole length».
- > Turn the «Upper Multifunctional knob» or the «Lower Multifunctional knob» to adjust the buttonhole length.

9.9 Determining the buttonhole length with Buttonhole foot No. 3C (optional accessory)

With the Buttonhole foot No. 3C (optional accessory) the buttonhole length must be determined via the stitch counter function. The stitch counter function is suitable for all types of buttonholes. The left buttonhole bead is sewn forward, the right buttonhole bead is sewn in reverse. If alterations of the balance are made, the stitch counter function has to be saved for every buttonhole separately.

Prerequisite:

- The Buttonhole foot No. 3C (optional accessory) is attached.



- > Touch the icon «Buttonholes».
- > Select the buttonhole.



- > Touch the icon «i»-Dialog.



- > Touch the icon «Program the length with the stitch counter».
- > Sew the desired buttonhole length.
- > Stop the machine.

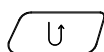

- > Push the button «Quick reverse» so that the machine sews the lower bartack and the second bead in reverse.
- > Stop the machine at the height of the first stitch.
- > Push the button «Quick Reverse» so that the machine sews the upper bartack and the securing stitches.
 - The length of the buttonhole remains saved and every subsequent buttonhole is sewn identically until the machine is switched off.

9.10 Sewing a buttonhole automatically



The lens on the Buttonhole foot with slide No. 3A automatically registers the length of the buttonhole. The buttonhole will be exactly duplicated and the machine switches to the next step automatically when the maximum length is reached. The Buttonhole foot with slide No. 3A is suitable for buttonholes at a length of 4 – 31 mm, depending on the buttonhole type. The Buttonhole foot with slide No. 3A must lie flat on the fabric so that the length can be measured accurately. The auto function ensures that each buttonhole will be exactly the same length as the previous one.

Prerequisite:

- The Buttonhole foot No. 3A is attached.



- > Touch the icon «Buttonholes».
- > Select the buttonhole No. 51 – 53 or 54, 56, 57 or No. 69.
- > Sew the desired buttonhole length.

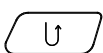

- > Push the button «Quick reverse» to program the length.



- > Push the button «Start/Stop» or the foot control.
 - The machine finishes the buttonhole automatically. All subsequent buttonholes are sewn at the same length.

9.11 Programming the Heirloom buttonhole

Prerequisite:

- The Buttonhole foot with slide No. 3A is attached.



- > Touch the icon «Buttonholes».
- > Select the Buttonhole No. 63.
- > Sew the desired buttonhole length.

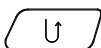

- > Push the button «Quick reverse» to program the length.
 - The machine finishes the buttonhole automatically. All subsequent buttonholes are sewn at the same length.

9.12 Sewing the manual 7-step buttonhole with the Buttonhole foot No. 3C (optional accessory)

The length of the buttonhole is determined manually when sewing. Bartack, eye and securing stitches are preprogrammed. The individual steps can also be selected by scrolling using the arrow icons or by touching the button «Quick Reverse».

Prerequisite:

- The Buttonhole foot No. 3C (optional accessory) is attached.



- > Touch the icon «Buttonholes».
- > Select the Buttonhole No. 51.



- > Touch the icon «i»-Dialog.



- > Touch the icon «Adjust the length manually».
 - Step 1 the display is activated for the buttonhole start.
- > Sew the desired buttonhole length.
 - Step 2 is activated.



- > Stop the machine at the desired length of the bead or at the end of the length marking.
- > Touch the icon «Scroll down» so that step 3 appears.
 - The machine sews straight stitches in reverse.
- > Stop at the height of the first stitch at the start of the buttonhole.

- > Touch the icon «Scroll down» so that step 4 appears.
 - The machine sews the upper bartack and stops automatically.
- > Touch the icon «Scroll down» so that step 5 appears.
 - The machine sews the second bead.
- > Stop the machine at the height of the first bead.
- > Touch the icon «Scroll down» so that step 6 appears.
 - The machine sews the bottom bartack and stops automatically.
- > Touch the icon «Scroll down» so that step 7 appears.
 - The machine secures and stops automatically.

9.13 Sewing the manual 5-step buttonhole with the Buttonhole foot No. 3C (optional accessory)

The length of the buttonhole is determined manually when sewing. Bartack, eye and securing stitches are preprogrammed. The individual steps can also be selected by scrolling using the arrow icons or by touching the button «Quick Reverse».

Prerequisite:

- The Buttonhole foot No. 3C (optional accessory) is attached.



- > Touch the icon «Buttonholes».
- > Select the Buttonhole No. 54.



- > Touch the icon «i»-Dialog.



- > Touch the icon «Adjust the length manually».
 - Step 1 the display is activated for the buttonhole start.
- > Sew the desired buttonhole length.
 - Step 2 is activated.



- > Stop sewing at the desired length of the bead or at the marking.
- > Touch the icon «Scroll down» so that step 3 appears.
 - The machine sews the eye or the keyhole and stops automatically.
- > Touch the icon «Scroll down» so that step 4 appears.
 - The machine sews the second bead in reverse.
- > Stop the machine at the first stitch where the buttonhole starts.



- > Touch the icon «Scroll down» so that step 5 appears.
 - The machine sews the upper bartack and secures automatically.

9.14 Cutting the buttonhole open with the seam ripper

- > Place a pin in each end of the buttonhole to avoid accidental cutting into ends of buttonhole.
- > Cut the buttonhole from both ends to the middle.

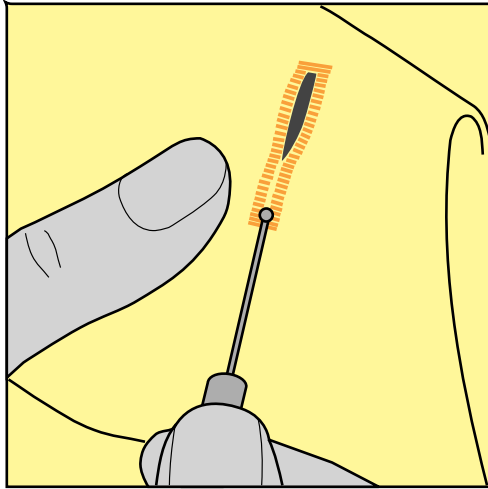

9.15 Cutting open buttonholes with the buttonhole cutter (optional accessory)

- > Place the fabric on an appropriate piece of wood.

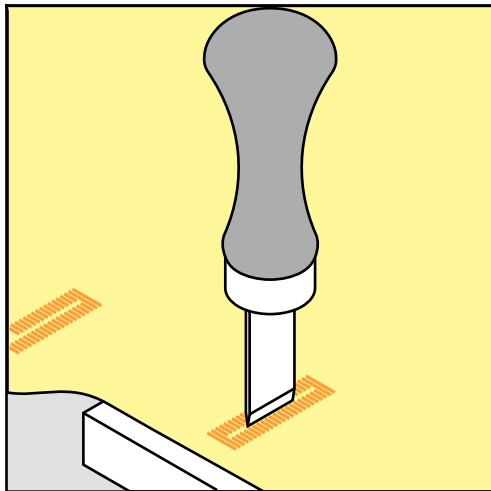

- > Position the cutter in the center of the buttonhole.
- > Press down on the cutter with your hand.

9.16 Sewing on buttons

With the Button sew-on program, buttons with 2 or 4 holes, snap buttons or snap fasteners can be sewn on.

Recommended sewing program: Button sewing-on program No. 60

Recommended presser foot : Button sew-on foot No. 18

Alternative presser feet:

- Reverse pattern foot No. 1 or 1C
- Darning foot No. 9
- Reverse pattern foot No. 34 or 34C

Adjusting the thread shank

For buttons on thicker fabrics, increase the thread shank = the distance between the button and the fabric.

Buttons sewn on thin fabrics or buttons for decorative purposes only are stitched without a «thread shank».

NOTICE! The adjustment of the thread shank is only possible when using the Button sew-on foot No. 18.

- > Loosen the screw on the back of the presser foot.
- > Push the bar upwards according to the thickness of the fabric.
- > Tighten the screw.

Sewing on buttons

Prerequisite:

- The shank length is adjusted according the fabric thickness.
- The Button sew-on foot No. 18 or an alternative presser foot is attached.
- The attached presser foot has been selected in the user interface.
- The feed dog is lowered.



- > Touch the icon «Buttonholes».
- > Select the Button sew-on Program No. 60.
- > Turn the handwheel until the bobbin thread comes up.
- > **NOTICE! The Button sew-on program always starts above the left hole of the button.**
Position the button on the fabric. Place the button and the fabric beneath the needle so that the needle stitches into the left hole.
For buttons with 4 holes, sew the first front pair of holes first.
- > Lower the presser foot.
- > Perform the first stitches in the left hole via the handwheel.
- > Keep turning the handwheel until the needle changes to the right hole.
Make sure that the needle meets the right hole. If necessary, adjust the stitch width by turning the upper Multifunction knob.
- > Hold the threads and push the foot control.
 - The machine sews on the button and stops automatically.
- > For increased stability, sew the Button sew-on program again.
- > Cut the threads with the machine. Alternatively, pull the sewing projects from under the sewing machine and trim the threads by hand. Pull the upper thread to the wrong side of the fabric and knot it with the bobbin thread.

9.17 Sewing eyelets



For increased stability sew the eyelet twice.

Prerequisite:

- The Reverse pattern foot No. 1C or the Open embroidery foot No. 20C is attached.







- > Touch the icon «Buttonholes».
- > Select the Eyelet Program No. 61 or No. 62.
- > Turn the «Upper Multifunction knob» or the «Lower Multifunction knob» to alter the size of the eyelet.
- > Sew the Eyelet Program.
 - The machine stops automatically at the end of the Eyelet Program.
- > Use an awl, punch pliers or a hole punch to open the eyelet.

10 Quilting

10.1 Overview Quilt Stitches



Stitch pattern	Number of stitch pattern	Name	Description
	1324	Quilting, Securing Program	To secure at the sewing start and sewing end with short stitches forward.
	1325	Quilting straight stitch	Straight stitch at 3 mm stitch length.
	1327	Stippling stitch	Imitation of stipple quilting.
	1328	Handlook quilt stitch	Imitation of handlook quilt stitch with monofilament.
	1329	Blanket stitch	For appliqué and sewing on ribbons.
	1330	Double blanket stitch	For appliqué and sewing on ribbons.
	1331	Blindstitch narrow	To sew blind stitches.
	1332	Feather stitch	For "Crazy Patchwork" and embellishing.
	1333	Feather stitch variations 1333, 1334, 1336	For "Crazy Patchwork" and embellishing.
	1339	Decorative Quilt stitch/ Handlook stitch variations 1339, 1355 – 1359, 1396	For "Crazy Patchwork" and embellishing.

Stitch pattern	Number of stitch pattern	Name	Description
 6"/inch 2,4 cm	1346	Quilt stitch/Handlook stitch variations 1346, 1347, 1348	Imitation of stipple quilting, to use with monofilament.
	1352	Blanket stitch dual	To edgestitch between two appliqués, "Crazy Patchwork".
	1353	Double blanket stitch dual	To edgestitch between two appliqués, "Crazy Patchwork".
	1354	Satin stitch	For appliqué.

10.2 Quilting, Securing Program

Prerequisite:

- The Reverse pattern foot No.1C is attached.



- > Touch the icon «Quilt stitches».
- > Select Quilt stitch pattern No. 1324.
- > Press the foot control.
 - The machine sews 6 stitches forward automatically when sewing is started.
- > Sew the seam in the desired length.

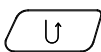

- > Push the button «Quick reverse».
 - The machine sews 6 stitches forward automatically and stops automatically at the end of the Securing Program.

10.3 Sewing handlook quilt stitches

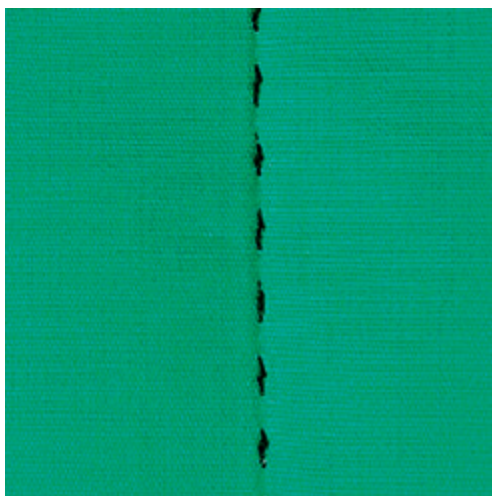

Hand-look quilt stitches are suitable for all fabrics and sewing projects which should look as if sewn by hand. It is recommended to use a monofilament thread as upper thread and an embroidery thread as bobbin thread. The sewing speed should be moderate to prevent the monofilament from breaking. If required, the upper thread tension and the balance can be adjusted to the sewing project and the desired quilt stitch.

Prerequisite:

- The Reverse pattern foot No.1C is attached.



- > Touch the icon «Quilt stitches».
- > Select Handlook quilt stitches No. 1328, 1346, 1347 or 1348.
- > If required, adjust the upper thread tension and the balance to the sewing project and the desired quilt stitch.
- > Press the foot control or the button «Start/Stop» to start the machine.

10.4 Guiding the quilt work freely



Quilt gloves with rubber fingertips (optional accessory) will help when guiding the fabric.

It is recommended to use the slide-on table and the Free Hand System. With free-motion quilting, it is of advantage to quilt from the center outwards and to guide the fabric using smooth, round movements to form the design of your choice. Free-motion quilting and darning are based on the same free-motion principles.

With stipple quilting, entire surfaces of the fabric are filled with quilt stitches. The single lines of stitching are rounded and never cross one another.

Prerequisite:

- The top layer, the batting and the backing are pinned together or basted.
- The feed dog is lowered.
- The Darning foot No. 9 (optional accessory) is attached.



- > Touch the icon «Practical stitches».
- > Select the Straight stitch No. 1.
- > Adjust the upper thread tension and the balance to the sewing project if necessary.
- > Press the foot control or the button «Start/Stop» to start the machine.
- > Hold both hands close to the presser foot like an embroidery hoop to guide the fabric.
- > If the thread is lying on top of the fabric, slow down the movement.
- > If there are knots on the wrong side of the fabric, move the fabric more quickly.

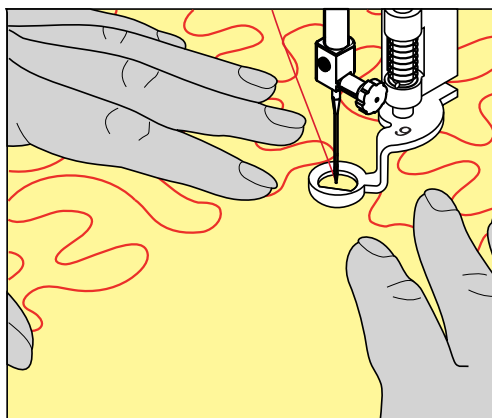

11 BERNINA Stitch Regulator (BSR)

The BERNINA Stitch regulator equalizes the stitch length which results of the free movement of the fabric while free-motion sewing - a sewing technique which grows more and more popular. When free-motion sewing with the BSR presser foot, every stitch is equally long and the stitch formation is perfectly regular.

As soon as the BSR presser foot is attached and the feed dog is lowered, the selection menu of the desired mode appears in the display of the machine. The BSR presser foot can be used with sewing straight stitch as well as zig zag.

The BSR presser foot reacts on the movement of the fabric and therefore controls the speed of the machine up to the highest possible speed. It can be said: The faster the movement of the material, the higher the speed of the machine.

If the fabric is moved too quickly, an acoustic signal sounds. The beeper can be activated or deactivated in the «BSR» display. The sound of the beeper can also be activated or deactivated in the Setup Program.

11.1 BSR mode 1

The BSR function can be controlled via the foot control or with the button «Start/Stop». Start the BSR mode. At the BSR presser foot a red light is on. By moving the fabric the machine accelerates. If the fabric isn't moved, securing in place is possible without pressing an additional button. When working via the foot control or when using the button «Start/Stop», the BSR mode doesn't stop automatically.

11.2 BSR mode 2

The BSR function can be controlled via the foot control or the button «Start/Stop». The machine starts only when the foot control or the button «Start/Stop» is pressed and the fabric is moved simultaneously. Without moving the fabric, the BSR2 modus stops after about 7 seconds. The red light goes off (only when working with the button «Start/Stop»). When working via the foot control, the red light doesn't go off.

11.3 BSR function with Straight stitch No. 1

This function allows free-motion quilting with straight stitch and a pre-programmed stitch length up to 4 mm. The programmed stitch length is maintained within a certain speed, independent of the fabric movement.

11.4 BSR function with Zig zag No. 2

The zig zag can be used e.g. for thread painting. The set stitch length will **not** be maintained when sewing the zig zag stitch, but the BSR function simplifies the application.

11.5 Sewing preparations for quilting

Attach the BSR presser foot

NOTICE

The lens of the BSR presser foot is dirty

The machine doesn't recognize the BSR presser foot.

> Clean the lens with a soft, slightly damp cloth.

> Change the presser foot.

- > Insert the cable of the BSR foot into the connection (1).



- > Switch the machine on.
 - The BSR display opens and the BSR 1 mode is activated.

Changing the presser foot sole

NOTICE

The lens of the BSR presser foot is dirty

The machine doesn't recognize the BSR presser foot.

- > Clean the lens with a soft, slightly damp cloth.

The standard stitch length is 2 mm. When sewing small shapes and stippling it is recommended to shorten the stitch length to 1 – 1.5 mm.

- > Raise the needle.
- > Raise the BSR foot.
- > Switch the machine off and disconnect it from the power supply system.
- > Remove the BSR foot from the machine.
- > Press both push buttons at the BSR foot against each other.

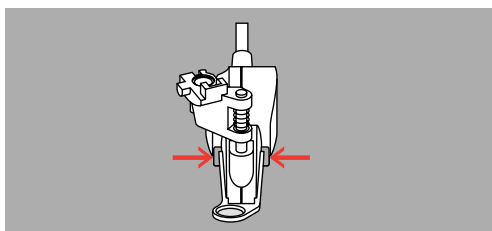

- > Pull the presser foot sole out of the guide downwards.
- > Insert the new presser foot sole into the guide and push upwards until it clicks into place.
- > Attach the BSR presser foot.

11.6 Using the BSR mode

The BSR function can be controlled via the foot control or the button «Start/Stop».

Starting via the foot control: The foot control needs to be pressed while quilting. The machine keeps running in the BSR1 mode until the foot control is released, even if the fabric isn't moved.

If quilting is stopped in the BSR2 mode, the machine sews another stitch depending on the needle position and stops with needle position up.



Prerequisite:

- The slide-on table is attached.
- The knee lifter of the Free Hand System is attached.

> Lower the feed dog.

> Select the desired BSR mode.



> Push the button «Start/Stop» or press the foot control to lower the presser foot.

> Push the button «Start/Stop» again or press the foot control again and keep pressed to start the BSR mode.

- At the BSR presser foot a red light is on.

> Move the fabric to control the speed of the machine in the BSR mode.



> Push the button «Start/Stop» again or release the foot control to stop the BSR mode.

- The BSR mode stops and the red light at the presser foot goes off.

> Touch the icon «BSR» (1) to deactivate the BSR mode and to quilt without automatic stitch length.



11.7 Securing

Securing in BSR1 mode with the button «Start/Stop»

Prerequisite:

- The BSR presser foot is attached and connected with the machine.
- The BSR display is opened and the BSR1 mode is activated.

> Lower the feed dog.

> Lower the presser foot.



> Push the button «Needle up/down» twice.

- The bobbin thread is brought up.

> Hold the upper and the bobbin thread.



> Push the button «Start/Stop».

- Start the BSR mode.

> Sew 5 – 6 securing stitches.



> Push the button «Start/Stop».

- The BSR mode stops.

> Cut the thread.

Securing in BSR2 mode

Prerequisite:

- The BSR presser foot is attached and connected with the machine.
- The BSR display is open and the BSR2 mode is activated.

- > Lower the presser foot.
- > Touch the icon «i»-Dialog.



- > Touch the icon «Securing».



- > Press the foot control or the button «Start/Stop».

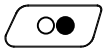

By moving the fabric some short securing stitches are sewn, then the programmed stitch length is activated and the securing function is deactivated automatically.



12 Attachment

12.1 Maintenance and cleaning

Cleaning the display

- > Clean the display in the switched off status with a soft slightly damp microfiber cloth.

Cleaning the feed dog

Remove the thread remnants under the stitch plate regularly.



Electronically driven components

Risk of injury near the needle and the hook.

- > Raise the presser foot.
- > Switch the machine off and disconnect it from the power supply system.

- > Remove the presser foot and the needle.
- > Lower feed dog.



- > Remove the stitch plate.
- > Clean the feed dog with the brush.

Cleaning the hook



Electronically driven components

Risk of injury near the needle and the hook.

- > Switch the machine off and disconnect it from the power supply system.

- > Open the bobbin cover.
- > Remove the bobbin case.
- > Push the fastening bracket to the left.



- > Flap down the fastening bracket along with the black hook race cover.
- > Remove the hook.



- > Clean the hook race area with the brush; never use a sharp instrument.
- > Hold the hook at the pin in the center with two fingers.
- > Lead the hook, lower edge ahead, angular top-down behind the hook race cover.
- > Position the hook with the two lugs meeting the openings in the hook, the colored mark on the hook driver should be visible through the hole in the hook.
- > Insert the hook.
 - The hook is magnetic and therefore fastened to the correct position.
- > Close the hook race cover and the fastening bracket until the release bracket engages.
- > As a check, turn the handwheel.
- > Insert the bobbin case.

Lubricating the hook



CAUTION

Electronically driven components

Risk of injury near the needle and the hook.

- > Switch the machine off and disconnect it from the power supply system.

NOTICE

Lubricating the hook

Too much oil can pollute the fabric and the thread.

- > Always sew a test sample first.
- > Remove the bobbin case.
- > Push the fastening bracket to the left.



- > Flap down the fastening bracket along with the black hook race cover.

- > Remove the hook.

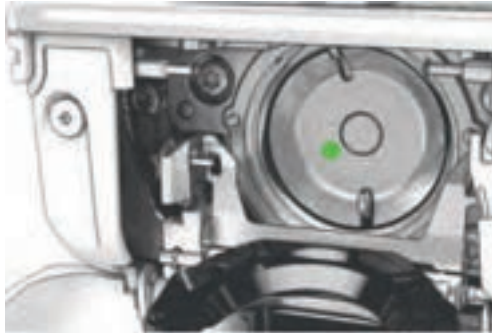

- > Give one drop of BERNINA oil down in the hook race.





- > Give one drop of oil in each of the two oil depots so that the felts are damp and make sure that the red-marked surface of the hook sleeve remains free of oil.



- > Hold the hook at the pin in the center with two fingers.
- > Lead the hook, lower edge ahead, angular top-down behind the hook race cover.
- > Position the hook with the two lugs meeting the openings in the hook, the colored mark on the hook driver should be visible through the hole in the hook.
- > Insert the hook.
 - The hook is magnetic and therefore fastened to the correct position.
- > Close the hook race cover and the fastening bracket until the release bracket engages.
- > As a check, turn the handwheel.
- > Insert the bobbin case.







12.2 Troubleshooting

Failure	Cause	Repair
Uneven stitch formation	Upper thread too tight or too loose.	> Adjust the upper thread tension.
	Needle blunt or bent.	> Replace the needle, make sure that a new BERNINA quality needle is used.
	Poor quality needle.	> Use a new BERNINA quality needle.
	Poor quality thread.	> Use quality thread.
	Incorrect needle/thread combination.	> Match the needle with the thread size.
	Incorrectly threaded.	> Rethread.
	The fabric has been pulled.	> Feed the fabric evenly.
Uneven stitch formation	Incorrect bobbin case is used.	> Use the supplied bobbin case with triangles.
		
Skipped stitches	Incorrect needle.	> Use the needle system 130/705H.
	Needle blunt or bent.	> Replace the needle.
	Poor quality needle.	> Use a new BERNINA quality needle.
	The needle is incorrectly inserted.	> Insert the needle with the flat side to the back as far up as it will go into the needle holder and tighten the screw.
	Incorrect needle point.	> Match the needle point to the texture of the material.
Faulty stitching	Thread remnants between the thread tension discs.	> Fold a piece of thin material and slide the folded edge (not the raw edges) between the thread tension discs.
	Incorrectly threaded.	> Rethread.
	Thread remnants below the bobbin case spring.	> Remove the thread remnants under the spring.

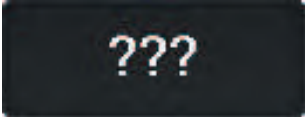
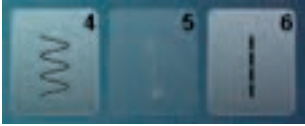
Failure	Cause	Repair
Upper thread breaks	Incorrect needle/thread combination.	> Match the needle with the thread size.
	Upper thread is too tight.	> Reduce the upper thread tension.
	Incorrectly threaded.	> Rethread.
	Poor quality thread.	> Use quality thread.
	The stitch plate or the hook tip is damaged.	> Contact the nearest specialized BERNINA dealer to have the damages repaired. > Replace the stitch plate.
	The thread is caught in the area of the thread take-up lever.	> Remove the screw (1) on the headframe with the angular Torx wrench. > Pull the headframe at the bottom slightly forward. > Flip the headframe upwards a bit and remove it. > Remove the thread remnants. > Attach the headframe and tighten the screw.
		
Lower thread breaks	The bobbin case is damaged.	> Replace the bobbin case.
	The stitch hole in the stitch plate is damaged.	> Contact the nearest specialized BERNINA dealer to have the damages repaired. > Replace the stitch plate.
	Needle blunt or bent.	> Replace the needle.
Needle breaks	The needle is incorrectly inserted.	> Insert the needle with the flat side to the back as far up as it will go into the needle holder and tighten the screw.
	The fabric has been pulled.	> Feed the fabric evenly.
	Thick fabric has been pushed.	> Use the appropriate presser foot, e.g. Jeans foot No. 8 for thick material. > Use the height compensating tool when sewing over a thick seam.
	Knotted thread.	> Use quality thread.
Display is inactive	Incorrect calibrating data.	> Switch the machine off. > Switch the machine on and at the same time push button «Needle left/right» and keep it pressed. > Calibrate the display again.
	The eco-function is active.	> Touch the icon «eco».

Failure	Cause	Repair
Stitch width not adjustable	The selected needle and stitch plate cannot be used in combination.	<ul style="list-style-type: none"> > Replace the needle. > Replace the stitch plate.
Speed too low	Unfavorable room temperature.	> Place the machine in a warm room one hour before use.
	Settings in the Setup Program.	<ul style="list-style-type: none"> > Adjust the sewing speed in the Setup Program. > Adjust the slide.
The machine doesn't start	Unfavorable room temperature.	<ul style="list-style-type: none"> > Place the machine in a warm room one hour before use. > Connect the machine and switch it on.
	The machine is damaged.	> Contact the specialized BERNINA dealer.
The light of the button «Start-/Stop» doesn't light up	Light is defect.	> Contact the specialized BERNINA dealer.
Neither the sewing light nor the light on the free arm lights up	Settings in the Setup Program.	> Activate it in the Setup Program.
	The sewing light is defect.	> Contact the specialized BERNINA dealer.
Upper thread indicator doesn't react	Settings in the Setup Program.	> Activate it in the Setup Program.
	The upper thread indicator is defect.	> Contact the specialized BERNINA dealer.
Error during software update	USB stick is not recognized.	> Use a BERNINA USB stick.
	The update process is blocked and the hourglass on the display is inactive.	<ul style="list-style-type: none"> > Remove the USB stick. > Switch the machine off. > Switch the machine on. > Follow the instruction on the display.
	Date of the software update cannot be found.	<ul style="list-style-type: none"> > Unzip the update data. > Save data of the software update directly on the data medium and not in a file on the USB stick.

12.3 Error messages

Message on the display	Cause	Repair
	Stitch number unknown.	> Check the entry and enter the new number.
	Selection of the stitch pattern not possible in the combi mode.	> Combine other stitches.
	The feed dog is not lowered.	> Push the button «Feed dog up/down» to lower the feed dog.
	The selected needle and stitch plate cannot be used in combination.	> Replace the needle. > Replace the stitch plate.
	The needle is not at its top end.	> Adjust the needle position via the handwheel.
	The upper thread is used up.	> Rethread.
	The upper thread has broken.	> Rethread.
	The main motor isn't running.	> Turn the handwheel clockwise until the needle is at its top position. > Remove the stitch plate. > Remove the thread remnants. > Clean the hook. > Remove the hook and make sure that there are no pieces of broken needle points on the magnetic back of the hook.

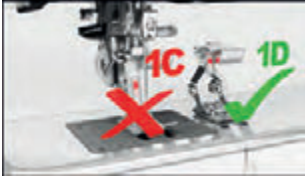
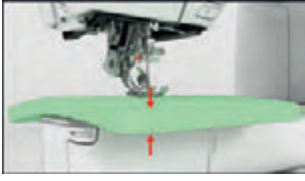
Message on the display	Cause	Repair
	Incorrect presser foot for the BERNINA Dual Feed.	> Attach a presser foot with the designation «D».
	The fabric under the presser foot is too thick.	> Reduce the fabric thickness.
Too less free capacity on the BERNINA USB stick (optional accessory).	Not enough free capacity on the BERNINA USB stick (optional accessory).	> Make sure that the BERNINA USB stick (optional accessory) is used. > Delete data from the BERNINA USB stick (optional accessory).
No personal data on the BERNINA USB stick (optional accessory).	No personal data for recovery available on the BERNINA USB stick (optional accessory).	> Make sure that the data and settings have been saved on the BERNINA USB stick (optional accessory).
The recovery of personal data has failed.	The software update has been successful but the personal data couldn't be recovered.	> Make sure that the data and settings have been saved on the BERNINA USB stick (optional accessory). > Transfer saved data to the machine.
No BERNINA USB stick is inserted. Make sure that during the complete automatic update always the same BERNINA USB stick remains inserted.	The BERNINA USB stick (optional accessory) is not inserted.	> Use a BERNINA USB stick (optional accessory) providing enough free capacity.
The update of the software has failed.	The latest software version cannot be found on the USB stick.	> Make sure that the compressed zip file has been unzipped for the software update. > Check whether the data for the software update are saved directly on the data medium and not in a file on the USB stick. > Update the software.

Message on the display	Cause	Repair
 <p>The screenshot shows a maintenance instruction screen. The top part has the title 'Lubricating the Machine' and a sub-note 'It is important to lubricate the machine regularly.' Below this is a photo of a hand using a small brush to apply oil to the machine's internal mechanism. A large red '1X' is overlaid on the photo. Below the photo, it says 'Step 1:'.</p>	<p>The machine needs cleaning/ lubricating.</p>	<ul style="list-style-type: none"> > Clean the machine. > Lubricate the machine. <p>Important information on lubricating:</p> <ul style="list-style-type: none"> > Too much oil can pollute the fabric and the thread. > After lubricating, always embroider on a test piece.
<p>The automatic thread cutter (at the thread catcher) needs cleaning.</p>	<p>The automatic thread cutter needs cleaning. The message appears every time when the machine is started as soon as 1000 cutting cycles have been carried out.</p>	<ul style="list-style-type: none"> > Touch the icon «Confirm». <ul style="list-style-type: none"> – The machine calls up the function «Clean the thread catcher». > Clean the thread catcher according to the instructions on the display. <ul style="list-style-type: none"> – The counter for the cutting cycles is reset.
<p>It is time for the regular maintenance. Please contact your specialized BERNINA dealer to make an appointment.</p>	<p>The machine needs maintenance. The message appears after the programmed service interval has expired.</p> <p>Important information: Having your machine cleaned and serviced properly at the appropriate times ensures its proper functioning and a long service life. Ignoring the terms can affect the operating life and restrict the guaranteeing. The cost allocation for maintenance work is regulated nationally. Consult your specialised dealer or your servicing shop for more details.</p>	<ul style="list-style-type: none"> > Contact the specialized BERNINA dealer. > Delete the message temporarily by touching the icon «ESC». <p>Having cleared the message three times, the message will appear as recently as the next service interval has been completed.</p>

12.4 Storage and disposal

Storing the machine

It is recommended to store the machine in the original packaging. If the machine is stored in a cold room, place it in a warm room one hour before use.

- > Switch the machine off and disconnect it from the power supply system.
- > Don't store the machine outdoor.
- > Protect the machine against climatic influences.

Dispose of the machine

- > Clean the machine.
- > Sort the components by their materials and dispose of them according to the local laws and regulations.

12.5 Technical data

Term	Value	Unit
Maximum fabric thickness	12,5 (0,49)	mm (in)
Sewing light	30	LED
Maximum speed	1000	Stitches per minute
Measurements without the spool pin (W × H × D)	522 × 358 × 214 (20,55 × 14,09 × 8,43)	mm (in)
Weight	14 (30,86)	kg (lb)
Energy consumption	140	W
Input voltage	100 – 240	V
Protection class (Electrical engineering)	II	

13 Overview stitch patterns

13.1 Overview Stitch patterns

Practical stitches

1	2	3	4	5	6	7	8	9	10	11
12	13	14	15	16	17	18	19	20	22	23
24	25	26	29	30	32	33				

Buttonholes





















51	52	53	54	56	57	59	63	69	60	61
62										

Decorative stitches





























Natural stitches

101	102	103	104	107	108	110	111	112	113	114
115	117	119	120	121	122	123	124	125	128	129
134	136	137	143	146	147	152				





































Cross stitches

301	302	303	304	305	306	307	308	309	311	314
										
323	324	325	326	371	372	373	374	375	376	
										

Satin stitches

401	402	405	406	407	408	412	413	414	415	416
										
417	419	422	424	425	426	428	429	430	431	437
										
439	450	457	461	464	471	473				
										

Ornamental stitches

601	602	603	604	605	606	607	610	611	612	613
										
614	615	616	627	630	631	633	635	639	640	641
										
642	643	644	645	648	649	651	653	655	656	661
										
676	677	684	685							
										

Heirloom stitches

701	702	705	706	708	709	710	711	712	713	714
717	719	720	721	722	723	724	725	726	728	730
731	732	738	740	741	742	743	746	747	748	749
750	751	772	775	777	779					

Novelty

903	904	906	907	908	911	913	914	916	919	920
921	925	929	930	934	935	938	939	940	942	947

Quilt stitches

1324	1325	1327	1328	1329	1330	1331	1332	1333	1334	1336
1339	1346	1347	1348	1352	1353	1354	1355	1356	1357	1358
1359	1396									

Index

A

Activating the audio signals	54
Activating the upper thread indicator	54
Adjusting the brightness of the display	55
Adjusting the presser foot pressure	39
Adjusting the presser position via the knee lifter of the Free Hand System	37
Adjusting the sewing light	55
Adjusting the upper thread tension	50
Alphabets	102
Attaching the knee lifter	33

B

Back to default setting	56
BERNINA Dual Feed	65
Buttonholes	104

C

Calibrating the Buttonhole foot No. 3A	57
Calibrating the display	56
Calling up Help	63
Calling up the Creative Consultant	63
Calling up the Tutorial	63
Changing the needle	39
Changing the presser foot	38
Changing the stitch plate	42
Checking the firmware version	60
Child safety feature	63
Cleaning the feed dog	125
Cleaning the hook	125
Cleaning the thread catcher	59
Combi mode	70
Connecting the foot control	31
Cord	107

D

Decorative stitches	97
Dispose of the machine	134

E

Environmental Protection	13
Error messages	131

I

Introduction	14
--------------	----

K

Key to signs	15
--------------	----

L

Lubricating the hook	126
Lubricating the machine	60

M

Maintenance and cleaning	125
--------------------------	-----

N

Needle stop up/down (permanent)	41
Needle, Thread, Fabric	26
Needles, Threads	28

O

Overview Stitch patterns	135
--------------------------	-----

P

Pintucks	99
Placing the spool disc	35
Power save mode	63
Practical stitches	81
Programming the securing stitches	50

Q

Quilting	117
----------	-----

R

Raising/Lowering the needle	34
Registering details of the dealer	61
Regulating the speed	66

S

Safety instructions	11
Saving Service data	62
Selecting a language	55
Selecting a stitch pattern	64
Selecting personal settings	53



in partnership with

Mettler[®]

made to create **BERNINA**