



View this machine and more at:

<https://www.thesewingstudio.co.uk>



b05  
CRAFTER



b05  
ACADEMY

Quick Start Guide

bernette

SWISS DESIGN



# IMPORTANT SAFETY INSTRUCTIONS

Observe the following basic safety instructions when using your machine. Before using this machine, read instruction manual carefully.

## DANGER!

To reduce the risk of electrical shock:

- Never leave the machine unattended as long as it is plugged in.
- Always unplug the machine from the electrical outlet immediately after using.

Protection against LED radiation:

- Do not view the LED light directly with optical instruments (e.g. magnifier). The LED light corresponds with protection class 1M.
- When the LED light is damaged or defective, contact your bernette specialist dealer.

## WARNING

To reduce the risk of burns, fire, electric shock or injury to persons:

- To operate the machine always use the supplied power cable. USA and Canada only: Do not connect power plug NEMA 1-15 to circuits exceeding 150 volt-to-ground.
- Use this machine only for purposes as described in this manual.
- Only use the machine in dry rooms.
- Do not use the machine in a damp condition or in a damp environment.
- Do not use this machine as a toy. Close attention is necessary when this machine is used by or near children.
- The machine can be used by children older than 8 or by people with reduced physical, sensory or mental capabilities or if there is a lack of experience and knowledge how to operate the machine as long as they are supervised or have been given instruction concerning the responsible use of the appliance and are aware of the involved risks.
- Children are not allowed to play with this machine.
- Cleaning and maintenance work must not be carried out by children unless they are supervised.
- Never operate this machine if it has a damaged cord or plug, if it is not working properly, if it has been dropped or damaged, or dropped into water. Contact the nearest authorized bernette dealer to arrange further details.
- Only use accessory recommended by the manufacturer.
- Don't use this machine when the ventilation openings are blocked. Keep the ventilation openings and the foot control free from the accumulation of lint, dust and loose cloth.
- Never insert any objects into any openings of the machine.

- Do not place any objects on the foot control.
- Always use the machine with a foot control of these types:
  - for b05 CRAFTER: FC-2902D, FC-1902A
  - for b05 ACADEMY: KD-2902, KD-1902
- Do not operate the machine where aerosol products (sprays) or oxygen are being used.
- Keep fingers away from all moving parts. Special care is required around the needle.
- Neither pull nor push the fabric while sewing. This can cause needle breakage.
- When making any adjustments in the needle area – such as such as threading the needle, changing the needle, threading the hook or changing the presser foot – turn power switch to «0».
- Do not use bent needles.
- Always use the original bernette stitch plate. The wrong stitch plate can cause needle breakage.
- To disconnect, turn power switch to «0» and then remove the plug from the outlet. Do not unplug by pulling the cord, instead grasp the plug to pull it from the outlet.
- Always disconnect the power plug from the electrical outlet when the covers are removed or opened, when the machine is lubricated or during any other maintenance adjustments mentioned in the instruction manual.
- This machine is provided with double insulation (except USA, Canada and Japan). Use only identical replacement parts. See instructions for Servicing of double-insulated products.
- The sound pressure level is lower than 80 dB(A) under normal conditions.

# Important information

## Availability of the instruction manual

The quick start guide is part of the machine.

- Keep the quick start guide of the machine in a suitable place near the machine and have it ready for reference.
- A detailed instruction manual can be downloaded from [www.mybernette.com](http://www.mybernette.com).
- When passing on the machine to a third party, enclose the quick start guide of the machine.

## Proper use

Your bernette machine is conceived and designed for private household use. It answers the purpose to quilt fabrics as it is described in this instruction manual. Any other use is not considered appropriate. BERNINA assumes no liability concerning consequences resulting from an inappropriate usage.

## Maintenance of double-insulated products

In a double-insulated product two systems of insulation are provided instead of grounding. No grounding means is provided on a doubleinsulated product, nor should a means for grounding be added to the product. Servicing a double-insulated product requires extreme care and knowledge of the system and should be done only by qualified service personnel. Replacement parts for a double-insulated product must be identical to the original parts in the product. A double-insulated product is marked with the words: "double insulation" or "double-insulated".



The symbol may also be marked on the product.

## Protection of the environment



BERNINA is committed to the protection of the environment. We strive to minimize the environmental impact of our products by continuously improving product design and our technology of manufacturing.

The machine is labeled with the symbol of the crossed-out wastebasket. This means that the machine must not be disposed of with the household waste when the machine is no longer needed. Improper disposal can result in dangerous substances getting into the groundwater and thus into our food chain, damaging our health.

The machine must be returned free of charge to a nearby collection point for waste electrical and electronic equipment or to a collection point for the reuse of the machine. Information on the collection points can be obtained from your local administration. When purchasing a new machine, the dealer is obliged to take back the old machine free of charge and dispose of it properly.

If the machine contains personal data, you are responsible for deleting the data yourself before returning the machine.

# Content

Overview of the machine .....	1
Getting started .....	2
Bobbin winding .....	2
Threading the bobbin thread .....	3
Threading the upper thread .....	5
Changing presser foot .....	7
Changing the needle .....	8
Selecting stitches .....	9
Maintenance.....	13
Troubleshooting.....	16
Overview of the stitches.....	19

# Overview of the machine

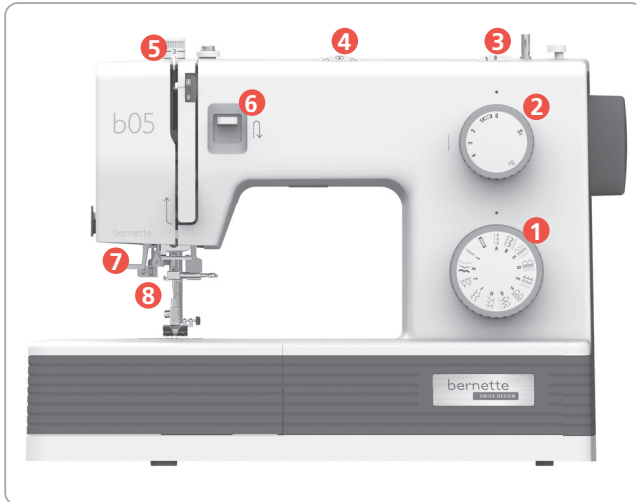

- 1 Stitch selection dial
- 2 Stitch length dial
- 3 Stitch width dial
- 4 Needle position dial
- 5 Presser foot pressure dial
- 6 Reverse sewing lever
- 7 Needle threader
- 8 Buttonhole lever



- 9 Hand wheel
- 10 Balance dial
- 11 Power switch with speed limitation (for b05 ACADEMY)  
Power switch (for b05 CRAFTER)
- 12 Power/foot control connection



# Getting started

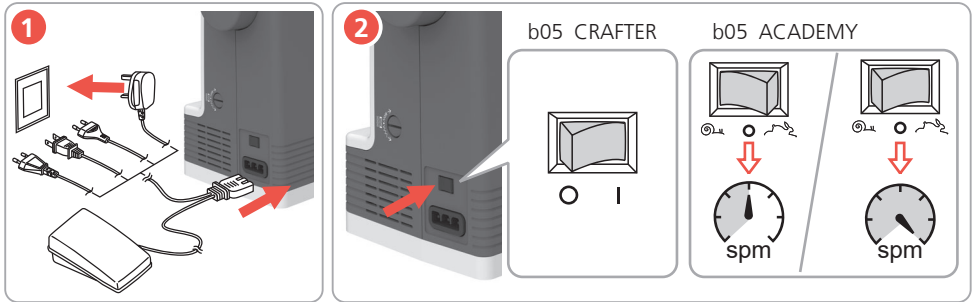

# Bobbin winding

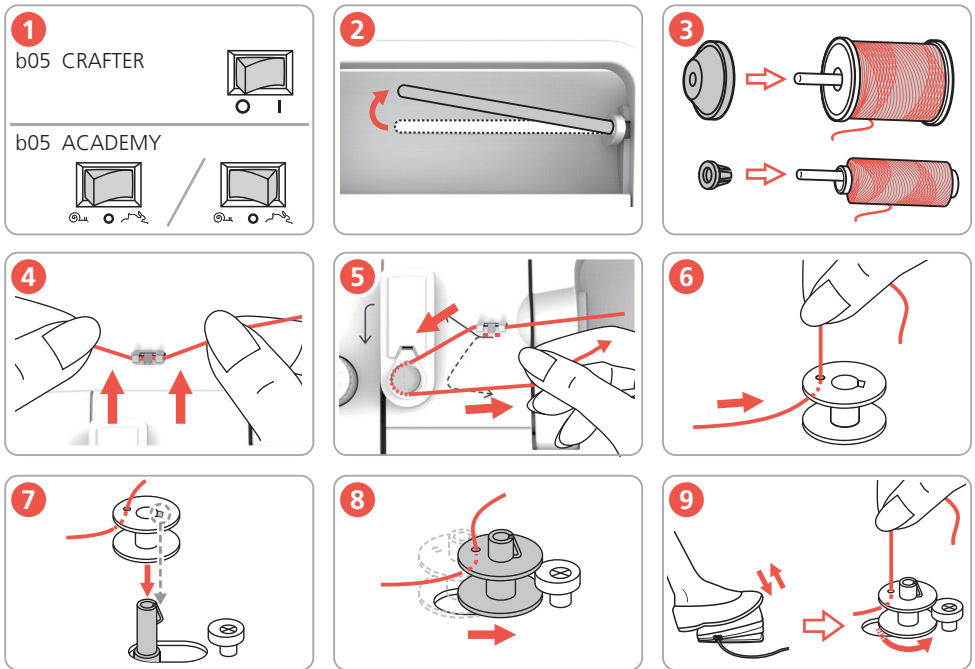
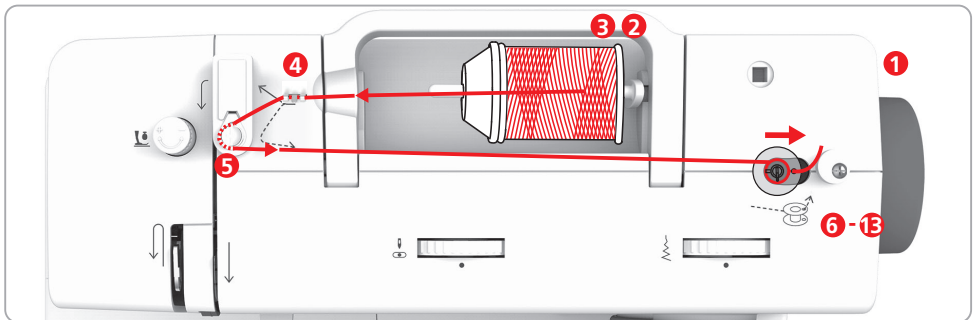

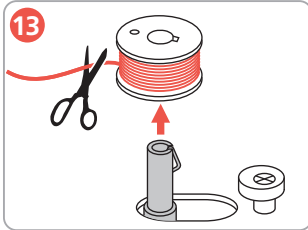
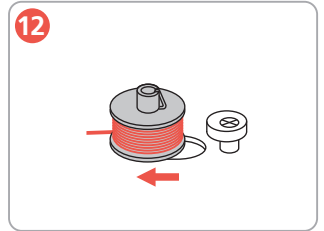
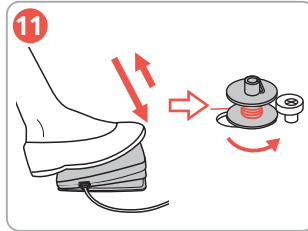
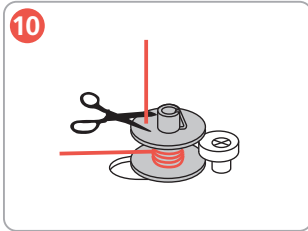

## Threading the bobbin thread

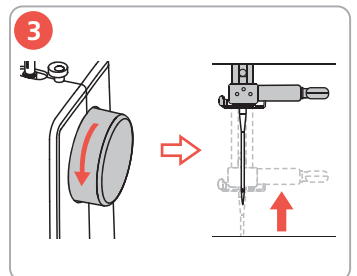
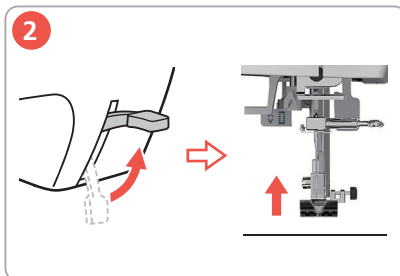
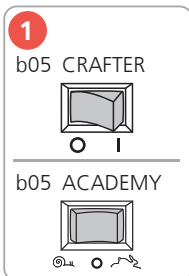
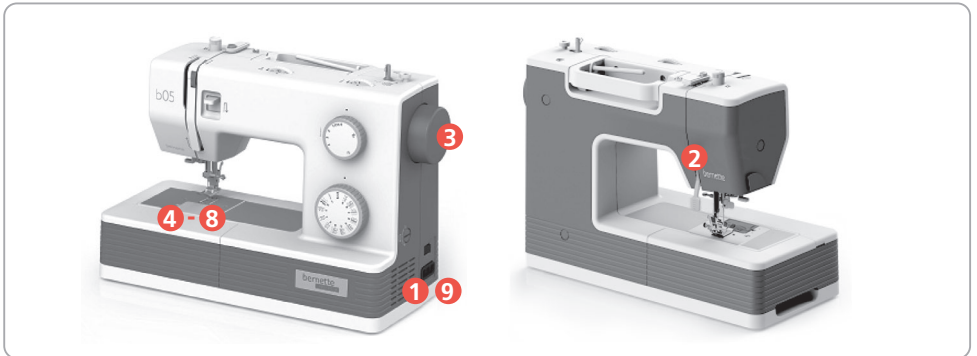

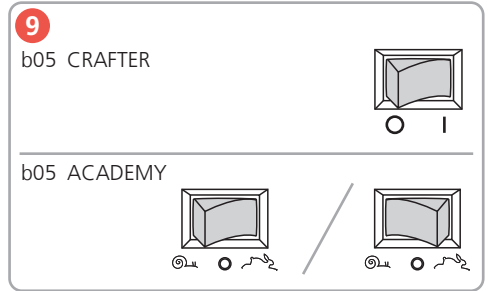
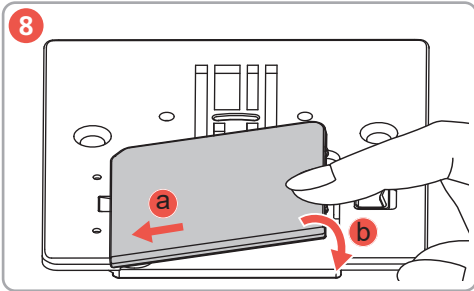
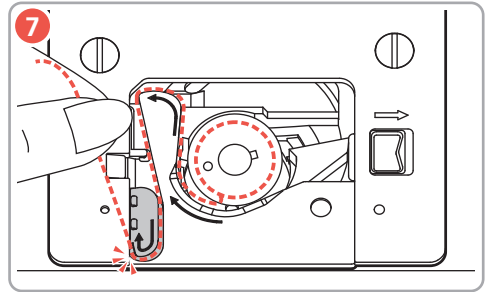
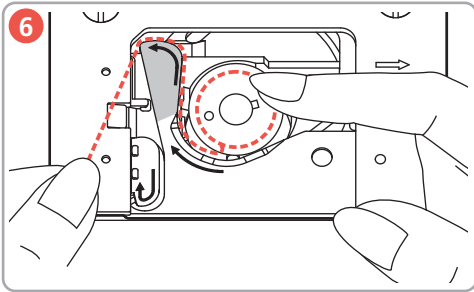
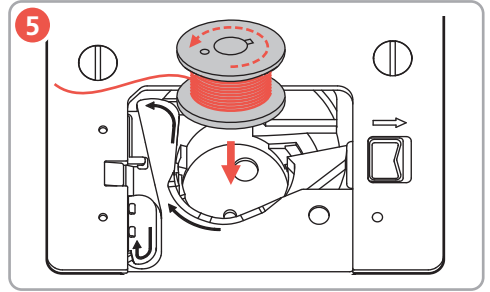
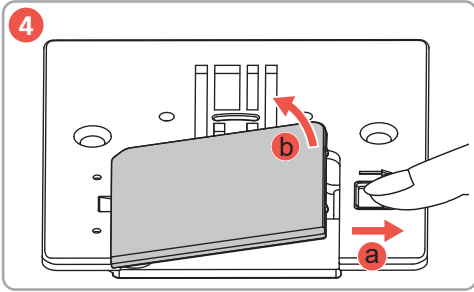

# Threading the upper thread

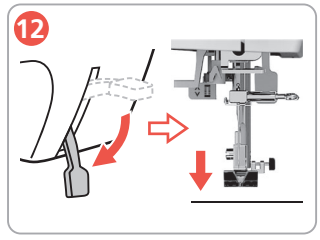
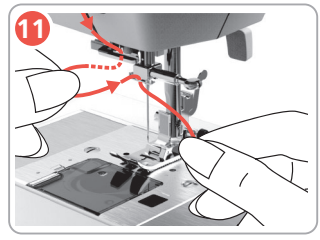
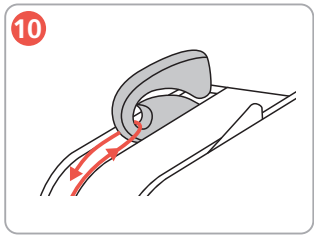
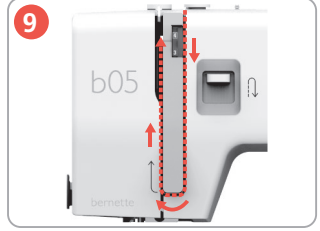
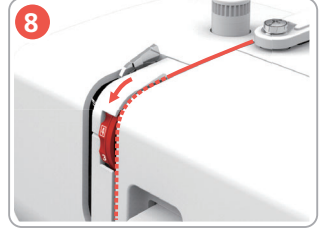
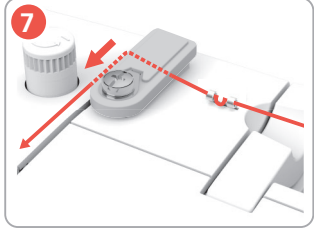
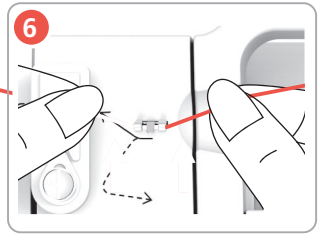
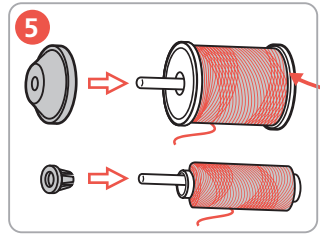
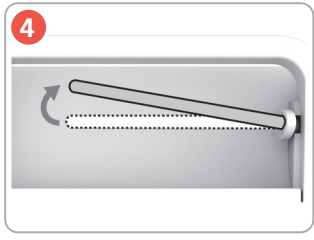
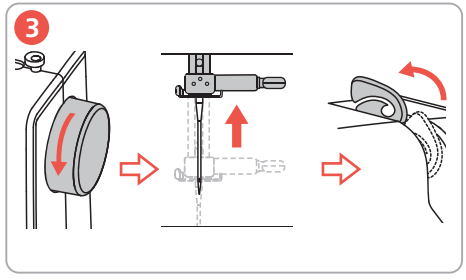
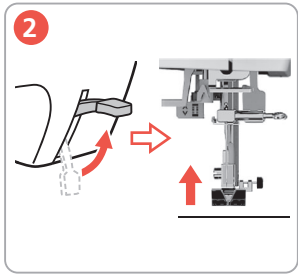
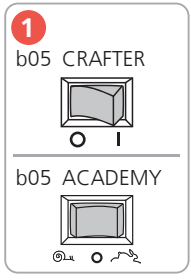
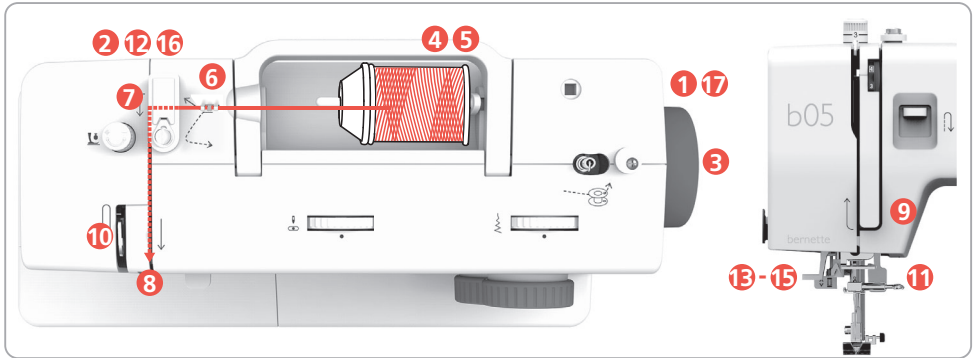

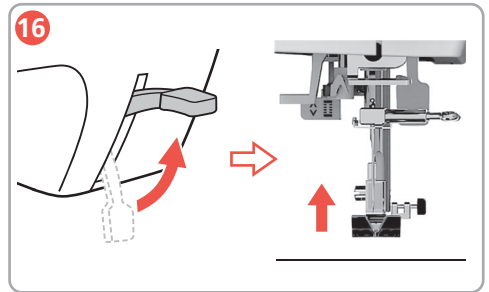
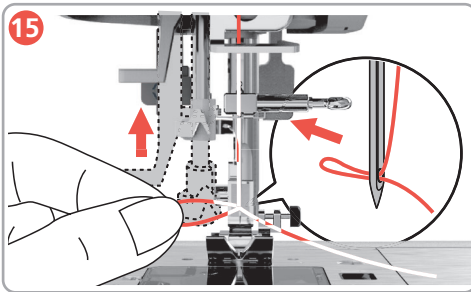
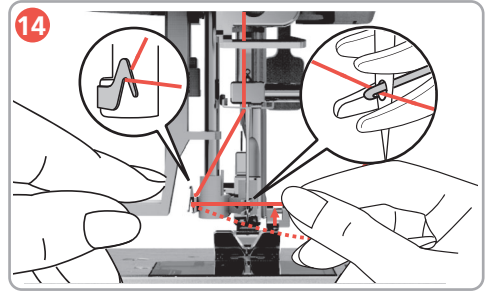
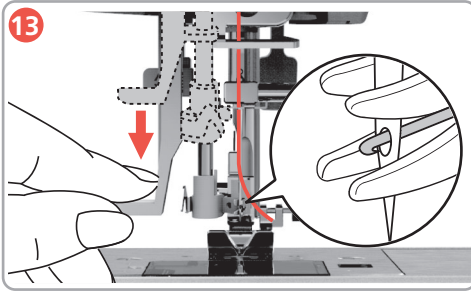

**17**

b05 CRAFTER

---

b05 ACADEMY

# Changing presser foot

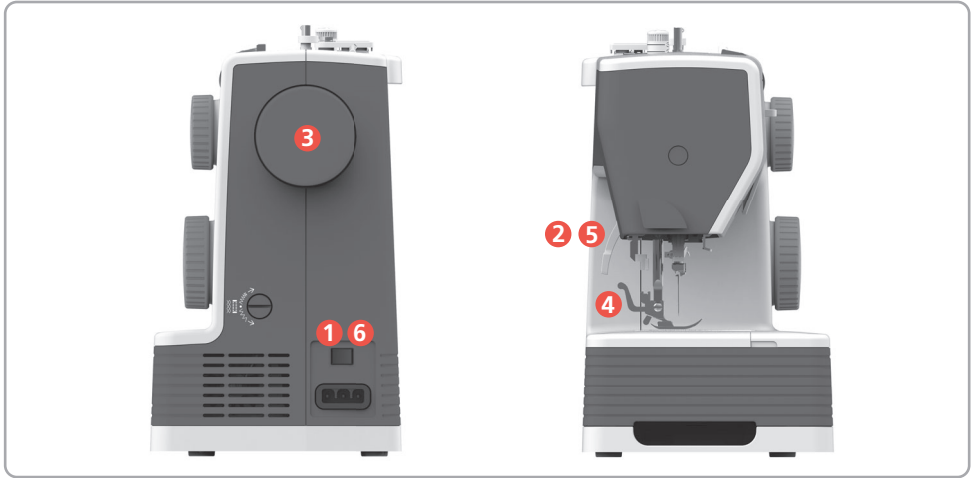

**1**

b05 CRAFTER



O I

---

b05 ACADEMY



Ⓛk ○ ↻

**2**

**3**

**4**

**5**

**6**



b05 CRAFTER



O I

---

b05 ACADEMY

Ⓛk ○ ↻

# Changing the needle

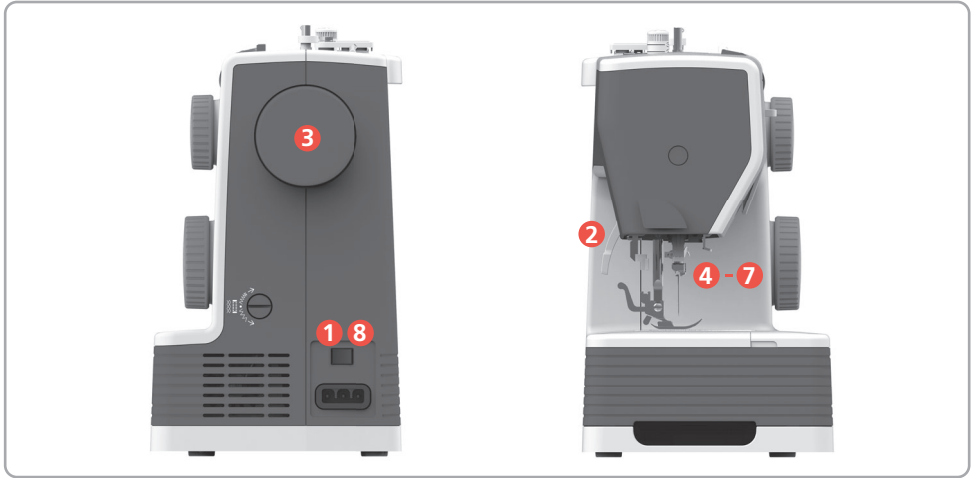

**1**

b05 CRAFTER



b05 ACADEMY



**2**

**3**

**4**

**5**

**6**



**7**

**8**

b05 CRAFTER



b05 ACADEMY

# Selecting stitches

Stitch length dial	Stitch selection dial												
		A	B	C	D	E	F	G	H	I	J	K	L
0~4													
S1													
S2													





# Selecting stitches in basic mode

**1**

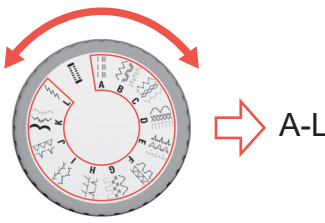

Stitch length dial	Stitch selection dial											
	A	B	C	D	E	F	G	H	I	J	K	L
1												
0~4	---	~~~~	~~~~	~~~~	~~~~	~~~~	~~~~	~~~~	~~~~	~~~~	~~~~	~~~~
S1		~~~~	~~~~	~~~~	~~~~	~~~~	~~~~	~~~~	~~~~	~~~~	~~~~	~~~~
S2		~~~~	~~~~	~~~~	~~~~	~~~~	~~~~	~~~~	~~~~	~~~~	~~~~	~~~~

**2**

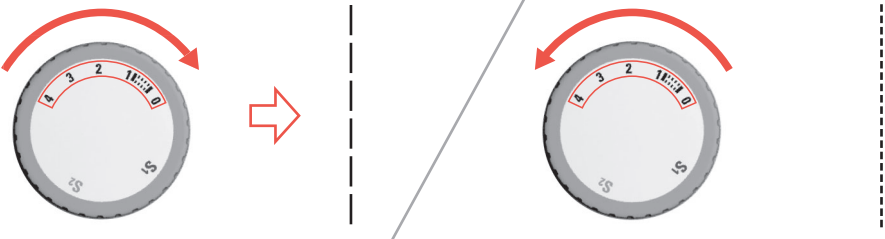

**3**



# Selecting stitches in Mode S1 or S2

**1**

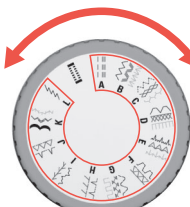

A-L

Stitch length dial	Stitch selection dial											
	A	B	C	D	E	F	G	H	I	J	K	L
1												
0~4												
S1												
S2												

**2**

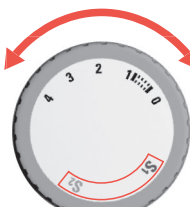

S1/S2

Stitch length dial	Stitch selection dial											
	A	B	C	D	E	F	G	H	I	J	K	L
1												
0~4												
S1												
S2												

**3**



## Selecting buttonhole

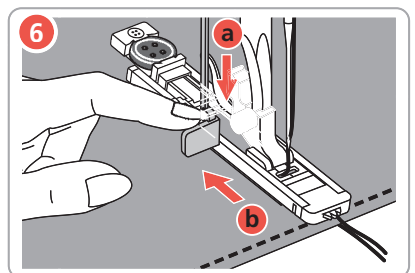
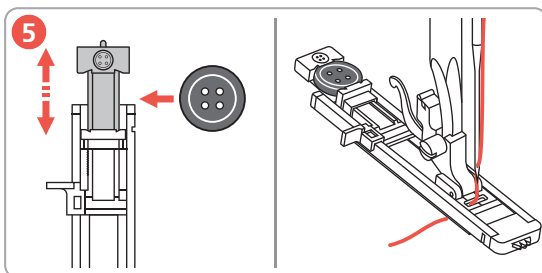
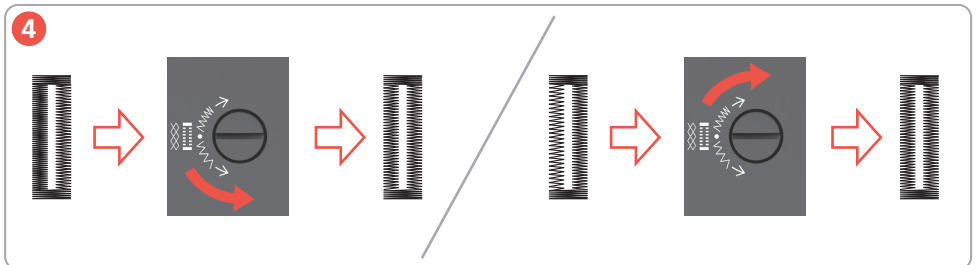
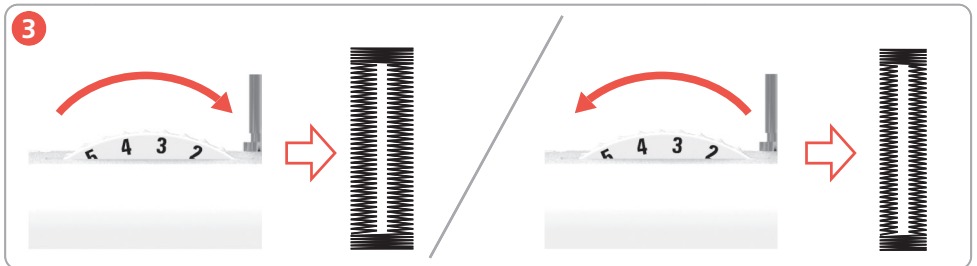
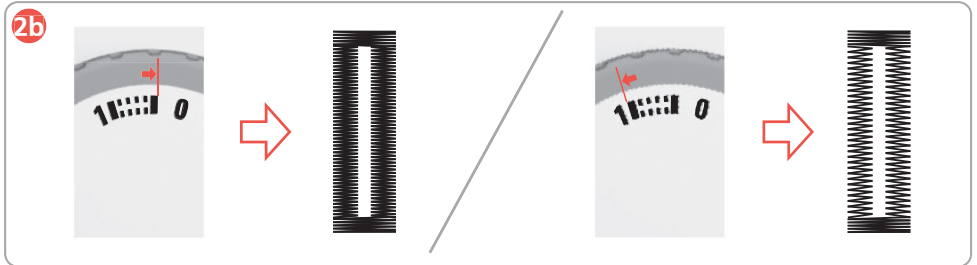
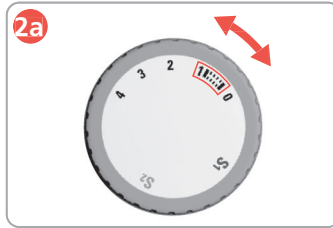
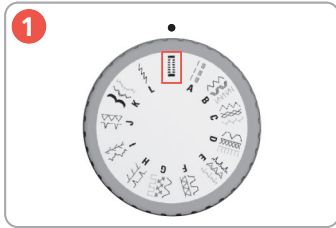

# Maintenance

## Clean machine surface

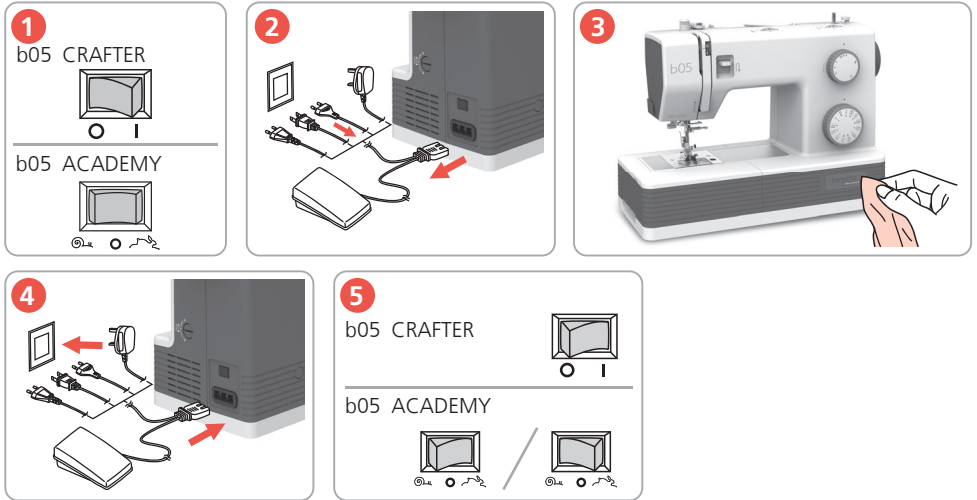

Do not use any organic solvents or detergents.

## Clean the feed dog

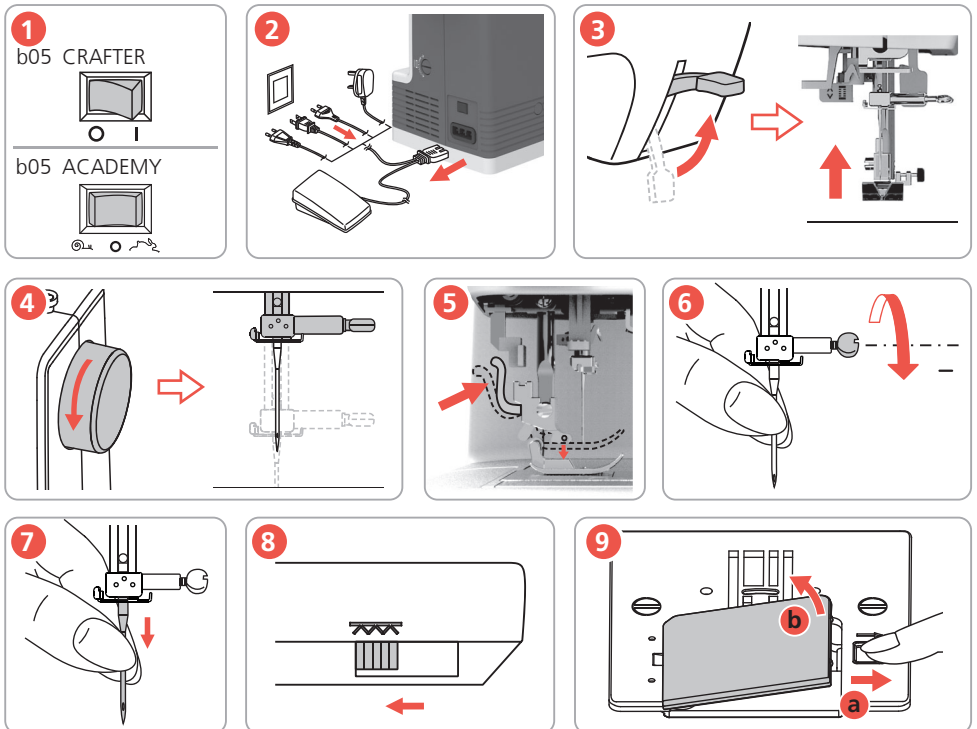

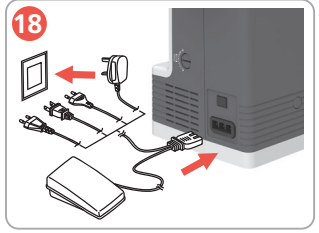
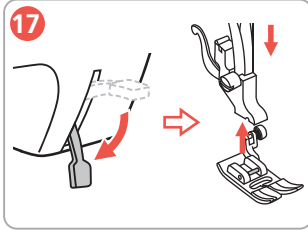
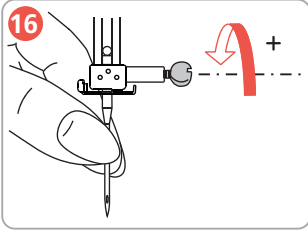
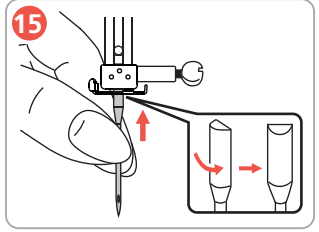
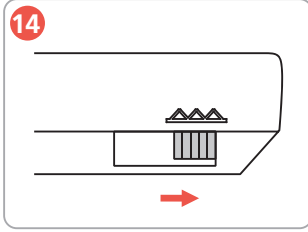
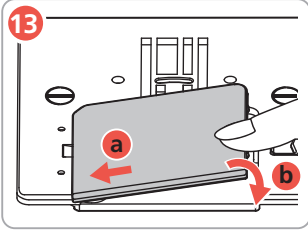
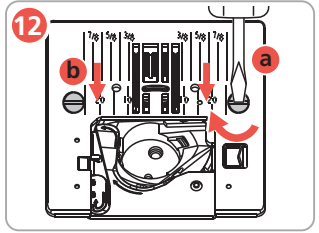
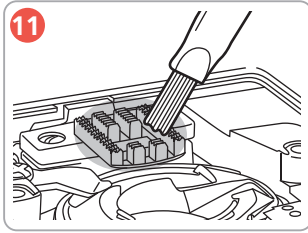
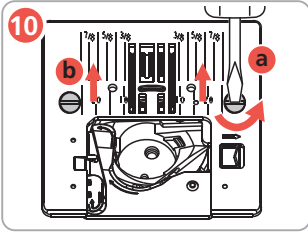



**19**

b05 CRAFTER 

---

b05 ACADEMY  / 

## Clean the hook

**1**  
b05 CRAFTER



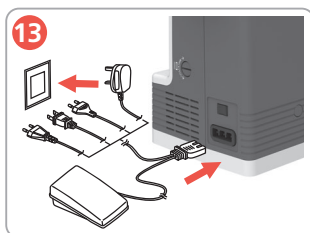
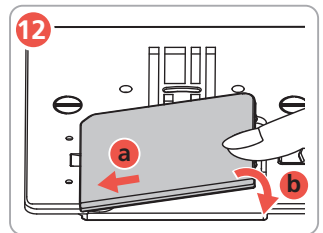
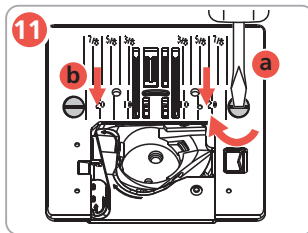
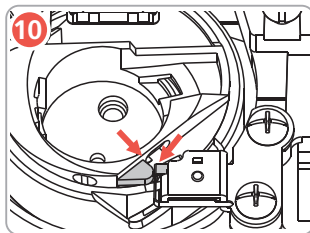
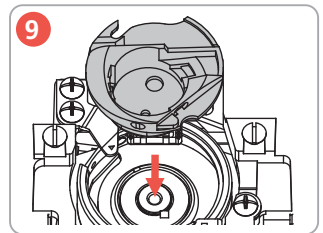
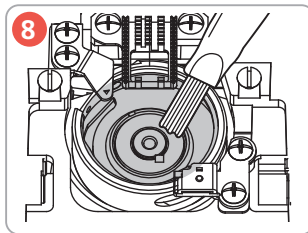
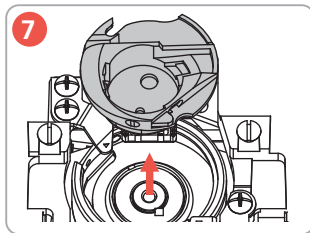
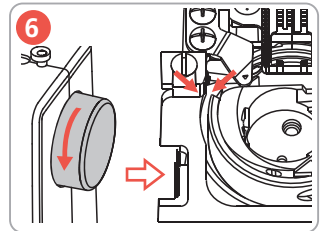
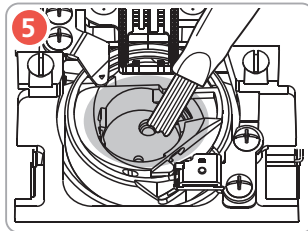
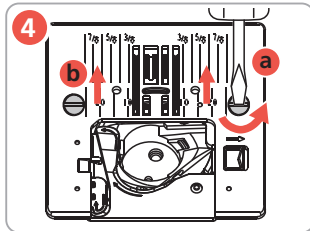
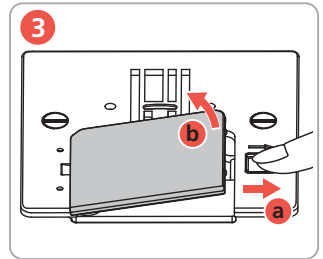
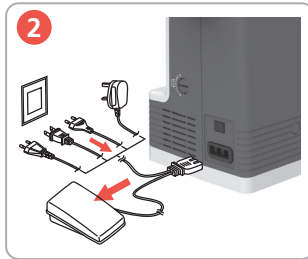

---

b05 ACADEMY





**14**  
b05 CRAFTER



---

b05 ACADEMY

## Oiling the needle bar

**1**

b05 CRAFTER





---

b05 ACADEMY

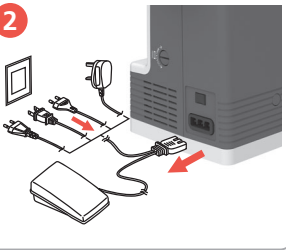

**2**



**3**

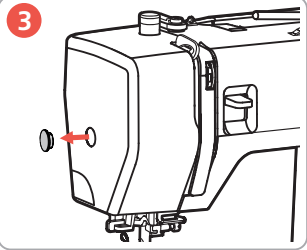

**4**

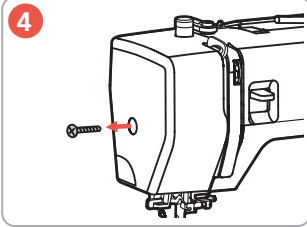

**5**

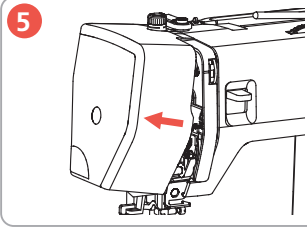

**6**

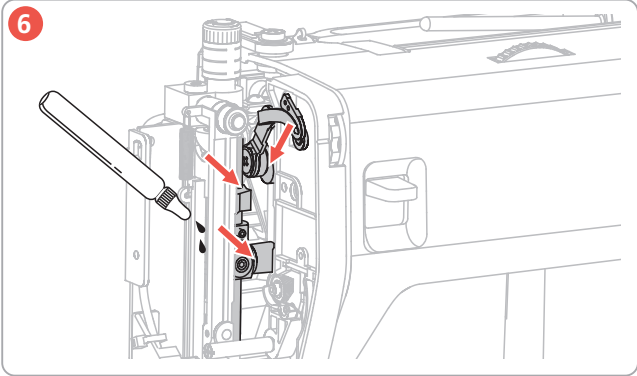

**7**

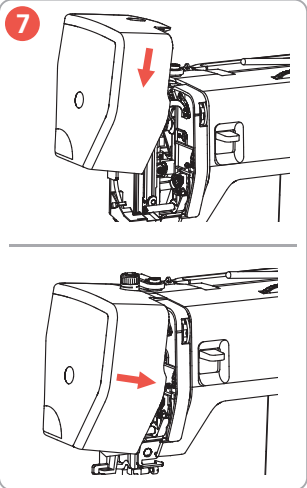

**▲ Attention**

After removing the face cover be careful of the moving parts.

**8**

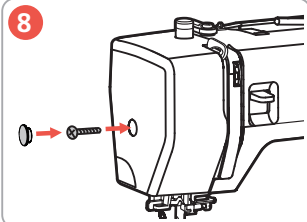

**9**

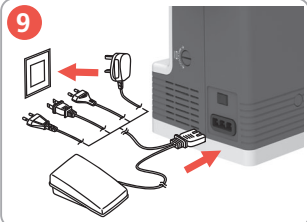



**10**

b05 CRAFTER



---

b05 ACADEMY

























# Troubleshooting











Fault	Cause	Repair
Uneven stitch formation	Upper thread too tight or too loose.	Adjust the upper thread tension.
	Needle blunt or bent.	Replace the needle, make sure that a new BERNINA quality needle is used.
	Poor quality needle.	Use a new BERNINA quality needle.
	Poor quality thread.	Use quality thread.
	Incorrect needle/thread combination.	Match the needle with the thread size.
	Incorrectly threaded.	Rethread.
	The fabric has been pulled.	Feed the fabric evenly.
	Dust or thread remnants under the tension spring of the bobbin case.	Clean the hook.
Skipped stitches	Incorrect needle.	Use the needle system 130/705H.
	Needle blunt or bent.	Replace the needle.
	Poor quality needle.	Use a new BERNINA quality needle.
	The needle is incorrectly inserted.	Insert the needle with the flat side to the back as far up as it will go into the needle holder and tighten the screw.
	Incorrect needle point.	Match the needle point to the texture of the material.
Faulty stitching	Thread remnants between the thread tension discs.	Fold a piece of thin material and slide the folded edge (not the raw edges) between the thread tension discs.
	Incorrectly threaded.	Rethread.
	Thread is caught in the hook.	Remove the upper thread and the bobbin case, turn the handwheel backwards and forwards by hand and remove the thread remnants.
	Incorrect needle/thread combination.	Check the needle/thread combination.
Upper thread breaks	Incorrect needle/thread combination.	Match the needle with the thread size.
	Upper thread is too tight.	Reduce the upper thread tension.
	Incorrectly threaded.	Rethread.
	Poor quality thread.	Use quality thread.
	The stitch plate or the hook tip is damaged.	<ul style="list-style-type: none"> <li>- Contact a specialized bernette dealer to have the damages repaired.</li> <li>- Replace the stitch plate.</li> </ul>



<b>Fault</b>	<b>Cause</b>	<b>Repair</b>
Lower thread breaks	The bobbin is not inserted correctly.	- Remove and reinsert the bobbin and pull on the thread. →The thread should run easily.
	Bobbin is wound incorrectly.	Check bobbin and thread correctly.
	The stitch hole in the stitch plate is damaged.	- Contact a specialized bernette dealer to have the damages repaired. - Replace the stitch plate.
	Needle blunt or bent.	Replace the needle.
Needle breaks	The needle is incorrectly inserted.	Insert the needle with the flat side to the back as far up as it will go into the needle holder and tighten the screw.
	The fabric has been pulled.	Feed the fabric evenly.
	Thick fabric has been pushed.	- Use the appropriate presser foot, e.g. Jeans foot, for thick material. - Use the height compensating tool when sewing over a thick seam.
	Knotted thread.	Use quality thread.
The machine doesn't start	The machine is not turned on.	Turn on the machine.
	The presser foot lifter is raised.	Lower the presser foot lifter.
	The machine is not plugged in.	Connect the power cord to the electric outlet.
	The machine is damaged.	Contact a specialized bernette dealer.
Neither the sewing light nor the light on the free arm lights up	The sewing light is defect.	Contact a specialized bernette dealer.

# Overview of the stitches

Pattern NO.			----		Tension		Needle Position		
									
	BH	4~6	0.3~0.5	2	4		V	V	V
----	A	0	0.5~4	2	4	V	V	V	V
≡≡≡≡	S1_A	0	S1	2	4		V	V	V
	B	2~6	0.3~4	2	4	V	V	V	V
	S1_B	3~6	S1	2	4		V	V	V
	S2_B	3~6	S2	2	4		V	V	V
	C	3~6	0.5~2.5	2	4	V	V	V	V
	S1_C	3~6	S1	2	4		V	V	V
	S2_C	3~6	S2	2	4		V	V	V
	D	3~6	1~3	2	4	V	V	V	V
	S1_D	3~6	S1	2	4		V	V	V
	S2_D	3~6	S2	2	4		V	V	V
	E	3~6	0.5~1.5	2	4	V	V	V	V
	S1_E	3~6	S1	2	4		V	V	V
	S2_E	3~6	S2	2	4		V	V	V
	F	3~6	0.5~2	2	4	V	V	V	V
	S1_F	3~6	S1	2	4		V	V	V
	G	3~6	0.5~2	2	4	V	V	V	V
	S1_G	3~6	S1	2	4		V	V	V
	S2_G	3~6	S2	2	4		V	V	V

Pattern NO.			-----		Tension		Needle Position		
									
..Λ..Λ..Λ.	H	3~6	1~2.5	2	4	V	V	V	V
///	S1_H	3~6	0.5~4	2	4		V	V	V
√√√√	I	3~6	0.5~2	2	4	V	V	V	V
←←←←	S1_I	3~6	S1	2	4		V	V	V
∩∩∩∩	J	3~6	1~2.5	2	4	V	V	V	V
∇∇∇∇	S1_J	3~6	S1	2	4		V	V	V
	K	3~6	0.5~1.5	2	4	V	V	V	V
	S1_K	3~6	S1	2	4		V	V	V
	S2_K	3~6	S2	2	4		V	V	V
	L	1~2.5	3~4	2	4		V	V	V





For complete instructions, you can link to the online user manual and how to videos [www.bernette.com](http://www.bernette.com) or scan the QR-Code with your smart phone.



[www.bernette.com/b05ACADEMY](http://www.bernette.com/b05ACADEMY)



[www.bernette.com/b05CRAFTER](http://www.bernette.com/b05CRAFTER)

5200105.0.04 / 021Q6K0101 | en 2020-10  
© BERNINA International AG  
Steckborn CH, [www.berнина.com](http://www.berнина.com)