





View this machine and more at:

<https://www.thesewingstudio.co.uk>

1

Stitches: 3 879
Height: 145 mm
Width: 72 mm

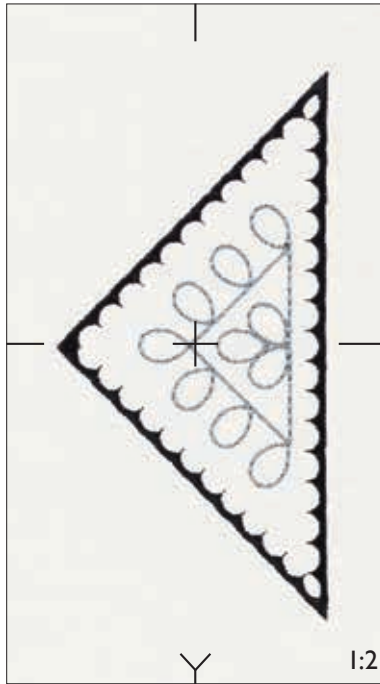

1  1011
2585
2  1005
2296

Gütermann Sulky
Robison - Anton



2

Stitches: 7 516
Height: 220 mm
Width: 136 mm

1  1822
2489
2  1822
2489

Gütermann Sulky
Robison - Anton

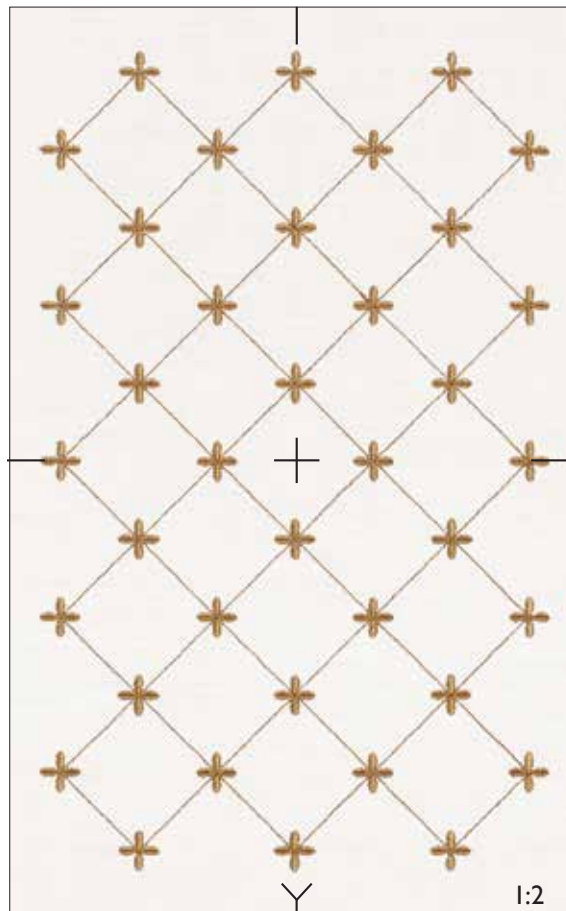

3

Stitches: 5 451
Height: 72 mm
Width: 42 mm

- 1 ■ 1005
2296
- * ■ 1005
2296
- 2 ■ 1005
2296
- ✂ 1005
- 3 ■ 2296

Gütermann Sulky
Robison - Anton

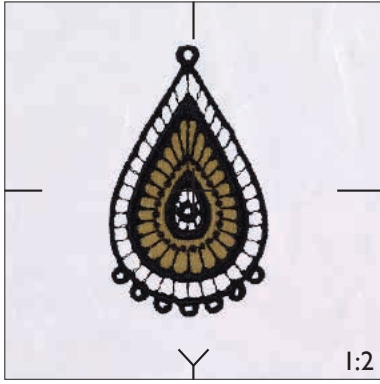

4

Stitches: 5 639
Height: 71 mm
Width: 93 mm

- 1 ■ 1005
2296
- * ■ 1005
2296
- 2 ■ 1005
2296
- 3 ■ 1813
2380
- 4 ■ 1065
2465
- 5 ■ 1230
2615
- ✂ 1005
- 6 ■ 2296

Gütermann Sulky
Robison - Anton

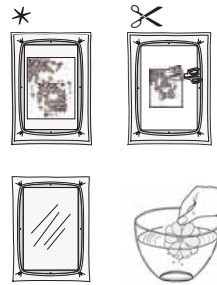
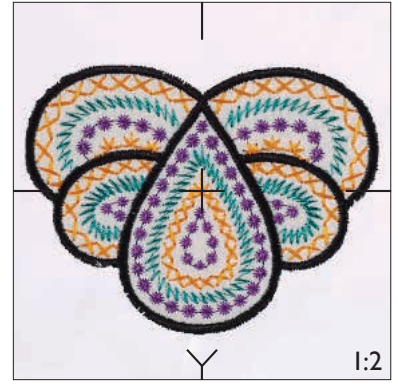

5

Stitches: 2 683
 Height: 238 mm
 Width: 118 mm

1 ■ 1005
 2296

Gütermann Sulky
 Robison - Anton

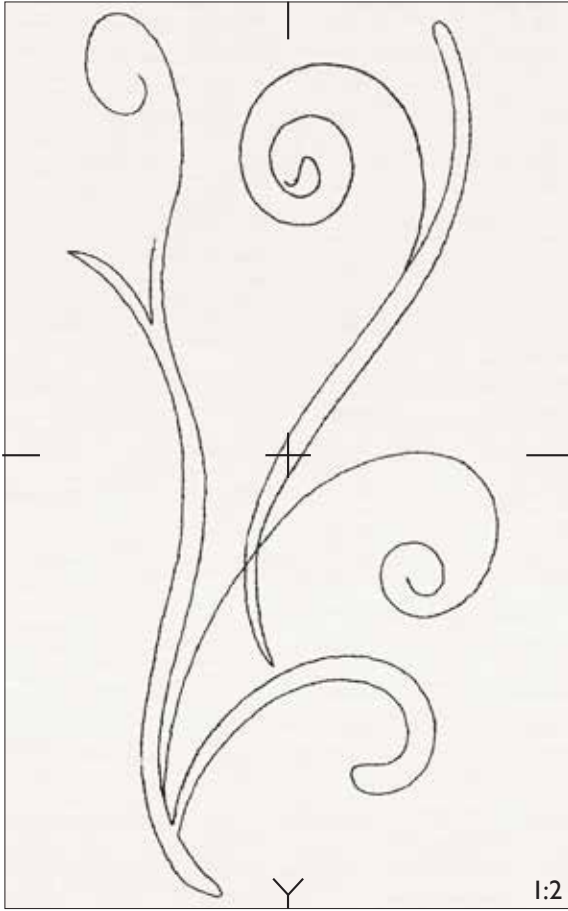

6

Stitches: 8 378
 Height: 100 mm
 Width: 107 mm

1 ■ 1005
 * 2296
 2 ■ 1005
 2296
 ✂ 3 ■ 1041
 2585
 ✂ 4 ■ 1005
 2296

Gütermann Sulky
 Robison - Anton

* Reversed appliqué

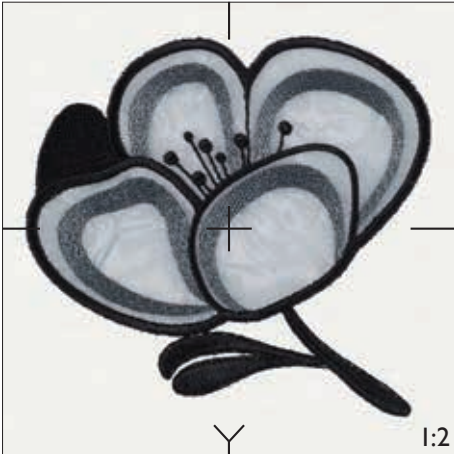

7

Stitches: 8 654
 Height: 105 mm
 Width: 83 mm

1 ■ 1005
 * 2296
 2 ■ 1005
 2296
 ✂ 3 ■ 1041
 2585
 ✂ 4 ■ 1005
 2296

Gütermann Sulky
 Robison - Anton

* Reversed appliqué

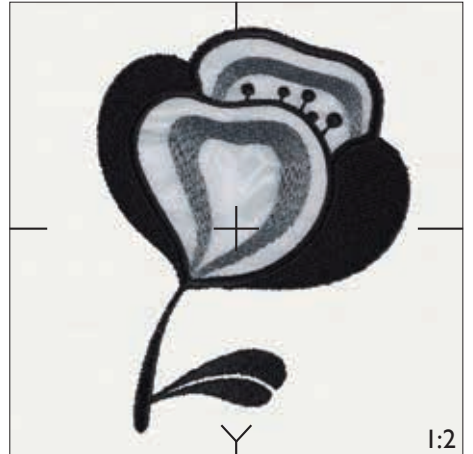

8

Stitches: 3 606
Height: 166 mm
Width: 66 mm

1 1813
2426

Gütermann Sulky
Robison - Anton

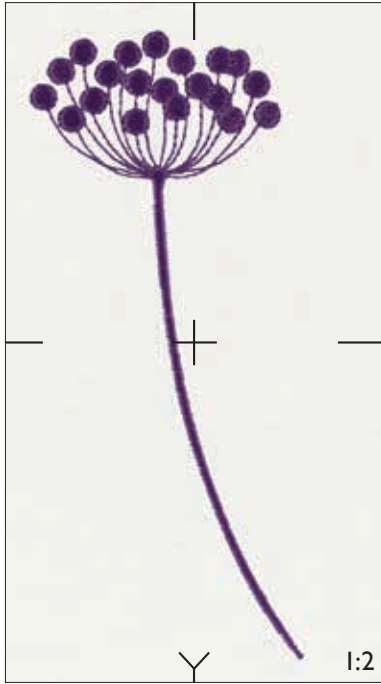

9

Stitches: 6 219
Height: 60 mm
Width: 60 mm

1 1813
2426

2 1231
2261

3 1813
2426

4 1121
2599

5 1001
2343

Gütermann Sulky
Robison - Anton

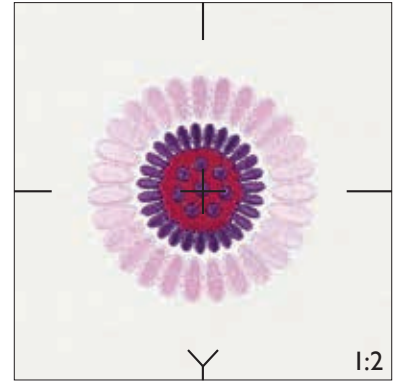

10

Stitches: 3 469
Height: 64 mm
Width: 64 mm

1 1121
2599

2 1065
2465

3 1813
2426

Gütermann Sulky
Robison - Anton

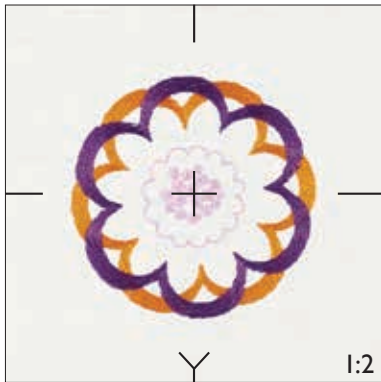

11

Stitches: 4 553
Height: 60 mm
Width: 44 mm



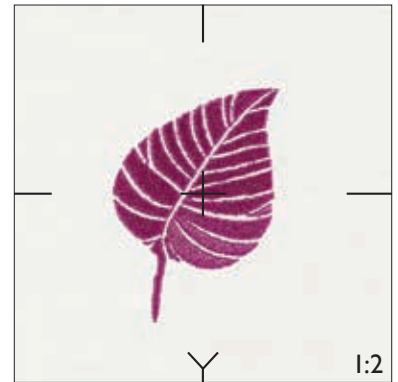

1 1231
2261

Gütermann Sulky
Robison - Anton



12

Stitches: 5 447
Height: 83 mm
Width: 101 mm





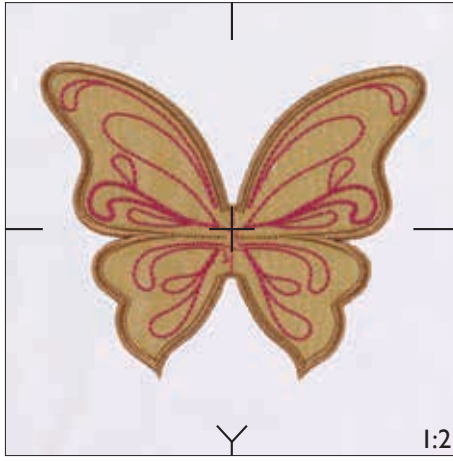

- 1  1822
2489
- * 2  1822
2489
- 3  1231
2261
- ✂ 4  1822
2489

Gütermann Sulky
Robison - Anton



13

Stitches: 5 289
Height: 75 mm
Width: 83 mm



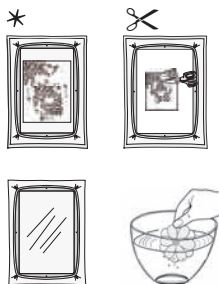
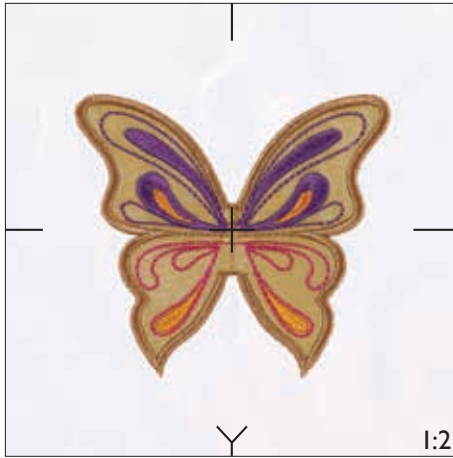

- 1  1822
2489
- * 2  1822
2489
- 3  1231
2261
- 4  1813
2426
- 5  1065
2465
- ✂ 6  1822
2489

Gütermann Sulky
Robison - Anton



14

Stitches: 2 212
Height: 70 mm
Width: 43 mm

- 1  1230
2615
- Δ 2  1230
2615
- 3  1288
2204
- 4  1230
2615

Gütermann Sulky
Robison - Anton

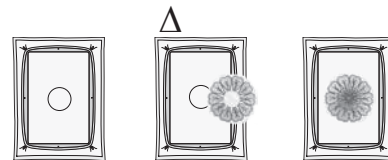
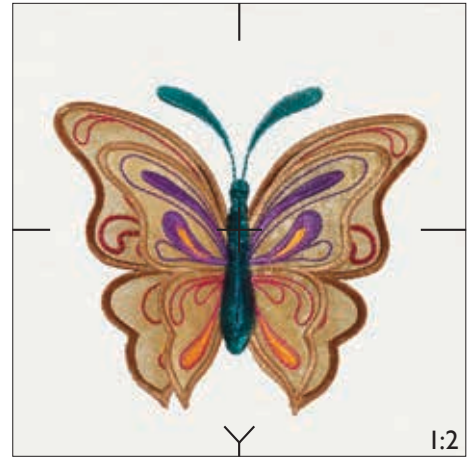

✂ Thread Velvet™





15

Stitches: 8 646
Height: 111 mm
Width: 130 mm





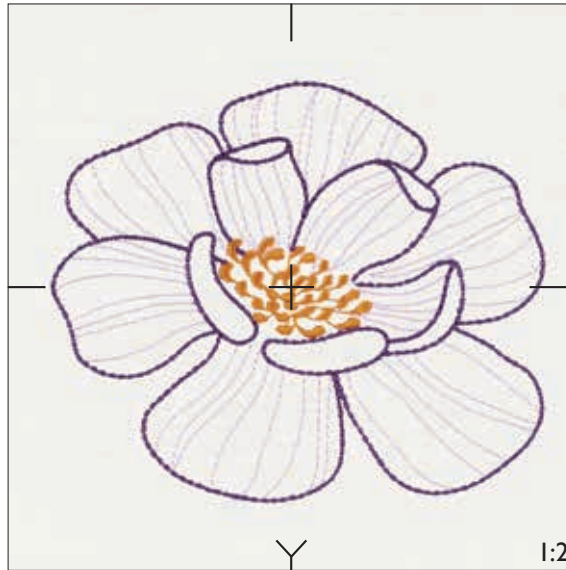

- 1  1121
2599
- 2  1813
2426
- 3  1065
2465

Gütermann Sulky
Robison - Anton



16

Stitches: 6 562
Height: 108 mm
Width: 110 mm

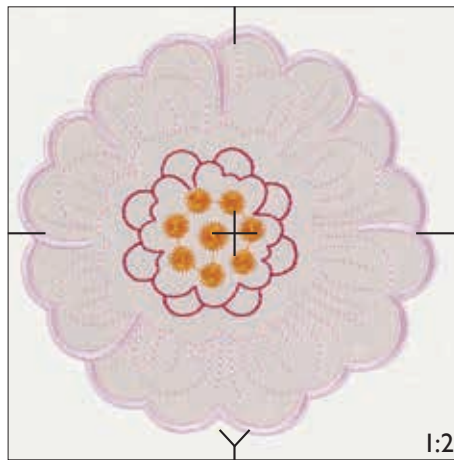
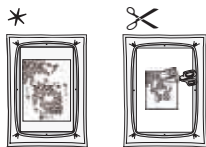

- 1  1121
2599
- *  1121
2599
- 2  1121
2599
- 3  1065
2465
- 4  1231
2261
- 5  1121
2599
- 6  1121
2599

Gütermann Sulky
Robison - Anton



17

Stitches: 3 825
Height: 140 mm
Width: 140 mm

- 1  1231
2261
- 2  1065
2465

Gütermann Sulky
Robison - Anton

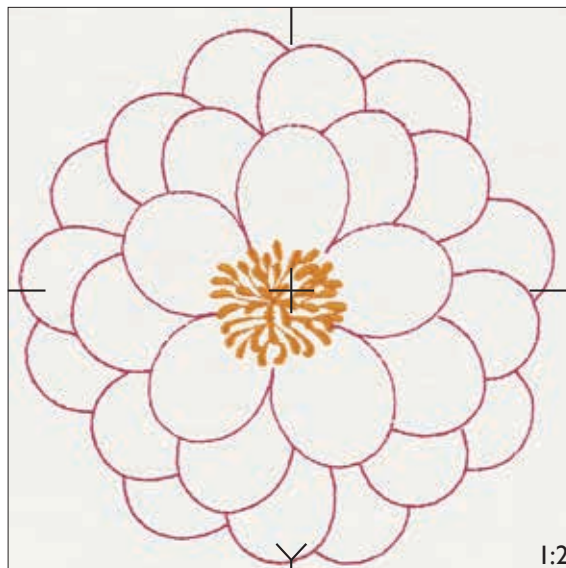

18

Stitches: 3 602
Height: 145 mm
Width: 145 mm

1  1288
2204

Gütermann Sulky
Robison - Anton

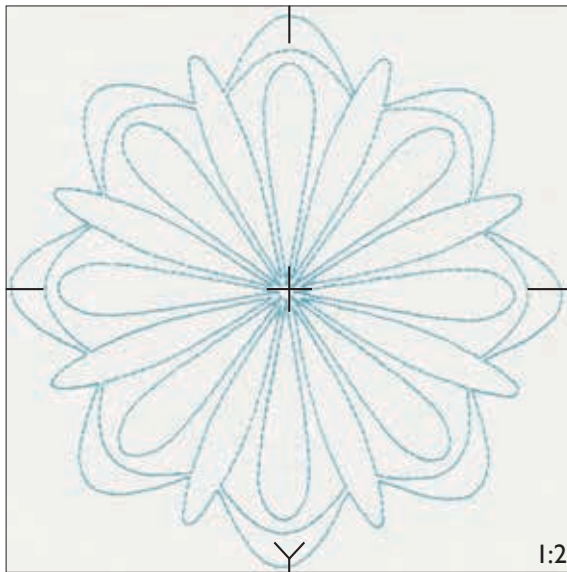

19

Stitches: 11 902
Height: 135 mm
Width: 135 mm

1  1288
2204

2  1172
2308

3  1082
2335

4  1822
2489

Gütermann Sulky
Robison - Anton

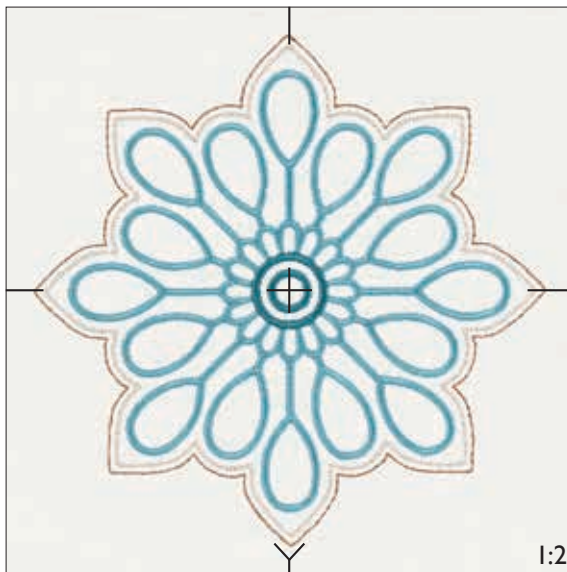

20

Stitches: 359
Height: 14 mm
Width: 14 mm

1  1231
2261

Gütermann Sulky
Robison - Anton

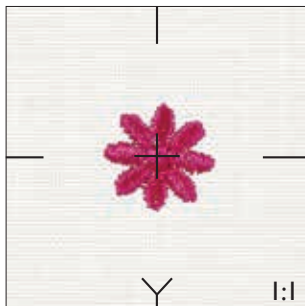

21

Stitches: 394
Height: 16 mm
Width: 16 mm

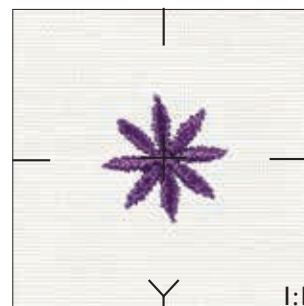

1  1813
2380

Gütermann Sulky
Robison - Anton



22

Stitches: 4 620
Height: 65 mm
Width: 65 mm

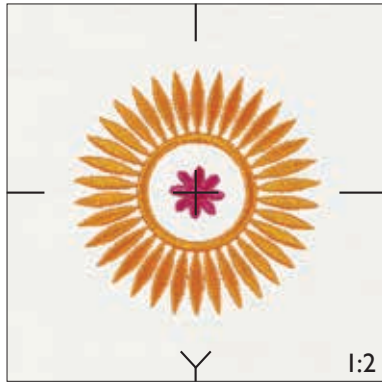

- 1  1065
2465
- 2  1231
2261

Gütermann Sulky
Robison - Anton



23

Stitches: 4 656
Height: 65 mm
Width: 65 mm

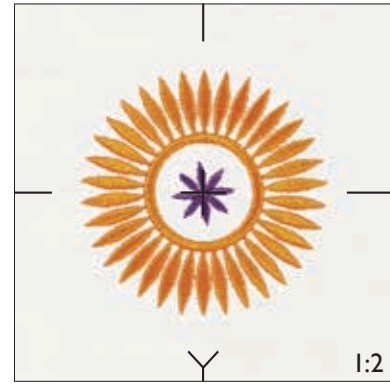

- 1  1065
2465
- 2  1813
2380

Gütermann Sulky
Robison - Anton



24

Stitches: 5 282
Height: 65 mm
Width: 65 mm

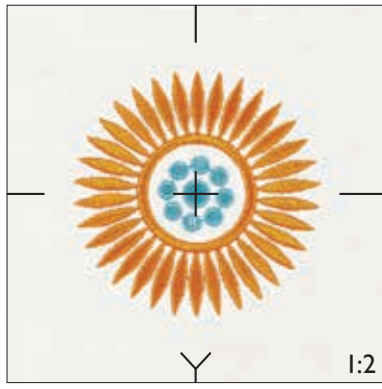

- 1  1065
2465
- 2  1288
2204

Gütermann Sulky
Robison - Anton



25

Stitches: 3 324
Height: 45 mm
Width: 45 mm

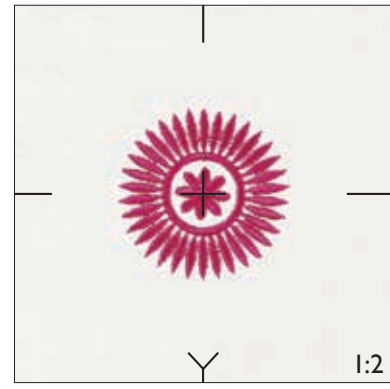

- 1  1231
2261
- 2  1231
2261

Gütermann Sulky
Robison - Anton



26

Stitches: 3 359
Height: 45 mm
Width: 45 mm

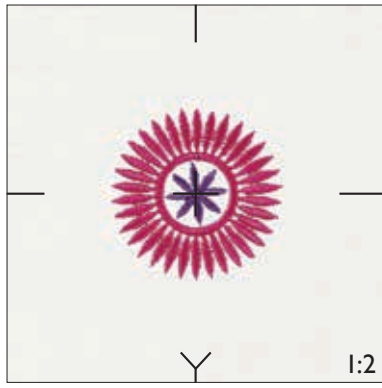

- 1  1813
2380
- 2  1231
2261

Gütermann Sulky
Robison - Anton



27

Stitches: 3 140
Height: 45 mm
Width: 45 mm

- 2  1231
2261
- 1  1065
2465

Gütermann Sulky
Robison - Anton

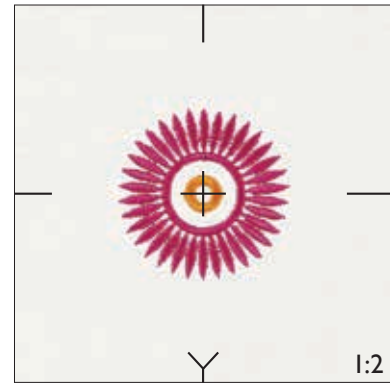



28

Stitches: 25 442
Height: 239 mm
Width: 143 mm

- | | | | | | |
|---|--|--------------|----|--|--------------|
| 1 | | 1082
2232 | 10 | | 1283
2386 |
| 2 | | 1056
2569 | 11 | | 1239
2394 |
| 3 | | 1034
2611 | 12 | | 1158
2569 |
| 4 | | 1035
2622 | * | | |
| 5 | | 567
2401 | 13 | | 1034
2611 |
| * | | | < | | |
| 6 | | 567
2401 | 14 | | 1034
2611 |
| < | | | 15 | | 1035
2622 |
| 7 | | 567
2401 | 16 | | 1034
2611 |
| 8 | | 1074
2300 | 17 | | 567
2401 |
| 9 | | 1291
2536 | 18 | | 1170
2402 |

Gütermann Sulky
Robison - Anton



29

Stitches: 7 498
Height: 239 mm
Width: 141 mm

- | | | |
|---|--|--------------|
| 1 | | 1056
2569 |
|---|--|--------------|

Gütermann Sulky
Robison - Anton



30

Stitches: 10 325
Height: 239 mm
Width: 149 mm

- 1 1082
2232
- 2 1034
2611
- * 1034
2611
- 3 1034
2611
- < 1034
2611
- 4 1034
2611
- 5 1035
2622
- 6 1034
2611
- 7 1239
2201
- 8 567
2401
- 9 1170
2402
- 10 1056
2569

Gütermann Sulky
Robison - Anton

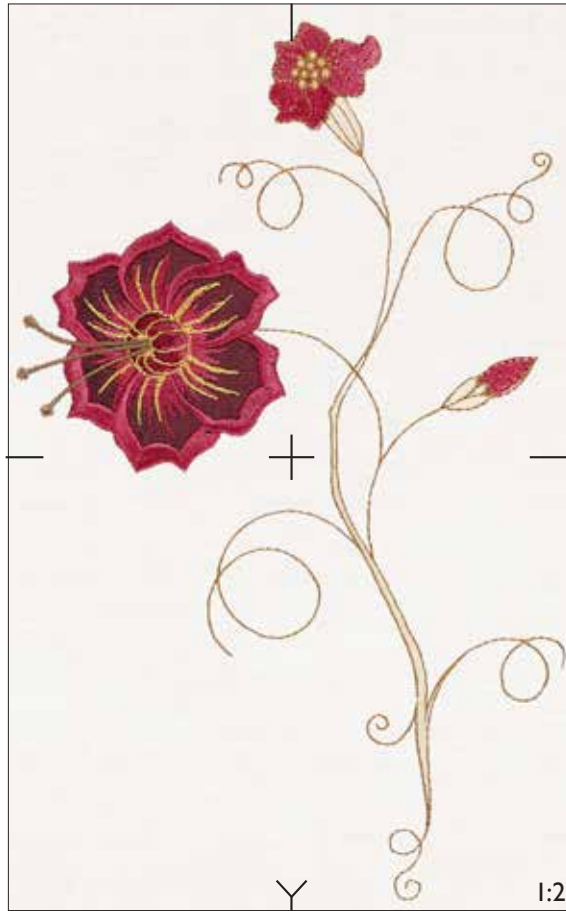
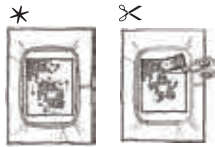

1:2

31

Stitches: 4 322
Height: 239 mm
Width: 149 mm

- 1 1056
2569















Gütermann Sulky
Robison - Anton



1:2

32

Stitches: 12 292
Height: 117 mm
Width: 100 mm

- 1  1071
2574
- *  1071
2574
- 2  1071
2574
- 3  1071
2574
- 4  1017
2413
- 5  502
2398
- 6  1034
2611
- 7  1035
2622
- 8  1239
2394
- 9  1291
2536
- 10  1283
2386
- 11  1276
2572
- 12  630
2551
- 13  1057
2251

Gütermann Sulky
Robison - Anton



33

Stitches: 3 121
Height: 117 mm
Width: 100 mm

- 1  1056
2569

Gütermann Sulky
Robison - Anton

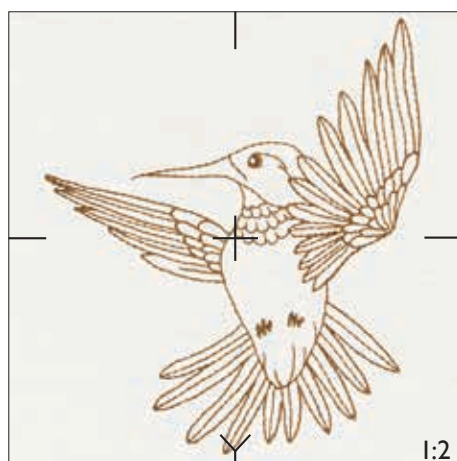



34

Stitches: 4 511
 Height: 78 mm
 Width: 74 mm

- 1 1034
2611
- * 2 1034
2611
- ✂ 3 1034
2611
- 4 1035
2622
- 5 1034
2611
- 6 567
2401
- 7 1170
2402

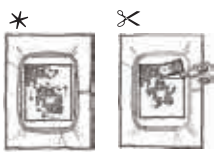
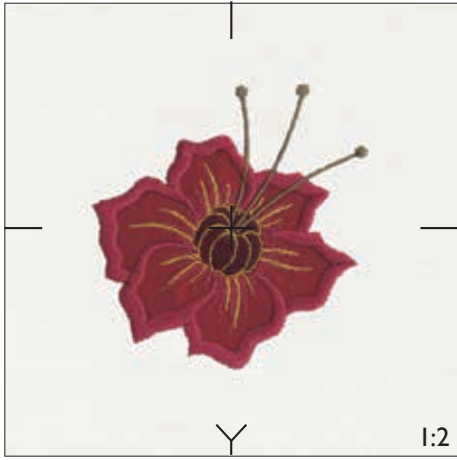

Gütermann Sulky
 Robison - Anton

35

Stitches: 16 805
 Height: 63 mm
 Width: 64 mm

- 1 1169
2249
- 2 1039
2508
- 3 1169
2249
- 4 1039
2508



Gütermann Sulky
 Robison - Anton
 ✂ Thread Velvet™

36

Stitches: 15 101
 Height: 60 mm
 Width: 74 mm

- 1 1169
2249
- 2 1039
2508
- 3 1169
2249
- 4 1039
2508



Gütermann Sulky
 Robison - Anton
 ✂ Thread Velvet™

37

Stitches: 3 174
 Height: 83 mm
 Width: 122 mm

- 1 1104
2282
- 2 1206
2521

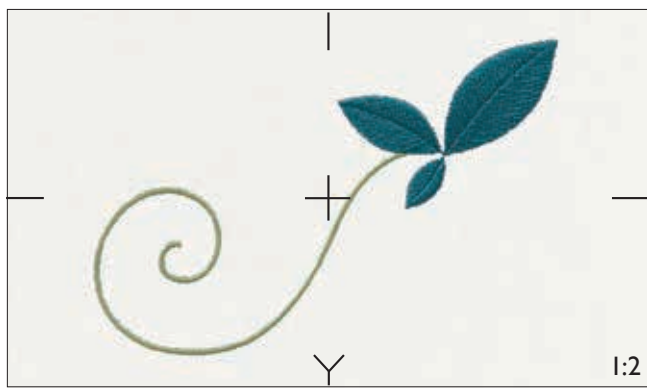

Gütermann Sulky
 Robison - Anton

38

Stiches: 3 146
Height: 127 mm
Width: 96 mm

1 ■ 1234
2296

Gütermann Sulky
Robison - Anton

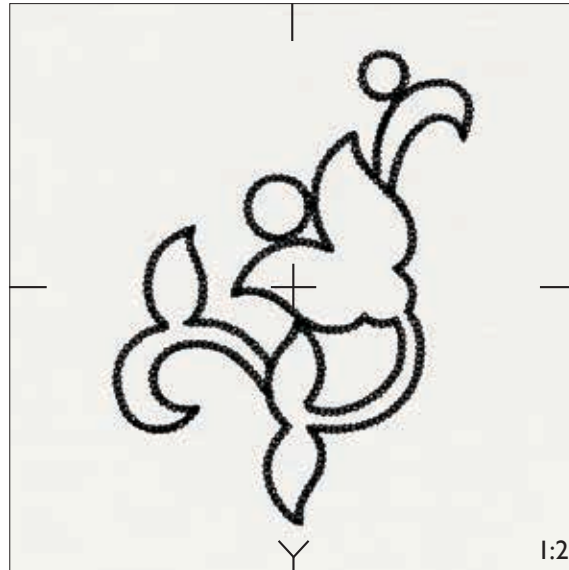

39

Stiches: 1 874
Height: 96 mm
Width: 66 mm

1 ■ 1234
2296

Gütermann Sulky
Robison - Anton

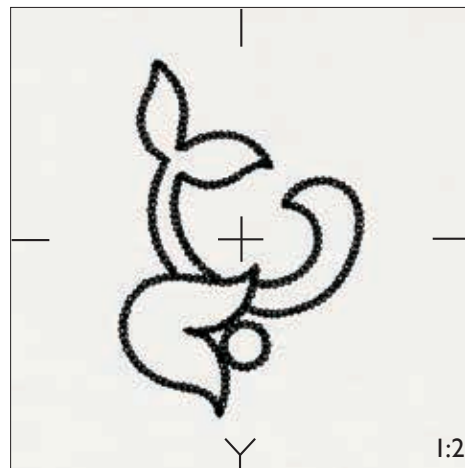

40

Stiches: 1 502
Height: 71 mm
Width: 77 mm

1 ■ 1234
2296

Gütermann Sulky
Robison - Anton

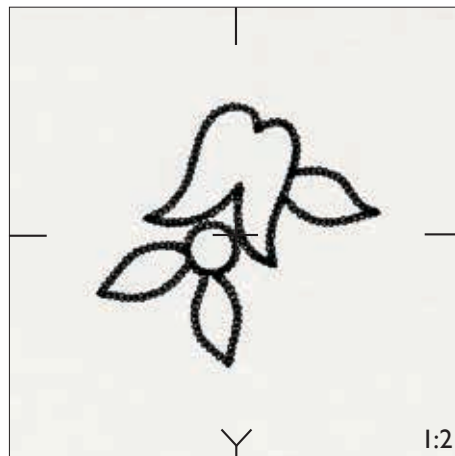







Designs # 42, 44, 45



Designs # 41, 43

41

Stitches: 4 824
Height: 50 mm
Width: 51 mm

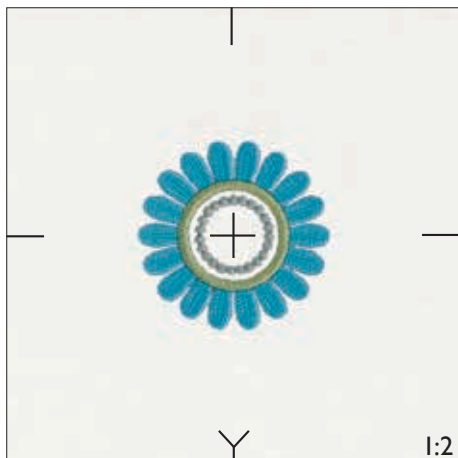

- 1  1011
2618
- 2  1248
2239
- 3  1096
2446
- 4  1104
2282

Gütermann Sulky
Robison - Anton



42

Stitches: 2 772
Height: 41 mm
Width: 47 mm

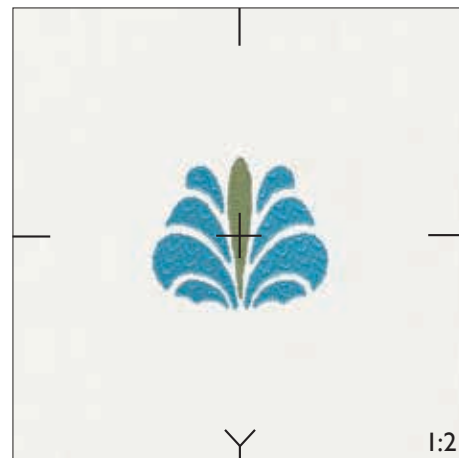

- 1  1104
2282
- 2  1248
2239

Gütermann Sulky
Robison - Anton



43

Stitches: 3 789
Height: 63 mm
Width: 44 mm



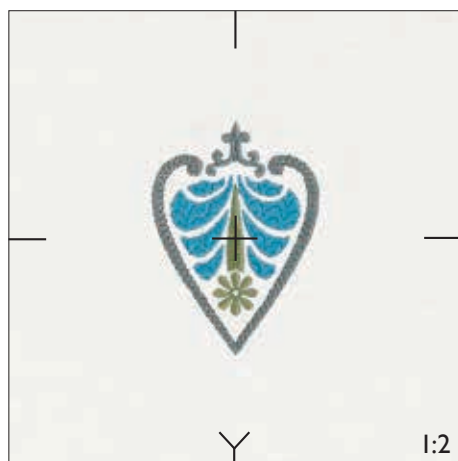

- 1  1104
2282
- 2  1248
2239
- 3  1011
2618

Gütermann Sulky
Robison - Anton



44

Stitches: 2 907
Height: 41 mm
Width: 87 mm

- 1  1104
2282
- 2  1011
2618
- 3  1248
2239
- 4  1104
2282

Gütermann Sulky
Robison - Anton

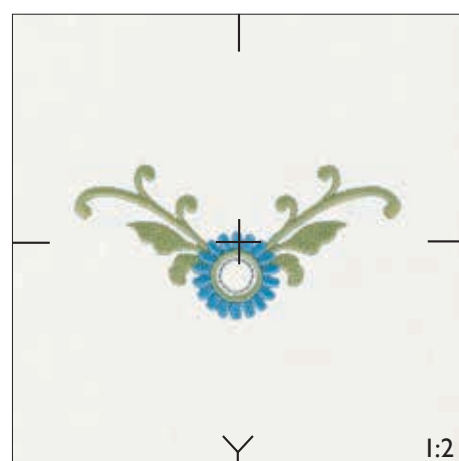

45

Stitches: 1 048
Height: 40 mm
Width: 33 mm

- 1  1104
2282

Gütermann Sulky
Robison - Anton

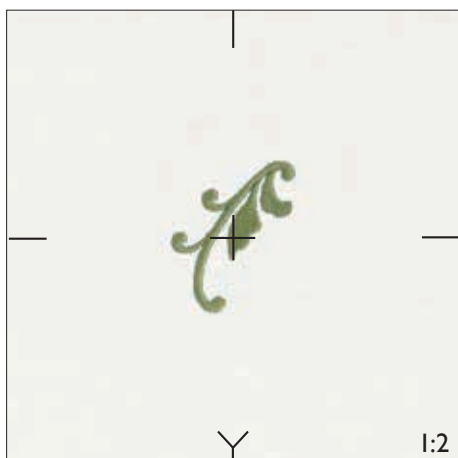

46

Stitches: 12 771
Height: 237 mm
Width: 116 mm

1  1216
2205
2  1005
2296

Gütermann Sulky
Robison - Anton

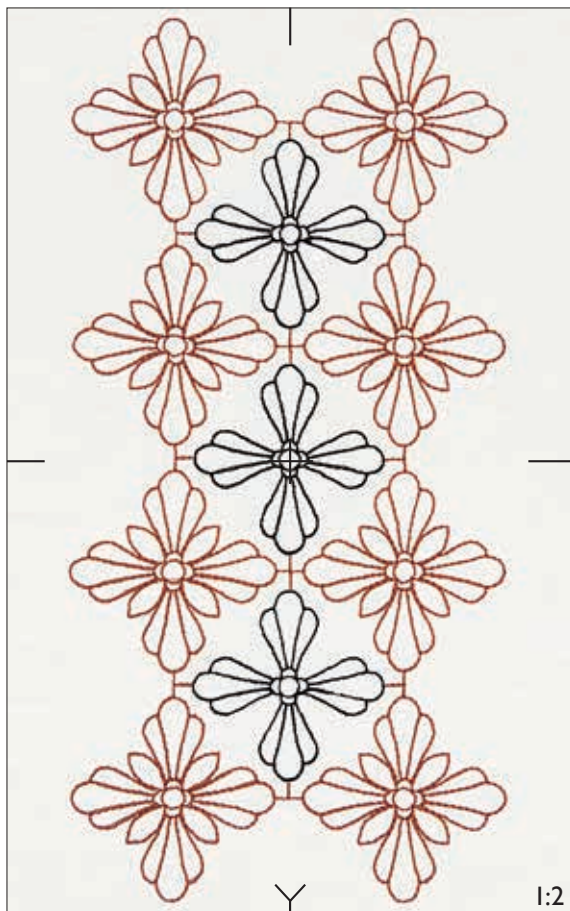

47

Stitches: 1 317
Height: 54 mm
Width: 54 mm

1  1216
2205

Gütermann Sulky
Robison - Anton

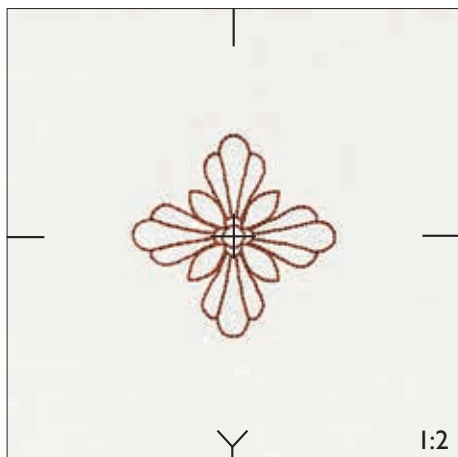

48

Stitches: 994
Height: 51 mm
Width: 51 mm

1  1005
2296

Gütermann Sulky
Robison - Anton

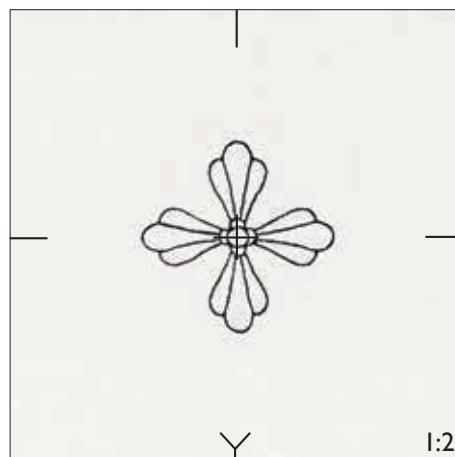

49

Stiches: 14 145
Height: 239 mm
Width: 144 mm

1 ■ 1169
2249

Gütermann Sulky
Robison - Anton

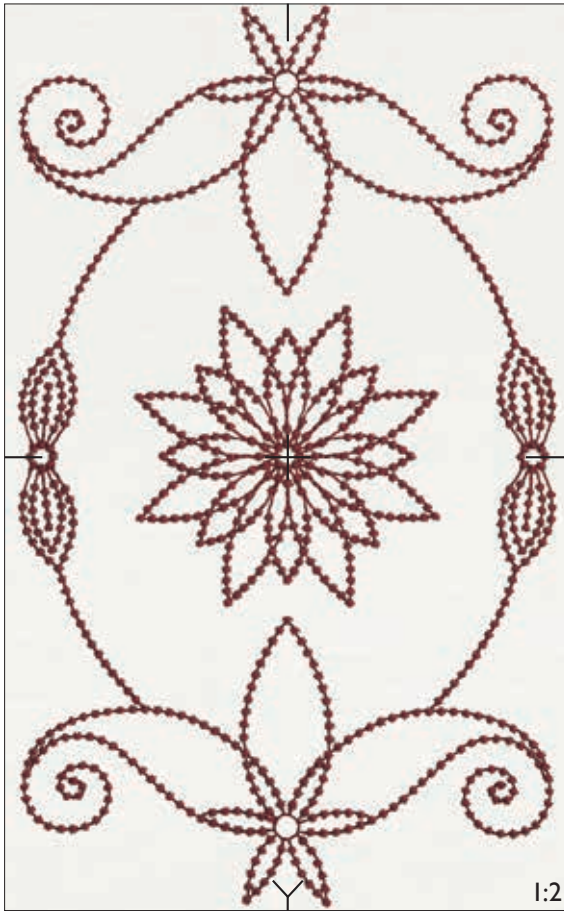

50

Stiches: 6 377
Height: 111 mm
Width: 111 mm

1 ■ 1169
2249

Gütermann Sulky
Robison - Anton

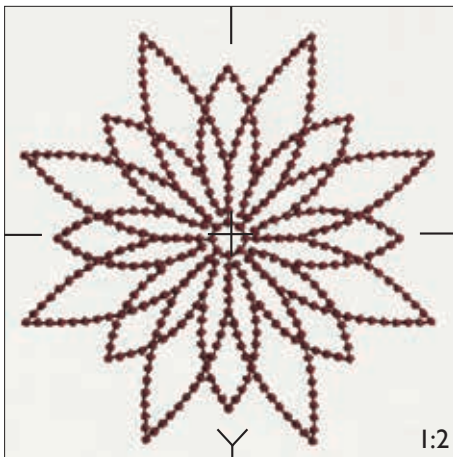

51

Stiches: 5 086
Height: 114 mm
Width: 114 mm

1 ■ 1169
2249

Gütermann Sulky
Robison - Anton

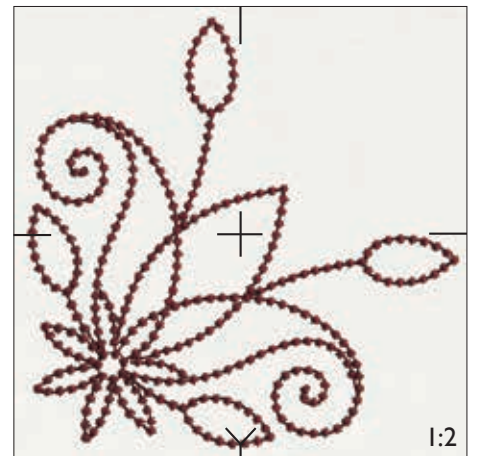

52

Stitches: 20 502
Height: 207 mm
Width: 150 mm

1 ■ 1202
2534

Gütermann Sulky
Robison - Anton

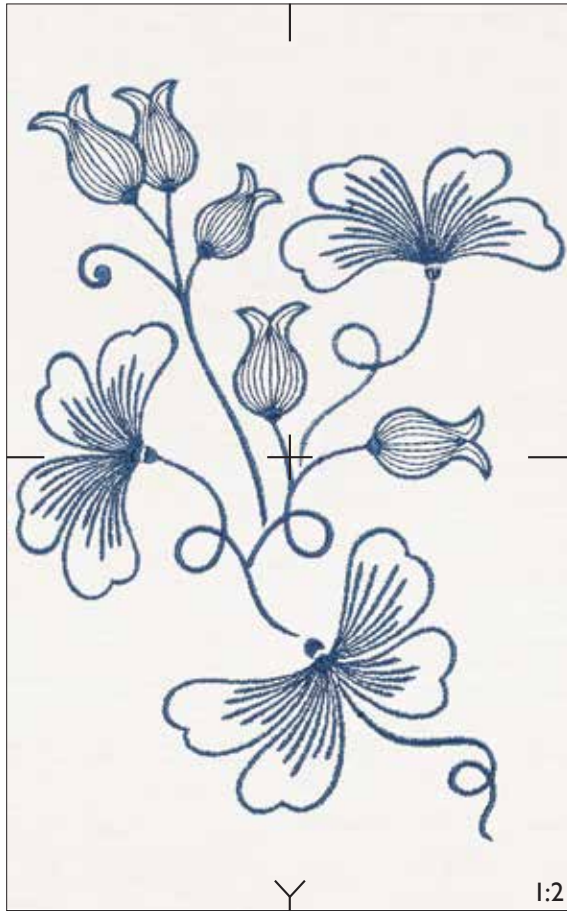

53

Stitches: 9 305
Height: 109 mm
Width: 115 mm

1 ■ 1202
2534

Gütermann Sulky
Robison - Anton

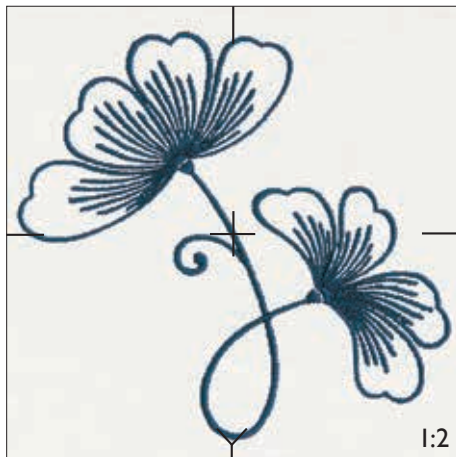

54

Stitches: 5 658
Height: 109 mm
Width: 115 mm

1 ■ 1202
2534

Gütermann Sulky
Robison - Anton

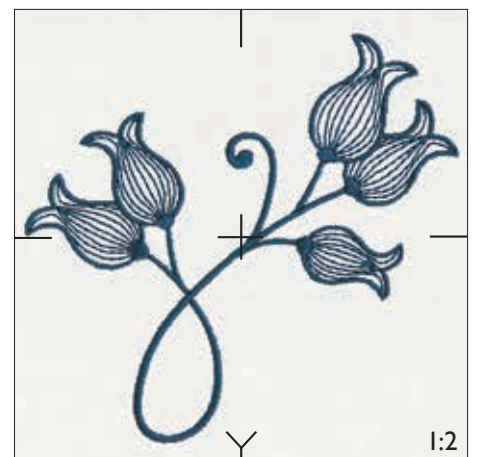

55

Stiches: 9 398
Height: 198 mm
Width: 137 mm





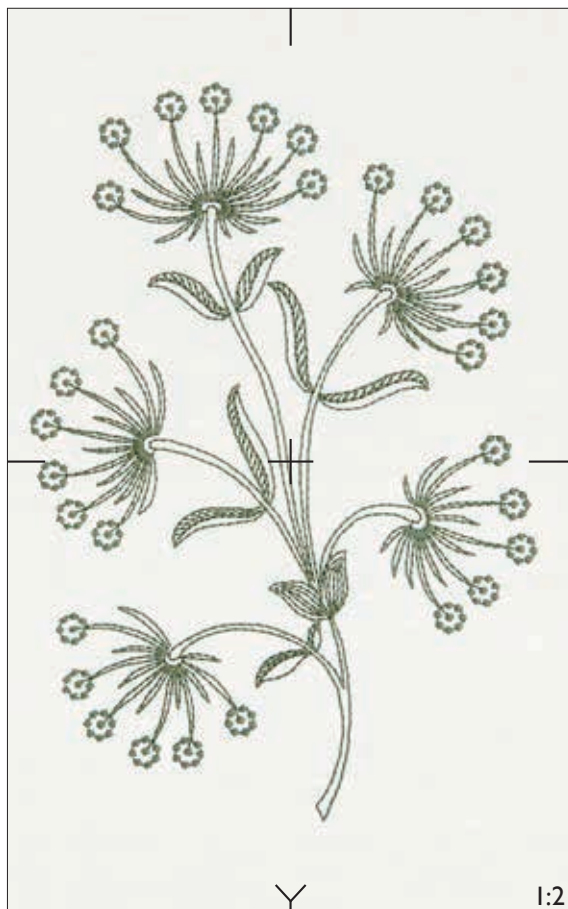



1  1211
2317

Gütermann Sulky
Robison - Anton



56

Stiches: 16 515
Height: 177 mm
Width: 88 mm





- 1  1111
2285
- 2  1254
2286
- 3  1212
2729
- 4  1297
2265
- 5  1167
2234
- 6  1080
2588
- 7  1031
2340
- 8  1193
2482
- 9  1111
2285

Gütermann Sulky
Robison - Anton



57

Stitches: 6 025
Height: 175 mm
Width: 108 mm

- 1  1165
2283
- 2  1327
2539
- 3  1002
2574
- 4  1120
2582

Gütermann Sulky
Robison - Anton

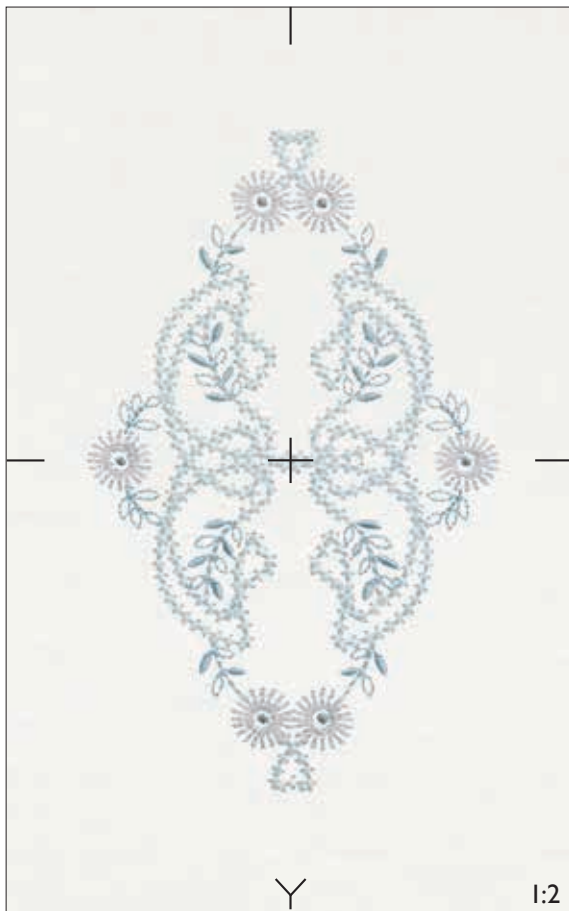

156 Sensational Needle Effects, design #8

58

Stitches: 3 287
Height: 168 mm
Width: 53 mm

- 1  1021
2289

Gütermann Sulky
Robison - Anton

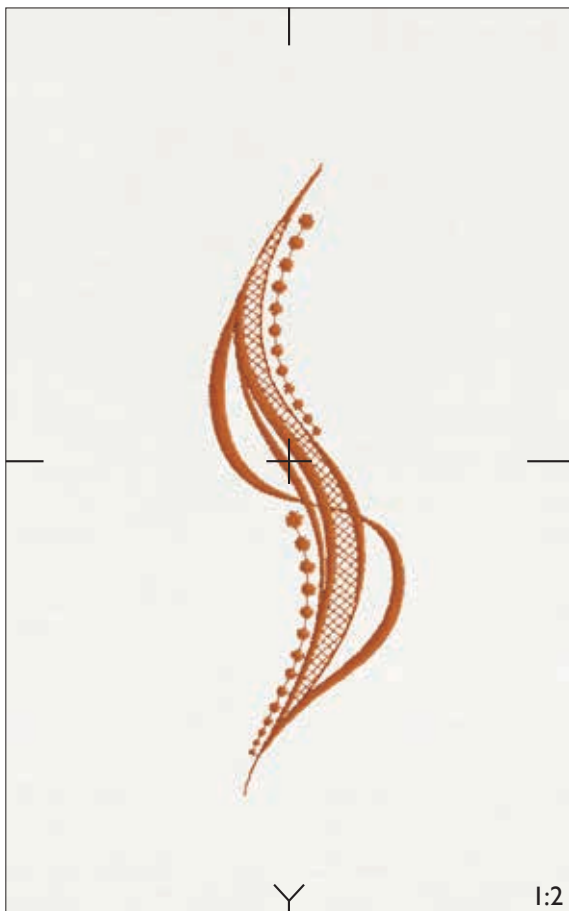

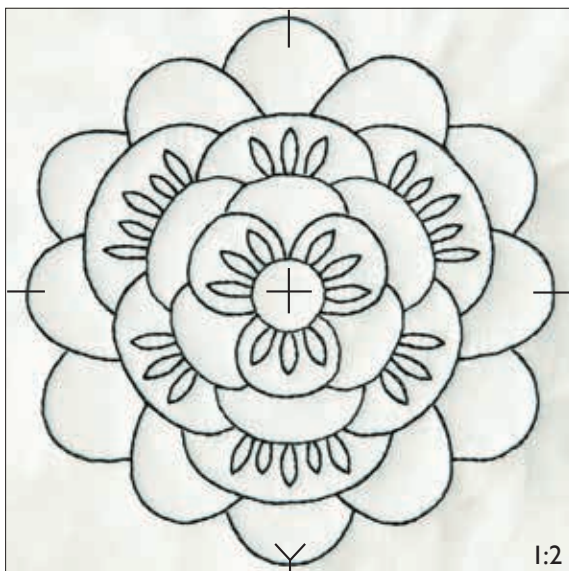

1:2

59

Stitches: 3 634
Height: 145 mm
Width: 139 mm

1 ■ 1234
2296

Gütermann Sulky
Robison - Anton

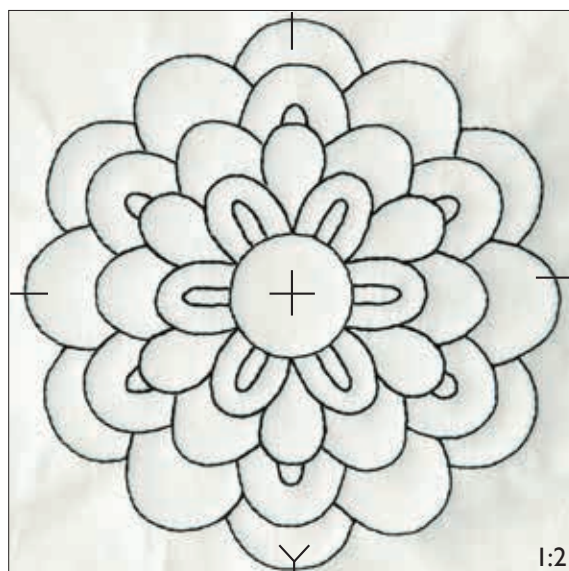

1:2

60

Stitches: 2 889
Height: 145 mm
Width: 141 mm

1 ■ 1234
2296

Gütermann Sulky
Robison - Anton

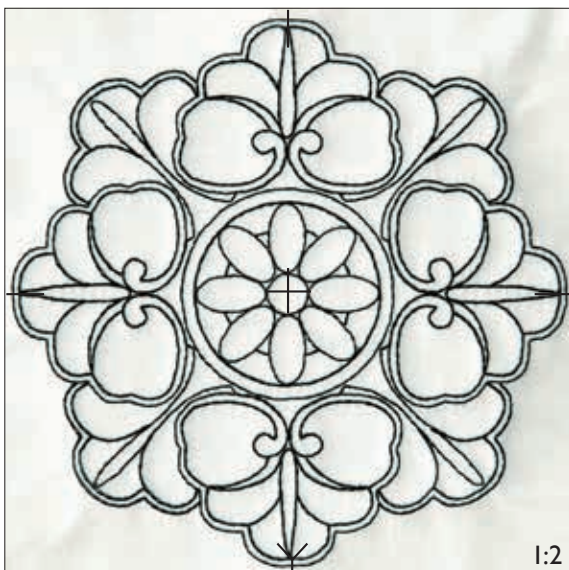

1:2

61

Stitches: 6 269
Height: 145 mm
Width: 145 mm

1 ■ 1234
2296

Gütermann Sulky
Robison - Anton

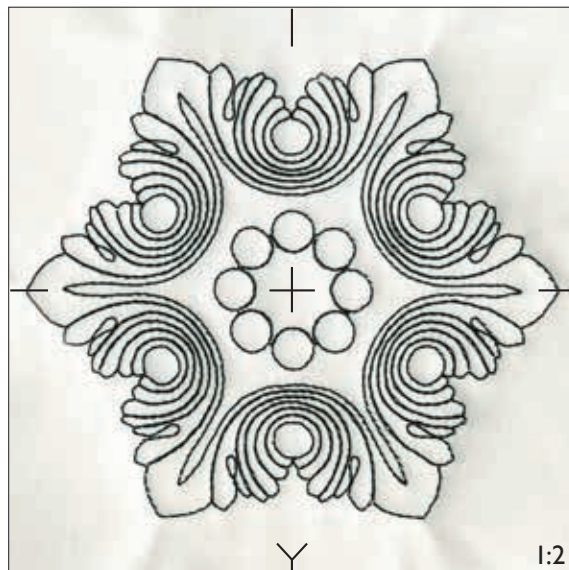

1:2

62

Stitches: 6 145
Height: 126 mm
Width: 145 mm

1 ■ 1234
2296

Gütermann Sulky
Robison - Anton

63

Stitches: 8 563
Height: 115 mm
Width: 115 mm

1  1104
2282

Gütermann Sulky
Robison - Anton

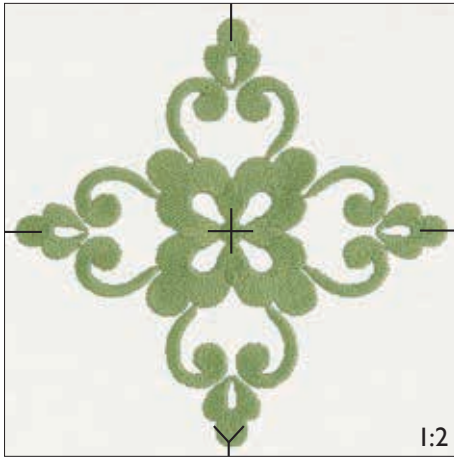

64

Stitches: 11 510
Height: 116 mm
Width: 102 mm

1  1104
2282

Gütermann Sulky
Robison - Anton

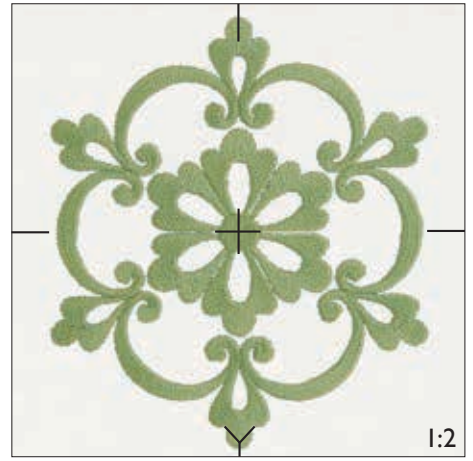

65

Stitches: 4 574
Height: 103 mm
Width: 114 mm

1  1169
2249

Gütermann Sulky
Robison - Anton

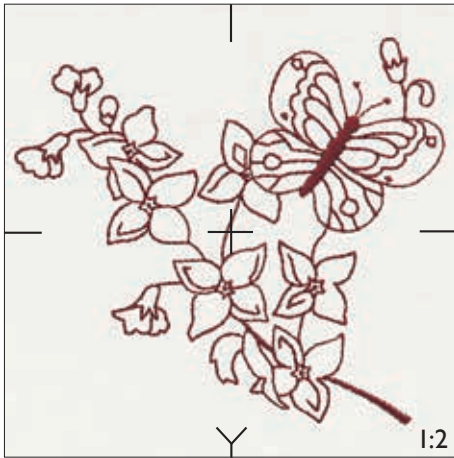

66

Stitches: 7 364
Height: 105 mm
Width: 105 mm

1  1076
2528

2  1039
2508

3  1185
2466

Gütermann Sulky
Robison - Anton

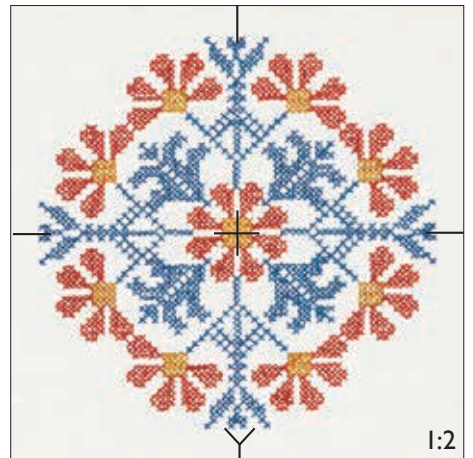

67

Stitches: 2 003
Height: 165 mm
Width: 30 mm

1  1028
2206

Gütermann Sulky
Robison - Anton

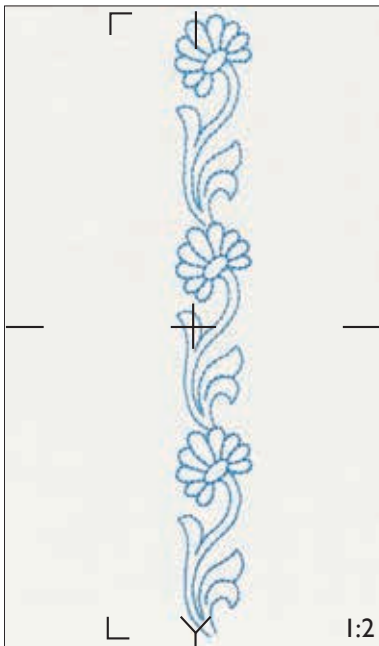
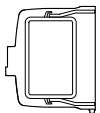

68

Stitches: 4 256
Height: 159 mm
Width: 50 mm

1  1076
2528

Gütermann Sulky
Robison - Anton

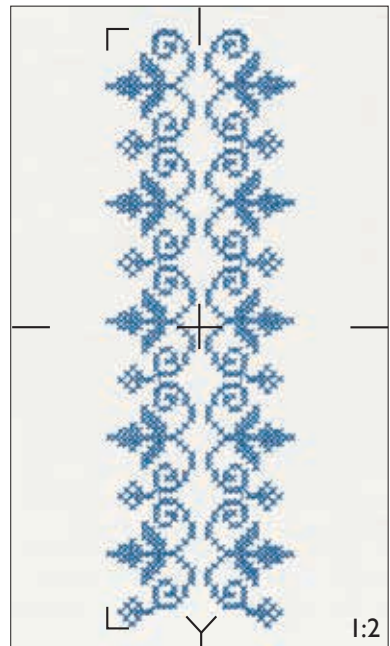
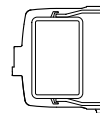

69

Stitches: 9 129
Height: 166 mm
Width: 12 mm

- 1 ■ 1263
2263
- 2 ■ 1117
2374
- 3 ■ 1238
2409

Gütermann Sulky
Robison - Anton

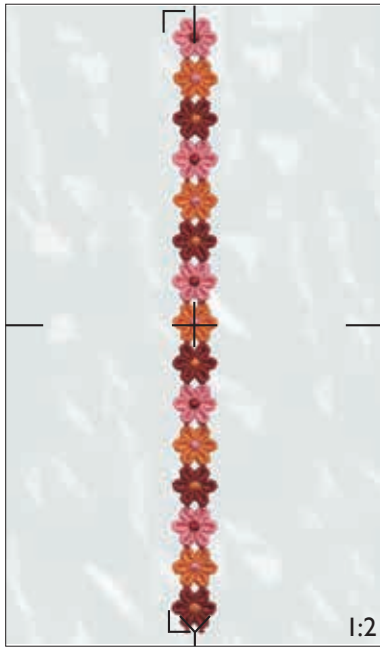

65 Delicate & Dainty, design #2



70

Stitches: 12 751
Height: 160 mm
Width: 39 mm

- 1 ■ 1017
2413
- Step 1 2 ■ 1017
2413
- Step 2 3 ■ 1017
2413

Gütermann Sulky
Robison - Anton

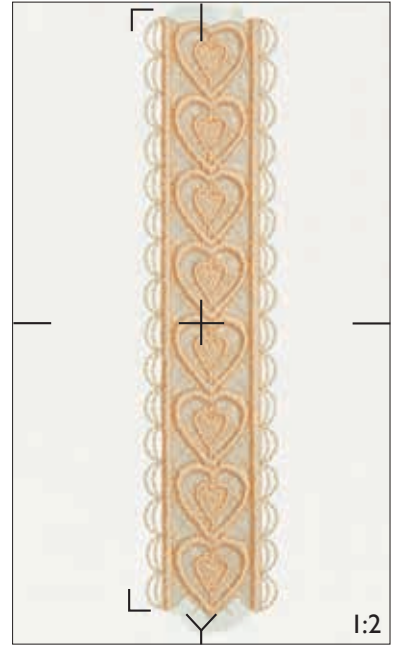

91 Endless Insertions & Thread Work, design #9



71

Stitches: 19 709
Height: 93 mm
Width: 96 mm

- 1 ■ 1327
2340

Gütermann Sulky
Robison - Anton

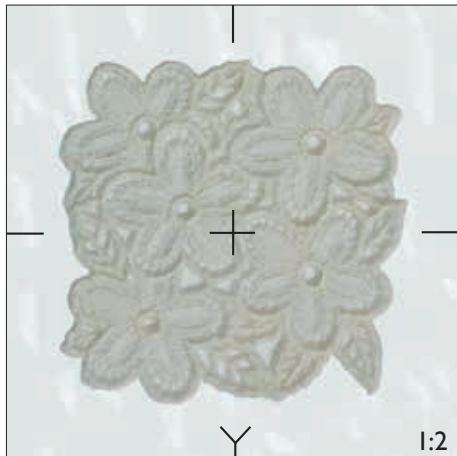

166 Vintage Lace, design #15



72

Stitches: 16 878
Height: 109 mm
Width: 109 mm

- 1 ■ 1236
2537
- * 2 ■ 1236
2537
- 3 ■ 1236
2537

Gütermann Sulky
Robison - Anton

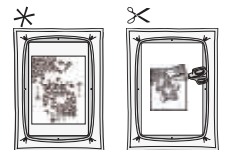
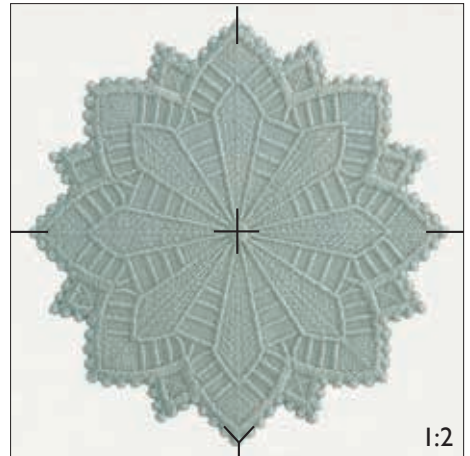

73

Stitches: 9 241
Height: 81 mm
Width: 93 mm

- 1 1226
2614
- 2 1193
2482
- 3 1194
2288
- 4 1205
2624
- 5 1251
2730
- 6 1095
2306
- 7 1513
2446
- 8 1252
2730
- 9 1104
2547
- 10 1177
2457

Gütermann Sulky
Robison - Anton

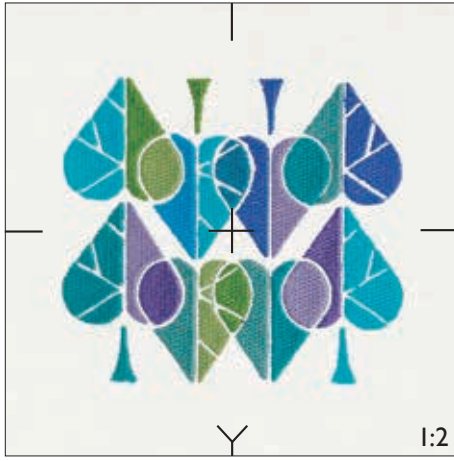

74

Stitches: 6 773
Height: 116 mm
Width: 115 mm

- 1 1028
2206
- 2 1076
2528
- 3 1111
2285
- 4 1193
2482
- 5 1194
2288
- 6 1104
2547
- 7 1047
2238
- 8 1517
2449
- 9 1001
2343

Gütermann Sulky
Robison - Anton

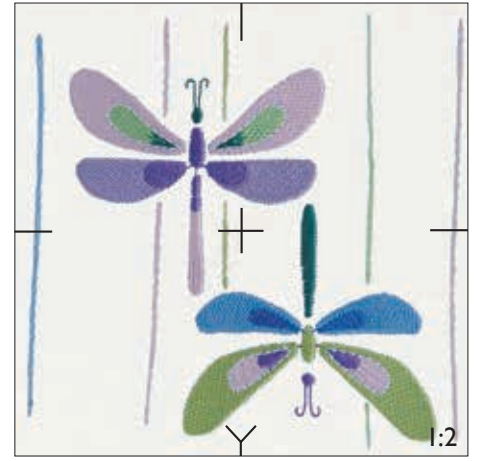

75

Stitches: 11 512
Height: 98 mm
Width: 106 mm

- 1 1104
2547
- 2 1177
2457
- 3 1002
2574
- 4 1117
2276
- 5 1119
2591
- 6 1165
2283
- 7 1023
2560

Gütermann Sulky
Robison - Anton



76

Stitches: 10 763
Height: 106 mm
Width: 114 mm

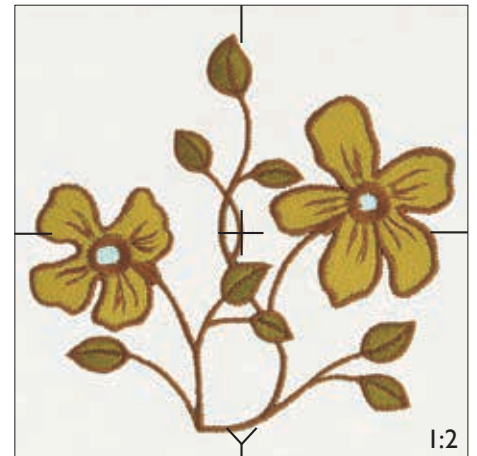

- 1 1001
2343
- 2 1167
2234
- 3 1227
2546
- 4 1056
2569

Gütermann Sulky
Robison - Anton



77

Stitches: 6 648
 Height: 104 mm
 Width: 98 mm

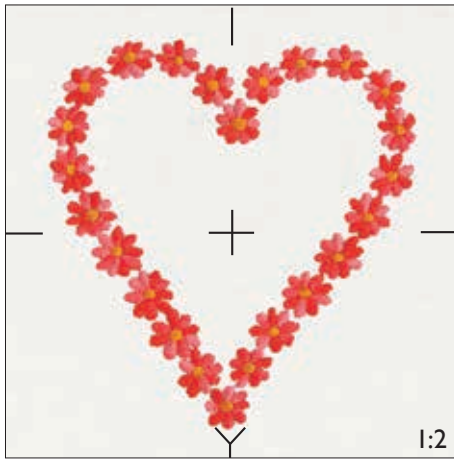

- 1  2102
2344
- 2  1137
2331

Gütermann Sulky
 Robison - Anton



78

Stitches: 12 525
 Height: 115 mm
 Width: 85 mm

- 1  1023
2560
- 2  1071
2574
- 3  1255
2628

Gütermann Sulky
 Robison - Anton

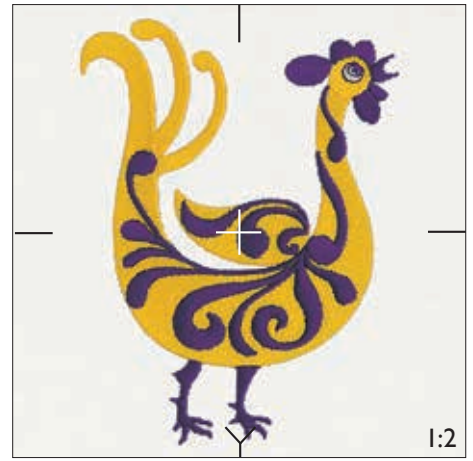

79

Stitches: 4 013
 Height: 154 mm
 Width: 62 mm



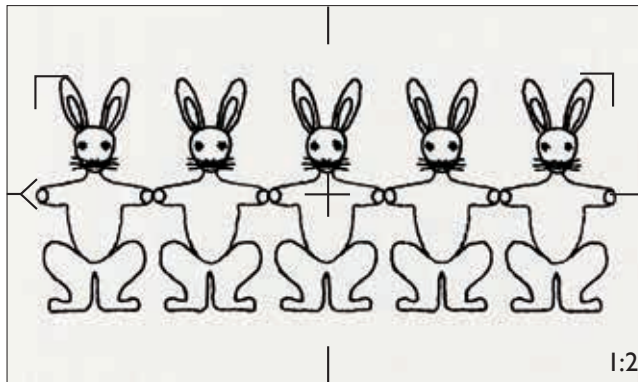
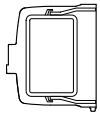

- 1  1234
2296

Gütermann Sulky
 Robison - Anton



80

Stitches: 8 819
 Height: 165 mm
 Width: 40 mm



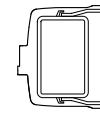
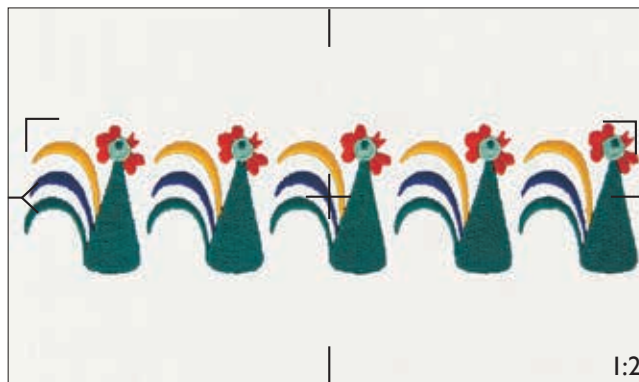

- 1  1137
2331
- 2  1195
2428
- 3  1039
2508
- 4  1207
2278
- 5  1232
2315

Gütermann Sulky
 Robison - Anton



81

Stitches: 7 459
Height: 62 mm
Width: 80 mm



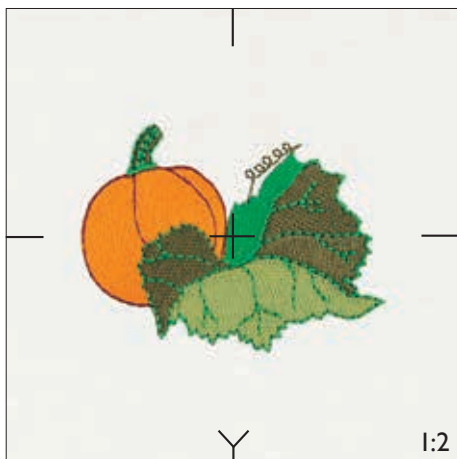

- 1  1238
2409
- 2  1169
2249
- 3  1228
2477
- 4  1104
2547
- 5  1049
2214

Gütermann Sulky
Robison - Anton



82

Stitches: 2 656
Height: 76 mm
Width: 72 mm

- 1  1234
2296
- 2  1011
2618
- 3  7011
2231
- 4  1021
2289



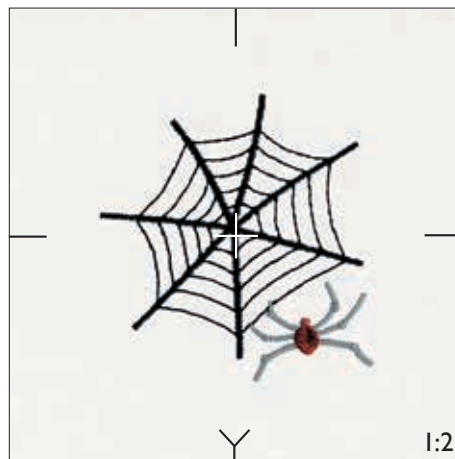

Gütermann Sulky
Robison - Anton

⌘ Thread Velvet™



83

Stitches: 7 621
Height: 110 mm
Width: 111 mm



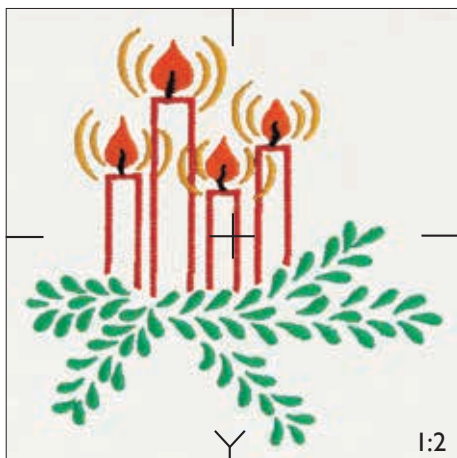

- 1  1168
2328
- 2  1059
2576
- 3  1147
2263
- 4  1185
2466
- 5  1101
2390

Gütermann Sulky
Robison - Anton



84

Stitches: 10 871
Height: 106 mm
Width: 111 mm

- 1  1232
2315
- 2  1147
2263
- 3  1025
2400
- 4  1011
2618

Gütermann Sulky
Robison - Anton

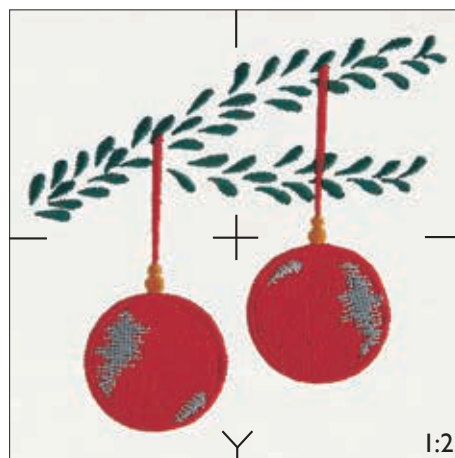

85

Stitches: 9 832
Height: 102 mm
Width: 110 mm



- | | | | | | | | | |
|---|--|--------------|----|--|--------------|------------------------------------|--|--------------|
| 1 | | 1001
2343 | 6 | | 1001
2343 | 11 | | 1005
2296 |
| 2 | | 1011
2618 | 7 | | 1005
2296 | 12 | | 1238
2409 |
| 3 | | 1025
2400 | 8 | | 1049
2214 | 13 | | 1147
2263 |
| 4 | | 1001
2343 | 9 | | 1005
2296 | Gütermann Sulky
Robison - Anton | | |
| * | | 1001
2343 | 10 | | 1220
2217 | | | |
| ✂ | | | | | | | | |

86

Stitches: 9 400
Height: 116 mm
Width: 97 mm

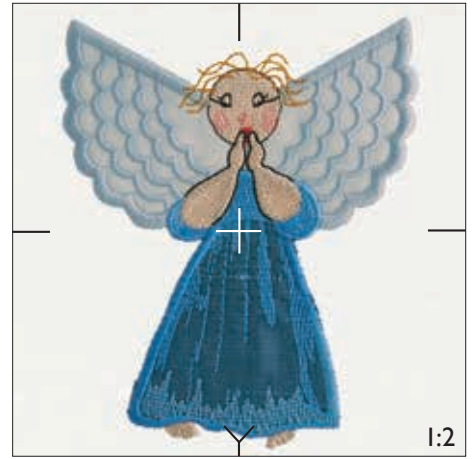

- | | | | | | | | | |
|---|--|--------------|----|--|--------------|------------------------------------|--|--------------|
| 1 | | 1165
2283 | 6 | | 1028
2206 | 11 | | 1017
2413 |
| * | | | ✂ | | | 12 | | 1130
2563 |
| 2 | | 1165
2283 | 7 | | 1028
2206 | 13 | | 1025
2400 |
| ✂ | | | 8 | | 1196
2433 | Gütermann Sulky
Robison - Anton | | |
| 3 | | 1165
2283 | 9 | | 1037
2420 | | | |
| 4 | | 1017
2413 | 10 | | 1016
2374 | | | |
| 5 | | 1028
2206 | | | | | | |
| * | | | | | | | | |

87

Stitches: 13 701
Height: 102 mm
Width: 114 mm



- | | | | | | | | | |
|---|--|--------------|----|--|--------------|------------------------------------|--|--------------|
| 1 | | 1059
2576 | 6 | | 1017
2413 | 11 | | 1025
2400 |
| 2 | | 1147
2263 | 7 | | 1001
2343 | 12 | | 1147
2263 |
| 3 | | 1503
2514 | 8 | | 1128
2273 | 13 | | 1001
2343 |
| 4 | | 1025
2400 | 9 | | 1070
2557 | 14 | | 1166
2265 |
| 5 | | 1147
2263 | 10 | | 1166
2265 | Gütermann Sulky
Robison - Anton | | |

88

Stitches: 14 435
Height: 110 mm
Width: 114 mm



- | | | | | | | | | |
|---|--|--------------|---|--|--------------|------------------------------------|--|--------------|
| 1 | | 1128
2273 | 5 | | 1166
2265 | 9 | | 1166
2265 |
| 2 | | 1170
2402 | 6 | | 1147
2263 | 10 | | 1170
2402 |
| 3 | | 1001
2343 | 7 | | 1017
2413 | 11 | | 1025
2400 |
| 4 | | 1147
2263 | 8 | | 1001
2343 | Gütermann Sulky
Robison - Anton | | |

89

Stitches: 3 516
Height: 70 mm
Width: 41 mm

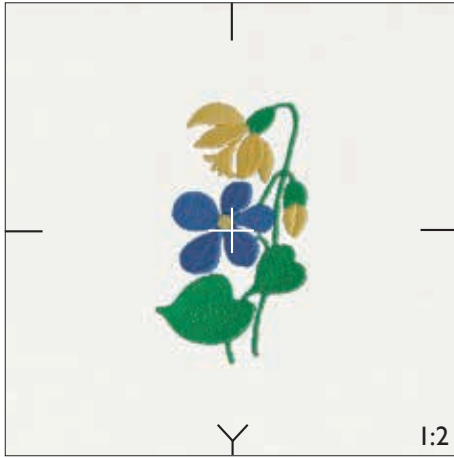

- 1 1049
2214
- 2 1226
2614
- 3 1135
2234

Gütermann Sulky
Robison - Anton

90

Stitches: 6 855
Height: 84 mm
Width: 59 mm



- 1 1001
2343
- 2 1017
2413
- 3 1135
2234
- 4 1239
2394
- 5 1037
2420
- 6 1154
2412
- 7 1220
2217
- 8 1224
2237
- 9 1191
2590
- 10 1196
2433
- 11 1177
2457

Gütermann Sulky
Robison - Anton

91

Stitches: 14 956
Height: 99 mm
Width: 109 mm

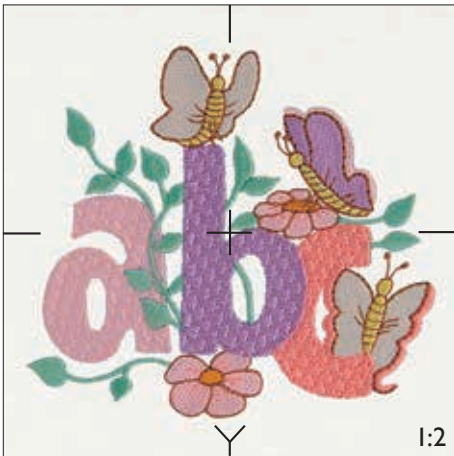

- 1 1047
2238
- 2 1120
2582
- 3 1121
2599
- 4 1047
2238
- 5 1117
2374
- 6 1025
2400
- 7 1080
2588
- 8 1135
2234
- 9 1056
2569

Gütermann Sulky
Robison - Anton

92

Stitches: 20 029
Height: 100 mm
Width: 90 mm





- 1 1198
2275
- 2 1028
2206
- 3 1251
2730
- 4 1190
2611
- 5 1001
2343
- 6 1135
2234
- 7 1251
2730
- 8 1190
2611
- 9 1237
2608
- 10 1049
2214
- 11 1220
2217
- 12 1028
2206
- 13 1076
2528
- 14 1135
2234
- 15 1190
2611
- 16 1237
2608
- 17 1028
2206
- 18 1251
2730

Gütermann Sulky
Robison - Anton

93

Stiches: 4 128
 Height: 45 mm
 Width: 66 mm



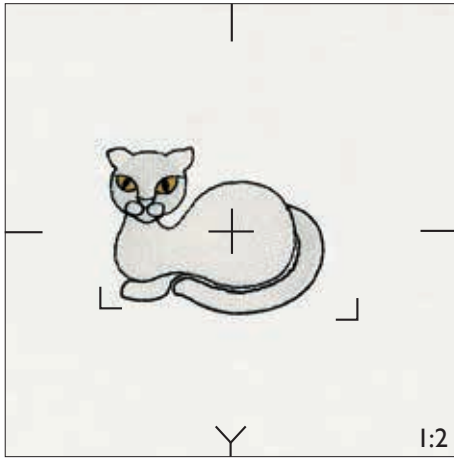

- 1  1001
2343
- 2  1227
2562
- 3  1005
2296

Gütermann Sulky
 Robison - Anton



94

Stiches: 4 440
 Height: 45 mm
 Width: 58 mm





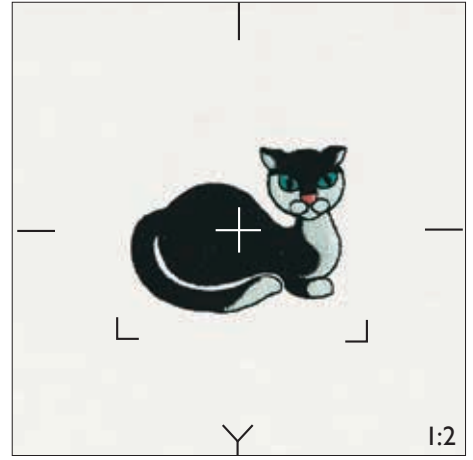



- 1  1001
2343
- 2  1513
2446
- 3  1020
2414
- 4  1005
2296

Gütermann Sulky
 Robison - Anton



95

Stiches: 14 301
 Height: 74 mm
 Width: 109 mm





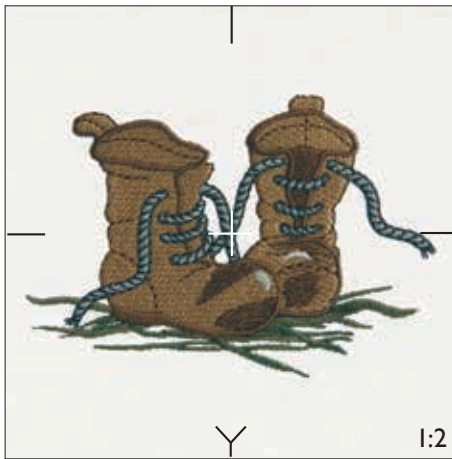



- 1  1228
2477
- 2  1212
2729
- 3  1149
2593
- 4  1128
2273
- 5  1170
2402
- 6  1011
2618
- 7  1220
2217
- 8  1071
2574

Gütermann Sulky
 Robison - Anton



96

Stiches: 4 419
 Height: 71 mm
 Width: 43 mm

- 1  1177
2738
- 2  1051
2580
- 3  1248
2388
- 4  1002
2343
- 5  1067
2316
- 6  1124
2235
- 7  1039
2467
- 8  1005
2215



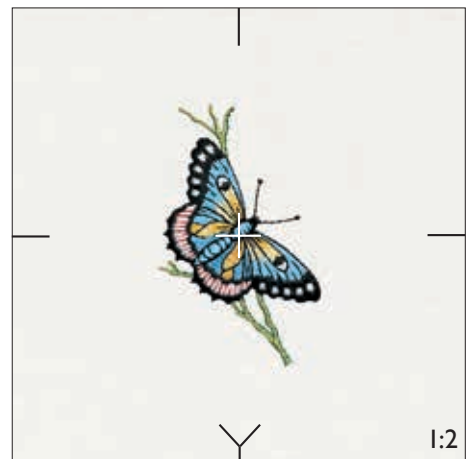

Gütermann Sulky
 Robison - Anton



47 Butterflies, design #17

97

Stiches: 4 181
 Height: 38 mm
 Width: 92 mm

- 1  1081
2480
- 2  1198
2341
- 3  1248
2239
- 4  1234
2296

Gütermann Sulky
 Robison - Anton

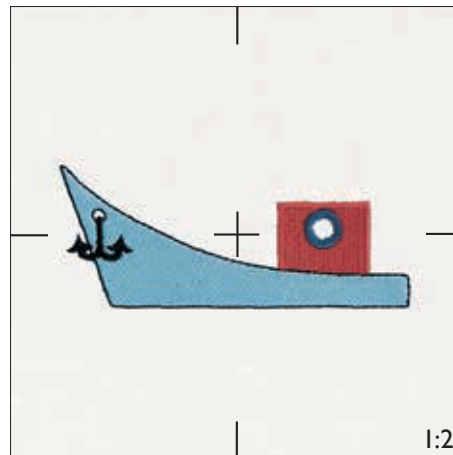

98

Stiches: 5 195
Height: 95 mm
Width: 63 mm

- 1 1071
2574
- 2 1236
2582
- 3 1011
2618
- 4 1166
2265

Gütermann Sulky
Robison - Anton

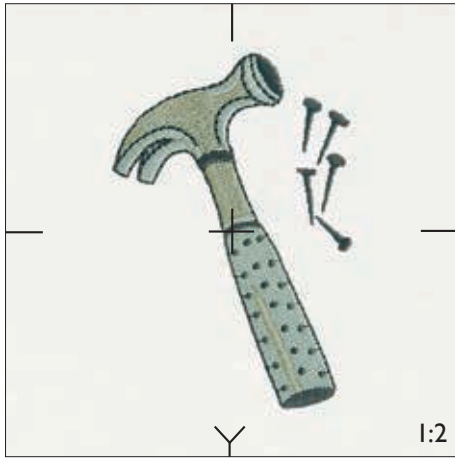

99

Stiches: 6 397
Height: 98 mm
Width: 77 mm

- 1 1071
2574
- 2 1011
2618
- 3 1166
2265
- 4 1128
2273
- 5 1179
2729

Gütermann Sulky
Robison - Anton

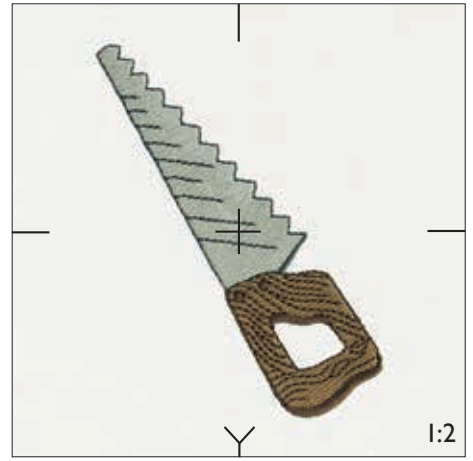

100

Stiches: 5 827
Height: 105 mm
Width: 77 mm

- 1 1002
2574
- 2 1011
2618
- 3 1128
2273
- 4 1239
2394
- 5 1166
2265
- 6 1057
2251

Gütermann Sulky
Robison - Anton

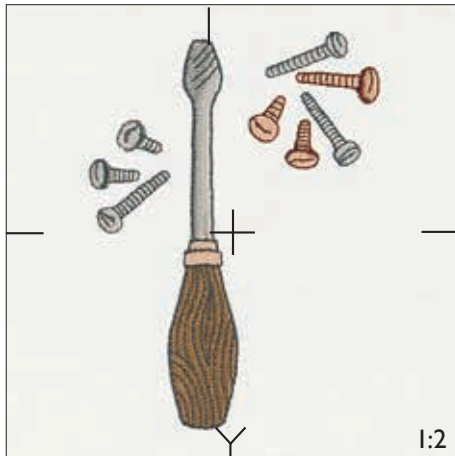

Clarendon

30 mm 1.2 inch

A B a b 1 2

Clarendon

20 mm 0.8 inch

A a 1 2

Clarendon

12 mm 0.5 inch

A B C D E
a b c 1 2 3



www.myembroideries.com
www.husqvarnaviking.com