



View this machine and more at:

<https://www.thesewingstudio.co.uk>

# Operation Manual

## Sewing Machine

Product Code: 888-F50/F52/F60/F62/F70/F72

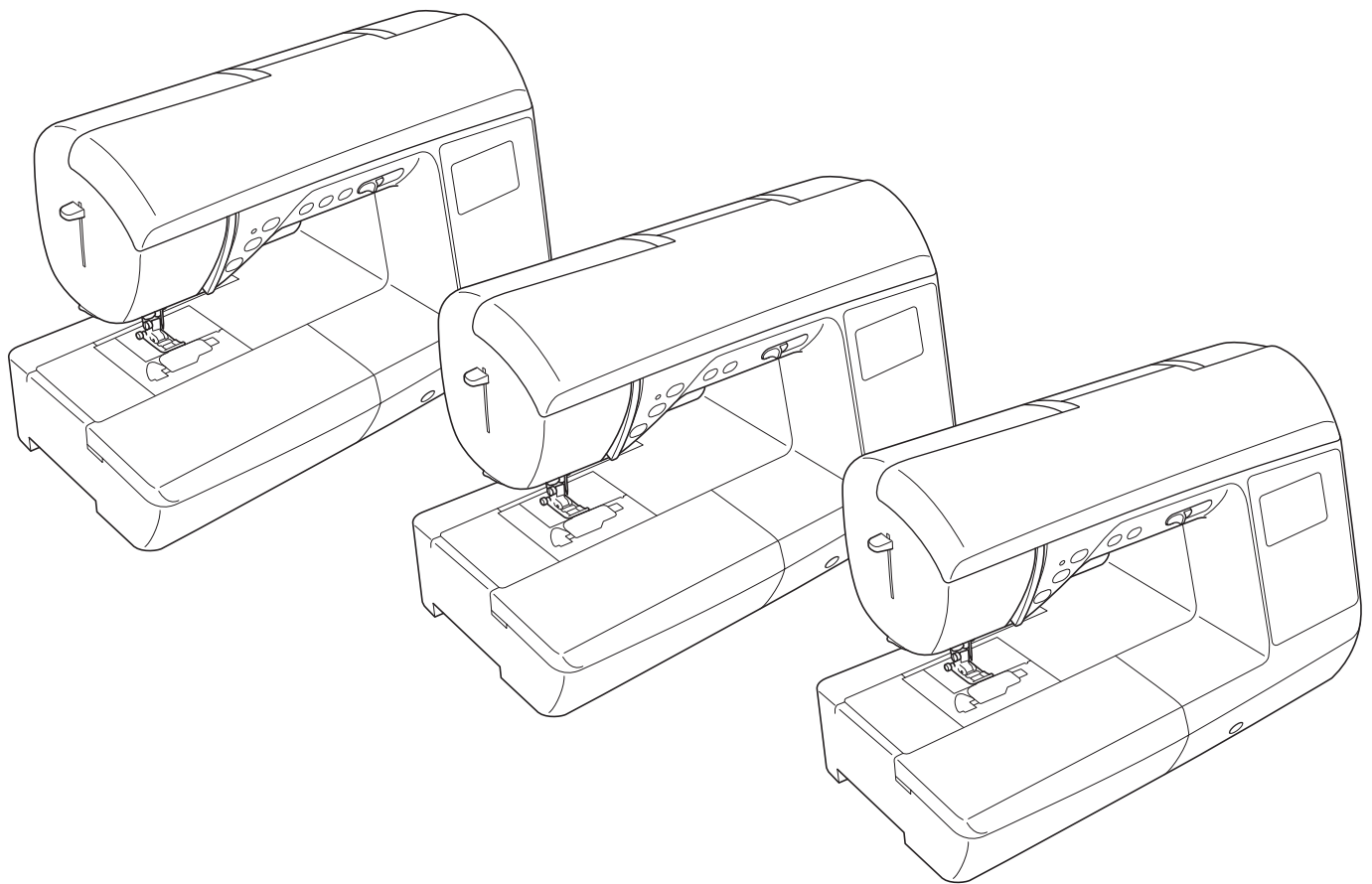

Be sure to read this document before using the machine.  
We recommend that you keep this document nearby for future reference.



## INTRODUCTION

Thank you for purchasing this machine. Before using this machine, carefully read the “IMPORTANT SAFETY INSTRUCTIONS”, and then study this manual for the correct operation of the various functions. In addition, after you have finished reading this manual, store it where it can quickly be accessed for future reference.

## IMPORTANT SAFETY INSTRUCTIONS

Please read these safety instructions before attempting to use the machine.

### **⚠ DANGER** - To reduce the risk of electrical shock

- 1** Always unplug the machine from the electrical outlet immediately after using, when cleaning, making any user servicing adjustments mentioned in this manual, or if you are leaving the machine unattended.

### **⚠ WARNING** - To reduce the risk of burns, fire, electrical shock, or injury to persons.

- 2** Always unplug the machine from the electrical outlet when making any adjustments mentioned in the instruction manual.

- To unplug the machine, switch the machine to the symbol “O” position to turn it off, then grasp the plug and pull it out of the electrical outlet. Do not pull on the cord.
- Plug the machine directly into the electrical outlet. Do not use an extension cord.
- Always unplug your machine if there is a power failure.

### **3** Electrical Hazards:

- This machine should be connected to an AC power source within the range indicated on the rating label. Do not connect it to a DC power source or converter. If you are not sure what kind of power source you have, contact a qualified electrician.
- This machine is approved for use in the country of purchase only.

- 4** Never operate this machine if it has a damaged cord or plug, if it is not working properly, has been dropped or damaged, or water is spilled on the unit. Return the machine to the nearest authorized Brother dealer for examination, repair, electrical or mechanical adjustment.

- While the machine is stored or in use if you notice anything unusual, such as an odor, heat, discoloration or deformation, stop using the machine immediately and unplug the power cord.
- When transporting the machine, be sure to carry it by its handle. Lifting the machine by any other part may damage the machine or result in the machine falling, which could cause injuries.
- When lifting the machine, be careful not to make any sudden or careless movements, which may cause a personal injury.

## 5 Always keep your work area clear:

- Never operate the machine with any air openings blocked. Keep ventilation openings of the machine and foot control free from the build up of lint, dust, and loose cloth.
- Do not store objects on the foot controller.
- Do not use extension cords. Plug the machine directly into the electrical outlet.
- Never drop or insert foreign objects in any opening.
- Do not operate where aerosol (spray) products are being used or where oxygen is being administered.
- Do not use the machine near a heat source, such as a stove or iron; otherwise, the machine, power cord or garment being sewn may ignite, resulting in fire or an electric shock.
- Do not place this machine on an unstable surface, such as an unsteady or slanted table, otherwise the machine may fall, resulting in injuries.

## 6 Special care is required when sewing:

- Always pay close attention to the needle. Do not use bent or damaged needles.
- Keep fingers away from all moving parts. Special care is required around the machine needle.
- Switch the machine to the symbol "O" position to turn it off when making any adjustments in the needle area.
- Do not use a damaged or incorrect needle plate, as it could cause the needle to break.
- Do not push or pull the fabric when sewing, and follow careful instruction when free motion stitching so that you do not deflect the needle and cause it to break.

## 7 This machine is not a toy:

- Your close attention is necessary when the machine is used by or near children.
- The plastic bag that this machine was supplied in should be kept out of the reach of children or disposed of. Never allow children to play with the bag due to the danger of suffocation.
- Do not use outdoors.

## 8 For a longer service life:

- When storing this machine, avoid direct sunlight and high humidity locations. Do not use or store the machine near a space heater, iron, halogen lamp, or other hot objects.
- Use only neutral soaps or detergents to clean the case. Benzene, thinner, and scouring powders can damage the case and machine, and should never be used.
- Always consult the Operation Manual when replacing or installing any assemblies, the presser feet, needle, or other parts to assure correct installation.

## 9 For repair or adjustment:

- If the light unit is damaged, it must be replaced by an authorized Brother dealer.
- In the event a malfunction occurs or adjustment is required, first follow the troubleshooting table in the back of the Operation Manual to inspect and adjust the machine yourself. If the problem persists, please consult your local authorized Brother dealer.

**Use this machine only for its intended use as described in the manual.**

**Use accessories recommended by the manufacturer as contained in this manual.**

**The contents of this manual and specifications of this product are subject to change without notice.**

**For additional product information, visit our website at [www.brother.com](http://www.brother.com)**

# SAVE THESE INSTRUCTIONS

## This machine is intended for household use.

### FOR USERS IN COUNTRIES EXCEPT EUROPEAN COUNTRIES

This appliance is not intended for use by persons (including children) with reduced physical, sensory or mental capabilities, or lack of experience and knowledge, unless they have been given supervision or instruction concerning use of the appliance by a person responsible for their safety. Children should be supervised to ensure that they do not play with the appliance.

### FOR USERS IN EUROPEAN COUNTRIES

This appliance can be used by children aged from 8 years and above and persons with reduced physical, sensory or mental capabilities or lack of experience and knowledge if they have been given supervision or instruction concerning use of the appliance in a safe way and understand the hazards involved. Children shall not play with the appliance. Cleaning and user maintenance shall not be made by children without supervision.

## FOR USERS IN THE UK, EIRE, MALTA AND CYPRUS ONLY

### IMPORTANT

- In the event of replacing the plug fuse, use a fuse approved by ASTA to BS 1362, i.e. carrying the  mark, rating as marked on plug.
- Always replace the fuse cover. Never use plugs with the fuse cover omitted.
- If the available electrical outlet is not suitable for the plug supplied with this equipment, you should contact your authorized Brother dealer to obtain the correct lead.

## ABOUT THIS MANUAL

This manual was written for several machine models.

The machine models are categorized according to their specifications and referred to as “Model” followed by a number. Refer to the Quick Reference Guide for the model of your machine.

The screen displays may differ from the ones displayed on your machine.

Refer to the Quick Reference Guide for details on accessories, settings screen and pre-programmed stitch patterns.

First, read “Functions available with each model” and “Using the utility stitch tables in the “Sewing” section” on page B-8.

## WHAT YOU CAN DO WITH THIS MACHINE

### B Basic operations

After purchasing your machine, be sure to read this section first. This section provides details on the initial setup procedures as well as descriptions of this machine’s more useful functions.

#### Chapter 1 GETTING READY

*Page B-2*

To learn the operation of the principal parts and the screens

#### Chapter 2 STARTING TO SEW

*Page B-33*

To learn how to prepare for sewing and basic sewing operations

### S Sewing

This section describes procedures for using the various utility stitches as well as other functions. It provides details on basic machine sewing in addition to the more expressive features of the machine, such as sewing tubular pieces and buttonholes.

#### Chapter 1 SEWING ATTRACTIVE FINISHES

*Page S-2*

Tips for sewing attractive finishes and various fabrics

#### Chapter 2 UTILITY STITCHES

*Page S-6*

Sew pre-programmed frequently used stitches

### D Decorative sewing

This section provides instructions on sewing character stitches and decorative stitches as well as on adjusting and editing them. In addition, it describes how to use MY CUSTOM STITCH, which allows you to create original stitch patterns.

#### Chapter 1 CHARACTER / DECORATIVE STITCHES

*Page D-2*

The variety of stitches widen your creativity

#### Chapter 2 MY CUSTOM STITCH

*Page D-12*

Create original decorative stitches

### A Appendix

This section provides important information for operating this machine.

#### Chapter 1 MAINTENANCE AND TROUBLESHOOTING

*Page A-2*

The various maintenance and troubleshooting procedures are described.

# CONTENTS

INTRODUCTION .....	i
IMPORTANT SAFETY INSTRUCTIONS .....	i
ABOUT THIS MANUAL .....	iv
WHAT YOU CAN DO WITH THIS MACHINE....	iv

## B Basic operations

### Chapter 1 GETTING READY 2

<b>Names of Machine Parts and Their Functions .....</b>	<b>2</b>
Machine .....	2
Needle and presser foot section .....	3
Operation buttons .....	3
Operation panel and operation keys .....	4
Using the flat bed attachment .....	5
Included accessories .....	6
Optional accessories .....	7
Functions available with each model .....	8
Using the utility stitch tables in the "Sewing" section .....	8
<b>Turning the Machine On/Off.....</b>	<b>9</b>
Turning on the machine .....	10
Turning off the machine .....	10
Select machine setting for the first time .....	10
<b>LCD .....</b>	<b>11</b>
Viewing the LCD .....	11
Settings screen .....	12
Choosing the display language.....	14
Adjusting input sensitivity for operation keys .....	14
<b>Winding/Installing the Bobbin.....</b>	<b>15</b>
Winding the bobbin .....	15
Installing the bobbin .....	18
<b>Upper Threading .....</b>	<b>21</b>
Threading the upper thread.....	21
Threading the needle .....	23
Threading the needle manually (without using the needle threader) .....	24
Pulling up the bobbin thread.....	24
Using the twin needle .....	25
<b>Replacing the Needle .....</b>	<b>28</b>
Fabric/thread/needle combinations .....	28
Checking the needle .....	29
Replacing the needle .....	29
<b>Replacing the Presser Foot .....</b>	<b>31</b>
Replacing the presser foot .....	31
Removing and attaching the presser foot holder .....	32

### Chapter 2 STARTING TO SEW 33

<b>Sewing.....</b>	<b>33</b>
Stitch selection methods .....	33
Selecting a stitch pattern .....	34
Sewing a stitch .....	35
Sewing reinforcement stitches .....	37
Automatic reinforcement stitching .....	37
<b>Setting the Stitch .....</b>	<b>39</b>
Setting the stitch width .....	39
Setting the stitch length .....	39
Setting the thread tension .....	40
Saving stitch settings .....	41
<b>Useful Functions.....</b>	<b>42</b>
Automatically cutting the thread .....	42
Mirroring stitches .....	42
Adjusting the presser foot pressure .....	43
Automatic Fabric Sensor System (Automatic presser foot pressure) .....	43
Pivoting .....	43

Sewing with free motion mode .....	44
Hands-free raising and lifting of the presser foot .....	45
<b>Stitch Setting Chart.....</b>	<b>46</b>

## S Sewing

### Chapter 1 SEWING ATTRACTIVE FINISHES 2

<b>Sewing Tips.....</b>	<b>2</b>
Trial sewing.....	2
Changing the sewing direction.....	2
Sewing curves .....	2
Sewing cylindrical pieces .....	2
Sewing an even seam allowance .....	3
<b>Sewing Various Fabrics .....</b>	<b>4</b>
Sewing thick fabrics .....	4
Sewing thin fabrics .....	4
Sewing stretch fabrics.....	5
Sewing leathers or vinyl fabrics .....	5
Sewing hook-and-loop fastener tape.....	5

### Chapter 2 UTILITY STITCHES 6

<b>Basic Stitching.....</b>	<b>6</b>
Basting .....	6
Basic stitching .....	6
<b>Blind Hem Stitching.....</b>	<b>8</b>
<b>Overcasting Stitches .....</b>	<b>11</b>
Sewing overcasting stitches using overcasting foot "G" .....	11
Sewing overcasting stitches using zigzag foot "J" .....	12
Sewing overcasting stitches using the side cutter (sold separately with some models) .....	12
<b>Buttonhole Stitching/Button Sewing .....</b>	<b>14</b>
Buttonhole sewing.....	14
Button sewing .....	17
<b>Zipper Insertion .....</b>	<b>19</b>
Inserting a centered zipper .....	19
Inserting a side zipper .....	20
<b>Zipper/piping Insertion .....</b>	<b>23</b>
Inserting a centered zipper .....	23
Inserting a piping.....	24
<b>Sewing Stretch Fabrics and Elastic Tape.....</b>	<b>25</b>
Stretch stitching .....	25
Elastic attaching .....	25
<b>Appliqué, Patchwork and Quilt Stitching.....</b>	<b>26</b>
Appliqué stitching .....	26
Patchwork (crazy quilt) stitching.....	27
Piecing.....	27
Quilting.....	29
Free motion quilting .....	30
Satin stitching using the sewing speed controller .....	34
<b>Reinforcement Stitching.....</b>	<b>35</b>
Triple stretch stitching .....	35
Bar tack stitching.....	35
Darning .....	36
<b>Eyelet Stitching .....</b>	<b>38</b>
<b>Attaching Patches or Emblems to Shirt Sleeves ....</b>	<b>39</b>
<b>Decorative Stitching .....</b>	<b>41</b>
Fagoting .....	41
Scallop stitching .....	42
Smocking .....	42
Shell tuck stitching .....	43
Joining.....	43
Heirloom stitching.....	44



# D Decorative sewing

## Chapter 1 CHARACTER / DECORATIVE STITCHES 2

**Sewing the Various Built-in Decorative Patterns .... 2**

- Selecting stitch patterns ..... 2
- Deleting a pattern..... 3
- Sewing attractive finishes ..... 3
- Basic sewing ..... 4
- Combining patterns ..... 5
- Repeating combined patterns ..... 5
- Checking the selected pattern..... 6
- Changing the pattern size ..... 6
- Changing the stitch density..... 6
- Changing the pattern length ..... 7
- Changing character spacing ..... 7
- Creating step stitch patterns ..... 7
- Mirroring a pattern image ..... 8
- Returning to the beginning of the pattern..... 9
- Saving a pattern..... 9
- Retrieving a pattern ..... 10
- Realigning the pattern ..... 10

## Chapter 2 MY CUSTOM STITCH 12

**Designing a Stitch..... 12**

- Drawing a sketch of the pattern ..... 12
- Entering the pattern data..... 12
- Examples of designs ..... 14

# A Appendix

## Chapter 1 MAINTENANCE AND TROUBLESHOOTING 2

**Care and Maintenance..... 2**

- Restrictions on oiling ..... 2
- Precautions on storing the machine ..... 2
- Cleaning the LCD screen ..... 2
- Cleaning the machine surface ..... 2
- Cleaning the race ..... 2

**Troubleshooting..... 4**

- Frequent troubleshooting topics ..... 4
- Upper thread tightened up ..... 4
- Tangled thread on wrong side of fabric ..... 5
- Incorrect thread tension..... 6
- Fabric is caught in the machine and cannot be removed ..... 8
- When the thread became tangled under the bobbin winder seat ..... 10
- List of symptoms..... 12
- Error messages..... 17
- Operation beep ..... 20
- Nothing appears in the LCD ..... 20

**Specifications ..... 20**

**Index ..... 21**

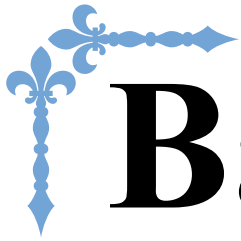

# Basic operations

This section provides details on the initial setup procedures as well as descriptions of this machine's more useful functions.

Page number starts with "B" in this section.

**Chapter1 GETTING READY .....B-2**

---

**Chapter2 STARTING TO SEW .....B-33**

---

# Chapter 1 GETTING READY

## Names of Machine Parts and Their Functions

The names of the various parts of the machine and their functions are described below. Before using the machine, carefully read these descriptions to learn the names of the machine parts and their locations.

### Machine

#### ■ Front view

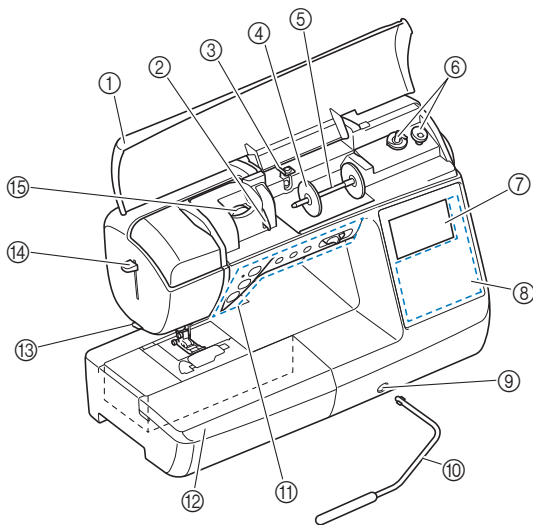

- ① **Top cover**  
Open the top cover to place the spool of thread on the spool pin.
- ② **Thread guide plate**  
Pass the thread around the thread guide plate when threading the upper thread.
- ③ **Bobbin winding thread guide and pretension disk**  
Pass the thread under this thread guide and around the pretension disk when winding the bobbin thread.
- ④ **Spool cap**  
Use the spool cap to hold the spool of thread in place.
- ⑤ **Spool pin**  
Place a spool of thread on the spool pin.
- ⑥ **Bobbin winder**  
Use the bobbin winder when winding the bobbin.
- ⑦ **LCD (liquid crystal display)**  
Settings for the selected stitch and error messages appear in the LCD. (page B-11)
- ⑧ **Operation panel**  
From the operation panel, stitch settings can be selected and edited, and operations for using the machine can be selected (page B-4).
- ⑨ **Knee lifter mounting slot**  
Insert the knee lifter into the knee lifter mounting slot.
- ⑩ **Knee lifter**  
Use the knee lifter to raise and lower the presser foot. (page B-45)
- ⑪ **Operation buttons and sewing speed controller**  
Use these buttons and the slide to operate the machine. (page B-3)
- ⑫ **Flat bed attachment**  
Insert the presser foot accessory tray into the accessory compartment of the flat bed attachment. Remove the flat bed attachment when sewing cylindrical pieces such as sleeve cuffs.

- ⑬ **Thread cutter**  
Pass the threads through the thread cutter to cut them.
- ⑭ **Needle threader lever**  
Use the needle threader lever to thread the needle.
- ⑮ **Thread tension dial**  
**(Equipped on some models. Refer to page B-8)**  
Use the dial to adjust the upper thread tension. (page B-40)

#### ■ Right-side/rear view

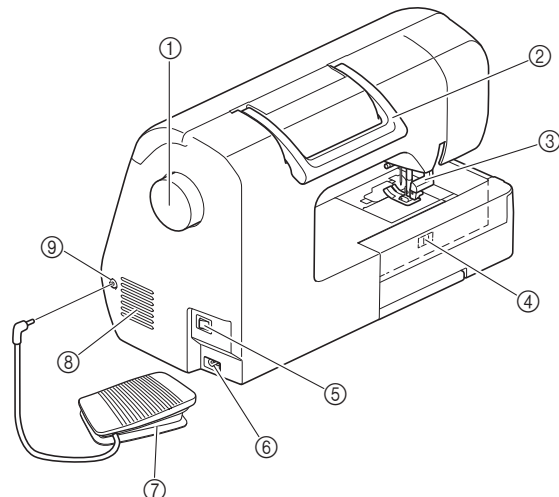

- ① **Handwheel**  
Turn the handwheel toward you (counterclockwise) to raise and lower the needle to sew one stitch.
- ② **Handle**  
Carry the machine by its handle when transporting.
- ③ **Presser foot lever**  
Raise and lower the presser foot lever to raise and lower the presser foot.
- ④ **Feed dog position switch**  
Use the feed dog position switch to lower the feed dogs.
- ⑤ **Main power switch**  
Use the main power switch to turn the machine on and off.
- ⑥ **Power supply jack**  
Insert the plug on the power supply cord into the power supply jack.
- ⑦ **Foot controller**  
Depress the foot controller to control the speed of the machine. (page B-36)
- ⑧ **Air vent**  
The air vent allows the air surrounding the motor to circulate. Do not cover the air vent while the machine is being used.
- ⑨ **Foot controller jack**  
Insert the plug on the end of the foot controller cable into the foot controller jack.



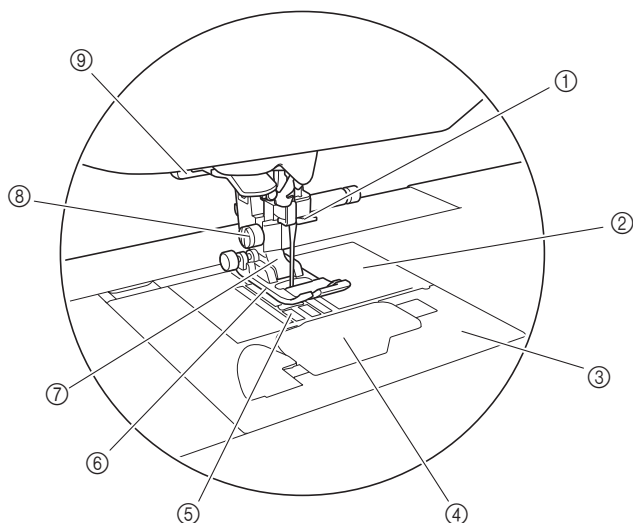



## Needle and presser foot section

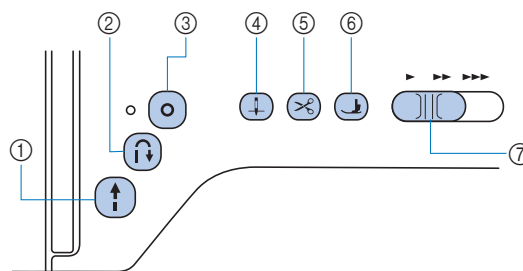

- ① **Needle bar thread guide**  
Pass the upper thread through the needle bar thread guide.
- ② **Needle plate**  
The needle plate is marked with guides for sewing straight seams.
- ③ **Needle plate cover**  
Remove the needle plate cover to clean the bobbin case and race.
- ④ **Bobbin cover/bobbin case**  
Remove the bobbin cover, and then insert the bobbin into the bobbin case.
- ⑤ **Feed dogs**  
The feed dogs feed the fabric in the sewing direction.
- ⑥ **Presser foot**  
The presser foot applies pressure consistently on the fabric as the sewing takes place. Attach the appropriate presser foot for the selected stitch.
- ⑦ **Presser foot holder**  
The presser foot is attached onto the presser foot holder.
- ⑧ **Presser foot holder screw**  
Use the presser foot holder screw to hold the presser foot in place. (page B-32)
- ⑨ **Buttonhole lever**  
Lower the buttonhole lever when sewing buttonholes and bar tacks or when darning.

## Operation buttons



- ① **“Start/Stop” button**   
Press the “Start/Stop” button to start or stop sewing. The machine stitches at a slow speed at the beginning of sewing while the button is pressed. When sewing is stopped, the needle is lowered in the fabric. For details, refer to “STARTING TO SEW” on page B-33.  
The button changes color according to the machine’s operation mode.  
Green: The machine is ready to sew or is sewing.  
Red: The machine can not sew.  
Orange: The machine is winding the bobbin thread, or the bobbin winder shaft is moved to the right side.
- ② **Reverse stitch button**   
For straight, zigzag, and elastic zigzag stitch patterns that use reverse stitches, the machine will sew reverse stitches at low speed only while holding down the Reverse stitch button. The stitches are sewn in the opposite position.  
For other stitches, use this button to sew reinforcement stitches at the beginning and end of sewing. Press and hold this button, and the machine sews 3 stitches in the same spot and stops automatically. (page B-37)
- ③ **Reinforcement stitch button**   
Use this button to sew a single stitch repeatedly and tie-off. For character/decorative stitches, press this button to end with a full stitch instead of at a mid-point. The LED light beside this button lights up while the machine is sewing a full motif, and automatically turns off when the sewing is stopped. (page B-37)
- ④ **Needle position button**   
Press the needle position button to raise or lower the needle. Pressing the button twice sews one stitch.
- ⑤ **Thread cutter button**   
Press the thread cutter button after sewing is stopped to cut both the upper and the bobbin threads. For details, refer to step 10 under “Sewing a stitch” section on page B-35.
- ⑥ **Presser foot lifter button**   
**(Equipped on some models. Refer to page B-8)**  
Press this button to lower the presser foot and apply pressure to the fabric. Press this button again to raise the presser foot.
- ⑦ **Sewing speed controller**  
Slide the sewing speed controller to adjust the sewing speed.







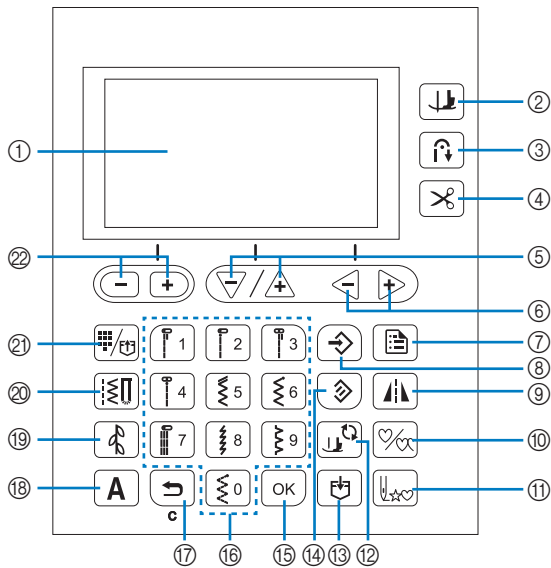









## ⚠ CAUTION

- Do not press  (Thread cutter button) after the threads have already been cut, otherwise the needle may break, the threads may become tangled or damage to the machine may occur.







## Operation panel and operation keys



The keys with \* are lit while they are ON.

- ① **LCD (liquid crystal display)**  
Settings for the selected stitch and error messages for incorrect operations appear in the LCD.  
For details, refer to "LCD" on page B-11
- ② **Pivot key** \*  
**(Equipped on some models. Refer to page B-8)**  
Press to activate pivot function.
- ③ **Automatic reverse/reinforcement key** \*  
Press to use the automatic reverse/reinforcement stitching function.
- ④ **Automatic thread cutting key** \*  
Press to select the automatic thread cutting function.
- ⑤ **Stitch length keys/Item selection keys**    
Press to adjust the stitch length or to select the next/previous items in the settings screen.
- ⑥ **Thread tension keys (Equipped on some models. Refer to page B-8)/Value selection keys**    
Press to adjust the thread tension or to change the value of the selected item in the settings screen.
- ⑦ **Settings key**   
Press to select sewing settings or other settings, or to move to next pages in the settings screen.
- ⑧ **Manual memory key**   
Press to save the adjusted stitch width and length settings. For models equipped with the thread tension keys (Refer to page B-8.), the thread tension setting is also saved.
- ⑨ **Mirror image key**   
Press to create a mirror image of the selected stitch pattern.
- ⑩ **Single/repeat sewing key**   
Press to choose single pattern or continuous patterns.
- ⑪ **Back to beginning key**   
Press this key to return to the beginning of the pattern.
- ⑫ **Presser foot/Needle exchange key**   
Press this key before changing the needle, the presser foot, etc.  
This key locks all key and button functions to prevent operation of the machine.
- ⑬ **Memory key**   
Press to save stitch pattern combinations to machine memory.
- ⑭ **Reset key**   
Press to reset the selected stitch to its original settings.
- ⑮ **OK key** 

Press to apply the selection or perform the operation.

- ⑯ **Numeric keys**  
Use these keys to quickly select one of the ten most often used stitches. When selecting other stitches, use these keys to type in the number of the desired stitch.
- ⑰ **Back key**   
Press this key to cancel the operation and return to the previous screen.  
In addition, pressing this key removes the last pattern added when combining characters or decorative stitches.
- ⑱ **Character stitch key** \*  
Press to select a character stitch.
- ⑲ **Decorative stitch key** \*  
Press to select a decorative stitch.
- ⑳ **Utility stitch key** \*  
Press to select a utility stitch.
- ㉑ **Preset utility stitch/saved pattern key** \*  
Press to select the utility stitch assigned to a numeric key or to retrieve a pattern that has been saved.
- ㉒ **Stitch width keys/Settings screen page selection keys**    
Press to adjust the stitch width or to move to previous/next pages in the settings screen.



### Note

- The operation keys of this machine are capacitive touch sensors. Operate the keys by directly touching them with your finger. The response of the keys varies according to the user. The pressure exerted on the keys does not affect the response of the keys.
- Since the operation keys react differently depending on the user, adjust the setting for the input sensitivity. (page B-14)
- When using an electrostatic touch pen, make sure that its point is 8 mm or more. Do not use a touch pen with a thin point or a unique shape.

## Using the flat bed attachment

Pull the top of the flat bed attachment to open the accessory compartments.

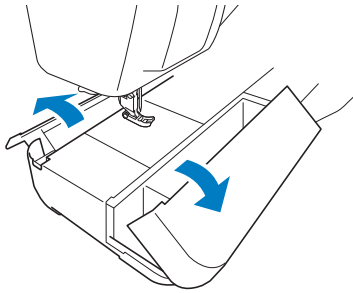



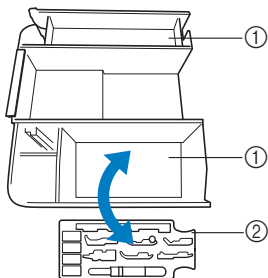







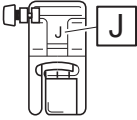
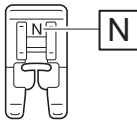
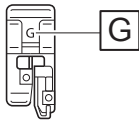
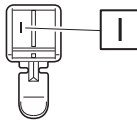
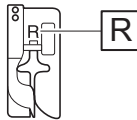
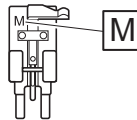
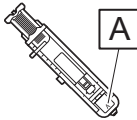



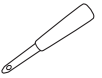
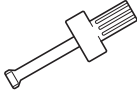

A presser foot accessory tray is stored in the accessory compartment of the flat bed attachment.

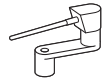

- ① Storage space of the flat bed attachment
- ② Presser foot accessory tray

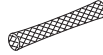
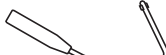
## Included accessories

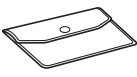
Included accessories may differ from the table below depending on your model. For more details on included accessories and their part codes of your machine, refer to the Quick Reference Guide.

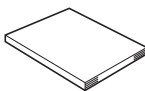
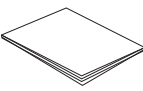
<p>1.</p>  <p>Zigzag foot "J" (on machine)</p>	<p>2.</p>  <p>Monogramming foot "N"</p>	<p>3.</p>  <p>Overcasting foot "G"</p>	<p>4.</p>  <p>Zipper foot "I"</p>	<p>5.</p>  <p>Blind stitch foot "R"</p>	<p>6.</p>  <p>Button fitting foot "M"</p>
<p>7.</p>  <p>Buttonhole foot "A"</p>	<p>8.</p>  <p>Needle set 75/11 2 needles, 90/14 2 needles, 90/14 2 needles: Ball point needle (gold colored)</p>	<p>9.</p>  <p>Twin needle 2.0/11 needle</p>	<p>10.</p>  <p>Bobbin (4) One is on machine.</p>	<p>11.</p>  <p>Seam ripper</p>	<p>12.</p>  <p>Cleaning brush</p>
<p>13.</p>  <p>Eyelet punch</p>	<p>14.</p>  <p>Screwdriver (large)</p>	<p>15.</p>  <p>L-shaped screwdriver</p>	<p>16.</p>  <p>Disc-shaped screwdriver</p>	<p>17.</p>  <p>Horizontal spool pin</p>	<p>18.</p>  <p>Spool cap (large)</p>
<p>19.</p>  <p>Spool cap (medium) (2) One is on machine.</p>	<p>20.</p>  <p>Spool cap (small)</p>	<p>21.</p>  <p>Thread spool insert (mini king thread spool)</p>	<p>22.</p>  <p>Spool net</p>	<p>23.</p>  <p>Knee lifter</p>	<p>24.</p>  <p>Foot controller</p>
<p>25.</p>  <p>Accessory bag</p>	<p>26.</p>  <p>Grid sheet set</p>	<p>27.</p>  <p>Operation Manual</p>	<p>28.</p>  <p>Quick Reference Guide</p>		

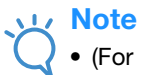

### Note

- (For U.S.A. only) Foot controller: Model T  
This foot controller can be used on the machine with product code 888-F50/F60/F70. The product code is mentioned on the machine rating plate.
- The presser foot holder screw is available through your authorized Brother dealer. (Part code: XG1343-001)
- The presser foot accessory tray is available, through your authorized Brother dealer. (Part code: XF8650-001)

## Optional accessories

The following are available as optional accessories to be purchased separately. Optional accessories differ depending on your model. For more optional accessories and their part codes, refer to the Quick Reference Guide.

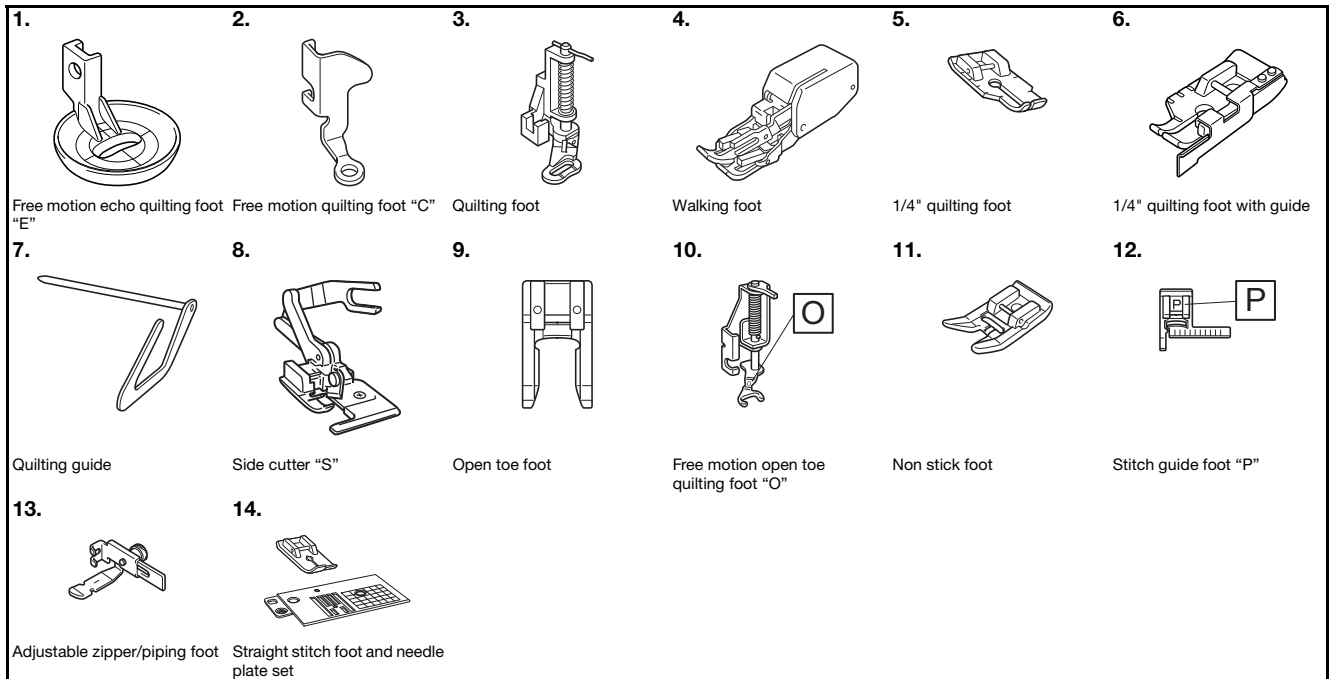

### Memo

- To obtain optional accessories or parts, contact your authorized Brother dealer.
- All specifications are correct at the time of printing. Please be aware that some specifications may change without notice.
- Visit your nearest authorized Brother dealer for a complete listing of optional accessories available for your machine.
- Always use accessories recommended for this machine.



## Functions available with each model

Specifications differ depending on the machine model. For the functions available with your sewing machine model, refer to the table below. Refer to the Quick Reference Guide for the model of your sewing machine.







	Model 3	Model 2	Model 1	Page
Automatic fabric sensor system (setting)	✓	N/A	N/A	B-43
Fine adjustment horizontal (setting)	✓	✓	N/A	D-10
Free motion foot height (setting)	✓	N/A	N/A	B-44
Free motion mode (setting)	✓	N/A	N/A	B-44
Pivoting	✓	N/A	N/A	B-43
Presser foot height (setting)	✓	N/A	N/A	B-13
Presser foot lifter button	✓	N/A	N/A	B-3
Size selection (setting)	✓*1	✓*1	✓*2	D-6
Step stitch pattern	✓	✓	N/A	D-7
Thread tension dial	N/A	N/A	✓	B-40
Thread tension key	✓	✓	N/A	B-40

\*1 Pattern size can be changed for decorative stitches, satin stitches and all fonts of character stitches.

\*2 Pattern size can be changed for character stitches other than handwriting font.

## Using the utility stitch tables in the “Sewing” section

The utility stitch numbers differ depending on the model of your machine. Refer to the Quick Reference Guide for the model of your sewing machine.

Stitch name	Stitch	Model 4			Presser foot
			Model 3, 2	Model 1	
		Stitch number			
Basting stitch		1-08	08	07	J
Straight stitch (Left)		1-01	01*	01*	
		1-02	02*	02*	
Straight stitch (Middle)		1-03	03*	03*	
Triple stretch stitch		1-05	05*	05*	

## Turning the Machine On/Off

### WARNING

- Use only regular household electricity for the power source. Using other power sources may result in fire, electric shock, or damage to the machine.
- Make sure that the plugs on the power cord are firmly inserted into the electrical outlet and the power cord receptacle on the machine. Otherwise, a fire or electric shock may result.
- Do not insert the plug on the power cord into an electrical outlet that is in poor condition.
- Turn the main power to OFF and remove the plug in the following circumstances:
  - When you are away from the machine
  - After using the machine
  - When the power fails during use
  - When the machine does not operate correctly due to a bad connection or a disconnection
  - During electrical storms

### CAUTION

- Use only the power cord included with this machine.
- Do not use extension cords or multi-plug adapters with any other appliances plugged into them. Fire or electric shock may result.
- Do not touch the plug with wet hands. Electric shock may result.
- When unplugging the machine, always turn the main power to OFF first. Always grasp the plug to remove it from the electrical outlet. Pulling on the cord may damage the cord, or lead to fire or electric shock.
- Do not allow the power cord to be cut, damaged, modified, forcefully bent, pulled, twisted, or bundled. Do not place heavy objects on the cord. Do not subject the cord to heat. These things may damage the cord, or cause fire or electric shock. If the cord or plug is damaged, take the machine to your authorized Brother dealer for repairs before continuing use.
- Unplug the power cord if the machine is not to be used for a long period of time. Otherwise, a fire may result.
- When leaving the machine unattended, either the main switch of the machine should be turned to OFF or the plug must be removed from the electrical outlet.
- When servicing the machine or when removing covers, the machine must be unplugged.
- For USA only
  - This appliance has a polarized plug (one blade wider than the other). To reduce the risk of electrical shock, this plug is intended to fit in a polarized electrical outlet only one way.
  - If the plug does not fit fully in the electrical outlet, reverse the plug. If it still does not fit, contact a qualified electrician to install the proper electrical outlet. Do not modify the plug in any way.

## Turning on the machine

- 1 Make sure that the machine is turned off (the main power switch is set to "O"), and then plug the power cord into the power supply jack on the right side of the machine.
- 2 Insert the plug of the power cord into a household electrical outlet.

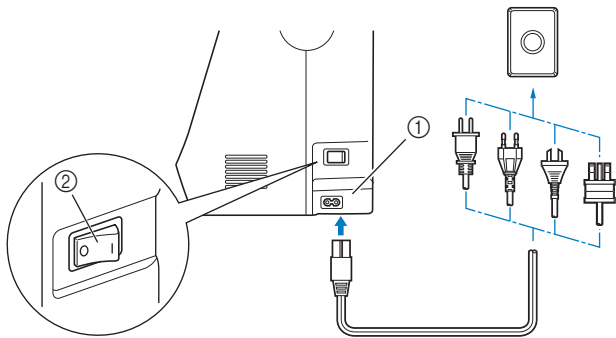

- ① Power supply jack
- ② Main power switch

- 3 Press the right side of the main power switch on the right side of the machine to turn the machine on (set it to "I").

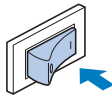

→ The light, LCD and the "Start/Stop" button light up when the machine is turned on.

### Memo

- When the machine is turned on, the needle and the feed dogs will make a sound when they move; this is not a malfunction.
- If the machine is turned off in the middle of sewing in the "Sewing" function, the operation will not resume after turning the power on again.

## Turning off the machine

When you are finished using the machine, turn it off. In addition, before transporting the machine to another location, be sure to turn it off.

- 1 Make sure that the machine is not sewing.
- 2 Press the main power switch on the right side of the machine in the direction of the "O" symbol to turn the machine off.

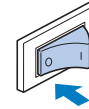

## Select machine setting for the first time

When you first turn on the machine, select the language of your choice. Follow the procedure below when the settings screen appears automatically.

- 1 Use the "-" or "+" key to choose the desired language.



- 2 Press .

## LCD

## Viewing the LCD

When the power is turned on, the LCD comes on, and the following screen is displayed. The screen will vary slightly depending on your machine model.

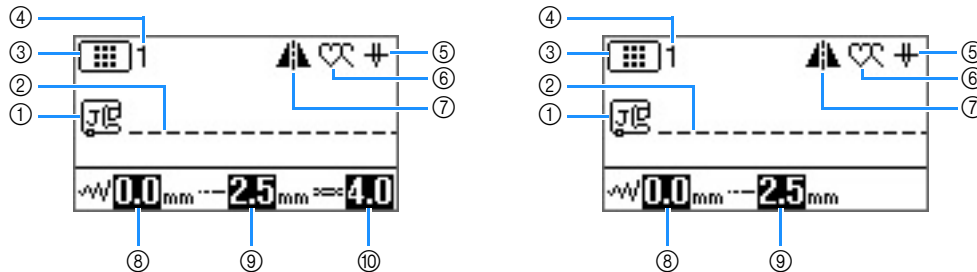

The screen is changed using the keys below the LCD.





No.	Display	Item Name	Explanation	Page
①		Presser foot	Shows presser foot to be used.	B-31
②	-	Stitch preview	Shows a preview of the selected stitch.	B-34
③		Stitch category	Shows the category of the currently selected stitch pattern. : Preset utility stitch : Utility stitch : Decorative stitch (category 1) : Decorative stitch (category 2) : Decorative stitch (category 3) : Character stitch (Gothic font) : Character stitch (Handwriting font) : Character stitch (Outline) : Character stitch (Cyrillic font) : Character stitch (Japanese font)	B-33
④	-	Stitch number	Shows the number of the currently selected stitch pattern.	B-46
⑤		Needle position setting	Shows single or twin needle mode setting, and the needle stop position. : Single needle/down position : Single needle/up position : Twin needle/down position : Twin needle/up position	B-12
⑥		Single/repeat sewing	Shows single or continuous patterns sewing mode setting. : Single sewing mode : Repeat sewing mode	D-5
⑦		Horizontal mirror image	Appears when the stitch is mirrored.	B-42
⑧		Stitch width	Shows the stitch width of the currently selected stitch pattern.	B-39
⑨		Stitch length	Shows the stitch length of the currently selected stitch pattern.	B-39
⑩		Thread tension (Equipped on some models. Refer to page B-8)	Shows the automatic thread tension setting for the currently selected stitch pattern.	B-40

## Settings screen

Press  to change various sewing machine operations and sewing settings.



Press   to move to previous/next pages.

\* You can also move to next pages by pressing .

Press  /  to select the next/previous items.

\* Press  (Downward arrow) to select the next item.

\* Press  (Upward arrow) to select the previous item.

Press   to change the value of the selected item.



### Note

- The parameters and number of pages in the settings screens differ depending on the model of your machine. For details on the settings screen for your machine, refer to the Quick Reference Guide.

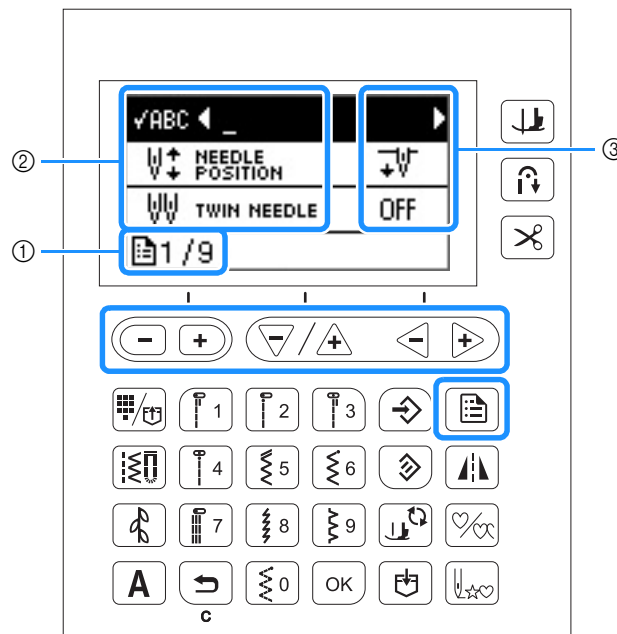

- ① Page number (The page numbers vary depending on your machine model.)
- ② Machine settings
- ③ Value

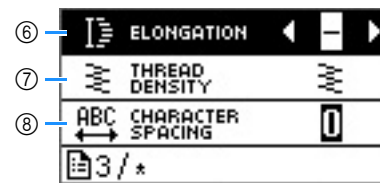
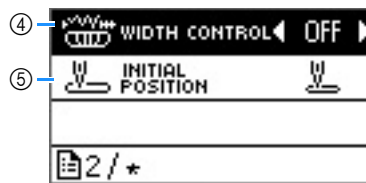
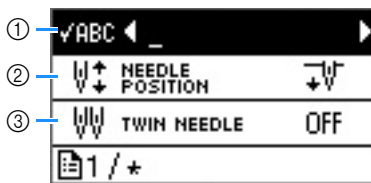

- ① Use to check the pattern when the specified pattern is not displayed on the screen. For details, refer to “Checking the selected pattern” in the “Decorative sewing” section.
- ② Select the needle stop position (the needle position for when the machine is not being operated) to be up or down.
- ③ Set to “ON” when using twin needle. For details, refer to “Using the twin needle” on page B-25.
- ④ Allows the stitch width to be adjusted using the sewing speed controller. For details, refer to “Satin stitching using the sewing speed controller” in the “Sewing” section.
- ⑤ Select either “01 Straight stitch (Left)” or “03 Straight stitch (Middle)” as the utility stitch that is automatically selected when the machine is turned on.
- ⑥ Changes the stitch length when 7 mm satin stitch patterns are selected. For details, refer to “Changing the pattern length” in the “Decorative sewing” section.
- ⑦ Changes the thread density when satin stitch patterns are selected. For details, refer to “Changing the stitch density” in the “Decorative sewing” section.
- ⑧ Changes the character spacing. For details, refer to “Changing character spacing” in the “Decorative sewing” section.



- ⑨ Changes the size of the stitch pattern. For details, refer to “Changing the pattern size” in the “Decorative sewing” section.
- ⑩ Adjusts the up and down position of the pattern. For details, refer to “Realigning the pattern” in the “Decorative sewing” section.
- ⑪ Adjusts the left and right position of the pattern. (Equipped on some models. Refer to page B-8.) For details on this function, refer to “Realigning the pattern” in the “Decorative sewing” section.
- ⑫ Adjust the presser foot pressure. The higher the number, the greater the pressure will be. For details on this function, refer to “Adjusting the presser foot pressure” on page B-43.
- ⑬ Adjust the height of the presser foot when the presser foot is raised. (Equipped on some models. Refer to page B-8.)
- ⑭ When set to “ON” the thickness of the fabric is automatically detected by an internal sensor while sewing. This enables the fabric to be fed smoothly. (Equipped on some models. Refer to page B-8.) For details on this function, refer to “Automatic Fabric Sensor System (Automatic presser foot pressure)” on page B-43.
- ⑮ Set to “ON” when sewing with the free motion mode. (Equipped on some models. Refer to page B-8.) For details on this function, refer to “Sewing with free motion mode” on page B-44.
- ⑯ Change the height of the presser foot when the machine is set to free motion sewing mode. (Equipped on some models. Refer to page B-8.) For details on this function, refer to “Sewing with free motion mode” on page B-44.
- ⑰ Change the height of the presser foot when sewing is stopped when the pivot key is selected. (Equipped on some models. Refer to page B-8.) For details on this function, refer to “Pivoting” on page B-43.





- ⑱ Specifies whether or not a beep is sounded with each operation. For details, refer to “Operation beep” in the “Appendix” section.
- ⑲ Switches the needle area and work area lights to remain “ON” or “OFF”.
- ⑳ Adjusts the brightness of the LCD.
- ㉑ When set “ON”, reinforcement stitches are sewn at the beginning and/or end of sewing for a reinforcement stitch pattern, even when the reverse button is pressed. For details, refer to “Automatic reinforcement stitching” on page B-37.
- ㉒ Select the level of the input sensitivity for operation keys. For details, refer to “Adjusting input sensitivity for operation keys” on page B-14.
- ㉓ Selects the display language. For details, refer to “Choosing the display language” on page B-14.
- ㉔ Displays the program version.

### Memo

- Press  or  to return to the original screen.

## Choosing the display language

- 1 Press .
- 2 Select  (Language) display.
- 3 Use the “-” or “+” key to choose the desired language.

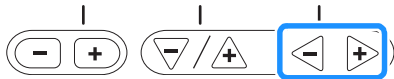
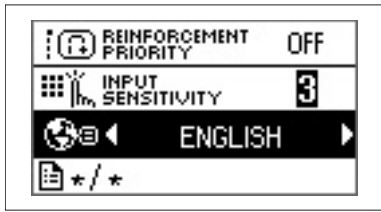

- 4 Press  to return to the original screen.

## Adjusting input sensitivity for operation keys

You can adjust the sensitivity of the operation keys to five levels. Display the settings screen to set desired level.

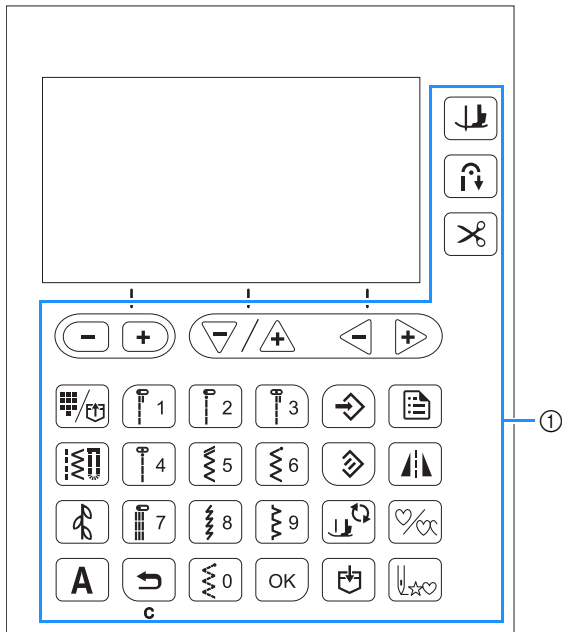

① Operation keys

- 1 Select  (Input sensitivity) in the settings screen.

- 2 Adjust the input sensitivity by pressing the “-” or “+” key.

- The lower the setting, the less sensitive the keys will be; the higher the setting, the more sensitive the keys will be. The default setting is “3”.

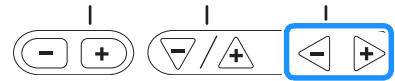
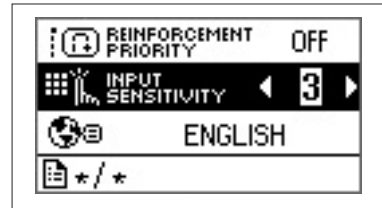

### Note

- We recommend selecting the highest setting if an electrostatic touch pen is being used.

### ■ If the machine does not respond when an operation key is pressed

Hold down  (Thread cutter button) and turn on the machine to reset the settings. Display the settings screen, and then adjust the settings again.

## Winding/Installing the Bobbin

### ⚠ CAUTION

- Only use the Bobbin (part code: SA156, SFB: XA5539-151) designed specifically for this machine. Use of any other bobbin may result in injuries or damage to the machine.
- The included bobbin was designed specifically for this machine. If bobbins from other models are used, the machine will not operate correctly. Use only the included bobbin or bobbins of the same type (part code: SA156, SFB: XA5539-151). SA156 is Class15 type bobbin.

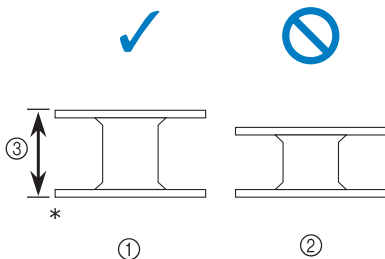

\* Actual size

- ① This model
- ② Other models
- ③ 11.5 mm (approx. 7/16 inch)

### 📖 Memo

- When the foot controller is connected, bobbin winding can be started and stopped with the foot controller.

## Winding the bobbin

This section describes how to wind thread onto a bobbin.

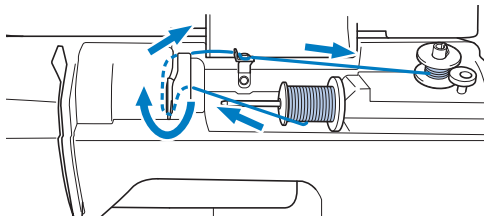

- 1 Open the top cover.

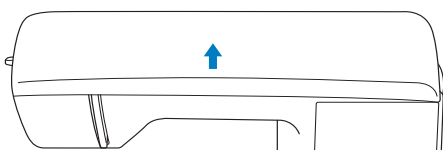

- 2 Place the bobbin on the bobbin winder shaft so that the spring on the shaft fits into the notch in the bobbin. Press down on the bobbin until it snaps into place.

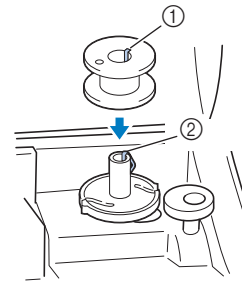

- ① Notch
- ② Bobbin winder shaft spring

- 3 Slide the bobbin winder in the direction of the arrow until it snaps into place.

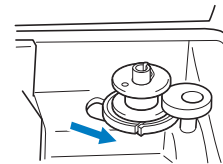

- The "Start/Stop" button lights up in orange.

- 4 Remove the spool cap that is inserted onto the spool pin.

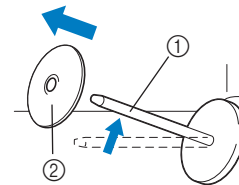

- ① Spool pin
- ② Spool cap

- 5 Place the spool of thread for the bobbin onto the spool pin.

Slide the spool onto the pin so that the spool is horizontal and the thread unwinds to the front at the bottom.

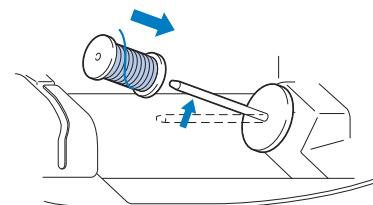

- If the spool is not positioned so that the thread unwinds correctly, the thread may become tangled around the spool pin.



**6 Slide the spool cap onto the spool pin.**

Slide the spool cap as far as possible to the right, as shown, with the rounded side on the left.

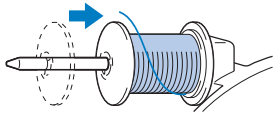

**CAUTION**

- If the spool or the spool cap is not installed correctly, the thread may become tangled around the spool pin, causing the needle to break.
- Three spool cap sizes are available, allowing you to choose a spool cap that best fits the size of spool being used. If the spool cap is too small for the spool being used, the thread may catch on the slit in the spool or the machine may be damaged.

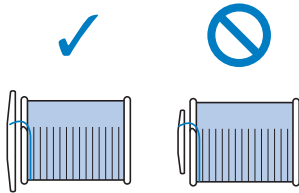

**Memo**

- When sewing with fine, cross-wound thread, use the small spool cap, and leave a small space between the cap and the spool.

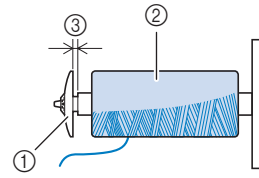

- ① Spool cap (small)
- ② Spool (cross-wound thread)
- ③ Space

- When using thread that winds off quickly, such as transparent nylon thread or metallic thread, place the spool net over the spool before placing the spool of thread onto the spool pin. If the spool net is too long, fold it to fit the size of the spool.

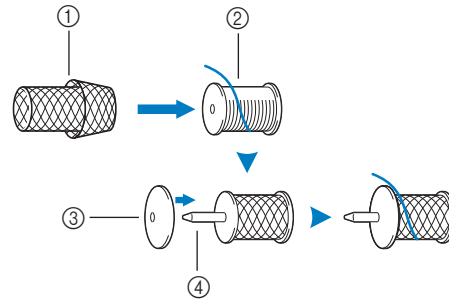

- ① Spool net
- ② Spool
- ③ Spool cap
- ④ Spool pin

- If a spool of thread whose core is 12 mm (1/2 inch) in diameter and 75 mm (3 inches) high is inserted onto the spool pin, use the thread spool insert (mini king thread spool).

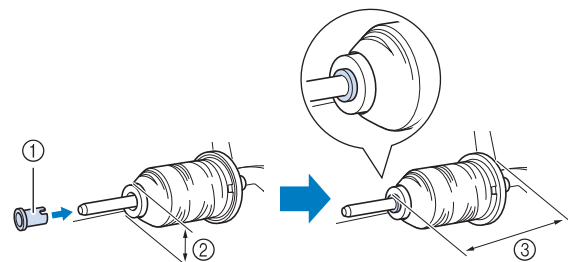

- ① Thread spool insert (mini king thread spool)
- ② 12 mm (1/2 inch)
- ③ 75 mm (3 inches)

- 7** While holding the thread near the spool with your right hand, as shown, pull the thread with your left hand, and then pass the thread behind the thread guide cover and to the front.

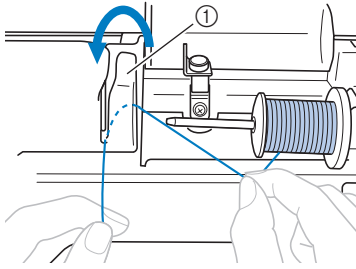

① Thread guide cover

- 8** Pass the thread under the thread guide plate, and then pull it to the right.

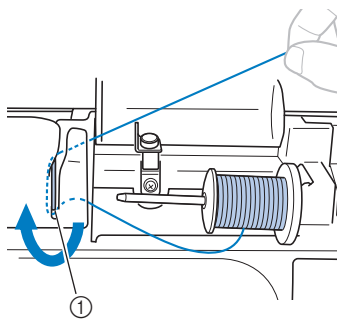

① Thread guide plate

- 9** Pass the thread under the hook on the thread guide, and then wind it counterclockwise under the pretension disk.

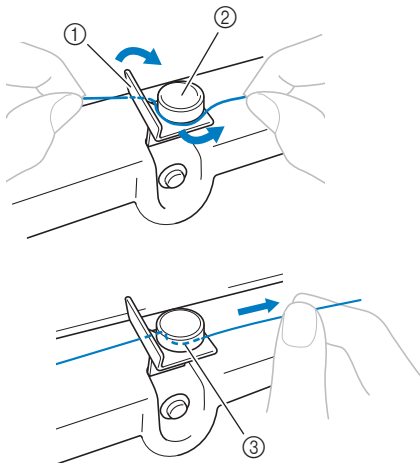

- ① Thread guide  
② Pretension disk  
③ Pull it in as far as possible



#### Note

- Make sure that the thread passes under the pretension disk.

- 10** While holding the thread with your left hand, wind the thread that was pulled out clockwise around the bobbin five or six times with your right hand.

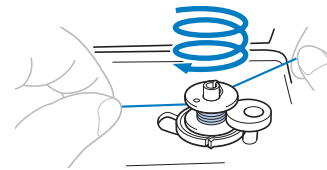

#### Note

- Make sure that the thread between the spool and the bobbin is pulled tight.
- Be sure to wind the thread clockwise around the bobbin, otherwise the thread will become wrapped around the bobbin winder shaft.

- 11** Pass the end of the thread through the guide slit in the bobbin winder seat, and then pull the thread to the right to cut it.

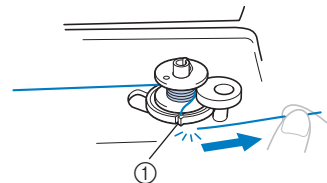

① Guide slit in bobbin winder seat (with built-in cutter)

## ⚠ CAUTION

- Be sure to cut the thread as described. If the bobbin is wound without cutting the thread using the cutter built into the slit in the bobbin winder seat, the thread may become tangled in the bobbin or the needle may bend or break when the bobbin thread starts to run out.

- 12** Slide the sewing speed controller to the right.

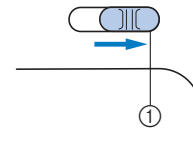

① Speed controller



#### Note

- Bobbin winding speeds may vary depending on type of thread being wound on bobbin.

- 13** Turn on the machine.

- 14** Press the “Start/Stop” button once to start winding the bobbin.  
When the foot controller is plugged in, press down on the foot controller.



① “Start/Stop” button

- 15** When the bobbin winding becomes slow, press the “Start/Stop” button once to stop the machine.  
When the foot controller is plugged in, remove your foot from the foot controller.

**⚠ CAUTION**

- When the bobbin winding becomes slow, stop the machine, otherwise the machine may be damaged.

- 16** Use scissors to cut the end of the thread wound around the bobbin.

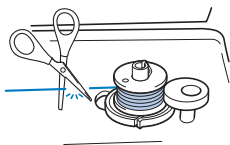

- 17** Slide the bobbin winder shaft to the left, and then remove the bobbin from the shaft.

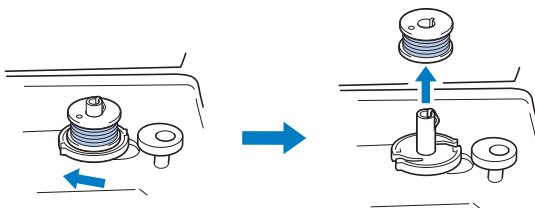

**Memo**

- If the bobbin winder shaft is set to the right side, the needle will not move. (Sewing is impossible.)

- 18** Slide the sewing speed controller back to desired sewing speed position.

- 19** Remove the spool for the bobbin thread from the spool pin.

**Memo**

- When the machine is started or the handwheel is turned after winding the bobbin, the machine will make a clicking sound; this is not a malfunction.

**Installing the bobbin**

Install the bobbin wound with thread.  
You can begin sewing immediately without pulling up the bobbin thread by simply inserting the bobbin in the bobbin case and guiding the thread through the slit in the needle plate cover.

**Memo**

- For details on sewing after pulling up the bobbin thread, for example, when making gathers or with free motion quilting, refer to “Pulling up the bobbin thread” on page B-24.

**⚠ CAUTION**

- Use a bobbin that has been correctly wound with thread, otherwise the needle may break or the thread tension will be incorrect.

- Before inserting or changing the bobbin, be sure to press (Presser foot/Needle exchange key) on the operation panel to lock all keys and buttons, otherwise injuries may occur if the “Start/Stop” button or any other button is pressed and the machine starts.

- 1** Press (Needle position button) once or twice to raise the needle, and then lower the presser foot lever.

- 2** Press .
- If is pressed while the presser foot is raised, an error message appears. Lower the presser foot.
- The screen changes, and all keys and operation buttons are locked (except .



- 3** Raise the presser foot lever.

- 4** Slide the bobbin cover latch to the right.

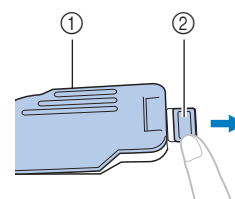

① Bobbin cover  
② Latch

5 Remove the bobbin cover.

6 Hold the bobbin with your right hand with the thread unwinding to the left, and hold the end of the thread with your left hand. Then, with your right hand, place the bobbin in the bobbin case.

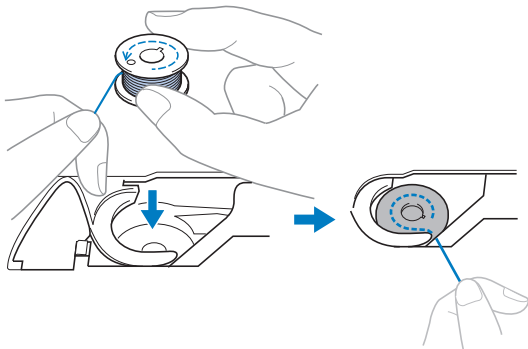

7 Lightly hold down the bobbin with your right hand (1), and then guide the end of the thread around the tab of the needle plate cover with your left hand (2).

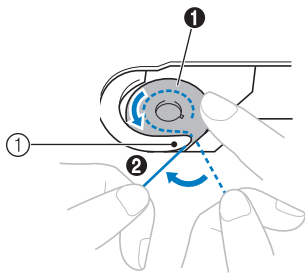

① Tab

## CAUTION

- Be sure to hold down the bobbin with your finger and unwind the bobbin thread correctly, otherwise the thread may break or the thread tension will be incorrect.

### Memo

- The order that the bobbin thread should be passed through the bobbin case is indicated by marks around the bobbin case. Be sure to thread the machine as indicated.

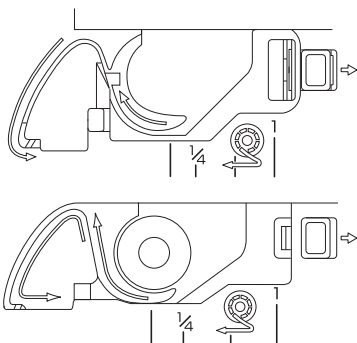

8 While lightly holding down the bobbin with your right hand (1), guide the thread through the slit in the needle plate cover (2) and lightly pull it with your left hand (3).

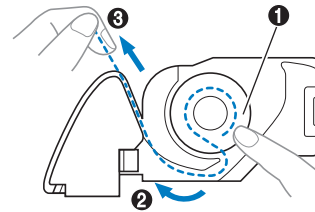

9 While lightly holding down the bobbin with your right hand (1), continue guiding the thread through the slit with your left hand (2). Then, cut the thread with the cutter (3).

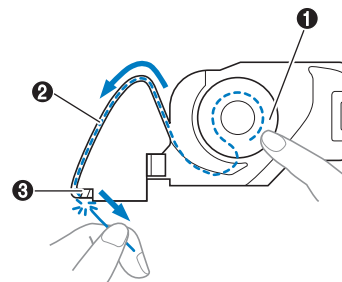

### Note

- If the thread is not correctly inserted through the tension-adjusting spring of the bobbin case, it may cause incorrect thread tension.

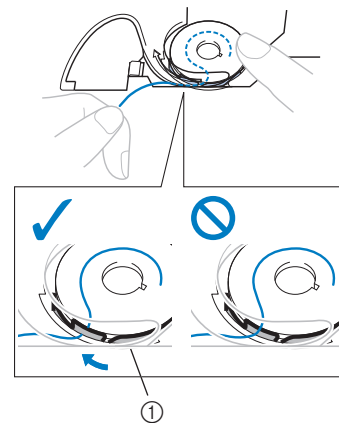

① Tension-adjusting spring

**10 Reattach the bobbin cover.**

Insert the tab in the lower-left corner of the bobbin cover, and then lightly press down on the right side.

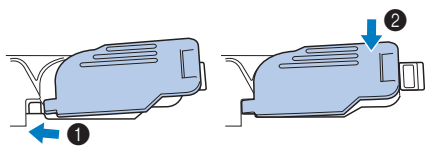

→ The bobbin threading is finished.

Next, thread the upper thread. Continue with the procedure in “Upper Threading” on page B-21.



**Memo**

- You can begin sewing without pulling up the bobbin thread. If you wish to pull up the bobbin thread before starting to sew, pull up the thread according to the procedure in “Pulling up the bobbin thread” on page B-24.

**11 Press  to unlock all keys and buttons.**

## Upper Threading

**⚠ CAUTION**

- Three spool cap sizes are available, allowing you to choose a spool cap that best fits the size of spool being used. If the spool cap is too small for the spool being used, the thread may catch on the slit in the spool or the needle may break. For more information regarding the choice of spool caps for your thread choice, see page B-16.

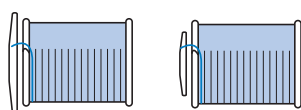

- When threading the upper thread, carefully follow the instructions. If the upper threading is not correct, the thread may become tangled or the needle may bend or break.
- Never use a thread weight of 20 or lower.
- Use the needle and the thread in the correct combination. For details on the correct combination of needles and threads, refer to "Fabric/thread/needle combinations" on page B-28.

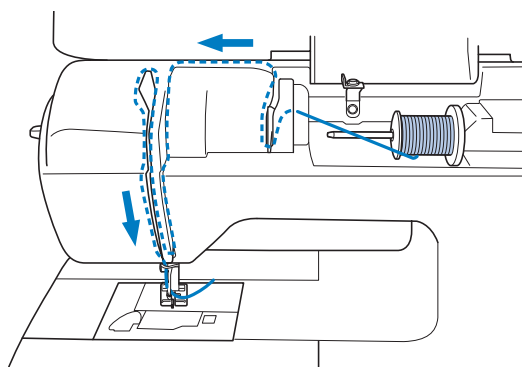
**Threading the upper thread**

- 1 Turn on the machine.
- 2 Raise the presser foot lever to raise the presser foot.

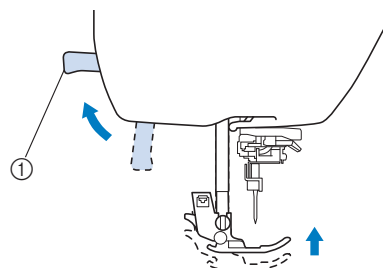



- ① Presser foot lever  
→ The upper thread shutter opens so the machine can be threaded.

**Note**

- If the presser foot is not raised, the machine cannot be threaded.

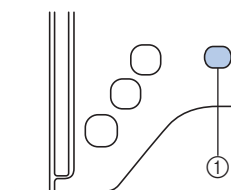
- 3 Press  (Needle position button) once or twice to raise the needle.



- ① Needle position button  
→ The needle is correctly raised when the mark on the handwheel is at the top, as shown below. Check the handwheel and, if this mark is not at this position, press  (Needle position button) until it is.

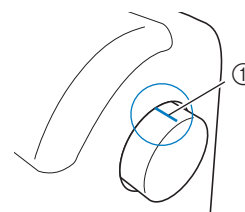

- ① Mark on handwheel

- 4 Remove the spool cap that is inserted onto the spool pin.

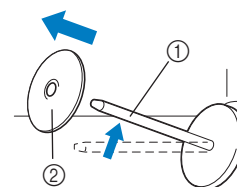

- ① Spool pin  
② Spool cap

- 5 Place the spool of thread onto the spool pin.**  
Slide the spool onto the pin so that the spool is horizontal and the thread unwinds to the front at the bottom.

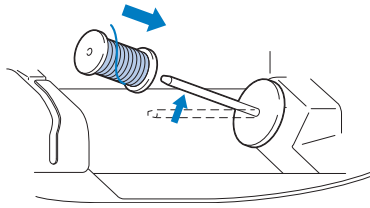

## ⚠ CAUTION

- If the spool or the spool cap is not positioned correctly, the thread may become tangled around the spool pin or the needle may break.

- 6 Slide the spool cap onto the spool pin.**  
Slide the spool cap as far as possible to the right, as shown, with the rounded side on the left.

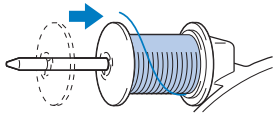

- 7 While holding the thread lightly with your right hand, pull the thread with your left hand, and then pass the thread behind the thread guide cover and to the front.**

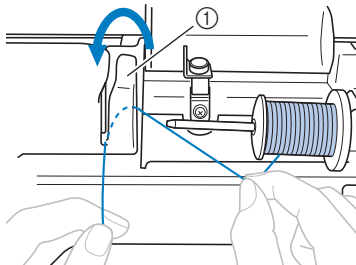

① Thread guide cover

- 8 Pass the thread under the thread guide plate, and then pull it up.**

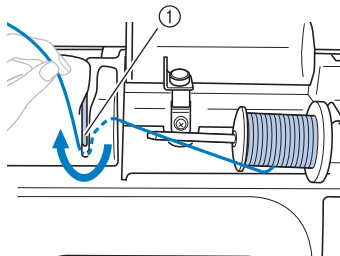

① Thread guide plate

- 9 While using your right hand to lightly hold the thread passed under the thread guide plate, pass the thread through the guides in the order shown below.**

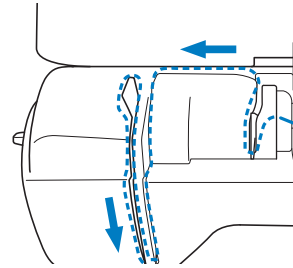

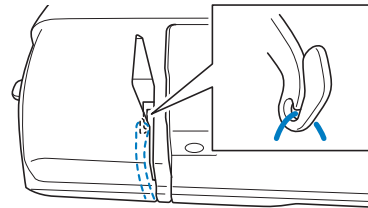

## 💡 Note

- If the presser foot has been lowered and the shutter is closed, the machine cannot be threaded. Be sure to raise the presser foot to open the shutter before threading the machine. In addition, before removing the upper thread, be sure to raise the presser foot to open the shutter.
- This machine is equipped with a window that allows you to check the position of the take-up lever. Look through this window and check that the thread is correctly fed through the take-up lever.



- 10 Lower the presser foot.**

- 11 Press .**

- If  is pressed while the presser foot is raised, an error message appears. Lower the presser foot.  
→ The screen changes, and all keys and operation buttons are locked (except .



**12 Slide the thread behind the needle bar thread guide.**

The thread can easily be slid behind the needle bar thread guide by holding the thread in your left hand, then feeding the thread with your right hand, as shown.

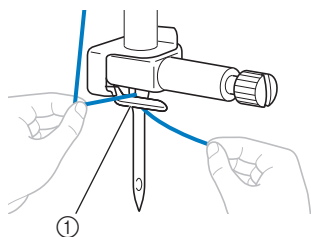

① Needle bar thread guide

**13 Raise the presser foot lever.**

## Threading the needle

### Memo

- The needle threader can be used with machine needles 75/11 through 100/16.
- The needle threader cannot be used with the wing needle or the twin needle.
- When thread such as transparent nylon monofilament or specialty threads are used it is not recommended to use the needle threader.
- If the needle threader cannot be used, refer to “Threading the needle manually (without using the needle threader)” on page B-24.

**1 Pull the end of the thread, which has been passed through the needle bar thread guide, to the left, then pass the thread through the notch of the threader thread guide ①, and then firmly pull the thread from the front and insert it into the slit of the threader thread guide disk marked “7” all the way ②.**

- Make sure that the thread passes through the notch of the threader thread guide.

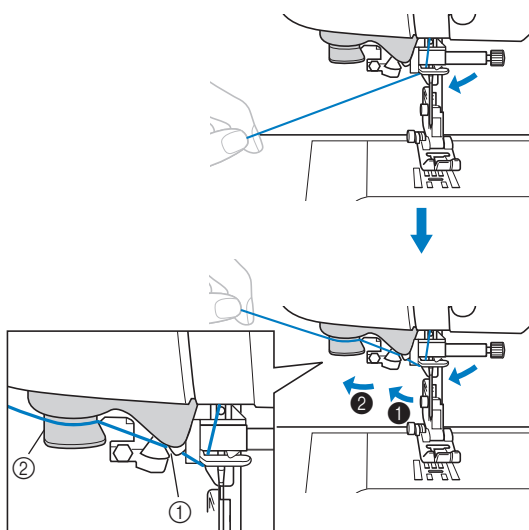

① Notch of the threader thread guide

② Threader thread guide disk

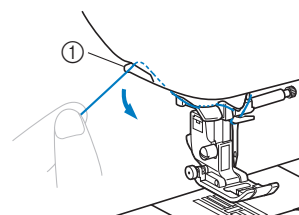
**2 Cut the thread with the cutter on the left side of the machine.**

① Cutter

### Note

- If the thread is pulled through and cannot be cut correctly, lower the presser foot lever so that the thread is held in place before cutting the thread. If this operation is performed, skip step ③.
- When using thread that quickly winds off the spool, such as metallic thread, it may be difficult to thread the needle if the thread is cut. Therefore, instead of using the thread cutter, pull out about 80 mm (approx. 3 inches) of thread after passing it through the threader thread guide disks (marked “7”).

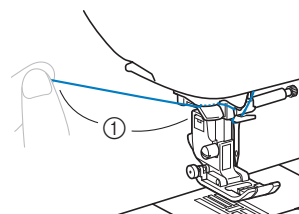

① 80 mm (approx. 3 inches) or more

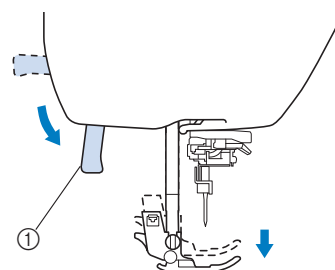
**3 Lower the presser foot lever to lower the presser foot.**

① Presser foot lever



- 4** Lower the needle threader lever on the left side of the machine until it clicks, and then slowly return the lever to its original position.

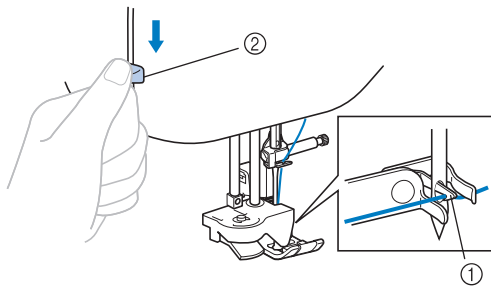

- ① Hook
- ② Needle threader lever

→ The hook is rotated and passes the thread through the eye of the needle.



**Note**

- If the needle is not raised to its highest position, the needle threader cannot thread the needle. Turn the handwheel counterclockwise until the needle is at its highest position. The needle is correctly raised when the mark on the handwheel is at the top, as shown under step 3 on page B-21.

- 5** Carefully pull the end of thread that was passed through the eye of the needle.

If the needle was not completely threaded, but a loop in the thread was formed in the eye of the needle, carefully pull the loop through the eye of the needle to pull out the end of the thread.

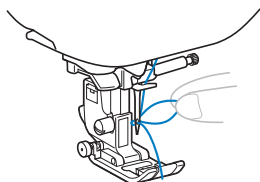

**⚠ CAUTION**

- When pulling out the thread, do not pull it with extreme force, otherwise the needle may break or bend.

- 6** Raise the presser foot lever, pass the end of the thread through and under the presser foot, and then pull out about 5 cm (approx. 2 inches) of thread toward the rear of the machine.

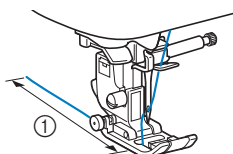

- ① 5 cm (approx. 2 inches)

- 7** Press  to unlock all keys and buttons.

**Threading the needle manually (without using the needle threader)**

When using specialty thread, such as transparent nylon thread, a wing needle or a twin needle which cannot be used with the needle threader, thread the needle as described below.

- 1** Thread the machine to the needle bar thread guide.
- For details, refer to “Upper Threading” on page B-21.
- 2** Lower the presser foot lever.

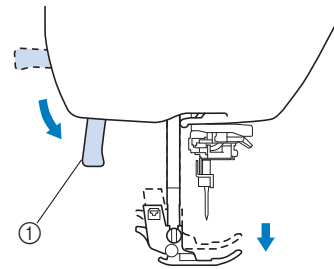

- ① Presser foot lever

- 3** Insert the thread through the eye of the needle from front to back.

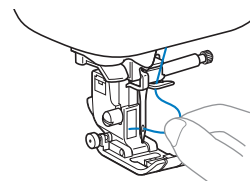

- 4** Raise the presser foot lever, pass the end of the thread through and under the presser foot, and then pull out about 5 cm (approx. 2 inches) of thread toward the rear of the machine.

- 5** Press  to unlock all keys and buttons.

**Pulling up the bobbin thread**

When making gathers or before free motion quilting, first pull up the bobbin thread as described below.

- 1** Refer to “Threading the upper thread” (page B-21) to thread the machine with the upper thread and thread the needle.
- 2** Follow steps 4 to 6 in “Installing the bobbin” (page B-18) for installing the bobbin to insert the bobbin into the bobbin case.
- 3** Pass the bobbin thread through the slot.  
Do not cut the thread with the cutter.

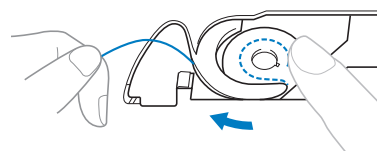

- 4** While lightly holding the upper thread with your left hand, press  (Needle position button) twice to raise the needle.

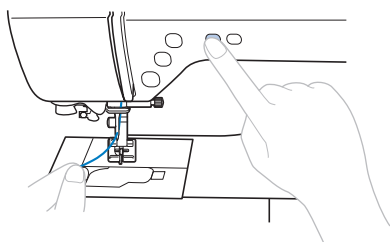

→ The bobbin thread is looped around the upper thread and can be pulled up.

- 5** Carefully pull the upper thread upward to pull out the end of the bobbin thread.

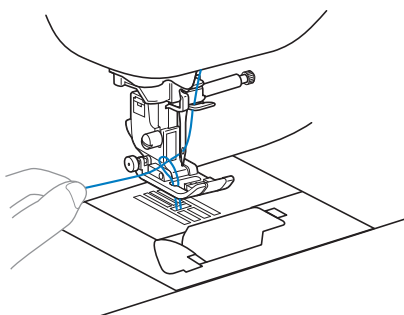

- 6** Pull up the bobbin thread, pass it under the presser foot and pull it about 10 cm (4 inches) toward the back of the machine, making it even with the upper thread.

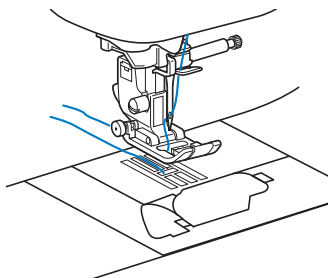

- 7** Reattach the bobbin cover.  
Insert the tab in the lower-left corner of the bobbin cover, and then lightly press down on the right side.

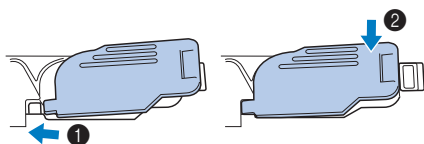

## Using the twin needle

With the twin needle, you can sew two parallel lines of the same stitch with two different threads. Both upper threads should have the same thickness and quality. Be sure to use the twin needle, the horizontal spool pin and the appropriate spool cap.

For details on the stitches that can be sewn with the twin needle, refer to "Stitch Setting Chart" beginning on page B-46.

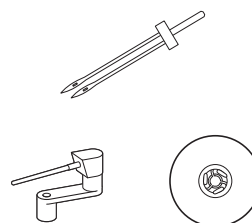

### Memo

- Traditionally a twin needle is also used for creating pin tucks. Contact your nearest authorized Brother dealer to obtain the optional pin tuck foot for your machine (SA194, F069: XF5832-001).

## CAUTION

- Only use the twin needle (2.0/11 needle, part code: X59296-121). Use of any other needle may bend the needle or damage the machine.
- Never use bent needles. Bent needles can easily break, possibly resulting in injuries.
- The needle threader cannot be used with the twin needle. If the needle threader is used with the twin needle, the machine may be damaged.

- 1** Install the twin needle.
  - For details on installing a needle, refer to "Replacing the needle" on page B-29.
- 2** Thread the upper thread for the left needle eye.
  - For details, refer to steps **1** through **12** of "Threading the upper thread" on page B-21.
- 3** Manually thread the left needle with the upper thread.
  - Pass the thread through the eye of the needle from the front.

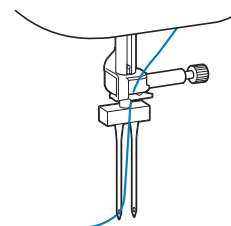

**4** Insert the horizontal spool pin onto the bobbin winder shaft.

Insert the horizontal spool pin so that it is perpendicular to the bobbin winder shaft.

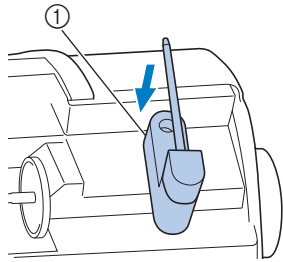

① Bobbin winder shaft

**5** Swing the spool pin toward the left so that it is horizontal.

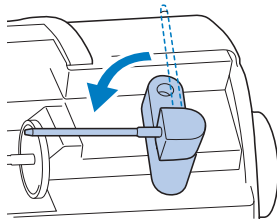

**6** Place the upper thread spool for the needle on the right side onto the horizontal spool pin, and then secure it with the spool cap.

The thread should unroll from the top front of the spool.

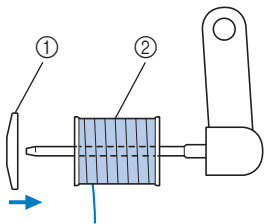

① Spool cap  
② Spool

**7** Thread the upper thread in the same way that the upper thread for the left side was threaded.

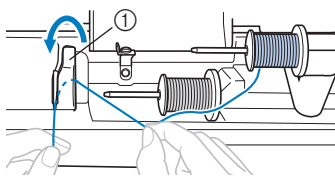

① Thread guide cover

- For details, refer to steps **7** through **9** of “Threading the upper thread” on page B-21.

**8** Without passing the thread through the needle bar thread guide, manually thread the right needle.

Insert the thread through the eye of the needle from the front.

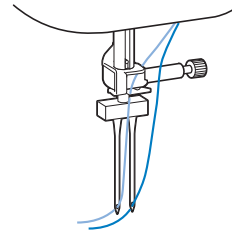

- The needle threader cannot be used with the twin needle. If the needle threader is used with the twin needle, the machine may be damaged.

**9** Attach zigzag foot “J”.

- For details on changing the presser foot, refer to “Replacing the presser foot” on page B-31.

**⚠ CAUTION**

- When using the twin needle, be sure to attach zigzag foot “J”. If bunched stitches occur, use presser foot “N” or attach stabilizer material.

**10** Turn on the machine and select a stitch.

- For stitch selection see “Selecting a stitch pattern” on page B-34.
- See “Stitch Setting Chart” on page B-46 for stitches that use a twin needle.

**⚠ CAUTION**

- When using the twin needle, be sure to select an appropriate stitch, otherwise the needle may break or the machine may be damaged.

**11** Select  (Twin needle) in the settings screen.

**12** Set the twin needle mode to “ON.”

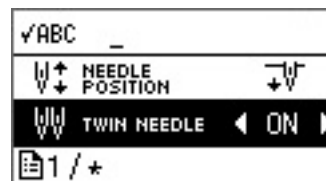

**13** Press .

**⚠ CAUTION**

- When using the twin needle, be sure to select the twin needle setting, otherwise the needle may break or the machine may be damaged.

**14 Start sewing.**

- For details on starting to sew, refer to “STARTING TO SEW” on page B-33.

→ Two lines of stitching are sewn parallel to each other.

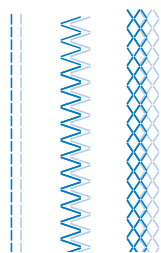
**Note**

- When changing the sewing direction, press  (Needle position button) to raise the needle from the fabric, and then raise the presser foot lever and turn the fabric.

**⚠ CAUTION**

- Do not try turning the fabric while the twin needle is down in the fabric, otherwise the needle may break or the machine may be damaged.

## Replacing the Needle

Be sure to observe the following precautions concerning the handling of the needle. Failure to observe these precautions is extremely dangerous, for example, if the needle breaks and fragments are dispersed. Be sure to read and carefully follow the instructions below.

### CAUTION

- Only use recommended home machine needles. Use of any other needle may bend the needle or damage the machine.
- Never use bent needles. Bent needles can easily break, possibly resulting in injuries.

### Fabric/thread/needle combinations

The machine needle that should be used depends on the fabric and thread thickness. Refer to the following table when choosing the thread and needle appropriate for the fabric that you wish to sew.

Fabric Type/Application		Thread		Size of Needle
		Type	Size	
Medium weight fabrics	Broadcloth	Cotton thread	60–90	75/11–90/14
	Taffeta	Synthetic thread		
	Flannel, Gabardine	Silk thread	50	
Thin fabrics	Lawn	Cotton thread	60–90	65/9–75/11
	Georgette	Synthetic thread		
	Challis, Satin	Silk thread	50	
Heavy fabrics	Denim	Cotton thread	30	100/16
			50	90/14–100/16
	Corduroy	Synthetic thread	50–60	
Tweed	Silk thread			
Stretch fabrics	Jersey	Thread for knits	50–60	Ball point needle 75/11–90/14 (gold colored)
	Tricot			
Easily frayed fabrics		Cotton thread	50–90	65/9–90/14
		Synthetic thread		
		Silk thread	50	
For top-stitching		Synthetic thread	30	100/16
		Silk thread	50–90	90/11–90/14



#### Note

- Never use thread of 20 weight or lower. It may cause machine to malfunction.

#### ■ Thread and needle number

The lower the thread number is, the heavier the thread; the higher the needle number, the larger the needle.

#### ■ Ball point needle (gold colored)

To avoid skipped stitches use ball point needles (75/11–90/14) with stretch fabrics.

#### ■ Transparent nylon thread

Use a 90/14 to 100/16 needle, regardless of the fabric or thread.

### CAUTION

- The appropriate fabric, thread and needle combinations are shown in the table above. If the combination of the fabric, thread and needle is not correct, particularly when sewing heavy fabrics (such as denim) with thin needles (such as 65/9 to 75/11), the needle may bend or break. In addition, the stitching may be uneven or puckered or there may be skipped stitches.

## Checking the needle

Sewing with a bent needle is extremely dangerous since the needle may break while the machine is being operated.

Before using the needle, place the flat side of the needle on a flat surface and check that the distance between the needle and the flat surface is even.

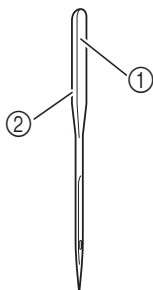

- ① Flat side
- ② Needle type marking

### ⚠ CAUTION

- If the distance between the needle and the flat surface is not even, the needle is bent. Do not use a bent needle.

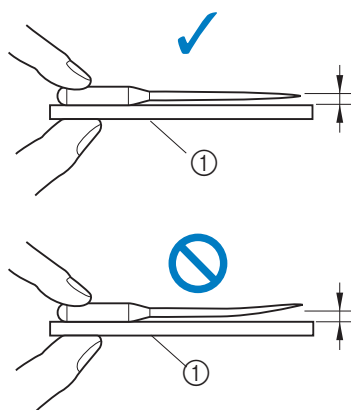

- ① Flat surface

## Replacing the needle

Use the screwdriver and a needle that has been determined to be straight according to the instructions in "Checking the needle".

- 1 Press (Needle position button) once or twice to raise the needle.
- 2 Place fabric or paper under the presser foot to cover the hole in the needle plate.

### Note

- Before replacing the needle, cover the hole in the needle plate with fabric or paper to prevent the needle from falling into the machine.

- 3 Lower the presser foot.

- 4 Press .

- If is pressed while the presser foot is raised, an error message appears. Lower the presser foot.  
→ The screen changes, and all keys and operation buttons are locked (except .



- 5 Hold the needle with your left hand, and then use a screwdriver to turn the needle clamp screw toward you (counterclockwise) to remove the needle.

- The needle clamp screw can also be loosened or tightened with the L-shaped (or disc-shaped) screwdriver.

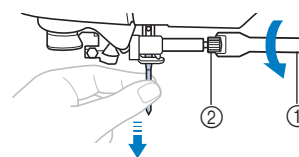

- ① Screwdriver
- ② Needle clamp screw

- Do not apply a strong force when loosening or tightening the needle clamp screw, otherwise certain parts of the machine may be damaged.

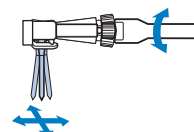

- 6 With the flat side of the needle toward the rear of the machine, insert the needle until it touches the needle stopper.

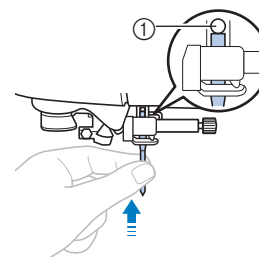

- ① Needle stopper

- 7 While holding the needle with your left hand, use the screwdriver to tighten the needle clamp screw.

Turn the screw toward the back of the machine (clockwise).

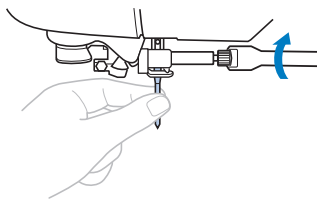

## **⚠ CAUTION**

- Be sure to insert the needle until it touches the needle stopper and securely tighten the needle clamp screw with the screwdriver, otherwise the needle may break or damage may result.





- 8 Press  to unlock all keys and buttons.

# Replacing the Presser Foot

## ⚠ CAUTION

- Use the presser foot appropriate for the type of stitch that you wish to sew, otherwise the needle may hit the presser foot, causing the needle to bend or break.
- Only use presser feet designed specifically for this machine. Use of any other presser foot may result in injuries or damage to the machine.

### Replacing the presser foot

- 1 Press  (Needle position button) once or twice to raise the needle.
- 2 Lower the presser foot.
- 3 Press .
  - If  is pressed while the presser foot is raised, an error message appears. Lower the presser foot.
  - The screen changes, and all keys and operation buttons are locked (except .



- 4 Raise the presser foot lever.
- 5 Press the black button at the back of the presser foot holder.

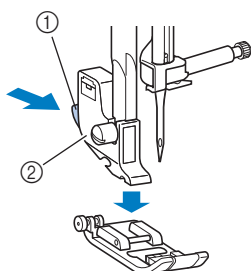

- ① Black button
- ② Presser foot holder

- 6 Place a different presser foot below the holder so that the presser foot pin is aligned with the notch in the holder.

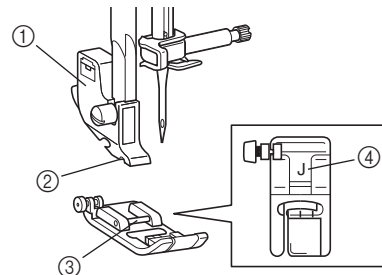

- ① Presser foot holder
- ② Notch
- ③ Pin
- ④ Presser foot type

- 7 Slowly lower the presser foot lever so that the presser foot pin snaps into the notch in the presser foot holder.

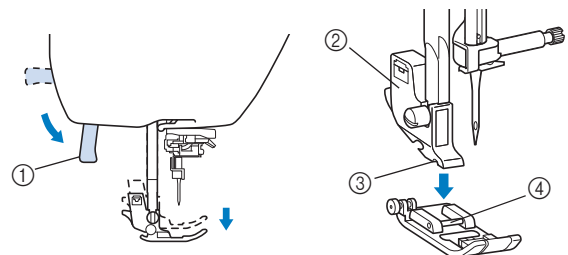

- ① Presser foot lever
- ② Presser foot holder
- ③ Notch
- ④ Pin
- The presser foot is attached.

- 8 Raise the presser foot lever to check that the presser foot is securely attached.

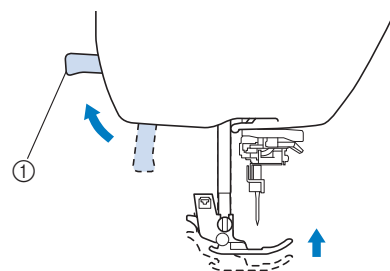

- ① Presser foot lever

- 9 Press  to unlock all keys and buttons.



**Note**

- When a stitch is selected, the icon for the presser foot that should be used appears in the screen. Check that the correct presser foot is attached before starting to sew. If the wrong presser foot is installed, turn off the machine, attach the correct presser foot, turn machine back on and then select the desired stitch again.

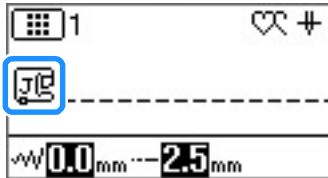

	Zigzag foot "J"
	Monogramming foot "N"
	Overcasting foot "G"
	Buttonhole foot "A"
	Blind stitch foot "R"
	Button fitting foot "M"
	Side cutter "S"

- For details on the presser foot that should be used with the selected stitch, refer to "Stitch Setting Chart" on page B-46.

### Removing and attaching the presser foot holder

Remove the presser foot holder when cleaning the machine or when installing a presser foot that does not use the presser foot holder, such as the walking foot and quilting foot. Use the screwdriver to remove the presser foot holder.

**1 Remove the presser foot.**

- For details, refer to "Replacing the presser foot" on page B-31.

**2 Use the screwdriver to loosen the presser foot holder screw.**

Turn the screw toward the back of the machine (counterclockwise).

- The presser foot holder screw can also be loosened or tightened with the L-shaped (or disc-shaped) screwdriver.

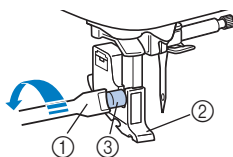

- ① Screwdriver
- ② Presser foot holder
- ③ Presser foot holder screw

### Attaching the presser foot holder

**1 Raise the presser foot lever.**

**2 Align the presser foot holder with the lower-left side of the presser bar.**

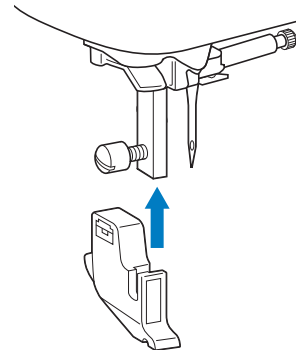

**3 Hold the presser foot holder in place with your right hand, and then tighten the screw using the screwdriver in your left hand.**

Turn the screw toward you (clockwise).

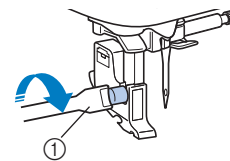

- ① Screwdriver

## CAUTION

- Be sure to securely tighten the presser foot holder screw, otherwise the presser foot holder may fall off and the needle may strike it, causing the needle to bend or break.

**Note**

- If the presser foot holder is not correctly installed, the thread tension will be incorrect.

# Chapter 2 STARTING TO SEW

B

STARTING TO SEW

## Sewing

## ⚠ CAUTION

- While the machine is in operation, pay special attention to the needle location. In addition, keep your hands away from all moving parts such as the needle and handwheel, otherwise injuries may occur.
- Do not pull or push the fabric too hard while sewing, otherwise injuries may occur or the needle may break.
- Never use bent needles. Bent needles can easily break, possibly resulting in injuries.
- Make sure that the needle does not strike basting pins, otherwise the needle may break or bend.

## Stitch selection methods

A stitch can be selected from the following methods available.

Stitch patterns can be selected through either direct select (by pressing the designated key for a specific stitch) or number selection (by entering the number for the stitch pattern).

For details on the types of stitches available, refer to the Quick Reference Guide.



### ■ Direct selection

With direct selection, there are two stitch modes listed below. Each press of  switches the modes.

#### □ Preset utility stitch



-  The most frequently used utility stitches have been assigned to the numeric keys. These stitches can be selected simply by pressing the designated key. For details, refer to “Preset utility stitches” on page B-52.

#### □ Saved patterns

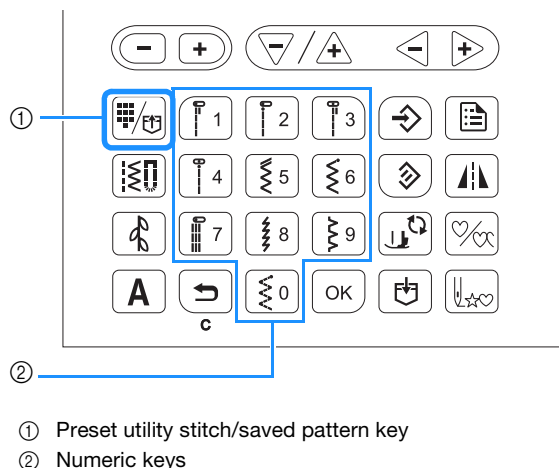
-  Frequently used patterns and combined patterns can be saved on the machine’s memory and easily retrieved using  (Preset utility stitch/saved pattern key) and the numeric keys. For details, refer to “Saving a pattern” in the “Decorative sewing” section.



### ■ Number selection

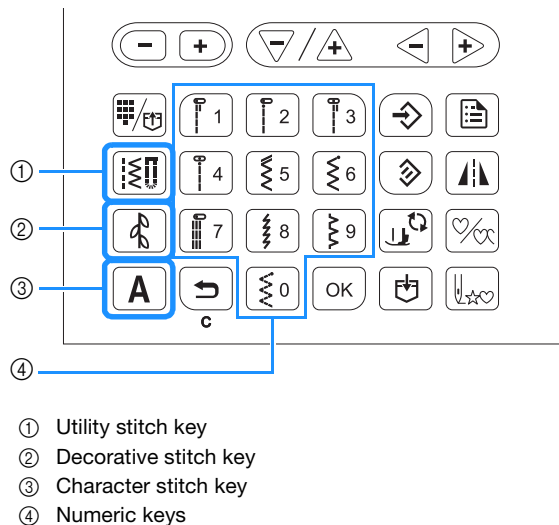

After pressing  (Utility stitch key),  (Decorative stitch key) or **A** (Character stitch key) to select the stitch mode, use the numeric keys to type in the number for the desired stitch.



#### □ Utility stitches

 There are various utility stitches, including straight stitches, overcasting stitches and buttonhole stitches.

#### □ Decorative stitches

There are three decorative stitch modes: decorative stitch 1 mode , decorative stitch 2 mode  and decorative stitch 3 mode .

For details, refer to “Selecting stitch patterns” in the “Decorative sewing” section.

□ **A** Character stitches

There are five character stitch modes: Gothic font mode **AB**, Handwriting font mode , Outline font mode **AE**, Cyrillic font mode **AE** and Japanese font mode あい.

For details, refer to “Selecting stitch patterns” in the “Decorative sewing” section.

## Selecting a stitch pattern

### ■ When selecting a utility stitch

1 Press .

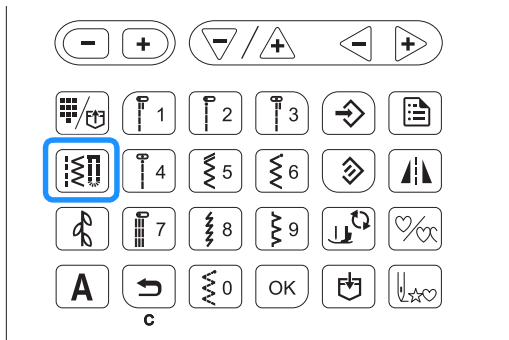

→  is displayed on the upper-left corner of the LCD screen.

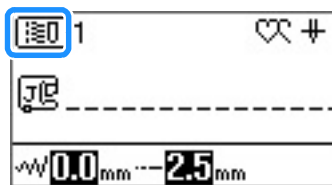

2 Enter the number of the desired stitch using numeric keys.

- For number of each stitch, refer to “Stitch Setting Chart” on page B-46 or the Quick Reference Guide.
  - For stitches 01 through 09, the stitch can also be selected by using the numeric keys to type in a one-digit number, then pressing **OK**.
  - When using one-digit numbers and it is entered incorrectly, press  to erase the entered number.
- The selected stitch is displayed on the LCD screen.

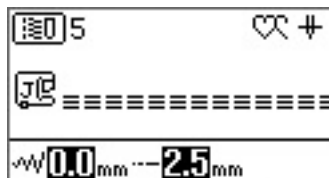

### ■ When selecting from the preset utility stitches

Since various stitches have been assigned to the numeric keys, these stitches can be selected simply by pressing the designated numeric key.

1 Check that  appears in the upper-left corner of the screen.

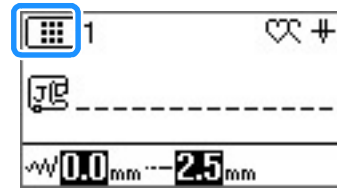

If a different icon is displayed, press .

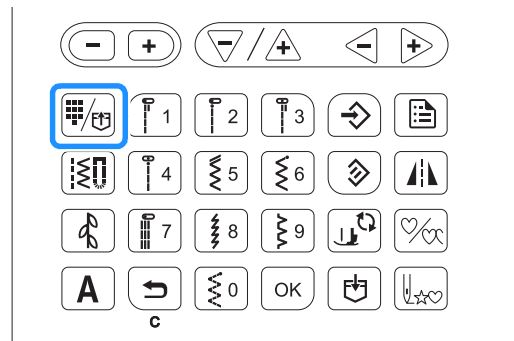

2 Press the numeric key on which the desired stitch is printed.

### ■ When selecting a character/decorative stitch

After pressing  or **A** on the operation panel the necessary number of times, enter a number.

For more details, refer to “Selecting stitch patterns” in the “Decorative sewing” section.

## Sewing a stitch

- 1 Turn the main power to ON and push  (Needle position button) to raise the needle.
- 2 Select the desired stitch following the procedure described in "Selecting a stitch pattern" above.
- 3 If necessary, specify the setting for automatic reverse/reinforcement stitching and adjust the stitch length, etc.
  - For details on adjusting the stitch width and length, refer to "Setting the stitch width" on page B-39 and "Setting the stitch length" on page B-39.



### Note

- When a stitch is selected, the icon for the presser foot that should be used appears on the screen. Check that the correct presser foot is attached before starting to sew. If the wrong presser foot is installed, turn off the machine, attach the correct presser foot, turn machine back on and then select the desired stitch again.

- 4 Install the presser foot.
  - For details on changing the presser foot, refer to "Replacing the Presser Foot" on page B-31.

## CAUTION

- Always use the correct presser foot. If the wrong presser foot is used, the needle may strike the presser foot and bend or break, possibly resulting in injury. Refer to page B-46 for presser foot recommendations.

- 5 Set the fabric under the presser foot. Hold the fabric and thread with your left hand, and rotate the handwheel counterclockwise or press  (needle position button) to set the needle in the sewing start position.

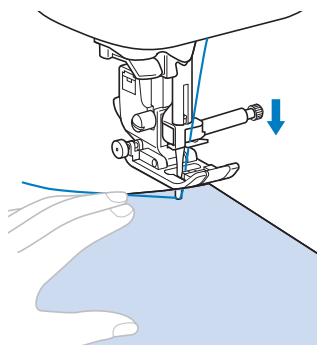

### Memo

- The black button on the left side of presser foot "J" should be pressed only if the fabric does not feed or when sewing thick seams. For details, refer to "Sewing thick fabrics" in the "Sewing" section. Normally, you can sew without pressing the black button.

- 6 Lower the presser foot.
  - You do not have to pull up the bobbin thread.

- 7 Adjust the sewing speed with the sewing speed controller.
  - You can use this controller to adjust sewing speed during sewing.

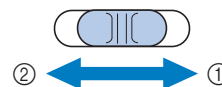

- ① Fast
- ② Slow

- 8 Press the "Start/Stop" button to start sewing.
  - Guide the fabric lightly by hand.

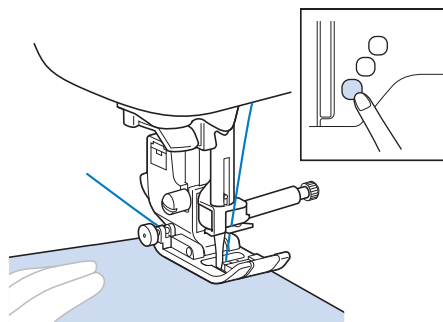

### Memo

- When the foot controller is being used, you cannot start sewing by pressing the "Start/Stop" button.

- 9 Press the "Start/Stop" button again to stop sewing.

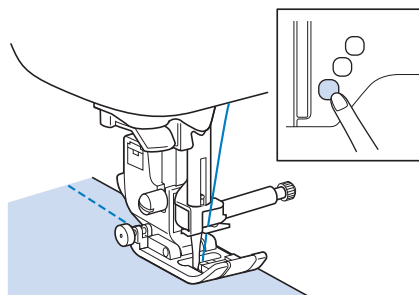

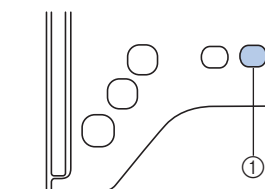

- 10 Press the  (Thread cutter button) to trim the upper and lower threads.



- ① Thread cutter button
- The needle will return to the up position automatically.

## ⚠ CAUTION

- Do not press  (Thread cutter button) after the threads have been cut. Doing so could tangle the thread or break the needle and damage the machine.
- Do not press  (Thread cutter button) when there is no fabric set in the machine or during machine operation. The thread may tangle, possibly resulting in damage.



### Note

- When cutting thread such as nylon monofilament thread, or other decorative threads, use the thread cutter on the side of the machine.

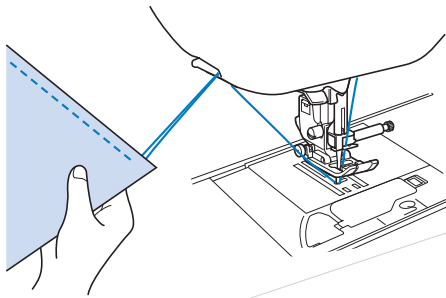

- 11 When the needle has stopped moving, raise the presser foot and remove the fabric.

### ■ Using the foot controller

You can also use the foot controller to start and stop sewing.

## ⚠ CAUTION

- Do not allow fabric pieces and dust to collect in the foot controller. Doing so could cause a fire or an electric shock.



### Memo

- When the foot controller is being used, you cannot start sewing by pressing the “Start/Stop” button.
- Bobbin winding can be started and stopped with the foot controller.

- 1 Turn off the machine.

- 2 Insert the foot controller plug into its jack on the machine.

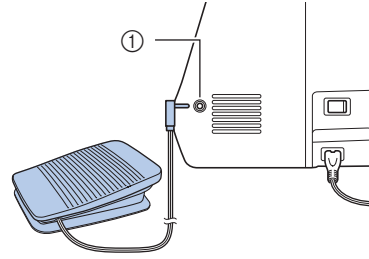

① Foot controller jack

- 3 Turn on the machine.

- 4 Slowly depress the foot controller to start sewing.

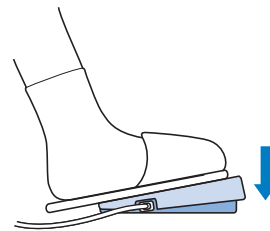



### Memo

- The speed that is set using the sewing speed controller will be the foot controller's maximum sewing speed.

- 5 Release the foot controller to stop the machine.



## Sewing reinforcement stitches

Reverse/reinforcement stitches are generally necessary at the beginning and end of sewing. You can use  (Reverse stitch button) to sew reverse/reinforcement stitches (Refer to “Stitch Setting Chart” under the column for “Reverse/ Reinforcement stitching” on page B-46.).

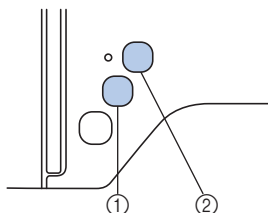
While pressing , the machine will sew 3 to 5 reinforcement stitches at that point and then stop.



- ① Reverse stitch button
- ② Reinforcement stitch button

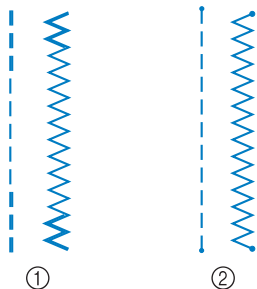

If the automatic reinforcement stitch is selected on the screen, reverse stitches (or reinforcement stitches) will be sewn automatically at the beginning of sewing when the “Start/ Stop” button is pressed. Press  (Reverse stitch button) or  (Reinforcement stitch button) to sew reverse stitches or reinforcement stitches automatically at the end of sewing.



- ① Reverse stitch
- ② Reinforcement stitch

The operation performed when the button is pressed differs depending on the selected pattern. Refer to the table in “Automatic reinforcement stitching” on page B-37.

### Memo

- While pressing  (Reinforcement stitch button) when sewing character/decorative stitch pattern, you can end sewing with a completed motif instead of at the midpoint of a stitch motif.
- The green light on the left of  (Reinforcement stitch button) lights up while the machine is sewing a full motif, and it automatically turns off when the sewing is stopped.

## Automatic reinforcement stitching

After selecting a stitch motif, turn on the automatic reinforcement stitching function before sewing, and the machine will automatically sew reinforcement stitches (or reverse stitches, depending on the stitch motif) at the beginning and end of sewing. Refer to the table on page B-38.

- 1 Select a stitch pattern.
- 2 Press  to set the automatic reinforcement stitching function.

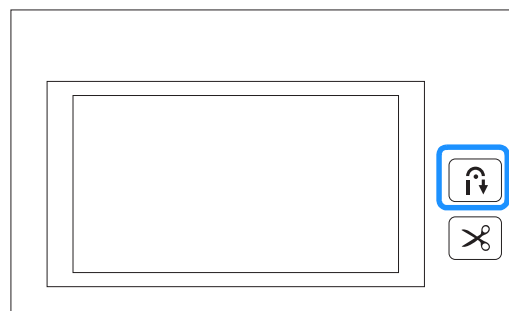

→ The key will be lit.

### Memo

- Some stitches, such as buttonholes and bar tacks, require reinforcement stitches at the beginning of sewing. If you select one of these stitches, the machine will automatically turn on this function (the key is lit when the stitch is selected).

- 3 Set the fabric in the start position and begin sewing.

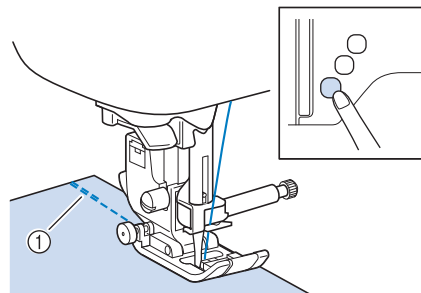

- ① Reverse stitches (or reinforcement stitches)
- The machine will automatically sew reverse stitches (or reinforcement stitches) and then continue sewing.

### Memo

- When selecting the stitches below, the machine will automatically sew reverse stitches at the beginning of the stitch.



- If you press the “Start/Stop” button to pause sewing, press it again to continue. The machine will not sew reverse/reinforcement stitches again.

4 Press  (Reverse stitch button) or  (Reinforcement stitch button).

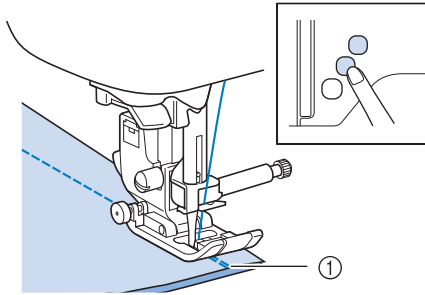









① Reverse stitches (or reinforcement stitches)  
 → The machine will sew reverse stitches (or reinforcement stitches) and stop.

 **Memo**

- To turn off the automatic reinforcement stitching function, press  so that the key is no longer lit.

The operation performed when the button is pressed differs depending on the selected pattern. Refer to the following table for details on the operation that is performed when the button is pressed.

	Reverse stitch button 	Reinforcement stitch button 
When the automatic reinforcement stitching function is not active while selecting utility stitches like examples shown below 	Machine starts sewing the stitches and only sews reverse stitches while holding the Reverse stitch button.	Machine starts sewing the stitches and sews 3 - 5 reinforcement stitches while holding the Reinforcement stitch button.
When the automatic reinforcement stitching function is not active while selecting utility stitches like examples shown below 	Machine starts sewing the stitches and only sews reverse stitches while holding the Reverse stitch button.*	Machine starts sewing the stitches and sews 3 - 5 reinforcement stitches while holding the Reinforcement stitch button.
When the automatic reinforcement stitching function is active while selecting utility stitches like examples shown below 	Machine sews reverse stitches at the beginning and end of sewing.	Machine sews reverse stitches at the beginning and reinforcement stitches at the end of sewing.
When the automatic reinforcement stitching function is active while selecting utility stitches like examples shown below 	Machine sews reinforcement stitches at the beginning and reverse stitches at the end of sewing.*	Machine sews reinforcement stitches at the beginning and end of sewing.

	Reverse stitch button 	Reinforcement stitch button 
When the automatic reinforcement stitching function is not active while selecting character/decorative stitches	Machine starts sewing and then sews reinforcement stitches while holding the Reverse stitch button.	Machine starts sewing at the beginning, then completes the pattern and sews reinforcement stitches at the end of sewing.
When the automatic reinforcement stitching function is active while selecting character/decorative stitches	Machine sews reinforcement stitches at the beginning and sews reinforcement stitches when the Reverse stitch button is pressed.	Machine sews reinforcement stitches at the beginning, then completes the pattern and sews reinforcement stitches at the end of sewing.

\* If  (Reinforcement priority) in the settings screen is set to "ON", reinforcement stitches are sewn instead of reverse stitches.

## Setting the Stitch

This machine is preset with the default settings for the stitch width and stitch length for each stitch. Some models are also preset with the default settings for upper thread tension for each stitch.

However, you can change their settings or adjust them by following the procedure described in this section.

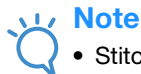

### Note

- Stitch settings return to their defaults if they are changed, when the machine is turned off or a different stitch is selected before the stitch setting is saved, refer to "Saving stitch settings" on page B-41.

## Setting the stitch width

The stitch width (zigzag width) can be adjusted to make the stitch wider or narrower.

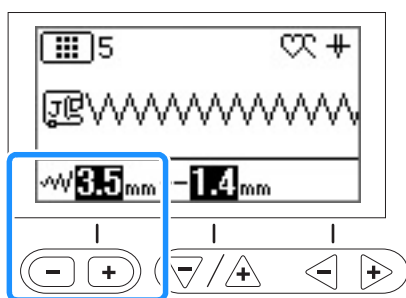

Each press of "-" makes the zigzag stitch narrower.

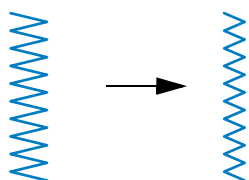

Each press of "+" makes the zigzag stitch wider.

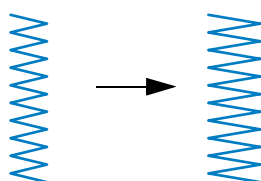

### Memo

- Press to return the setting to its default.
- If the straight stitch (left needle position or triple stretch stitch) was selected, changing the stitch width changes the needle position. Increasing the width moves the needle to the right; reducing the width moves the needle to the left.
- means the setting cannot be adjusted.

## CAUTION

- After adjusting the stitch width, slowly turn the handwheel toward you (counterclockwise) and check that the needle does not touch the presser foot. If the needle hits the presser foot, the needle may bend or break.

## Setting the stitch length

The stitch length can be adjusted to make the stitch coarser (longer) or finer (shorter).

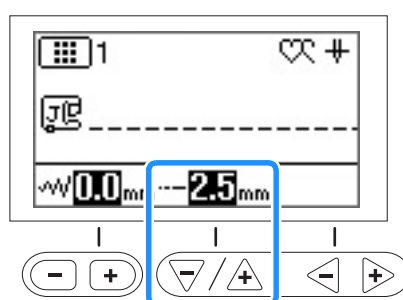

Each press of "-" makes the stitch finer (shorter).

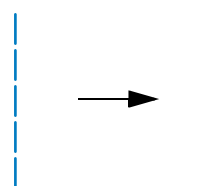

Each press of "+" makes the stitch coarser (longer).

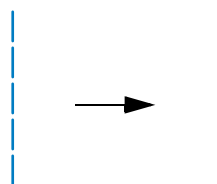

### Memo

- Press to return the setting to its default.
- means the setting cannot be adjusted.



## Setting the thread tension

You may need to change the thread tension, depending on the fabric and thread being used.

### Correct thread tension

The upper thread and the bobbin thread should cross near the center of the fabric. Only the upper thread should be visible from the right side of the fabric, and only the bobbin thread should be visible from the wrong side of the fabric.

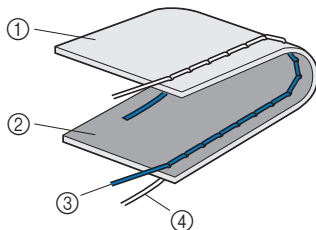

- ① Wrong side of fabric
- ② Right side of fabric
- ③ Upper thread
- ④ Bobbin thread

### Upper thread is too tight

If the bobbin thread is visible from the right side of the fabric, the upper thread is too tight. Loosen the thread tension.



#### Note

- If the bobbin thread was incorrectly threaded, the upper thread may be too tight. In this case, refer to “Installing the bobbin” on page B-18 and rethread the bobbin thread.

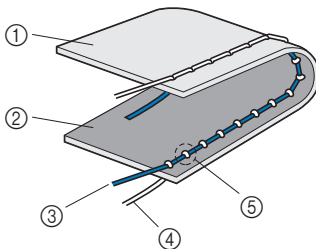

- ① Wrong side of fabric
- ② Right side of fabric
- ③ Upper thread
- ④ Bobbin thread
- ⑤ The bobbin thread is visible from the right side of the fabric.

### Upper thread is too loose

If the upper thread is visible from the wrong side of the fabric, the upper thread is too loose. Tighten the thread tension.



#### Note

- If the upper thread was incorrectly threaded, the upper thread may be too loose. In this case, refer to “Upper Threading” on page B-21 and rethread the upper thread.

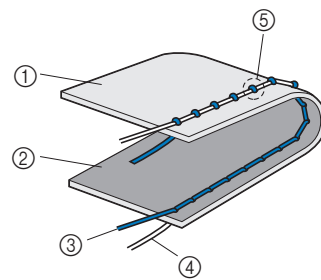

- ① Wrong side of fabric
- ② Right side of fabric
- ③ Upper thread
- ④ Bobbin thread
- ⑤ The upper thread is visible from the wrong side of the fabric.



#### Note

- If the upper thread is not threaded correctly or the bobbin is not installed correctly, it may not be possible to set the correct thread tension. If the correct thread tension cannot be achieved, rethread the upper thread and insert the bobbin correctly.

### Adjusting the thread tension

**Using thread tension key (For models equipped with thread tension key. Refer to page B-8)**

Use the “-” and “+” keys.

Each time the “-” key is pressed less tension is applied.

Each time the “+” key is pressed more tension is applied.

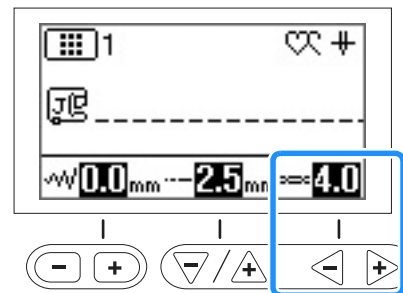

#### Memo

- Press  to return the setting to its default.

**Using thread tension dial (For models equipped with thread tension dial. Refer to page B-8)**

Pushing the thread tension dial toward the left makes the thread tension looser.

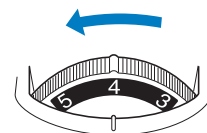

Pushing the thread tension dial toward the right makes the thread tension tighter.

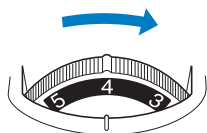

## Saving stitch settings

If you wish to save specific settings for a stitch so that they can be used later, press  after changing the settings to save the new settings with the selected stitch.

This feature can be used only with utility stitches.



To use a stitch length of 2.0 mm for the straight stitch

**1** Select a straight stitch.

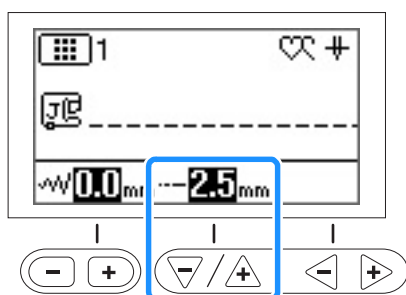
**2** Set the stitch length to 2.0 mm.



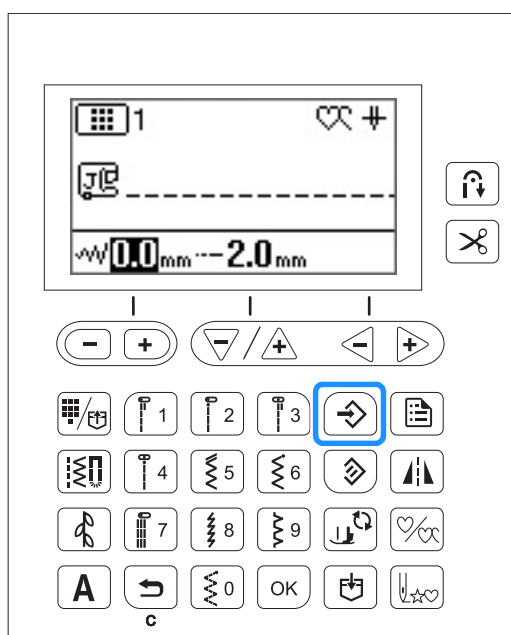

**3** Press .

- To reset the selected stitch pattern back to its default settings, press , and then press .



## Note



- The next time that the same straight stitch is selected, the stitch length is set to 2.0 mm.
- Both of the stitch width (zigzag width) and stitch length are saved, not just the setting that was changed. With models equipped with the thread tension keys, the setting for upper thread tension is also saved, even if it was not changed. When the same stitch pattern is selected, the last settings saved are displayed even if the machine was turned off. If the settings are changed again, or if  is pressed to reset the setting to its default, the new settings are not saved unless  is pressed another time.

Even if  is pressed, the settings for programmed thread cutting and automatic reverse/reinforcement stitching cannot be reset.

## Useful Functions

### Automatically cutting the thread

The machine can be set to automatically cut the threads at the end of the stitching. This is called “programmed thread-cutting”. If programmed thread-cutting is set, automatic reverse/reinforcement stitching is also set.



**1 Turn on the machine.**

**2 Select a stitch.**

- For details on selecting a stitch, refer to “Selecting a stitch pattern” on page B-34.

**3 Press .**





→  and  are lit, and the machine is set for programmed thread-cutting and automatic reverse/reinforcement stitching.

- To turn programmed thread cutting off, press .

**4 Set the fabric in place, and press the “Start/Stop” button once.**

→ Stitching will begin after reverse stitches or reinforcement stitches are sewn.

**5 Once you have reached the end of the stitching, press  (Reverse stitch button) or  (Reinforcement stitch button) once.**



If stitching, such as buttonholes and bar tacking, that includes reinforcement stitching has been selected, this operation is unnecessary.

→ After the reverse stitching or reinforcement stitching has been done, the machine stops, and the thread is cut.



- 1 The point where the “Start/Stop” button was pressed.
- 2 The point where  (Reverse stitch button) or  (Reinforcement stitch button) was pressed.
- 3 The thread is cut here.

### Memo

- Programmed thread-cutting will not be performed if the “Start/Stop” button is pressed while sewing.
- Press  (Reverse stitch button) or  (Reinforcement stitch button) at the end of the stitching.
- If the power is turned off, programmed thread-cutting will be turned off.

### Mirroring stitches

You can sew the mirror image of a stitch horizontally (left and right).

**1 Turn on the machine.**

**2 Select a stitch.**

- For details on selecting a stitch, refer to “Selecting a stitch pattern” on page B-34.

**3 Press .**

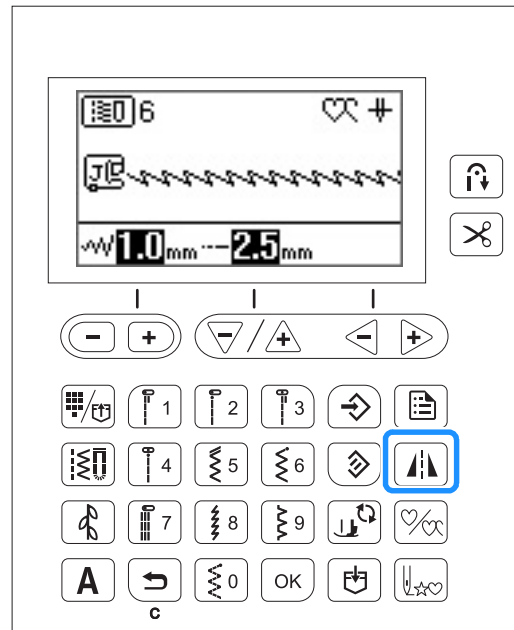

→  is displayed on the screen, and the pattern displayed on the screen is mirrored.

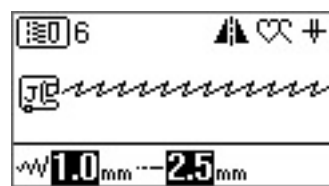

- To turn the mirrored stitching off, press  again.

### Memo

- Depending on the selected stitch, mirroring may not be possible; for example, buttonhole stitch.
- When the machine is turned off, the mirroring setting is cancelled.

## Adjusting the presser foot pressure

You can adjust the presser foot pressure (the amount of pressure applied to the fabric by the presser foot) on the settings screen. The higher the number, the greater the pressure will be. Set the pressure at "3" for normal sewing.

- 1 Select  (Presser foot pressure) in the settings screen.
- 2 Adjust the pressure by pressing the "-" or "+" key.

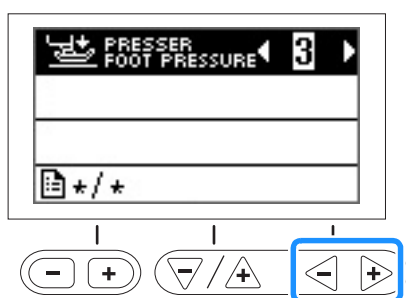

## Automatic Fabric Sensor System (Automatic presser foot pressure)

(For models equipped with automatic fabric sensor system. Refer to page B-8)

The thickness of the fabric is automatically detected and the presser foot pressure is automatically adjusted with an internal sensor while sewing, to insure that your fabric is fed smoothly. The fabric sensor system works continuously while sewing. This function is useful for sewing over thick seams or quilting. For details, refer to the "Sewing" section.

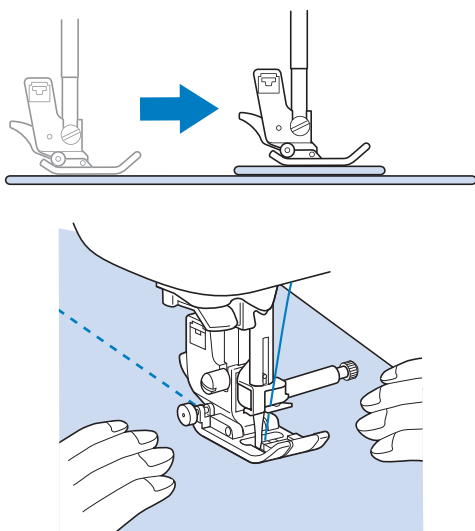

- 1 Select  (Automatic fabric sensor system) in the settings screen.
- 2 Set the sensor system to "ON" by pressing the "-" or "+" key.

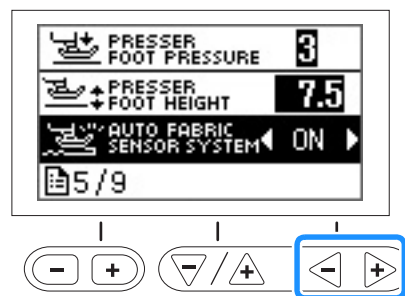

## Pivoting

(For models equipped with pivot function. Refer to page B-8)

If the pivot key is selected, the machine stops with the needle lowered (in the fabric) and the presser foot is automatically raised to an appropriate height when the "Start/Stop" button is pressed. When the "Start/Stop" button is pressed again, the presser foot is automatically lowered and sewing continues. This function is useful for stopping the machine to rotate the fabric.

### CAUTION

- When the pivot key is selected, the machine will begin stitching when the "Start/Stop" button is pressed or the foot controller is pressed down even if the presser foot has been raised by pressing  (presser foot lifter button). Be sure to keep your hands and other items away from the needle, otherwise injuries may occur.

### Memo

- When the pivot key is selected, the height of the presser foot when sewing is stopped can be changed according to the type of fabric being sewn. Select  (Pivoting height) in the settings screen. Press the "-" or "+" key to select one of the three heights (3.2 mm, 5.0 mm or 7.5 mm). Generally 3.2 mm is the preferred setting.

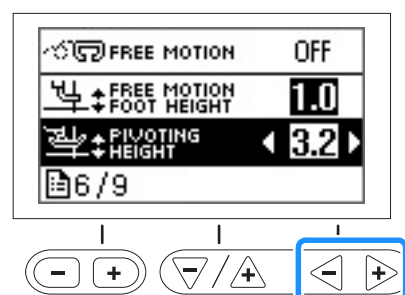

**Note**

- $\updownarrow$  (Needle position) in the settings screen, must be set to the down position for the pivot function to be used. When  $\updownarrow$  (Needle position) is set in the raised position,  $\updownarrow$  cannot be used. The pivot function can only be used with stitches where presser foot J or N is indicated on the screen. If any other stitch is selected,  $\updownarrow$  is not available.
- Use  $\updownarrow$  (Presser foot lifter button) to make sure the presser foot is lowered, and then press the “Start/Stop” button to continue sewing.
- If the pivot key is selected,  $\updownarrow$  (Presser foot height) setting in the settings screen can not be changed.

**1** Select a stitch.

**2** Press  $\updownarrow$  to select the pivot function.



→ The key will be lit.

**3** Place the fabric under the presser foot with the needle at the starting point of the stitching, lower the presser foot and then press the “Start/Stop” button. The machine will begin sewing.

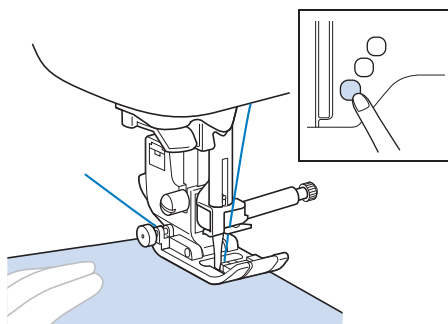

**Memo**

- If you press the “Start/Stop” button to pause sewing, press it again to continue, reverse stitches (or reinforcement stitches) will not be sewn.

**4** Press the “Start/Stop” button to stop the machine at the point where the sewing direction changes.

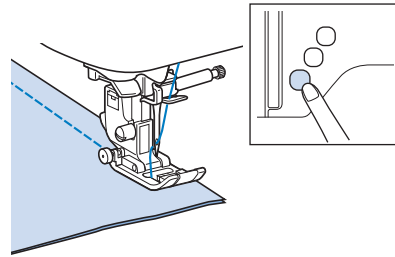

→ The machine stops with the needle in the fabric, and the presser foot is raised.

**5** Rotate the fabric, and then press the “Start/Stop” button.

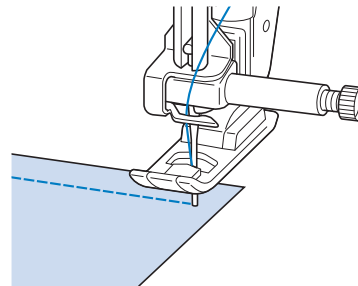

→ The presser foot is automatically lowered, and sewing continues.

**Sewing with free motion mode**

**(For models equipped with free motion mode. Refer to page B-8)**

With free motion mode, the presser foot is raised to the necessary height for free motion sewing. When starting to sew, the internal sensor detects the thickness of the fabric, and the quilting foot is raised to the height specified in the machine settings screen.

In free motion mode, lower the feed dogs (using the feed dog position switch) so that the fabric can be moved freely in any direction.

**Setting the machine to free motion mode**

**1** Select a stitch pattern.

**2** Select  $\updownarrow$  (Free motion) in the settings screen.

**3** Set the free motion mode to “ON” by pressing the “-” or “+” key.

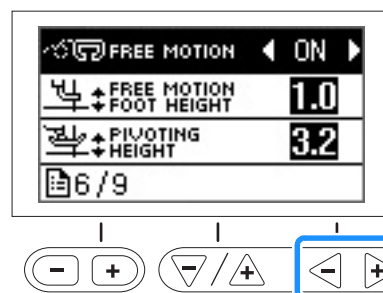

## ⚠ CAUTION

- With free motion quilting, control the feeding speed of the fabric to match the sewing speed. If the fabric is moved faster than the sewing speed, the needle may break or other damage may result.

### ■ Adjusting free motion presser foot height

- 1 Select  (Free motion foot height) in the settings screen.
- 2 Adjust the height that the quilting foot is raised above the fabric by pressing the “-” or “+” key.
  - Increase the setting by pressing “+”, for example, when sewing very stretchy fabric, so that it is easier to sew.

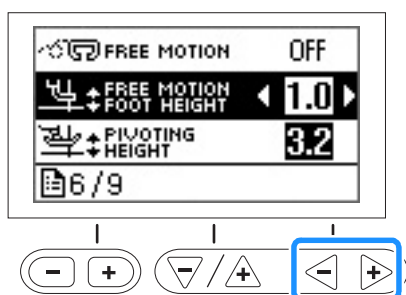

### Memo

- In order to sew with a balanced tension, it may be necessary to adjust the upper thread tension. For details, refer to “Setting the thread tension” on page B-40. Test with a sample piece of quilting fabric.

### Hands-free raising and lifting of the presser foot

Using the knee lifter, you can raise and lower the presser foot with your knee, leaving both hands free to handle the fabric.



### ■ Installing the knee lifter

- 1 Turn off the machine.
- 2 Insert the knee lifter into the mounting slot on the front of the machine in the lower-right corner.
 

Align the tabs on the knee lifter with the notches in the mounting slot, and then insert the knee lifter as far as possible.

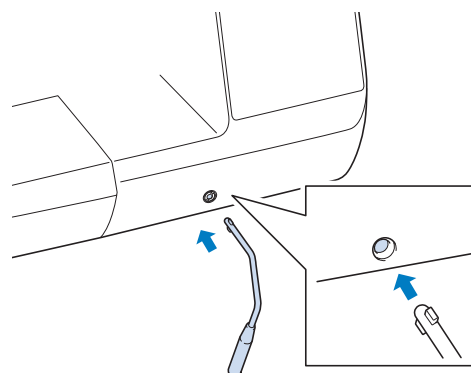

### Note

- If the knee lifter is not fully inserted into the mounting slot, it may fall out while the machine is operating.

### ■ Using the knee lifter

- 1 Stop the machine.
  - Do not use the knee lifter while the machine is operating.
- 2 With your knee, press the knee lifter to the right. Keep the knee lifter pressed to the right.

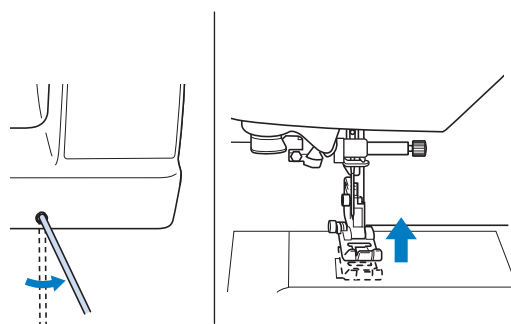

→ The presser foot is raised.

- 3 Release the knee lifter.
 

→ The presser foot is lowered.



## ⚠ CAUTION













- While sewing, keep your knee away from the knee lifter. If the knee lifter is pressed while the machine is operating, the needle may break or the machine may be damaged.

## Stitch Setting Chart

Applications, stitch lengths and widths and whether the twin needle can be used are listed for utility stitches in the following table.

This table applies to several models (Model 3, 2 and 1). Refer to the Quick Reference Guide for the model of your machine.

- \*1 Patterns printed on the numeric keys on the machine can be selected directly. For details, refer to “Preset utility stitches” on page B-52.
- \*2 For free motion quilting, use free motion open toe quilting foot “O” (sold separately with some models).
- \*3 When  (Automatic reverse/reinforcement key) is activated, the stitch will begin with reinforcement stitch.  
If  (Reinforcement priority) on the settings screen is also set to “ON”, the machine will sew reinforcement stitches at the end of stitching and then stop.
- \*4 For free motion quilting, use free motion quilting foot “C” (sold separately with some models) or free motion open toe quilting foot “O” (sold separately with some models).
- \*5 Do not sew reverse stitching when using the walking foot.

Stitch			Stitch name	Presser foot	Applications	Stitch width [mm (inch)]		Stitch length [mm (inch)]		Twin needle	Reverse/Reinforcement stitching	Walking foot
	Model 3, 2	Model 1				Auto.	Manual	Auto.	Manual			
	Stitch number											
	01* <sup>1</sup>	01* <sup>1</sup>	<b>Straight stitch (Left)</b>	J* <sup>2</sup>	General sewing, gather, pintuck, etc.	<b>0.0 (0)</b> 0.0 - 7.0 (0 - 1/4)	<b>2.5 (3/32)</b> 0.2 - 5.0 (1/64 - 3/16)	OK (J)	Reverse	OK* <sup>5</sup>		
	02* <sup>1</sup>	02* <sup>1</sup>	<b>Straight stitch (Left)</b>	J* <sup>2</sup>	General sewing, gather, pintuck, etc.	<b>0.0 (0)</b> 0.0 - 7.0 (0 - 1/4)	<b>2.5 (3/32)</b> 0.2 - 5.0 (1/64 - 3/16)	OK (J)	Reverse* <sup>3</sup>	OK* <sup>5</sup>		
	03* <sup>1</sup>	03* <sup>1</sup>	<b>Straight stitch (Middle)</b>	J* <sup>2</sup>	General sewing, gather, pintuck, etc.	<b>3.5 (1/8)</b> 0.0 - 7.0 (0 - 1/4)	<b>2.5 (3/32)</b> 0.2 - 5.0 (1/64 - 3/16)	OK (J)	Reverse	OK* <sup>5</sup>		
	04* <sup>1</sup>	04* <sup>1</sup>	<b>Straight stitch (Middle)</b>	J* <sup>2</sup>	General sewing, gather, pintuck, etc.	<b>3.5 (1/8)</b> 0.0 - 7.0 (0 - 1/4)	<b>2.5 (3/32)</b> 0.2 - 5.0 (1/64 - 3/16)	OK (J)	Reverse* <sup>3</sup>	OK* <sup>5</sup>		
	05* <sup>1</sup>	05* <sup>1</sup>	<b>Triple stretch stitch</b>	J* <sup>2</sup>	General sewing for reinforcement and decorative topstitching	<b>0.0 (0)</b> 0.0 - 7.0 (0 - 1/4)	<b>2.5 (3/32)</b> 0.4 - 5.0 (1/64 - 3/16)	OK (J)	Reinforcement	NO		
	06* <sup>1</sup>	06* <sup>1</sup>	<b>Stem stitch</b>	J* <sup>2</sup>	Reinforced stitching, sewing and decorative applications	<b>1.0 (1/16)</b> 0.0 - 7.0 (0 - 1/4)	<b>2.5 (3/32)</b> 0.4 - 5.0 (1/64 - 3/16)	OK (J)	Reinforcement	NO		
	07	-	<b>Decorative stitch</b>	N* <sup>2</sup>	Decorative stitching, top stitching	<b>0.0 (0)</b> 0.0 - 7.0 (0 - 1/4)	<b>2.5 (3/32)</b> 0.4 - 5.0 (1/64 - 3/16)	OK (J)	Reinforcement	NO		
	08	07	<b>Basting stitch</b>	J* <sup>2</sup>	Basting	<b>0.0 (0)</b> 0.0 - 7.0 (0 - 1/4)	Model 3, 2: <b>20 (3/4)</b> 5 - 30 (3/16 - 1-3/16) Model 1: -	NO	Reinforcement	NO		
	09* <sup>1</sup>	08* <sup>1</sup>	<b>Zigzag stitch</b>	J* <sup>2</sup>	For overcasting, mending.	<b>3.5 (1/8)</b> 0.0 - 7.0 (0 - 1/4)	<b>1.4 (1/16)</b> 0.0 - 5.0 (0 - 3/16)	OK (J)	Reverse	OK* <sup>5</sup>		
	10* <sup>1</sup>	09* <sup>1</sup>	<b>Zigzag stitch</b>	J* <sup>2</sup>	For overcasting, mending.	<b>3.5 (1/8)</b> 0.0 - 7.0 (0 - 1/4)	<b>1.4 (1/16)</b> 0.0 - 5.0 (0 - 3/16)	OK (J)	Reverse* <sup>3</sup>	OK* <sup>5</sup>		
	11	10	<b>Zigzag stitch (Right)</b>	J* <sup>2</sup>	Start from right needle position, zigzag sew at left.	<b>3.5 (1/8)</b> 2.5 - 5.0 (3/32 - 3/16)	<b>1.4 (1/16)</b> 0.3 - 5.0 (1/64 - 3/16)	OK (J)	Reverse* <sup>3</sup>	OK* <sup>5</sup>		
	12	-	<b>Zigzag stitch (Left)</b>	J* <sup>2</sup>	Start from left needle position, zigzag sew at right.	<b>3.5 (1/8)</b> 2.5 - 5.0 (3/32 - 3/16)	<b>1.4 (1/16)</b> 0.3 - 5.0 (1/64 - 3/16)	OK (J)	Reverse* <sup>3</sup>	OK* <sup>5</sup>		











Stitch			Stitch name	Presser foot	Applications	Stitch width	Stitch length	Twin needle	Reverse/Reinforcement stitching	Walking foot
	Model 3, 2	Model 1				[mm (inch)]	[mm (inch)]			
	Stitch number					Auto. Manual	Auto. Manual			
	13	11	<b>2 steps elastic zigzag stitch</b>	J*2	Overcasting (medium weight and stretch fabrics), tape and elastic	<b>5.0 (3/16)</b> 0.0 - 7.0 (0 - 1/4)	<b>1.0 (1/16)</b> 0.2 - 5.0 (1/64 - 3/16)	OK (J)	Reverse*3	OK*5
	14*1	12*1	<b>3 steps elastic zigzag stitch</b>	J*2	Overcasting (medium, heavyweight and stretch fabrics), tape and elastic	<b>5.0 (3/16)</b> 0.0 - 7.0 (0 - 1/4)	<b>1.0 (1/16)</b> 0.2 - 5.0 (1/64 - 3/16)	OK (J)	Reverse*3	OK*5
	15*1	13*1	<b>Overcasting stitch</b>	G	Reinforcing of light and medium weight fabrics	<b>3.5 (1/8)</b> 2.5 - 5.0 (3/32 - 3/16)	<b>2.0 (1/16)</b> 0.4 - 5.0 (1/64 - 3/16)	NO	Reinforcement	NO
	16	14	<b>Overcasting stitch</b>	G	Reinforcing of heavyweight fabric	<b>5.0 (3/16)</b> 2.5 - 5.0 (3/32 - 3/16)	<b>2.5 (3/32)</b> 0.4 - 5.0 (1/64 - 3/16)	NO	Reinforcement	NO
	17	15	<b>Overcasting stitch</b>	G	Reinforcing of medium, heavyweight and easily friable fabrics or decorative stitching.	<b>5.0 (3/16)</b> 3.5 - 5.0 (1/8 - 3/16)	<b>2.5 (3/32)</b> 0.4 - 5.0 (1/64 - 3/16)	NO	Reinforcement	NO
	18	16	<b>Overcasting stitch</b>	J*2	Reinforced seaming of stretch fabric	<b>5.0 (3/16)</b> 0.0 - 7.0 (0 - 1/4)	<b>2.5 (3/32)</b> 0.4 - 5.0 (1/64 - 3/16)	OK (J)	Reinforcement	NO
	19	17	<b>Overcasting stitch</b>	J*2	Reinforcing of medium stretch fabric and heavyweight fabric, decorative stitching	<b>5.0 (3/16)</b> 0.0 - 7.0 (0 - 1/4)	<b>2.5 (3/32)</b> 0.4 - 5.0 (1/64 - 3/16)	OK (J)	Reinforcement	NO
	20	18	<b>Overcasting stitch</b>	J*2	Reinforcement of stretch fabric or decorative stitching	<b>4.0 (3/16)</b> 0.0 - 7.0 (0 - 1/4)	<b>4.0 (3/16)</b> 0.4 - 5.0 (1/64 - 3/16)	OK (J)	Reinforcement	NO
	21	19	<b>Overcasting stitch</b>	J*2	Stretch knit seam	<b>5.0 (3/16)</b> 0.0 - 7.0 (0 - 1/4)	<b>4.0 (3/16)</b> 0.4 - 5.0 (1/64 - 3/16)	NO	Reinforcement	NO
	22	-	<b>Single diamond overcast stitch</b>	J*2	Reinforcement and seaming stretch fabric	<b>6.0 (15/64)</b> 0.0 - 7.0 (0 - 1/4)	<b>3.0 (1/8)</b> 0.4 - 5.0 (1/64 - 3/16)	OK (J)	Reinforcement	NO
	23	-	<b>Single diamond overcast stitch</b>	J*2	Reinforcement of stretch fabric	<b>6.0 (15/64)</b> 0.0 - 7.0 (0 - 1/4)	<b>1.8 (1/16)</b> 0.4 - 5.0 (1/64 - 3/16)	OK (J)	Reinforcement	NO
	24	20	<b>With side cutter</b>	S	Straight stitch while cutting fabrics	<b>0.0 (0)</b> 0.0 - 2.5 (0 - 3/32)	<b>2.5 (3/32)</b> 0.2 - 5.0 (1/64 - 3/16)	NO	Reinforcement	NO
	25	21	<b>With side cutter</b>	S	Zigzag stitch while cutting fabrics	<b>3.5 (1/8)</b> 3.5 - 5.0 (1/8 - 3/16)	<b>1.4 (1/16)</b> 0.0 - 5.0 (0 - 3/16)	NO	Reinforcement	NO
	26	22	<b>With side cutter</b>	S	Overcasting stitch while cutting fabrics	<b>3.5 (1/8)</b> 3.5 - 5.0 (1/8 - 3/16)	<b>2.0 (1/16)</b> 0.4 - 5.0 (1/64 - 3/16)	NO	Reinforcement	NO
	27	23	<b>With side cutter</b>	S	Overcasting stitch while cutting fabrics	<b>5.0 (3/16)</b> 3.5 - 5.0 (1/8 - 3/16)	<b>2.5 (3/32)</b> 0.4 - 5.0 (1/64 - 3/16)	NO	Reinforcement	NO
	28	24	<b>With side cutter</b>	S	Overcasting stitch while cutting fabrics	<b>5.0 (3/16)</b> 3.5 - 5.0 (1/8 - 3/16)	<b>2.5 (3/32)</b> 0.4 - 5.0 (1/64 - 3/16)	NO	Reinforcement	NO
	29	25	<b>Piecing stitch (Right)</b>	J*2	Piecing/patchwork 6.5 mm (approx. 1/4 inch) right seam allowance	<b>5.5 (7/32)</b> 0.0 - 7.0 (0 - 1/4)	<b>2.0 (1/16)</b> 0.2 - 5.0 (1/64 - 3/16)	NO	Reverse*3	OK*5
	30	26	<b>Piecing stitch (Middle)</b>	J*4	Piecing/patchwork	—	<b>2.0 (1/16)</b> 0.2 - 5.0 (1/64 - 3/16)	NO	Reverse*3	OK*5



Stitch			Stitch name	Presser foot	Applications	Stitch width [mm (inch)]		Stitch length [mm (inch)]		Twin needle	Reverse/Reinforcement stitching	Walking foot
	Model 3, 2	Model 1				Auto. Manual	Auto. Manual					
	Stitch number											
	31	-	<b>Piecing stitch (Left)</b>	J*2	Piecework/patchwork 6.5 mm (approx. 1/4 inch) left seam allowance	<b>1.5 (1/16)</b> 0.0 - 7.0 (0 - 1/4)	<b>2.0 (1/16)</b> 0.2 - 5.0 (1/64 - 3/16)	NO	Reverse*3	OK*5		
	32	27	<b>Hand-look quilting stitch</b>	J*2	Quilting stitch made to look like hand quilting stitch	<b>0.0 (0)</b> 0.0 - 7.0 (0 - 1/4)	<b>2.5 (3/32)</b> 0.4 - 5.0 (1/64 - 3/16)	NO	Reinforcement	NO		
	33	28	<b>Quilting appliqué zigzag stitch</b>	J*2	Zigzag stitch for quilting and sewing on appliqué quilt pieces	<b>3.5 (1/8)</b> 0.0 - 7.0 (0 - 1/4)	<b>1.4 (1/16)</b> 0.0 - 5.0 (0 - 3/16)	NO	Reverse*3	OK*5		
	34	29	<b>Quilting appliqué stitch</b>	J*2	Quilting stitch for invisible appliqué or attaching binding	<b>1.5 (1/16)</b> 0.0 - 7.0 (0 - 1/4)	<b>1.8 (1/16)</b> 0.4 - 5.0 (1/64 - 3/16)	NO	Reinforcement	NO		
	35	30	<b>Quilting stippling stitch</b>	J*2	Background quilting	<b>7.0 (1/4)</b> 0.0 - 7.0 (0 - 1/4)	<b>1.6 (1/16)</b> 0.4 - 5.0 (1/64 - 3/16)	NO	Reinforcement	NO		
	36	31	<b>Blind hem stitch</b>	R	Hemming woven fabrics	<b>00</b> 3← - →3	<b>2.0 (1/16)</b> 0.4 - 5.0 (1/64 - 3/16)	NO	Reinforcement	NO		
	37	32	<b>Blind hem stretch stitch</b>	R	Hemming stretch fabric	<b>00</b> 3← - →3	<b>2.0 (1/16)</b> 0.4 - 5.0 (1/64 - 3/16)	NO	Reinforcement	NO		
	38	33	<b>Blanket stitch</b>	J	Appliqués, decorative blanket stitch	<b>3.5 (1/8)</b> 0.0 - 7.0 (0 - 1/4)	<b>2.5 (3/32)</b> 0.4 - 5.0 (1/64 - 3/16)	OK (J)	Reinforcement	NO		
	39	34	<b>Shell tuck edge stitch</b>	J*2	Shell tuck edge finish on fabrics	<b>4.0 (3/16)</b> 0.0 - 7.0 (0 - 1/4)	<b>2.5 (3/32)</b> 0.2 - 5.0 (1/64 - 3/16)	OK (J)	Reinforcement	NO		
	40	35	<b>Satin scallop stitch</b>	N*2	Decorating collar of blouse, edge of handkerchief	<b>5.0 (3/16)</b> 0.0 - 7.0 (0 - 1/4)	<b>0.5 (1/32)</b> 0.1 - 5.0 (1/64 - 3/16)	OK (J)	Reinforcement	NO		
	41	-	<b>Scallop stitch</b>	N*2	Decorating collar of blouse, edge of handkerchief	<b>7.0 (1/4)</b> 0.0 - 7.0 (0 - 1/4)	<b>1.4 (1/16)</b> 0.4 - 5.0 (1/64 - 3/16)	NO	Reinforcement	NO		
	42	36	<b>Patchwork join stitch</b>	J*2	Patchwork stitches, decorative stitching	<b>4.0 (3/16)</b> 0.0 - 7.0 (0 - 1/4)	<b>1.2 (1/16)</b> 0.2 - 5.0 (1/64 - 3/16)	OK (J)	Reinforcement	NO		
	43	37	<b>Patchwork double overlock stitch</b>	J*2	Patchwork stitches, decorative stitching	<b>5.0 (3/16)</b> 0.0 - 7.0 (0 - 1/4)	<b>2.5 (3/32)</b> 0.4 - 5.0 (1/64 - 3/16)	OK (J)	Reinforcement	NO		
	44	38	<b>Couching stitch</b>	J*2	Decorative stitching, attaching cord and couching	<b>5.0 (3/16)</b> 0.0 - 7.0 (0 - 1/4)	<b>1.2 (1/16)</b> 0.2 - 5.0 (1/64 - 3/16)	OK (J)	Reinforcement	NO		
	45	39	<b>Smocking stitch</b>	J*2	Smocking, decorative stitching	<b>5.0 (3/16)</b> 0.0 - 7.0 (0 - 1/4)	<b>1.6 (1/16)</b> 0.4 - 5.0 (1/64 - 3/16)	OK (J)	Reinforcement	NO		
	46	40	<b>Feather stitch</b>	J*2	Fagoting, decorative stitching	<b>5.0 (3/16)</b> 0.0 - 7.0 (0 - 1/4)	<b>2.5 (3/32)</b> 0.4 - 5.0 (1/64 - 3/16)	OK (J)	Reinforcement	NO		
	47	41	<b>Fagoting cross stitch</b>	J*2	Fagoting, bridging and decorative stitching	<b>5.0 (3/16)</b> 0.0 - 7.0 (0 - 1/4)	<b>2.5 (3/32)</b> 0.4 - 5.0 (1/64 - 3/16)	OK (J)	Reinforcement	NO		
	48	42	<b>Tape attaching stitch</b>	J*2	Attaching tape to seam in stretch fabric	<b>4.0 (3/16)</b> 0.0 - 7.0 (0 - 1/4)	<b>1.0 (1/16)</b> 0.2 - 5.0 (1/64 - 3/16)	OK (J)	Reinforcement	NO		
	49	43	<b>Ladder stitch</b>	J*2	Decorative stitching	<b>4.0 (3/16)</b> 0.0 - 7.0 (0 - 1/4)	<b>3.0 (1/8)</b> 0.4 - 5.0 (1/64 - 3/16)	NO	Reinforcement	NO		
	50	44	<b>Rick-rack stitch</b>	J*2	Decorative top stitching	<b>4.0 (3/16)</b> 0.0 - 7.0 (0 - 1/4)	<b>2.5 (3/32)</b> 0.4 - 5.0 (1/64 - 3/16)	OK (J)	Reinforcement	NO		

Stitch			Stitch name	Presser foot	Applications	Stitch width	Stitch length	Twin needle	Reverse/Reinforcement stitching	Walking foot
	Model 3, 2	Model 1				[mm (inch)]	[mm (inch)]			
	Stitch number					Auto. Manual	Auto. Manual			
	51	45	<b>Decorative stitch</b>	J*2	Decorative stitching	<b>5.5 (7/32)</b> 0.0 - 7.0 (0 - 1/4)	<b>1.6 (1/16)</b> 0.4 - 5.0 (1/64 - 3/16)	OK (J)	Reinforcement	NO
	52	46	<b>Serpentine stitch</b>	N*2	Decorative stitching and attaching elastic	<b>5.0 (3/16)</b> 0.0 - 7.0 (0 - 1/4)	<b>1.0 (1/16)</b> 0.2 - 5.0 (1/64 - 3/16)	OK (J)	Reinforcement	NO
	53	-	<b>Decorative stitch</b>	N*2	Decorative stitching and appliqué	<b>6.0 (15/64)</b> 0.0 - 7.0 (0 - 1/4)	<b>1.0 (1/16)</b> 0.2 - 5.0 (1/64 - 3/16)	OK (J)	Reinforcement	NO
	54	-	<b>Decorative stippling stitch</b>	N*2	Decorative stitching	<b>7.0 (1/4)</b> 0.0 - 7.0 (0 - 1/4)	<b>1.6 (1/16)</b> 0.4 - 5.0 (1/64 - 3/16)	NO	Reinforcement	NO
	55	-	<b>Hemstitching</b>	N*2	Decorative hems, triple straight at left	<b>1.0 (1/16)</b> 0.0 - 7.0 (0 - 1/4)	<b>2.5 (3/32)</b> 0.4 - 5.0 (1/64 - 3/16)	OK (J)	Reinforcement	NO
	56	-	<b>Hemstitching</b>	N*2	Decorative hems, triple straight at center	<b>3.5 (1/8)</b> 0.0 - 7.0 (0 - 1/4)	<b>2.5 (3/32)</b> 0.4 - 5.0 (1/64 - 3/16)	OK (J)	Reinforcement	NO
	57	47	<b>Hemstitching zigzag</b>	N*2	Decorative hems, top stitching	<b>6.0 (15/64)</b> 0.0 - 7.0 (0 - 1/4)	<b>3.0 (1/8)</b> 0.4 - 5.0 (1/64 - 3/16)	OK (J)	Reinforcement	NO
	58	48	<b>Hemstitching</b>	N*2	Decorative hems, lace attaching pin stitch	<b>3.5 (1/8)</b> 0.0 - 7.0 (0 - 1/4)	<b>2.5 (3/32)</b> 0.4 - 5.0 (1/64 - 3/16)	NO	Reinforcement	NO
	59	49	<b>Hemstitching</b>	N*2	Decorative hems	<b>3.0 (1/8)</b> 0.0 - 7.0 (0 - 1/4)	<b>3.5 (1/8)</b> 0.4 - 5.0 (1/64 - 3/16)	NO	Reinforcement	NO
	60	50	<b>Hemstitching</b>	N*2	Decorative hems daisy stitch	<b>6.0 (15/64)</b> 0.0 - 7.0 (0 - 1/4)	<b>3.0 (1/8)</b> 0.4 - 5.0 (1/64 - 3/16)	NO	Reinforcement	NO
	61	-	<b>Hemstitching</b>	N*2	Heirloom, decorative hems	<b>5.0 (3/16)</b> 0.0 - 7.0 (0 - 1/4)	<b>3.5 (1/8)</b> 0.4 - 5.0 (1/64 - 3/16)	NO	Reinforcement	NO
	62	51	<b>Hemstitching</b>	N*2	Heirloom, decorative hems	<b>5.0 (3/16)</b> 0.0 - 7.0 (0 - 1/4)	<b>3.5 (1/8)</b> 0.4 - 5.0 (1/64 - 3/16)	NO	Reinforcement	NO
	63	-	<b>Hemstitching</b>	N*2	Heirloom, decorative hems	<b>5.0 (3/16)</b> 0.0 - 7.0 (0 - 1/4)	<b>3.5 (1/8)</b> 0.4 - 5.0 (1/64 - 3/16)	OK (J)	Reinforcement	NO
	64	52	<b>Hemstitching</b>	N*2	Heirloom, decorative hems	<b>5.0 (3/16)</b> 0.0 - 7.0 (0 - 1/4)	<b>4.0 (3/16)</b> 0.4 - 5.0 (1/64 - 3/16)	OK (J)	Reinforcement	NO
	65	-	<b>Hemstitching</b>	N*2	Heirloom, decorative hems	<b>4.0 (3/16)</b> 0.0 - 7.0 (0 - 1/4)	<b>2.5 (3/32)</b> 0.4 - 5.0 (1/64 - 3/16)	OK (J)	Reinforcement	NO
	66	-	<b>Honeycomb stitch</b>	N*2	Heirloom, decorative hems	<b>5.0 (3/16)</b> 0.0 - 7.0 (0 - 1/4)	<b>2.5 (3/32)</b> 0.4 - 5.0 (1/64 - 3/16)	OK (J)	Reinforcement	NO
	67	-	<b>Honeycomb stitch</b>	N*2	Heirloom, decorative hems	<b>6.0 (15/64)</b> 0.0 - 7.0 (0 - 1/4)	<b>3.5 (1/8)</b> 0.4 - 5.0 (1/64 - 3/16)	OK (J)	Reinforcement	NO
	68	53	<b>Hemstitching</b>	N*2	Heirloom, decorative hems	<b>6.0 (15/64)</b> 0.0 - 7.0 (0 - 1/4)	<b>1.6 (1/16)</b> 0.4 - 5.0 (1/64 - 3/16)	OK (J)	Reinforcement	NO
	69	54	<b>Hemstitching</b>	N*2	Heirloom, decorative hems	<b>6.0 (15/64)</b> 0.0 - 7.0 (0 - 1/4)	<b>3.0 (1/8)</b> 0.4 - 5.0 (1/64 - 3/16)	NO	Reinforcement	NO
	70	-	<b>Hemstitching</b>	N*2	Heirloom, decorative hems	<b>6.0 (15/64)</b> 0.0 - 7.0 (0 - 1/4)	<b>4.0 (3/16)</b> 0.4 - 5.0 (1/64 - 3/16)	OK (J)	Reinforcement	NO













Stitch			Stitch name	Presser foot	Applications	Stitch width [mm (inch)]	Stitch length [mm (inch)]	Twin needle	Reverse/Reinforcement stitching	Walking foot
	Model 3, 2	Model 1				Auto. Manual	Auto. Manual			
	Stitch number									
	71	55	<b>Hemstitching</b>	N*2	Heirloom, decorative hems	<b>4.0 (3/16)</b> 0.0 - 7.0 (0 - 1/4)	<b>2.5 (3/32)</b> 0.4 - 5.0 (1/64 - 3/16)	NO	Reinforcement	NO
	72	56	<b>Hemstitching</b>	N*2	Heirloom, decorative hems	<b>5.0 (3/16)</b> 0.0 - 7.0 (0 - 1/4)	<b>2.0 (1/16)</b> 0.4 - 5.0 (1/64 - 3/16)	OK (J)	Reinforcement	NO
	73	-	<b>Hemstitching</b>	N*2	Decorative hems and bridging stitch	<b>6.0 (15/64)</b> 0.0 - 7.0 (0 - 1/4)	<b>2.0 (1/16)</b> 0.4 - 5.0 (1/64 - 3/16)	OK (J)	Reinforcement	NO
	74	-	<b>Hemstitching</b>	N*2	Decorative hems. Fagoting, attaching ribbon	<b>5.0 (3/16)</b> 0.0 - 7.0 (0 - 1/4)	<b>3.0 (1/8)</b> 0.4 - 5.0 (1/64 - 3/16)	OK (J)	Reinforcement	NO
	75	-	<b>Hemstitching</b>	N*2	Decorative hems, smocking	<b>6.0 (15/64)</b> 0.0 - 7.0 (0 - 1/4)	<b>1.6 (1/16)</b> 0.4 - 5.0 (1/64 - 3/16)	NO	Reinforcement	NO
	76	-	<b>Hemstitching</b>	N*2	Decorative hems, smocking	<b>5.0 (3/16)</b> 0.0 - 7.0 (0 - 1/4)	<b>1.6 (1/16)</b> 0.4 - 5.0 (1/64 - 3/16)	NO	Reinforcement	NO
	77	57	<b>Narrow rounded buttonhole stitch</b>	A	Buttonhole on light to medium weight fabrics	<b>5.0 (3/16)</b> 3.0 - 5.0 (1/8 - 3/16)	<b>0.4 (1/64)</b> 0.2 - 1.0 (1/64 - 1/16)	NO	Automatic reinforcement	NO
	78	58	<b>Tapered round ended buttonhole stitch</b>	A	Reinforced waist tapered buttonholes	<b>5.0 (3/16)</b> 3.0 - 5.0 (1/8 - 3/16)	<b>0.4 (1/64)</b> 0.2 - 1.0 (1/64 - 1/16)	NO	Automatic reinforcement	NO
	79	59	<b>Round ended buttonhole stitch</b>	A	Buttonholes with vertical bar tack in heavyweight fabrics	<b>5.0 (3/16)</b> 3.0 - 5.0 (1/8 - 3/16)	<b>0.4 (1/64)</b> 0.2 - 1.0 (1/64 - 1/16)	NO	Automatic reinforcement	NO
	80	60	<b>Narrow squared buttonhole stitch</b>	A	Buttonholes for light to medium weight fabrics	<b>5.0 (3/16)</b> 3.0 - 5.0 (1/8 - 3/16)	<b>0.4 (1/64)</b> 0.2 - 1.0 (1/64 - 1/16)	NO	Automatic reinforcement	NO
	81	61	<b>Stretch buttonhole stitch</b>	A	Buttonholes for stretch or woven fabrics	<b>6.0 (15/64)</b> 3.0 - 6.0 (1/8 - 15/64)	<b>1.0 (1/16)</b> 0.5 - 2.0 (1/32 - 1/16)	NO	Automatic reinforcement	NO
	82	62	<b>Heirloom buttonhole stitch</b>	A	Buttonholes for heirloom and stretch fabrics	<b>6.0 (15/64)</b> 3.0 - 6.0 (1/8 - 15/64)	<b>1.5 (1/16)</b> 1.0 - 3.0 (1/16 - 1/8)	NO	Automatic reinforcement	NO
	83	63	<b>Bound buttonhole stitch</b>	A	The first step in making bound buttonholes	<b>5.0 (3/16)</b> 0.0 - 6.0 (0 - 15/64)	<b>2.0 (1/16)</b> 0.2 - 4.0 (1/64 - 3/16)	NO	Automatic reinforcement	NO
	84	64	<b>Keyhole buttonhole stitch</b>	A	Buttonholes in heavyweight or thick fabrics for larger flat buttons	<b>7.0 (1/4)</b> 3.0 - 7.0 (1/8 - 1/4)	<b>0.5 (1/32)</b> 0.3 - 1.0 (1/64 - 1/16)	NO	Automatic reinforcement	NO
	85	65	<b>Tapered keyhole buttonhole stitch</b>	A	Buttonholes in medium to heavy weight fabrics for larger flat buttons	<b>7.0 (1/4)</b> 3.0 - 7.0 (1/8 - 1/4)	<b>0.5 (1/32)</b> 0.3 - 1.0 (1/64 - 1/16)	NO	Automatic reinforcement	NO
	86	66	<b>Keyhole buttonhole stitch</b>	A	Buttonholes with vertical bar tack for reinforcement in heavyweight or thick fabrics	<b>7.0 (1/4)</b> 3.0 - 7.0 (1/8 - 1/4)	<b>0.5 (1/32)</b> 0.3 - 1.0 (1/64 - 1/16)	NO	Automatic reinforcement	NO
	87	67	<b>Darning stitch</b>	A	Darning of medium weight fabric	<b>7.0 (1/4)</b> 2.5 - 7.0 (3/32 - 1/4)	<b>2.0 (1/16)</b> 0.4 - 2.5 (1/64 - 3/32)	NO	Automatic reinforcement	NO
	88	68	<b>Darning stitch</b>	A	Darning of heavyweight fabric	<b>7.0 (1/4)</b> 2.5 - 7.0 (3/32 - 1/4)	<b>2.0 (1/16)</b> 0.4 - 2.5 (1/64 - 3/32)	NO	Automatic reinforcement	NO

Stitch			Stitch name	Presser foot	Applications	Stitch width [mm (inch)]	Stitch length [mm (inch)]	Twin needle	Reverse/Reinforcement stitching	Walking foot
	Model 3, 2	Model 1				Auto. Manual	Auto. Manual			
	Stitch number									
	89	69	<b>Bar tack stitch</b>	A	Reinforcement at opening of pocket, etc.	<b>2.0 (1/16)</b> 1.0 - 3.0 (1/16 - 1/8)	<b>0.4 (1/64)</b> 0.3 - 1.0 (1/64 - 1/16)	NO	Automatic reinforcement	NO
	90	70	<b>Button sewing stitch</b>	M	Attaching buttons	<b>3.5 (1/8)</b> 2.5 - 4.5 (3/32 - 3/16)	—	NO	Reinforcement	NO
	91	71	<b>Eyelet stitch</b>	N	For making eyelets, holes on belts, etc.	<b>7.0 (1/4)</b> 7.0 6.0 5.0 (1/4 15/64 3/16)	<b>7.0 (1/4)</b> 7.0 6.0 5.0 (1/4 15/64 3/16)	NO	Automatic reinforcement	NO
	92	-	<b>Reverse (Straight stitch)</b>	N	For attaching appliqué on tubular pieces of fabric and mitering corners	—	—	NO	Reinforcement	NO
	93	-	<b>Sideways to left (Straight stitch)</b>	N	For attaching appliqué on tubular pieces of fabric	—	—	NO	Reinforcement	NO
	94	-	<b>Sideways to right (Straight stitch)</b>	N	For attaching appliqué on tubular pieces of fabric	—	—	NO	Reinforcement	NO
	95	-	<b>Forward (Straight stitch)</b>	N	For attaching appliqué on tubular pieces of fabric and mitering corners	—	—	NO	Reinforcement	NO
	96	-	<b>Sideways to left (Zigzag stitch)</b>	N	For attaching appliqué on tubular pieces of fabric	—	—	NO	Reinforcement	NO
	97	-	<b>Sideways to right (Zigzag stitch)</b>	N	For attaching appliqué on tubular pieces of fabric	—	—	NO	Reinforcement	NO
	98	-	<b>Forward (Zigzag stitch)</b>	N	For attaching appliqué on tubular pieces of fabric and mitering corners	—	—	NO	Reinforcement	NO
	99	-	<b>Reverse (Zigzag stitch)</b>	N	For attaching appliqué on tubular pieces of fabric and mitering corners	—	—	NO	Reinforcement	NO

■ **Preset utility stitches**

The most frequently used utility stitches have been assigned to the numeric keys.

These stitches can be selected simply by pressing the designated key while in the preset utility stitch mode.

 Preset utility stitches	Stitch name		
		Model 3, 2	Model 1
		Stitch number	
 1	<b>Straight stitch (Left)</b>	01	01
 2	<b>Straight stitch (Left)</b>	02	02
 3	<b>Straight stitch (Middle)</b>	03	03
 4	<b>Straight stitch (Middle)</b>	04	04
 5	<b>Zigzag stitch</b>	09	08
 6	<b>Zigzag stitch</b>	10	09
 7	<b>Triple stretch stitch</b>	05	05
 8	<b>Stem stitch</b>	06	06
 9	<b>Overcasting stitch</b>	15	13
 0	<b>3 steps elastic zigzag stitch</b>	14	12



# Sewing

This section describes procedures for using the various utility stitches as well as other functions. It provides details on basic sewing in addition to the more expressive features of the machine, such as sewing tubular pieces and buttonholes.  
Page number starts with “S” in this section.

**Chapter1 SEWING ATTRACTIVE FINISHES..... S-2**

---

**Chapter2 UTILITY STITCHES..... S-6**

---

## CAUTION

- Before replacing the presser foot, be sure to press  (Presser foot/Needle exchange key) on the operation panel to lock all keys and buttons, otherwise injuries may occur if the “Start/Stop” button or any other button is pressed and the machine starts. For details on changing the presser foot, refer to “Replacing the Presser Foot” in the “Basic operations” section.

# Chapter 1 SEWING ATTRACTIVE FINISHES

## Sewing Tips

### Trial sewing

After you have set up the machine with the thread and needle appropriate for the type of fabric being sewn, the machine automatically sets the stitch length and width for the stitch that is selected. However, a trial piece of fabric should be sewn since, depending on the type of fabric and stitching being sewn, the desired results may not be achieved.

For the trial sewing, use a piece of fabric and thread that are the same as those used for your project, and check the thread tension and stitch length and width. Since the results differ depending on the type of stitching and the number of layers of fabric sewn, perform the trial sewing under the same conditions that will be used with your project.

### Changing the sewing direction

- 1 **When the stitching reaches a corner, stop the machine.**  
Leave the needle lowered (in the fabric). If the needle remains up when the machine stops sewing, press  (Needle position button) to lower the needle.
- 2 **Raise the presser foot lever, and then turn the fabric.**  
Turn the fabric using the needle as a pivot.

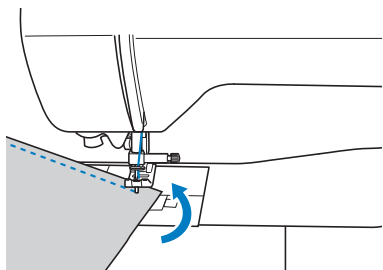

- 3 **Lower the presser foot lever and continue sewing.**

### Sewing curves

Stop sewing, and then slightly change the sewing direction to sew around the curve. For details on sewing with an even seam allowance, refer to “Sewing an even seam allowance” on page S-3.

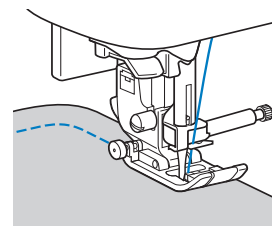

When sewing along a curve while using a zigzag stitch, select a shorter stitch length in order to obtain a finer stitch.

### Sewing cylindrical pieces

Removing the flat bed attachment allows for free-arm sewing, making it easier to sew cylindrical pieces such as sleeve cuffs and pant legs.

- 1 **Pull the flat bed attachment off to the left.**

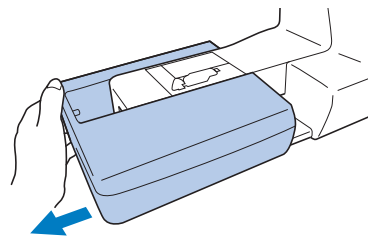

- 2 **Slide the part that you wish to sew onto the free arm, and then sew from the top.**

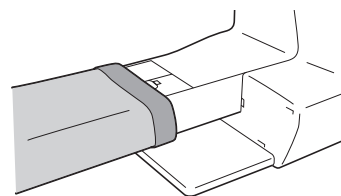

- 3 **When you are finished with free arm sewing, install the flat bed attachment back in its original position.**

## Sewing an even seam allowance

To sew an even seam, start sewing so that the seam allowance is to the right of the presser foot, and the edge of the fabric is aligned with either the right edge of the presser foot or a marking on the needle plate.

### ■ Aligning the fabric with the presser foot

Sew while keeping the right edge of the presser foot a fixed distance from the edge of the fabric.

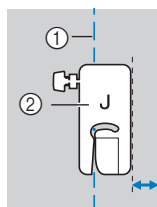

- ① Seam
- ② Presser foot

### ■ Aligning the fabric with the stitch guide foot (sold separately with some models)

Sew while keeping the right edge of the fabric aligned with a desired position of markings on the stitch guide foot.

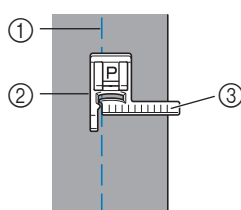

- ① Seam
- ② Stitch guide foot
- ③ Markings

### ■ Aligning the fabric with a needle plate marking

The markings on the needle plate show the distance from the needle position of a seam sewn with the straight stitch (left needle position). Sew while keeping the edge of the fabric aligned with a marking on the needle plate. The distance between the markings in the upper scale is 1/8 inch (3 mm) and the distance between the markings in the grid is 5 mm (3/16 inch).

For stitches with a left needle position  
(Stitch width: 0.0 mm)

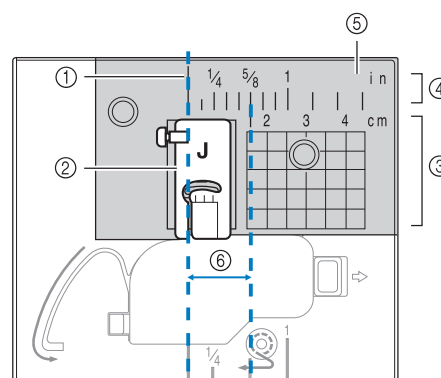

- ① Seam
- ② Presser foot
- ③ Centimeters
- ④ Inches
- ⑤ Needle plate
- ⑥ 1.6 cm (5/8 inch)



## Sewing Various Fabrics

### Sewing thick fabrics

#### ■ If the fabric does not fit under the presser foot

If the fabric does not fit easily under the presser foot, raise the presser foot lever even higher to bring the presser foot to its highest position.

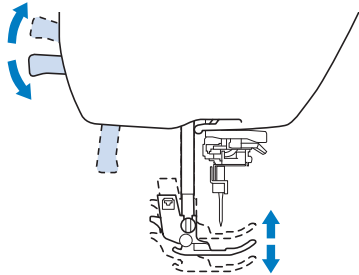

#### ■ If thick seams are being sewn and the fabric does not feed at the beginning of stitching

The fabric may not feed when thick seams are being sewn and the presser foot is not level, as shown below. In this case, use the presser foot locking pin (black button on the left side of zigzag foot “J”) so that the presser foot remains level while sewing, allowing the fabric to be fed smoothly.

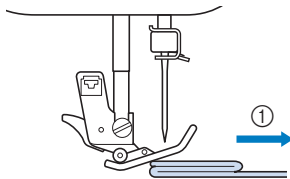

① Sewing direction

- 1 Raise the presser foot lever.
- 2 Align the beginning of stitching, and then position the fabric.
- 3 While holding zigzag foot “J” level, hold the presser foot locking pin (black button on the left side) pressed in, and lower the presser foot lever.

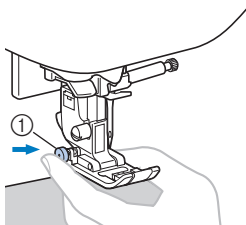

① Presser foot holding pin (black button)

#### 4 Release the presser foot locking pin (black button).

→ The presser foot remains level, allowing the fabric to be fed.

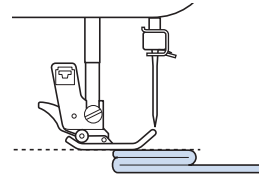

→ After the seam is sewn, the presser foot will return to its original angle.

#### Memo

- You may find adjusting the “Presser Foot Pressure” in the settings screen helpful on some thick fabrics.
- (For models equipped with Automatic Fabric Sensor System)  
When “Automatic Fabric Sensor System” in the settings screen is set to “ON”, the thickness of the fabric is automatically detected by the internal sensor so the fabric can be fed smoothly for best sewing results. For details on the automatic fabric sensor system, refer to “Automatic Fabric Sensor System (Automatic presser foot pressure)” in the “Basic operations” section.

## CAUTION

- If fabric more than 6 mm (15/64 inch) thick is sewn or if the fabric is pushed with too much force, the needle may bend or break.

### Sewing thin fabrics

When sewing thin fabrics, the stitching may become misaligned or the fabric may not feed correctly. Move the needle (be sure to use a fine needle) to the furthest left or right hand position so that the fabric does not get pulled down into the feed dog area. If this occurs, place thin paper or stabilizer material under the fabric and sew it together with the fabric. When you have finished sewing, tear off any excess paper.

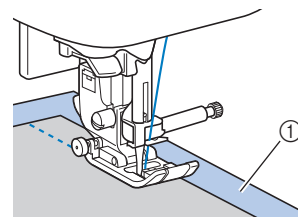

① Stabilizer material or paper





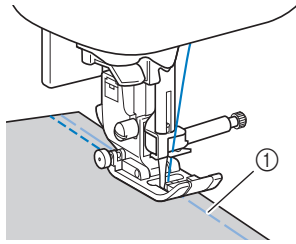

## Sewing stretch fabrics

First, baste the pieces of fabric together, and then sew without stretching the fabric.



① Basting

For best results when sewing on knit fabrics use the stretch stitches. Also be sure to use a needle for knits. The recommended stitches and their stitch numbers are indicated below.

Stitch					
Model 4	1-05	1-06	1-13	1-14	2-13
Model 3,2 	05*	06*	13	14*	48
Model 1 	05*	06*	11	12*	42

\* Stitch patterns can be selected directly by pressing the numeric keys on the machine during preset utility stitch mode. Refer to "Basic operations" section.

## Sewing leathers or vinyl fabrics

When sewing fabrics that may stick to the presser foot such as leathers or coated fabrics, change the presser foot to the non stick foot\*. The walking foot\* is also suitable for sewing some leathers or vinyl fabrics.

\* Sold separately with some models.

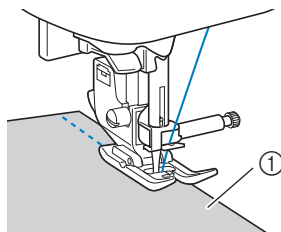

① Leather



### Note

- The walking foot can only be used with straight or zigzag stitch patterns with reinforcement stitches. For details, refer to "Stitch Setting Chart" in the "Basic operations" section.
- When using the walking foot, test sew on a scrap piece of leather or vinyl that is to be used in project to make sure foot does not leave any marks.

## Sewing hook-and-loop fastener tape

### ⚠ CAUTION

- Use only the adhesive-free hook-and-loop fastener tape which is designed for sewing. When the glue adheres to the needle or the bobbin hook race, it may cause malfunction.
- If the hook-and-loop fastener tape is sewn with the thin needle (65/9-75/11), the needle may bend or break.



### Note

- Before sewing, baste together the fabric and the hook-and-loop fastener tape.

Make sure that the needle passes through the hook-and-loop fastener tape by turning the handwheel and lower the needle into the hook-and-loop fastener tape before sewing. And then, sew the edge of the hook-and-loop fastener tape at a slow speed.

If the needle does not pass through the hook-and-loop fastener tape, replace the needle with the needle size for thicker fabrics. For details, refer to "Fabric/thread/needle combinations" in the "Basic operations" section.

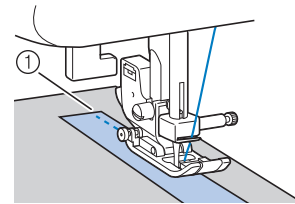

① Edge of the hook-and-loop fastener tape

# Chapter 2 UTILITY STITCHES

## Basic Stitching

Straight stitches are used for sewing plain seams.

- Using the table below, refer to "Using the utility stitch tables in the "Sewing" section" in the "Basic operations" section.

Stitch name	Stitch	Model 4	Model 3, 2		Presser foot
		Stitch number			
Model 1					
Basting stitch		1-08	08	07	J
Straight stitch (Left)		1-01	01*	01*	
		1-02	02*	02*	
Straight stitch (Middle)		1-03	03*	03*	
Straight stitch (Middle)		1-04	04*	04*	
Triple stretch stitch		1-05	05*	05*	

\* Stitch patterns can be selected directly by pressing the numeric keys on the machine during preset utility stitch mode. Refer to "Basic operations" section.

## Basting

When using Model 1: Sew basting with a stitch length of 5 mm (3/16 inch).

When using Model 2 or 3: Sew basting with a stitch length between 5 mm (3/16 inch) and 30 mm (1-3/16 inches).

- 1 Attach zigzag foot "J".

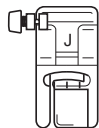

- 2 Select stitch

- 3 Start sewing.

## Basic stitching

- 1 Baste or pin together the fabric pieces.

- 2 Attach zigzag foot "J".

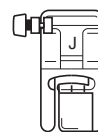

- 3 Select a stitch.

- 4 Lower the needle into the fabric at the beginning of the stitching.

- 5 Lower the presser foot lever, and then start sewing.

- 6 When sewing is finished, cut the thread.



## ■ Changing the needle position

The needle position used as the baseline is different for the straight stitch (left needle position) and the straight stitch (center needle position).

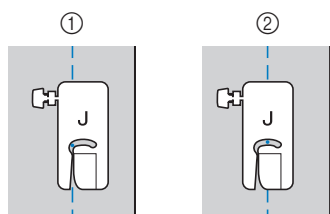

- ① Straight stitch (left needle position)
- ② Straight stitch (center needle position)

When the stitch width of the straight stitch (left needle position) is set to its standard setting (0.0 mm), the distance from the needle position to the right side of the presser foot is 12 mm (1/2 inch). If the stitch width is changed (between 0 and 7.0 mm (1/4 inch)), the needle position will also change. By changing the stitch width and sewing with the right side of the presser foot aligned with the edge of the fabric, a seam allowance can be sewn with a fixed width.

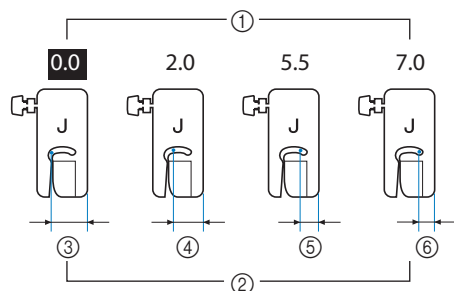

- ① Stitch width setting
- ② Distance from the needle position to the right side of the presser foot
- ③ 12.0 mm (1/2 inch)
- ④ 10.0 mm (3/8 inch)
- ⑤ 6.5 mm (1/4 inch)
- ⑥ 5.0 mm (3/16 inch)

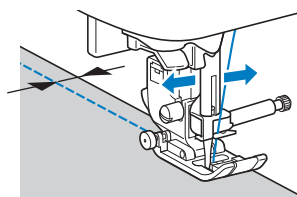

- For details, refer to “Setting the stitch width” in the “Basic operations” section.

# Blind Hem Stitching

Secure the bottoms of skirts and pants with a blind hem.

- Using the table below, refer to "Using the utility stitch tables in the "Sewing" section" in the "Basic operations" section.

Stitch name	Stitch	Model 4	Model 3, 2		Presser foot
			Model 3	Model 2	
Stitch number					
Blind hem stitch		2-01	36	31	R
Blind hem stretch stitch		2-02	37	32	



### Memo

- When the size of cylindrical pieces is too small to slide onto the arm or the length is too short, the fabric will not feed and desired results may not be achieved.

## 1 Turn the skirt or pants wrong side out.

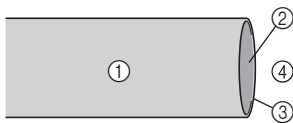

- ① Wrong side of fabric
- ② Right side of fabric
- ③ Edge of fabric
- ④ Bottom side

## 2 Fold the fabric along the desired edge of the hem, and press.

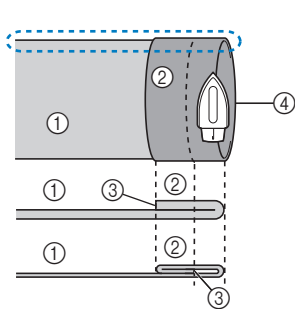

- ① Wrong side of fabric
- ② Right side of fabric
- ③ Edge of fabric
- ④ Desired edge of hem

<Thick fabric>

<Normal fabric>

<Seen from the side>

## 3 Use a chalk to mark on the fabric about 5 mm (3/16 inch) from the edge of the fabric, and then baste it.

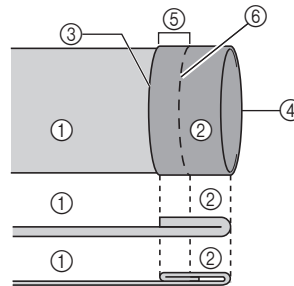

- ① Wrong side of fabric
- ② Right side of fabric
- ③ Edge of fabric
- ④ Desired edge of hem
- ⑤ 5 mm (3/16 inch)
- ⑥ Basting

<Thick fabric>

<Normal fabric>

<Seen from the side>

## 4 Fold back the fabric inside along the basting.

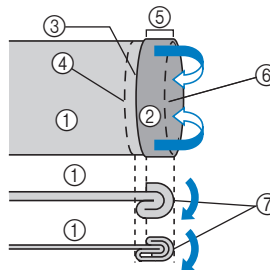

- ① Wrong side of fabric
- ② Right side of fabric
- ③ Edge of fabric
- ④ Desired edge of hem
- ⑤ 5 mm (3/16 inch)
- ⑥ Basting
- ⑦ Basting point

<Thick fabric>

<Normal fabric>

<Seen from the side>

## 5 Unfold the edge of fabric, and position the fabric with the wrong side facing up.

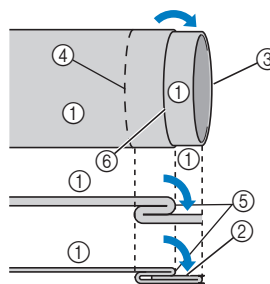

- ① Wrong side of fabric
- ② Right side of fabric
- ③ Edge of fabric
- ④ Desired edge of hem
- ⑤ Basting point
- ⑥ Basting

<Thick fabric>

<Normal fabric>

<Seen from the side>

## 6 Attach blind hem foot "R".

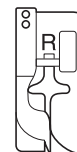

## 7 Select or .

## 8 Remove the flat bed attachment to use the free arm.

- 9 Slide the item that you wish to sew onto the free arm, make sure that the fabric feeds correctly, and then start sewing.

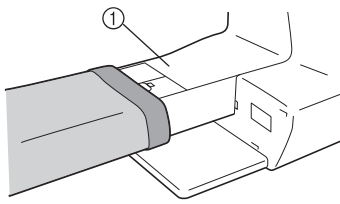

① Free arm

- 10 Position the fabric with the edge of the folded hem against the guide of the presser foot, and then lower the presser foot lever.

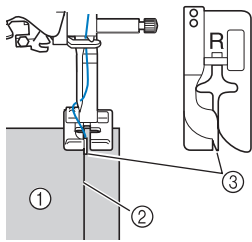

① Wrong side of fabric  
② Fold of hem  
③ Guide

- 11 Adjust the stitch width until the needle slightly catches the fold of the hem.

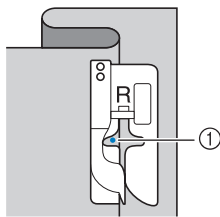

① Needle drop point  
When you change the needle drop point, raise the needle, and then change the stitch width.

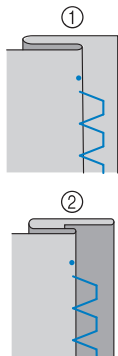
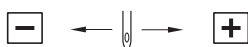

① Thick fabric  
② Normal fabric

### Memo

- Blind hem stitches cannot be sewn if the left needle drop point does not catch the fold. If the needle catches too much of the fold, the fabric cannot be unfolded and the seam appearing on the right side of the fabric will be very large, leaving an unattractive finish. If you experience either of these cases, perform the following instructions to solve the problem.

#### ■ If the needle catches too much of the hem fold

The needle is too far to the left.

Decrease the stitch width so that the needle slightly catches the fold of the hem.

- Example: Thick fabric

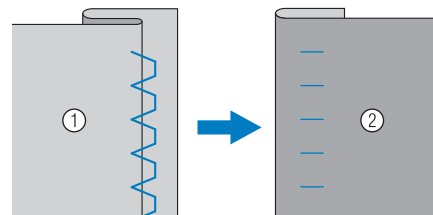

- Example: Normal fabric

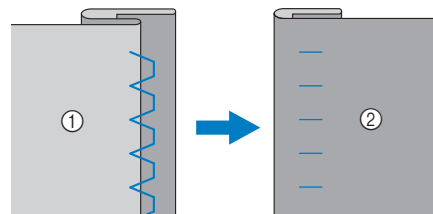

① Wrong side of fabric  
② Right side of fabric

#### ■ If the needle does not catch the hem fold

The needle is too far to the right.

Increase the stitch width so that the needle slightly catches the fold of the hem.

- Example: Thick fabric

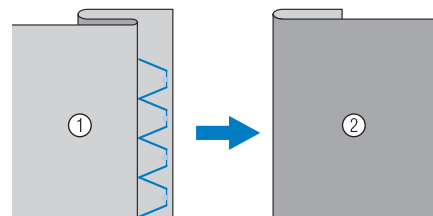

□ **Example:** Normal fabric

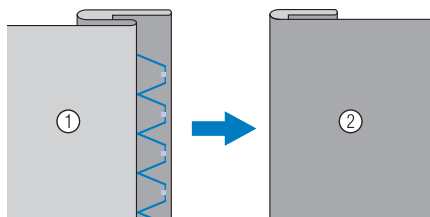

- ① Wrong side of fabric
- ② Right side of fabric

**12** Sew with the fold of the hem against the presser foot guide.

**13** Press the “Start/Stop” button to stop sewing when you are finished, and raise the presser foot and needle to remove the fabric by pulling it back.



**Note**

- Be sure to pull the fabric backward after finished sewing. If you pull the fabric toward side or forward, the presser foot may be damaged.

**14** Remove the basting stitching and reverse the fabric.

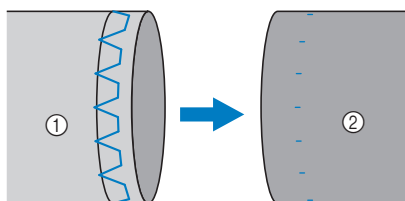



- ① Wrong side of fabric
- ② Right side of fabric

## Overcasting Stitches

Sew overcasting stitches along the edges of cut fabric to prevent them from fraying.

### Sewing overcasting stitches using overcasting foot "G"

- Using the table below, refer to "Using the utility stitch tables in the "Sewing" section" in the "Basic operations" section.

Stitch name	Stitch	Model 4	Model 3, 2		Presser foot
			Model 3, 2	Model 1	
Stitch number					
Overcasting stitch		1-15	15*	13*	G
		1-16	16	14	
		1-17	17	15	

\* Stitch patterns can be selected directly by pressing the numeric keys on the machine during preset utility stitch mode. Refer to "Basic operations" section.

#### 1 Attach overcasting foot "G".



#### 2 Select a stitch.

#### 3 Position the fabric with the edge of the fabric against the guide of the presser foot, and then lower the presser foot lever.

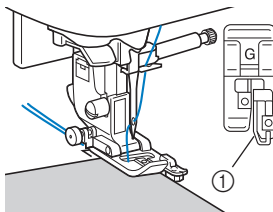

① Guide

#### 4 Sew with the edge of the fabric against the presser foot guide.

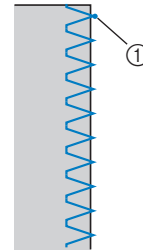

① Needle drop point

### ⚠ CAUTION

- After the stitch width is adjusted, rotate the handwheel toward you (counterclockwise). Check that the needle does not touch the presser foot. If the needle hits the presser foot, the needle may break and cause injury.

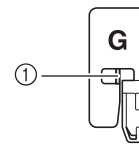

- ① The needle should not touch the center bar
- If the presser foot is raised to its highest level, the needle may strike the presser foot.

#### 5 Press the "Start/Stop" button to stop sewing when you are finished, and raise the presser foot and needle to remove the fabric by pulling it back.



## Sewing overcasting stitches using zigzag foot "J"

- Using the table below, refer to "Using the utility stitch tables in the "Sewing" section" in the "Basic operations" section.

Stitch name	Stitch	Model 4	Model 3, 2		Model 1	Presser foot
			Stitch number			
Zigzag stitch		1-09	09*	08*	J	
Zigzag stitch (Right)		1-11	11	10		
2 steps elastic zigzag stitch		1-13	13	11		
3 steps elastic zigzag stitch		1-14	14*	12*		
Overcasting stitch		1-18	18	16		
		1-19	19	17		
		1-20	20	18		
		1-21	21	19		
Single diamond overcast stitch		1-22	22	-		
		1-23	23	-		

\* Stitch patterns can be selected directly by pressing the numeric keys on the machine during preset utility stitch mode. Refer to "Basic operations" section.

- Attach zigzag foot "J".

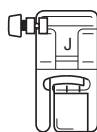

- Select a stitch.

- Sew along the edge of the fabric with the needle dropping off the edge at the right.

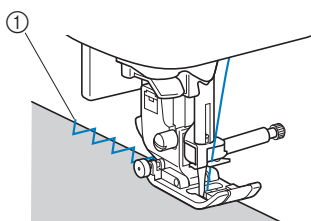

① Needle drop point

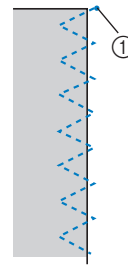

① Needle drop point

## Sewing overcasting stitches using the side cutter (sold separately with some models)

Using the side cutter, seam allowances can be finished while the edge of the fabric is cut off. Five utility stitches can be used to sew overcasting stitches with the side cutter.

- Using the table below, refer to "Using the utility stitch tables in the "Sewing" section" in the "Basic operations" section.



**Note**

- Thread the needle manually when using the side cutter, or only attach the side cutter after threading the needle using the needle threader.

Stitch name	Stitch	Model 4	Model 3, 2		Model 1	Presser foot
			Stitch number			
With side cutter		1-24	24	20	S	
		1-25	25	21		
		1-26	26	22		
		1-27	27	23		
		1-28	28	24		

Side cutter

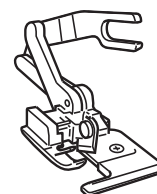

- 1 Remove the presser foot.
- 2 Hook the connecting fork of the side cutter onto the needle clamp screw.

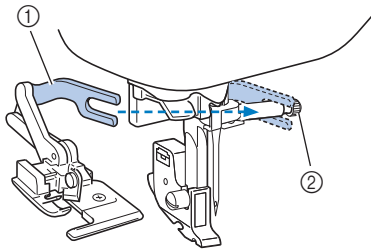

- ① Connecting fork
- ② Needle clamp screw

- 3 Position the side cutter so that side cutter pin is aligned with the notch in the presser foot holder, and then slowly lower the presser foot lever.

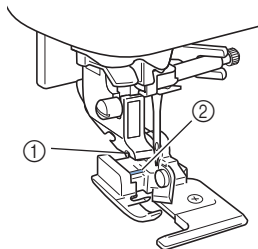

- ① Notch in presser foot holder
- ② Pin

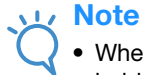
**Note**

- When it is hard to set under the presser foot holder, fit the pin on the side cutter into the notch of the presser foot holder raising up the presser foot lever higher.

- 4 Raise the presser foot lever to check that the side cutter is securely attached.
- 5 Pass the upper thread under the side cutter, and then pull it out toward the rear of the machine.

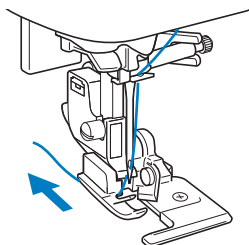

- 6 Select a stitch.
- 7 Make a cut of about 2 cm (3/4 inch) long in the fabric at the beginning of the stitching.

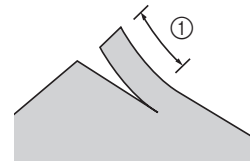

- ① 2 cm (3/4 inch)

- 8 Position the fabric in the side cutter. The cut in the fabric should be positioned over the guide plate of the side cutter.

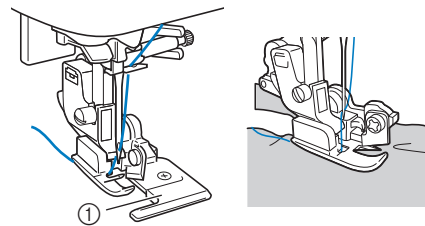

- ① Guide plate
- If the fabric is not positioned correctly, the fabric will not be cut.

- 9 Lower the presser foot lever, and then start sewing.

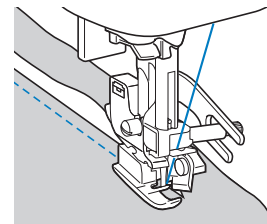

→ A seam allowance is cut while the stitching is sewn.

- If the stitching is sewn in a straight line  $\begin{matrix} \text{P} \\ | \\ \text{S} \end{matrix}$ , the seam allowance will be about 5 mm (3/16 inch).

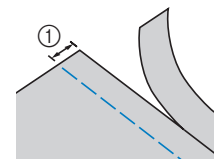













- ① 5 mm (3/16 inch)

**Memo**

- The side cutter can cut as much as one layer of 13-oz. denim.
- After using the side cutter, clean it by removing any lint or dust.
- If the side cutter can no longer cut fabric, use a piece of cloth to apply a small amount of oil to the cutting edge of the cutter.

## Buttonhole Stitching/Button Sewing

- Using the table below, refer to "Using the utility stitch tables in the "Sewing" section" in the "Basic operations" section.

Stitch name	Stitch	Model 4			Presser foot
			Model 3, 2	Model 1	
		Stitch number			
Narrow rounded buttonhole stitch		4-01	77	57	A
Tapered round ended buttonhole stitch		4-02	78	58	
Round ended buttonhole stitch		4-03	79	59	
Narrow squared buttonhole stitch		4-04	80	60	
Stretch buttonhole stitch		4-05	81	61	
Heirloom buttonhole stitch		4-06	82	62	
Bound buttonhole stitch		4-07	83	63	
Keyhole buttonhole stitch		4-08	84	64	
Tapered keyhole buttonhole stitch		4-09	85	65	
Keyhole buttonhole stitch		4-10	86	66	
Button sewing stitch		4-14	90	70	M

### Buttonhole sewing

The maximum buttonhole length is about 28 mm (1-1/8 inches) (diameter + thickness of the button).

Buttonholes are sewn from the front of the presser foot to the back, as shown below.

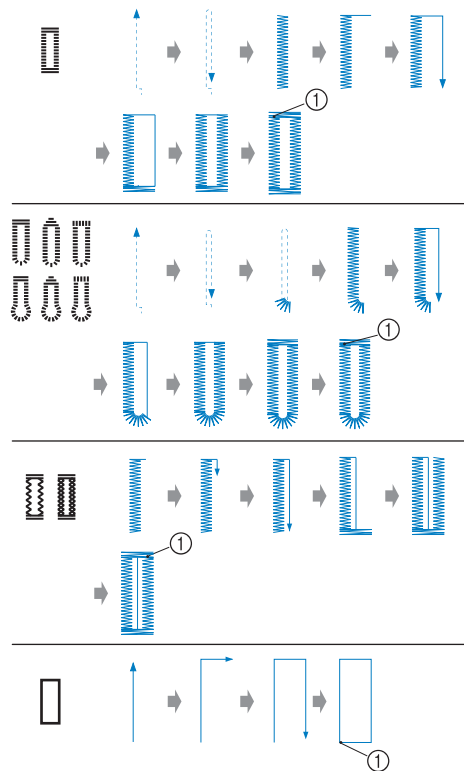

① Reinforcement stitching

The names of parts of buttonhole foot "A", which is used to create buttonholes, are indicated below.

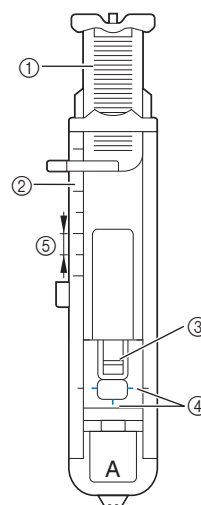

- ① Button guide plate
- ② Presser foot scale
- ③ Pin
- ④ Marks on buttonhole foot
- ⑤ 5 mm (3/16 inch)

**1** Use chalk to mark on the fabric the position and length of the buttonhole.

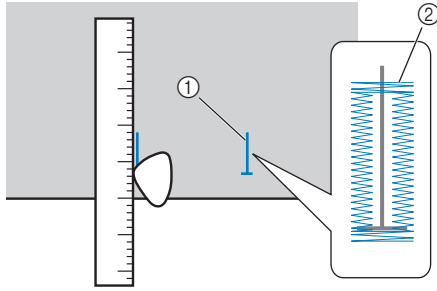

- ① Marks on fabric
- ② Buttonhole sewing

**2** Pull out the button guide plate of buttonhole foot "A", and then insert the button that will be put through the buttonhole.

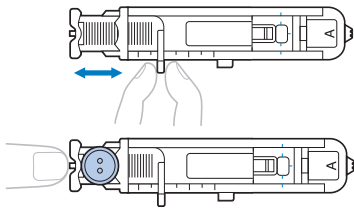

**■ If the button does not fit in the button guide plate**

Add together the diameter and thickness of the button, and then set the button guide plate to the calculated length. (The distance between the markings on the presser foot scale is 5 mm (3/16 inch).)

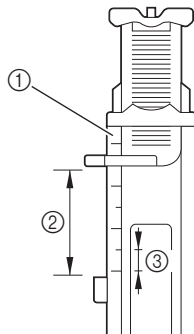

- ① Presser foot scale
- ② Length of buttonhole (diameter + thickness of button)
- ③ 5 mm (3/16 inch)

Example: For a button with a diameter of 15 mm (9/16 inch) and a thickness of 10 mm (3/8 inch), the button guide plate should be set to 25 mm (1 inch) on the scale.

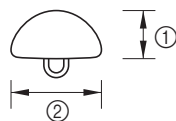

- ① 10 mm (3/8 inch)
- ② 15 mm (9/16 inch)

→ The size of the buttonhole is set.

**3** Attach buttonhole foot "A".

**4** Select a stitch.

**5** Position the fabric with the front end of the buttonhole mark aligned with the red marks on the sides of the buttonhole foot, and then lower the presser foot lever.

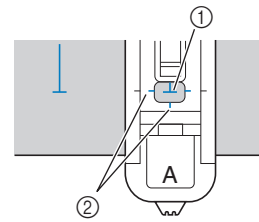

- ① Mark on fabric (front)
- ② Red marks on buttonhole foot

Pass the upper thread down through the hole in the presser foot.

- When lowering the presser foot, do not push in the front of the presser foot.

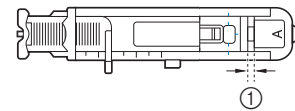
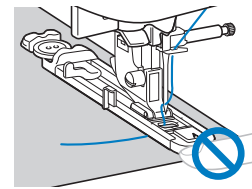

- ① Do not reduce the gap.

**6** Pull down the buttonhole lever as far as possible.

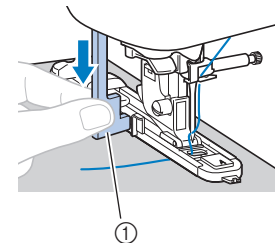

- ① Buttonhole lever
- The buttonhole lever is positioned behind the bracket on the buttonhole foot.

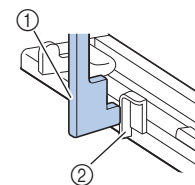

- ① Buttonhole lever
- ② Bracket

- 7** Gently hold the end of the upper thread in your left hand, and then start sewing.

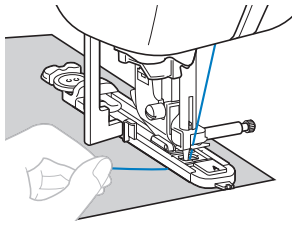

→ Once sewing is completed, the machine automatically sews reinforcement stitches, then stops.

- 8** Press  (Thread cutter button) once. Raise the presser foot, and then remove the fabric.

 **Memo**

- If the automatic thread cutting setting was selected before sewing, the machine will automatically cut the threads at the end of the stitching. For details, refer to “Automatically cutting the thread” in the “Basic operations” section.
- When using the thread cutter on the left side of the machine or scissors to cut the threads, press  (Needle position button) to raise the needle, raise the presser foot, and then pull out the fabric before cutting the threads.

- 9** Raise the buttonhole lever to its original position.

- 10** Insert a pin along the inside of one bar tack at the end of the buttonhole stitching to prevent the stitching from being cut.

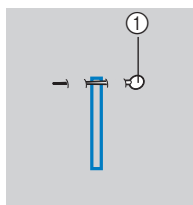

① Pin

- 11** Use the seam ripper to cut towards the pin and open the buttonhole.

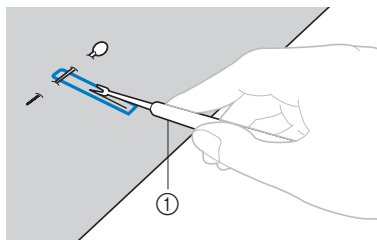

① Seam ripper

For keyhole buttonholes, use the eyelet punch to make a hole in the rounded end of the buttonhole, and then use the seam ripper to cut open the buttonhole.

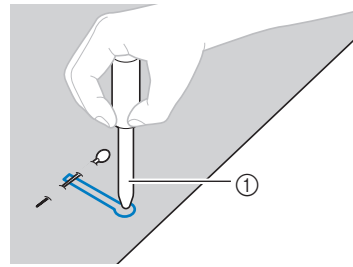

① Eyelet punch

- When using the eyelet punch, place thick paper or some other protective sheet under the fabric before punching the hole in the fabric.

**⚠ CAUTION**

- When opening the buttonhole with the seam ripper, do not place your hands in the cutting direction, otherwise injuries may result if the seam ripper slips.
- Do not use the seam ripper in any other way than how it is intended.

■ **Changing the density of the stitching**

Adjust the stitch length.

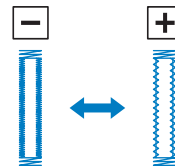

- For details, refer to “Setting the stitch length” in the “Basic operations” section.
- If the fabric does not feed (for example, if it is too thick), decrease the density of the stitching.

■ **Changing the stitch width**

Adjust the stitch width.

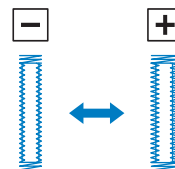

- For details, refer to “Setting the stitch width” in the “Basic operations” section.

 **Memo**

- Before sewing buttonholes, check the stitch length and width by sewing a trial buttonhole on a scrap piece of fabric.

■ **Sewing buttonholes on stretch fabrics**

When sewing buttonholes on stretch fabrics, use a gimp thread.

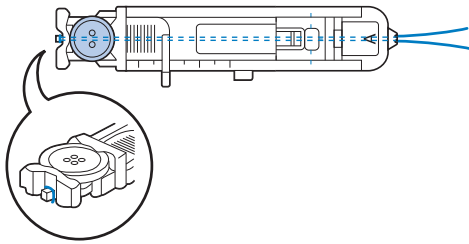

- 1 Hook the gimp thread onto the part of buttonhole foot "A" shown in the illustration.

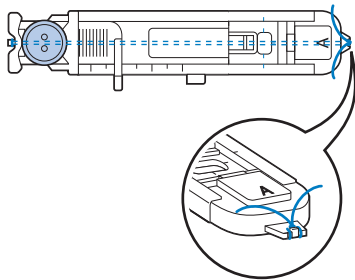

- 2 It fits into the grooves, and then loosely tie it.



- 3 Attach buttonhole foot "A".

- 4 Select stitch  or .

- 5 Adjust the stitch width to the thickness of the gimp thread.

- 6 Lower the presser foot lever and the buttonhole lever, and then start sewing.

- 7 When sewing is finished, gently pull the gimp thread to remove any slack.

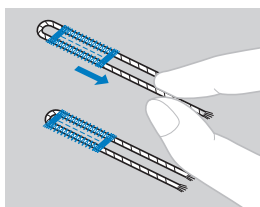



- 8 Use a handsewing needle to pull the gimp thread to the wrong side of the fabric, and then tie it.

## Button sewing

Buttons can be sewn on with the machine. Buttons with two or with four holes can be attached.

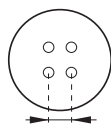
- 1 Measure the distance between the holes in the button to be attached.



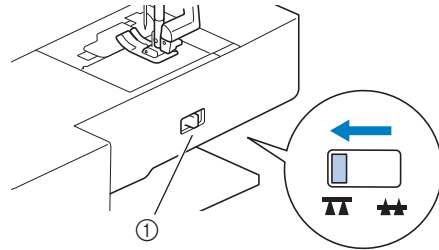

- 2 Raise the presser foot lever, and then slide the feed dog position switch, located at the rear of the machine on the base, to  (to the left as seen from the rear of the machine).

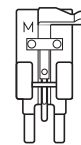

- 1 Feed dog position switch (as seen from the rear of the machine)

- 3 Attach button fitting foot "M".



- 4 Select stitch .

- Since the end of the thread will be tied off later, do not set the machine for programmed-thread cutting.

- 5 Adjust the stitch width so that it is the same as the distance between the holes in the button.

- 6 Place the button in the position where it will be sewn, and lower the presser foot lever.

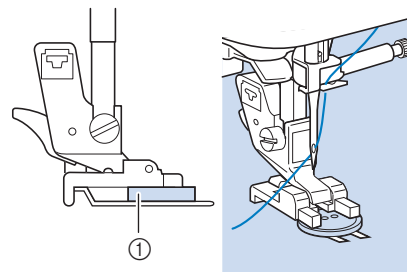

- 1 Button

- When attaching four-hole buttons, first sew the two holes closest to you. Then, slide the button so that the needle goes into the two holes toward the rear of the machine, and then sew them in the same way.

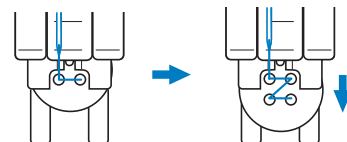

- 7 Turn the handwheel toward you (counterclockwise) to check that the needle correctly goes into the two holes of the button.**

If it seems as if the needle will hit the button, remeasure the distance between the holes in the button. Adjust the stitch width to the distance between the buttonholes.

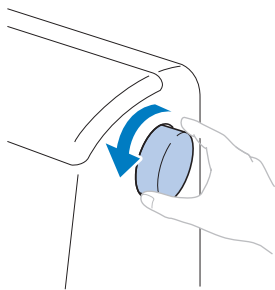

## ⚠ CAUTION

- When sewing, be sure that the needle does not touch the button, otherwise the needle may bend or break.

- 8 Start sewing.**

Set the sewing speed controller to the left (so that the speed will be slow).

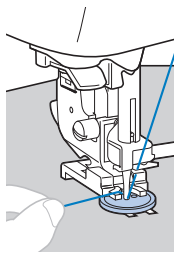



→ The machine automatically stops after sewing reinforcement stitches.

- Do not press  (Thread cutter button).

- 9 Use scissors to cut the upper thread and the bobbin thread at the beginning of the stitching.**

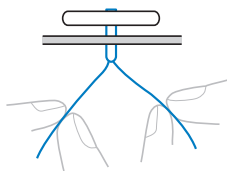
Pull the upper thread at the end of the stitching to the wrong side of the fabric, and then tie it with the bobbin thread.



- 10 When you are finished attaching the button, slide the feed dog position switch, to  (to the right as seen from the rear of the machine) and turn the handwheel to raise the feed dogs.**



### Memo

- The feed dogs come up when you start sewing again.

## ■ Attaching a shank to a button

To sew the button with a shank, attach the button with space between it and the fabric, and then wind the thread by hand. This attaches the button securely.

- 1 Place the button into button fitting foot “M”, and then pull the shank lever toward you.**

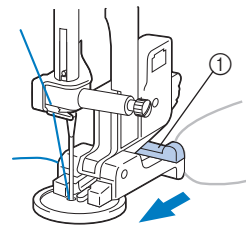

① Shank lever

- 2 After sewing is finished, cut the upper thread with plenty of excess, wind it around the thread between the button and the fabric, and then tie it to the upper thread at the beginning of the stitching.**

Tie together the ends of the bobbin thread at the end and at the beginning of the stitching at the wrong side of the fabric.



- 3 Cut off any excess thread.**

## Zipper Insertion

- Using the table below, refer to "Using the utility stitch tables in the "Sewing" section" in the "Basic operations" section.

Stitch name	Stitch	Model 4	Model 3, 2		Presser foot
		Stitch number			
Straight stitch (Middle)		1-03	03*	03*	J, I

\* Stitch patterns can be selected directly by pressing the numeric keys on the machine during preset utility stitch mode. Refer to "Basic operations" section.

### Inserting a centered zipper

Stitching is sewn on both pieces of fabric butted against each other.

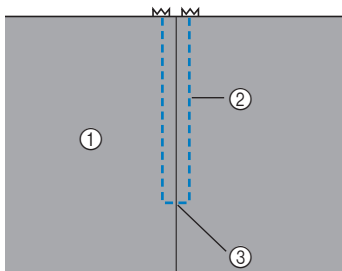

- ① Right side of fabric
- ② Stitching
- ③ End of zipper opening

- 1** Attach zigzag foot "J".
- 2** Sew straight stitches up to the zipper opening. With the right sides of the fabric facing each other, sew reverse stitches after reaching the zipper opening.
- 3** Using a basting stitch, continue sewing to the edge of the fabric.

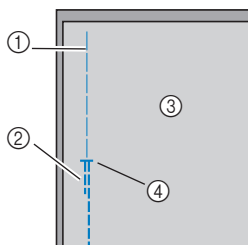

- ① Basting stitching
- ② Reverse stitches
- ③ Wrong side of fabric
- ④ End of zipper opening

- 4** Press open the seam allowance from the wrong side of the fabric.

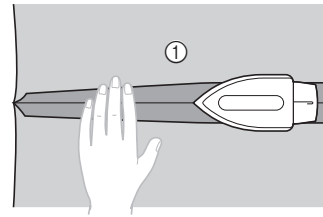

- ① Wrong side of fabric

- 5** Align the seam with the center of the zipper, and then baste the zipper in place.

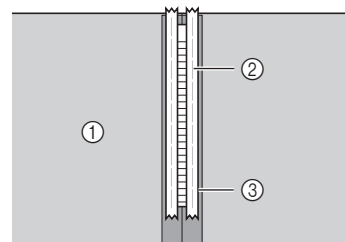

- ① Wrong side of fabric
- ② Basting stitching
- ③ Zipper

- 6** Remove about 5 cm (2 inches) from the end of the basting on the outside.

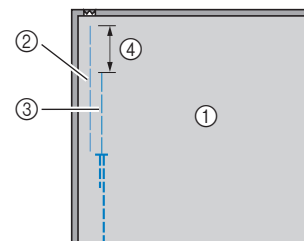

- ① Wrong side of fabric
- ② Zipper basting
- ③ Outside basting
- ④ 5 cm (2 inches)

- 7** Attach the presser foot holder to the right pin of zipper foot "I".

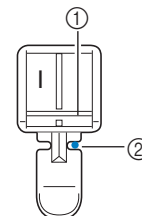

- ① Pin on the right side
- ② Needle drop point



**8** Select stitch 

**⚠ CAUTION**

- When using zipper foot “1”, be sure to select the straight stitch (center needle position), and slowly turn the handwheel toward you (counterclockwise) to check that the needle does not touch the presser foot. If a different stitch is selected or the needle hits the presser foot, the needle may bend or break.

**9** Topstitch around the zipper.

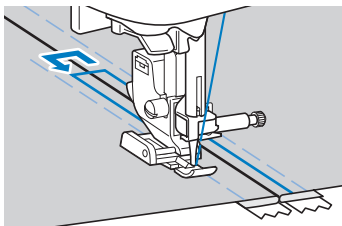
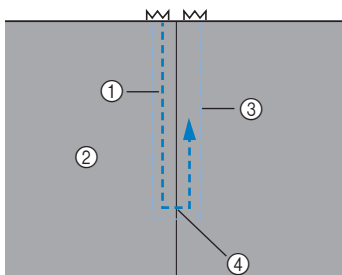

- ① Stitching
- ② Right side of fabric
- ③ Basting stitching
- ④ End of zipper opening

**⚠ CAUTION**

- When sewing, be sure that the needle does not touch the zipper, otherwise the needle may bend or break.

**10** Remove the basting stitching.

**Inserting a side zipper**

Stitching is visible on only one piece of fabric. Use this type of zipper application for side openings and back openings.

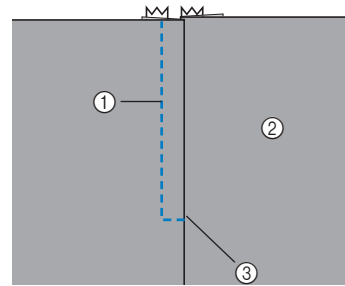

- ① Stitching
- ② Right side of fabric
- ③ End of zipper opening

The following procedure will describe how to stitch on the left side, as shown in the illustration.

**1** Attach zigzag foot “J”.

**2** Sew straight stitches up to the zipper opening.

With the right sides of the fabric facing each other, sew reverse stitches after reaching the zipper opening.

**3** Using a basting stitch, continue sewing to the edge of the fabric.

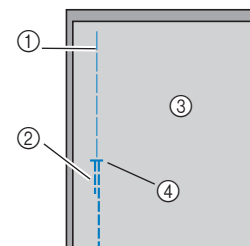

- ① Basting stitching
- ② Reverse stitches
- ③ Wrong side of fabric
- ④ End of zipper opening

**4** Press open the seam allowance from the wrong side of the fabric.

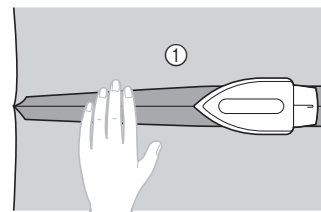

- ① Wrong side of fabric

- 5 Press the seam allowance so that the right side (the side that will not be stitched) has an extra 3 mm (1/8 inch).

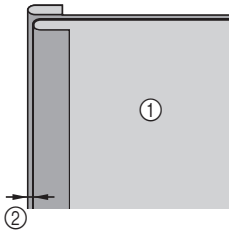

- ① Wrong side of fabric  
② 3 mm (1/8 inch)

- 6 Align the zipper teeth with the pressed edge of the fabric having the extra 3 mm (1/8 inch), and then baste or pin the zipper in place.

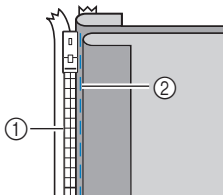

- ① Zipper teeth  
② Basting stitching

- 7 Attach the presser foot holder to the right pin of zipper foot "I".

If the stitching will be sewn on the right side, attach the presser foot holder to the left pin of the zipper foot.

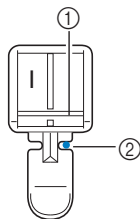

- ① Pin on the right side  
② Needle drop point

- 8 Select stitch .

## CAUTION

- When using zipper foot "I", be sure to select the straight stitch (center needle position), and slowly turn the handwheel toward you (counterclockwise) to check that the needle does not touch the presser foot. If a different stitch is selected or the needle hits the presser foot, the needle may bend or break.

- 9 Sew the zipper to the piece of fabric with the extra 3 mm (1/8 inch), starting from the base of the zipper.

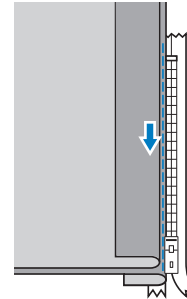

## CAUTION

- When sewing, be sure that the needle does not touch the zipper, otherwise the needle may bend or break.

- 10 When you are about 5 cm (2 inches) from the end of the zipper, stop the machine with the needle lowered (in the fabric), raise the presser foot lever.

- 11 Open the zipper and continue sewing.

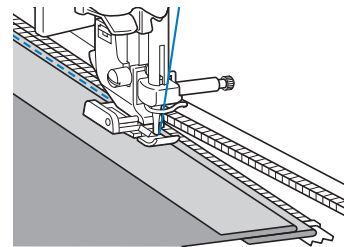

- 12 Close the zipper, turn over the fabric, and then baste the other side of the zipper to the fabric.

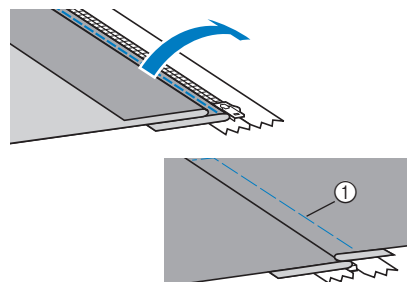

- ① Basting stitching

- 13 Attach the presser foot holder to the other pin of zipper foot "I".

If the presser foot holder was attached to the right pin in step 7, change it to the left pin.

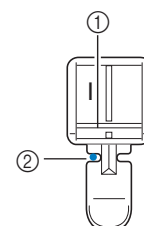

- ① Pin on the left side  
② Needle drop point

**14 Topstitch around the zipper.**

Sew reverse stitches at the end of the zipper opening and align the zipper teeth with the side of the presser foot.

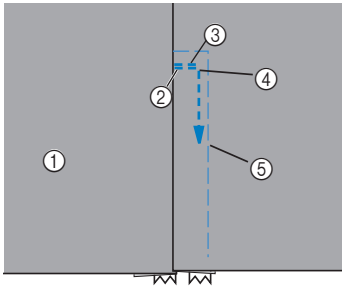

- ① Right side of fabric
- ② End of zipper opening
- ③ Reverse stitches
- ④ Beginning of stitching
- ⑤ Basting stitching

**! CAUTION**

- When sewing, be sure that the needle does not touch the zipper, otherwise the needle may bend or break.

**15** When you are about 5 cm (2 inches) from the end of the zipper, stop the machine with the needle lowered (in the fabric), and then raise the presser foot lever.

**16** Remove the basting stitching, open the zipper, and then continue sewing.

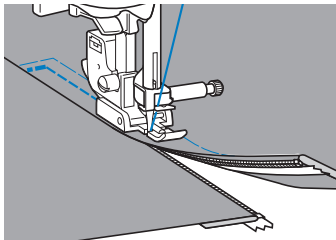

## Zipper/piping Insertion

A zipper and piping can be sewn in place.

- Using the table below, refer to "Using the utility stitch tables in the "Sewing" section" in the "Basic operations" section.

Stitch name	Stitch	Model 4	Model 3, 2		Presser foot
		Stitch number		Model 1	
Straight stitch (Left)		1-01	01*	01*	**

\* Stitch patterns can be selected directly by pressing the numeric keys on the machine during preset utility stitch mode. Refer to "Basic operations" section.

\*\*Adjustable zipper/piping foot (sold separately with some models)

### Inserting a centered zipper

- Refer to step 1–6 of "Inserting a centered zipper" on page S-19.
- Remove the presser foot and presser foot holder to attach the screw-on adjustable zipper/piping foot (sold separately with some models).
  - For details on removing the presser foot holder, refer to "Removing and attaching the presser foot holder" in the "Basic operations" section.

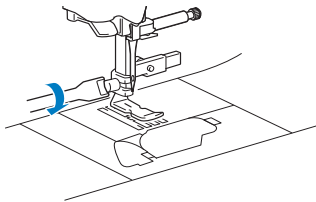

#### Note

- Make sure that the thread between the spool and the bobbin is pulled tight.

- Select stitch .
- Loosen the positioning screw on the back of the presser foot.

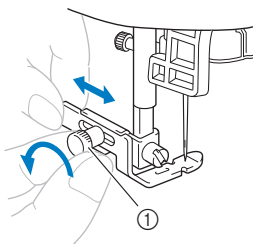

① Positioning screw

- Slide the presser foot over either the left or right feed dog.

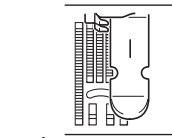
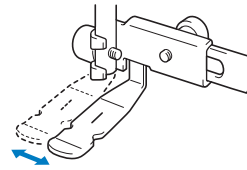

Left sewing position

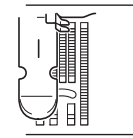

Right sewing position

- Change the needle position so that the needle does not touch the presser foot.

For details, refer to "Setting the stitch width" in the "Basic operations" section.



① Needle drop point

### CAUTION

- After adjusting the needle position, slowly turn the handwheel toward you (counterclockwise) and check the needle does not touch the presser foot. If the needle hits the presser foot, the needle may bend or break.

- Securely tighten the positioning screw.

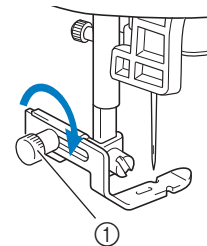

① Positioning screw

**8** Topstitch around the zipper.

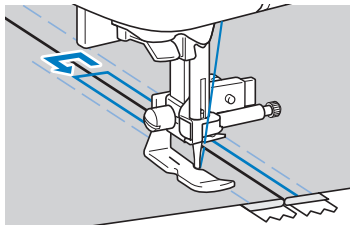
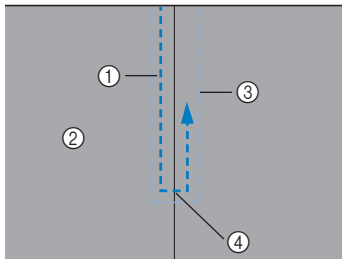

- ① Stitching
- ② Right side of fabric
- ③ Basting stitching
- ④ End of zipper opening

**4** After sewing, turn them over.

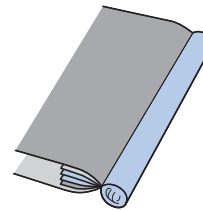

**⚠ CAUTION**

- When sewing, be sure that the needle does not touch the zipper, otherwise the needle may bend or break.

**9** Remove the basting stitching.

**Inserting a piping**

**1** Place the piping between two fabrics inside out, as shown below.

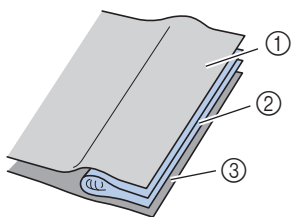

- ① Fabric
- ② Piping
- ③ Fabric



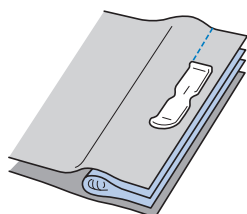

**2** Refer to the steps of attaching the adjustable zipper/piping foot on the previous page.

**3** Sew along the piping.



# Sewing Stretch Fabrics and Elastic Tape

- Using the table below, refer to "Using the utility stitch tables in the "Sewing" section" in the "Basic operations" section.

Stitch name	Stitch	Model 4	Model 3, 2		Presser foot
			Model 3, 2	Model 1	
Stitch number					
Stem stitch		1-06	06*	06*	J
2 steps elastic zigzag stitch		1-13	13	11	
3 steps elastic zigzag stitch		1-14	14*	12*	
Tape attaching stitch		2-13	48	42	

\* Stitch patterns can be selected directly by pressing the numeric keys on the machine during preset utility stitch mode. Refer to "Basic operations" section.

## Stretch stitching

- Attach zigzag foot "J".

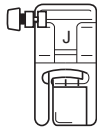

- Select stitch .

- Sew the fabric without stretching it.

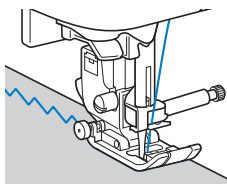

## Elastic attaching

When elastic tape is attached to the cuff or waist of a piece of clothing, the finished dimensions will be that of the stretched elastic tape. Therefore, it is necessary that a suitable length of the elastic tape be used.

- Pin the elastic tape to the wrong side of the fabric.  
Pin the elastic tape to the fabric at a few points to make sure that the tape is uniformly positioned on the fabric.

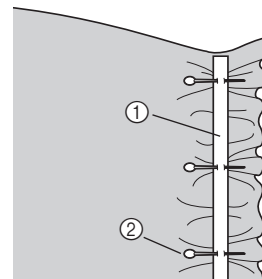

- ① Elastic tape
- ② Pin

- Attach zigzag foot "J".

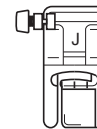

- Select a stitch.

- Sew the elastic tape to the fabric while stretching the tape so that it is the same length as the fabric.

While pulling the fabric behind the presser foot with your left hand, pull the fabric at the pin nearest the front of the presser foot with your right hand.

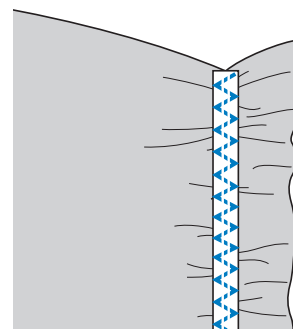
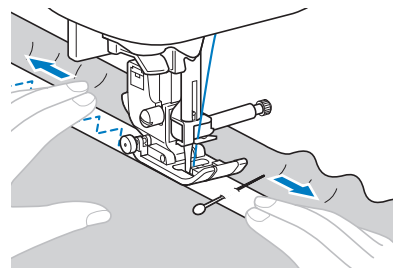













**⚠ CAUTION**

- When sewing, be sure that the needle does not touch any pins, otherwise the needle may bend or break.

UTILITY STITCHES

## Appliqué, Patchwork and Quilt Stitching

- Using the table below, refer to "Using the utility stitch tables in the "Sewing" section" in the "Basic operations" section.

Stitch name	Stitch	Model 4			Presser foot
			Model 3, 2	Model 1	
		Stitch number			
Zigzag stitch		1-09	09*	08*	J
Quilting appliqué zigzag stitch		1-33	33	28	
Blanket stitch		2-03	38	33	
Quilting appliqué stitch		1-34	34	29	
Piecing stitch (Right)		1-29	29	25	
Piecing stitch (Middle)		1-30	30	26	
Piecing stitch (Left)		1-31	31	-	
Patchwork join stitch		2-07	42	36	
Patchwork double overlock stitch		2-08	43	37	
Couching stitch		2-09	44	38	
Hand-look quilting stitch		1-32	32	27	
Quilting stippling stitch		1-35	35	30	

\* Stitch patterns can be selected directly by pressing the numeric keys on the machine during preset utility stitch mode. Refer to "Basic operations" section.



### Memo

- Patterns showing a "Q" in the table above are for quilting and those showing a "P" are for piecing.

## Appliqué stitching

- Cut out the appliqué, leaving a seam allowance of between 3 and 5 mm (1/8 and 3/16 inch).

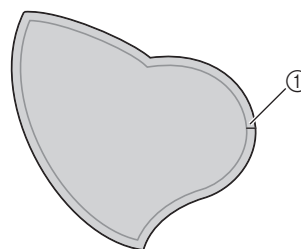

① Seam allowance

- Place a pattern made of thick paper or stabilizer on the back of the appliqué, and then fold over the seam allowance using an iron.

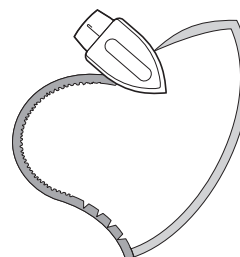

- Turn the fabric over, and then baste or fuse it onto the fabric that it will be attached to.

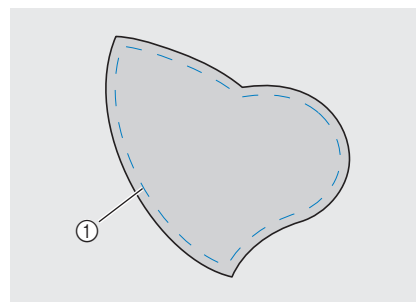

① Basting stitching

- Attach the zigzag foot "J" or the open toe foot (sold separately with some models) shown below.

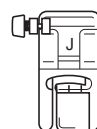

Zigzag foot "J"

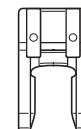

Open toe foot

- Select a stitch.

- Turn the handwheel toward you (counterclockwise), and then begin sewing around the edge of the appliqué, making sure that the needle drops just outside of the appliqué.

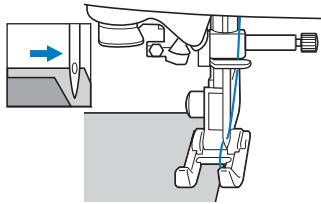

When sewing around corners, stop the machine with the needle in the fabric just outside of the appliqué, raise the presser foot lever, and then turn the fabric as needed to change the sewing direction.

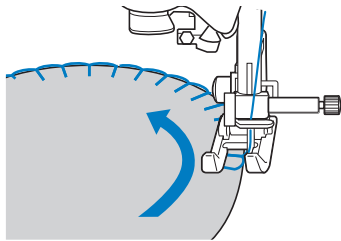

### Patchwork (crazy quilt) stitching

- Fold the edge of the top piece of fabric and place it over the lower piece.
- Sew the two pieces of fabric together so the pattern spans over both pieces.

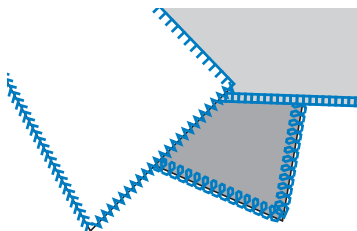
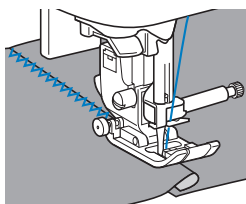



### Piecing

Sewing together two pieces of fabric is called “piecing”. The fabric pieces should be cut with a 6.5 mm (1/4 inch) seam allowance.

Sew a piecing straight stitch 6.5 mm (1/4 inch) from either the right side or the left side of the presser foot.

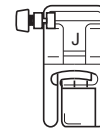
- Baste or pin along the seam allowance of the fabric that you wish to piece together.
- Attach zigzag foot “J”.



- Select stitch .
- Sew with the side of the presser foot aligned with the edge of the fabric.

#### ■ For a seam allowance on the right side

Align the right side of the presser foot with the edge of the fabric, and sew using stitch .

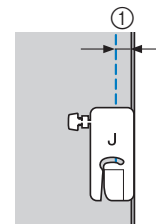

① 6.5 mm (1/4 inch)

#### ■ For a seam allowance on the left side

Align the left side of the presser foot with the edge of the fabric, and sew using stitch .

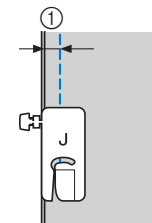

① 6.5 mm (1/4 inch)

#### 📖 Memo

- To change the width of the seam allowance (needle position), adjust the stitch width. For details, refer to “Setting the stitch width” in the “Basic operations” section.



### ■ Piecing using the 1/4" quilting foot with guide (sold separately with some models)

This quilting foot can sew an accurate 1/4 inch or 1/8 inch seam allowance.

It can be used for piecing together a quilt or for topstitching.

- 1 Press , and then attach the 1/4" quilting foot with guide.

- 2 Use the guide and marks on the presser foot to sew accurate seam allowances.

#### Piecing a 1/4 inch seam allowance

Sew keeping the edge of the fabrics against the guide.

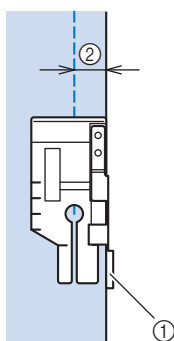

- ① Guide
- ② 1/4 inch

#### Creating an accurate seam allowance

Use the mark on the foot to begin, end, or pivot 1/4 inch from edge of fabric.

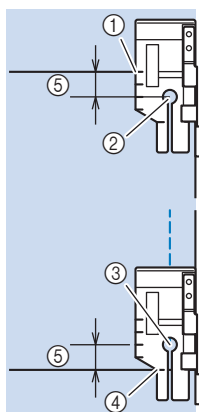

- ① Align this mark with edge of fabric to begin.
- ② Beginning of stitching
- ③ End of stitching
- ④ Opposite edge of fabric to end or pivot
- ⑤ 1/4 inch



#### Memo

- For details, refer to "Pivoting" in the "Basic operations" section.

### Topstitching quilting, 1/8 inch

Sew with the edge of the fabric aligned with the left side of the presser foot end.

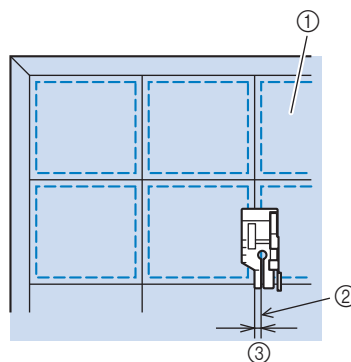



- ① Surface of fabric
- ② Seam
- ③ 1/8 inch

### ■ Using the 1/4" quilting foot (sold separately with some models)

If the 1/4" quilting foot is used, seams can be sewn with a seam allowance of 6.4 mm (1/4 inch).

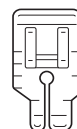
- 1 Baste or pin along the seam allowance of the fabric that you wish to piece together.
- 2 Attach the 1/4" quilting foot.



- 3 Select stitch .

- 4 Align the mark at the upper edge of the 1/4" quilting foot with the upper edge of the fabric.

Align the right edge of the fabric with the right edge of the narrow part of the 1/4" quilting foot.

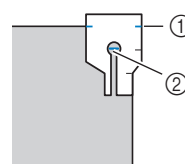

- ① Mark on 1/4" quilting foot
- ② Beginning of stitching

When sewing with a seam allowance, align the left edge of the narrow part of the 1/4" quilting foot with the fabric edge.

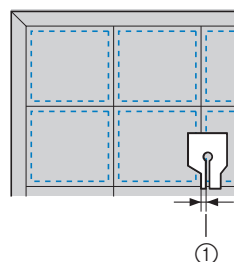

- ① Seam (3.2 mm (1/8 inch))

**5 Start sewing.**

**6 When the end of the stitching is reached, stop the machine.**

Sew until the mark at the lower edge of the 1/4" quilting foot aligns with the lower edge of the fabric.

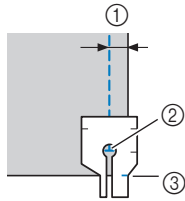

- ① 6.4mm (1/4 inch)
- ② End of stitching
- ③ Mark on 1/4" quilting foot

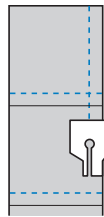

## Quilting

Sandwiching batting between the top and bottom layers of fabric is called "quilting". Quilts can easily be sewn using the walking foot\* and the quilting guide\*.

\* Sold separately with some models.

### Note

- Thread the needle manually when using the walking foot, or only attach the walking foot after threading the needle using the needle threader.
- When sewing with the walking foot, sew at a speed between slow and medium.
- When quilting, use a 90/14 home machine needle.
- The walking foot can only be used with straight or zigzag stitch patterns. Reverse stitches cannot be sewn with the walking foot. Only select straight or zigzag stitch patterns with reinforcement stitches. For details, refer to "Stitch Setting Chart" in the "Basic operations" section.
- (For models equipped with Automatic Fabric Sensor System)  
When "Automatic Fabric Sensor System" in the settings screen is set to "ON", the thickness of the fabric is automatically detected by the internal sensor so the fabric can be fed smoothly for best sewing results. For details on the automatic fabric sensor system, refer to "Automatic Fabric Sensor System (Automatic presser foot pressure)" in the "Basic operations" section.

**1 Baste the fabric to be quilted.**

**2 Remove the presser foot and the presser foot holder.**

- For details, refer to "Removing and attaching the presser foot holder" in the "Basic operations" section.

**3 Hook the connecting fork of the walking foot onto the needle clamp screw.**

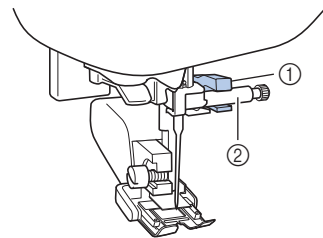

- ① Connecting fork
- ② Needle clamp screw

**4 Lower the presser foot lever, insert the presser foot holder screw, and then tighten the screw with the screwdriver.**

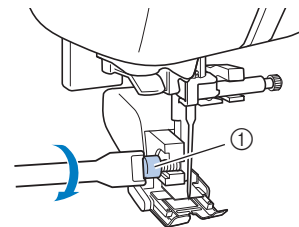

- ① Presser foot holder screw

## CAUTION

- Be sure to securely tighten the screws with the screwdriver, otherwise the needle may touch the presser foot, causing it to bend or break.
- Before starting to sew, slowly turn the handwheel toward you (counterclockwise) and check that the needle does not touch the presser foot. If the needle hits the presser foot, the needle may bend or break.

**5 Select a stitch.**

**6 Place one hand on each side of the presser foot, and then evenly guide the fabric while sewing.**

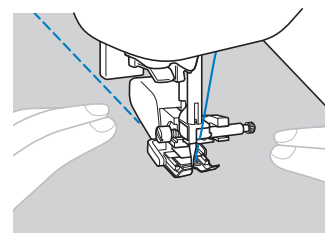

■ **Using the quilting guide (sold separately with some models)**

Use the quilting guide to sew parallel stitches that are equally spaced.

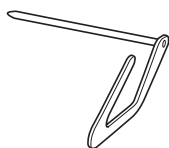

1 Insert the stem of the quilting guide into the hole at the rear of the walking foot or presser foot holder.

□ Walking foot

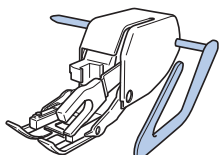

□ Presser foot holder

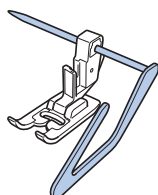

2 Adjust the stem of the quilting guide so that the guide aligns with the seam that has already been sewn.

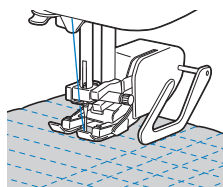

**Free motion quilting**

We recommend attaching the foot controller and sewing at a consistent speed. You can adjust the sewing speed with the speed control slide on the machine.

**CAUTION**

- With free motion quilting, control the feeding speed of the fabric to match the sewing speed. If the fabric is moved faster than the sewing speed, the needle may break or other damage may result.



**Memo**

- On models equipped with the free motion sewing mode, the presser foot can be adjusted to the best height for free motion sewing. For details, refer to “Sewing with free motion mode” in the “Basic operations” section.

■ **Using free motion open toe quilting foot “O”\* or quilting foot\***

\* Sold separately with some models.

The free motion open toe quilting foot “O” or quilting foot is used for free motion quilting with zigzag or decorative stitches or for free motion quilting of straight lines on fabric with an uneven thickness. Various stitches can be sewn using free motion open toe quilting foot “O”. For details on the stitches that can be used, refer to “Stitch Setting Chart” in the “Basic operations” section.

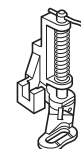
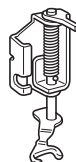

□ Free motion open toe quilting foot “O”

□ Quilting foot

1 Slide the feed dog position switch, located at the rear of the machine on the base, to (to the left as seen from the rear of the machine).

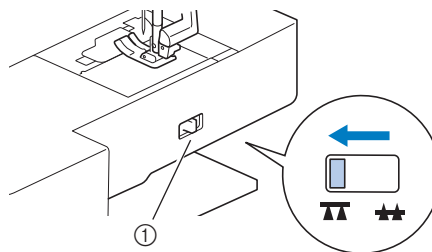

① Feed dog position switch (as seen from the rear of the machine)  
→ The feed dogs are lowered.

2 Select a stitch.

3 Remove the presser foot holder.

- For details, refer to “Removing and attaching the presser foot holder” in the “Basic operations” section.

4 Attach free motion open toe quilting foot “O” by positioning the pin of the quilting foot above the needle clamp screw and aligning the lower-left of the quilting foot and the presser bar.

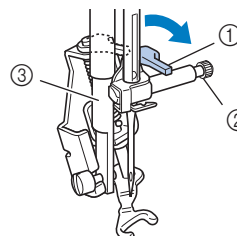

- ① Pin
- ② Needle clamp screw
- ③ Presser bar



**Note**

- Make sure that the quilting foot is not slanted.

- 5 Hold the quilting foot in place with your right hand, and tighten the presser foot holder screw using the screwdriver with your left hand.

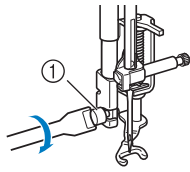

① Presser foot holder screw

## ⚠ CAUTION

- Be sure to securely tighten the screws with the included screwdriver. Otherwise, the needle may touch the quilting foot, causing it to bend or break.

- 6 Use both hands to stretch the fabric taut, and then move the fabric at a consistent pace in order to sew uniform stitches roughly 2.0 mm - 2.5 mm (approx. 1/16 inch - 3/32 inch) in length.

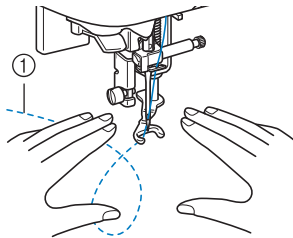

① Stitch

- 7 After sewing is finished, slide the feed dog position switch lever to **▲▲** (to the right as seen from the rear of the machine) and turn the handwheel to raise the feed dogs.

### 📖 Memo

- Do not be discouraged with your initial results. The technique requires practice.

### ■ Using free motion quilting foot “C” (sold separately with some models)

Use the free motion quilting foot “C” with straight stitch needle plate for free motion sewing.

- Free motion quilting foot “C”



## ⚠ CAUTION

- When using free motion quilting foot “C”, be sure to use the straight stitch needle plate and sew with the needle in middle (center) needle position. If the needle is moved to any position other than the middle (center) needle position, the needle may break, which may result in injuries.

### 📖 Memo

- On models equipped with the free motion sewing mode, the presser foot can be adjusted to the best height for free motion sewing. For details, refer to “Sewing with free motion mode” in the “Basic operations” section.

- 1 Attach the straight stitch needle plate (sold separately with some models).

- For details on attaching the straight stitch needle plate, refer to operation manual supplied with the product.

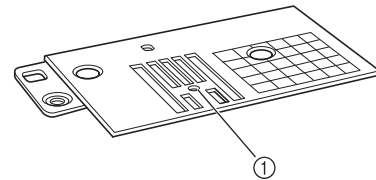

① Round hole

### 📖 Memo

- Notice this needle plate has a round hole for the needle.

- 2 Slide the feed dog position switch, located at the rear of the machine on the base, to **▲▲** (to the left as seen from the rear of the machine).

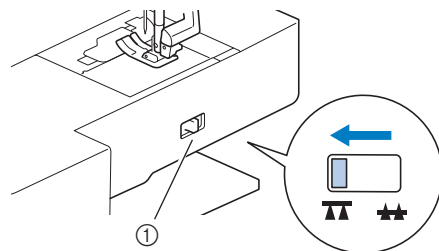

① Feed dog position switch (as seen from the rear of the machine)

→ The feed dogs are lowered.

- 3 Select **i.p.**

- 4 Remove the presser foot holder.

- For details, refer to “Removing and attaching the presser foot holder” in the “Basic operations” section.

- 5** Attach free motion quilting foot “C” at the front with the presser foot holder screw aligned with the notch in the quilting foot.

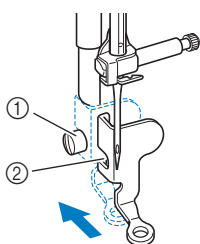

- ① Presser foot holder screw
- ② Notch



**Note**

- Make sure that the quilting foot is attached properly and not slanted.

- 6** Hold the quilting foot in place with your right hand, and tighten the presser foot holder screw using the screwdriver with your left hand.

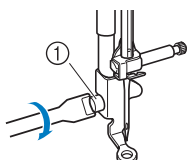

- ① Presser foot holder screw

**⚠ CAUTION**

- Be sure to securely tighten the screws with the included screwdriver. Otherwise, the needle may touch the quilting foot, causing it to bend or break.

- 7** Use both hands to stretch the fabric taut, and then move the fabric at a consistent pace in order to sew uniform stitches roughly 2.0 mm - 2.5 mm (approx. 1/16 inch - 3/32 inch) in length.

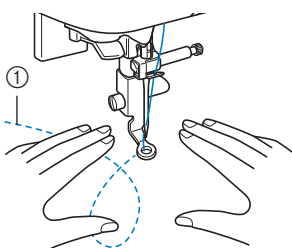

- ① Stitch

- 8** After sewing is finished, slide the feed dog position switch lever to **▲▲** (to the right as seen from the rear of the machine) and turn the handwheel to raise the feed dogs.



**Note**

- Free motion open toe quilting foot “O” can also be used with the straight stitch needle plate. We recommend using free motion open toe quilting foot “O” with free motion sewing of fabrics of uneven thicknesses.
- When using the straight stitch needle plate, all straight stitches become middle needle position stitches. You cannot change the needle position using the width display.



**Memo**

- Do not be discouraged with your initial results. The technique requires practice.

**■ Echo quilting using the free motion echo quilting foot “E” (sold separately with some models)**

Sewing quilting lines at equal distances around a motif is called echo quilting. The quilting lines, which appear as ripples echoing away from the motif, are the distinguishing characteristic of this quilting style. Use the optional free motion echo quilting foot “E” for echo quilting. Using the measurement on the presser foot as a guide, sew around the motif at a fixed interval. We recommend attaching the foot controller and sewing at a consistent speed.

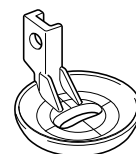

Free motion echo quilting foot “E” measurement

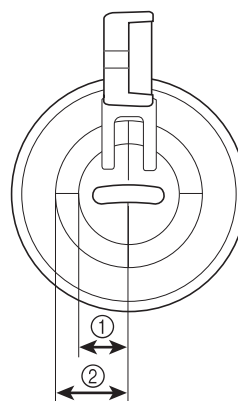

- ① 6.4 mm (approx. 1/4 inch)
- ② 9.5 mm (approx. 3/8 inch)

## ⚠ CAUTION

- With free motion quilting, control the feeding speed of the fabric to match the sewing speed. If the fabric is moved faster than the sewing speed, the needle may break or other damage may result.

### 📖 Memo

- On models equipped with the free motion sewing mode, the presser foot can be adjusted to the best height for free motion sewing. For details, refer to “Sewing with free motion mode” in the “Basic operations” section.

- 1 Slide the feed dog position switch, located at the rear of the machine on the base, to  (to the left as seen from the rear of the machine).

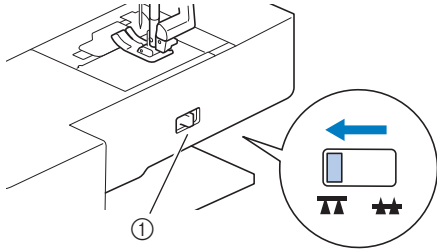

① Feed dog position switch (as seen from the rear of the machine)

→ The feed dogs are lowered.

- 2 Select .

- 3 Remove the presser foot holder (see the “Basic operations” section) and the screw.

- 4 Position the free motion echo quilting foot “E” on the left side of the presser bar with the holes in the quilting foot and presser bar aligned.

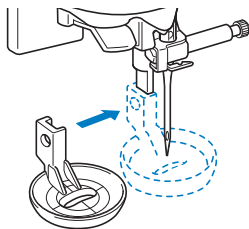

- 5 Tighten the screw with the included screwdriver.

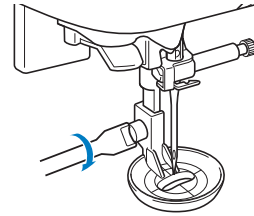
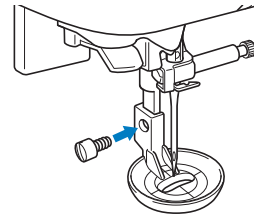

## ⚠ CAUTION

- Be sure to securely tighten the screws with the included screwdriver. Otherwise, the needle may touch the quilting foot, causing it to bend or break.

- 6 Using the measurement on the quilting foot as a guide, sew around the motif.

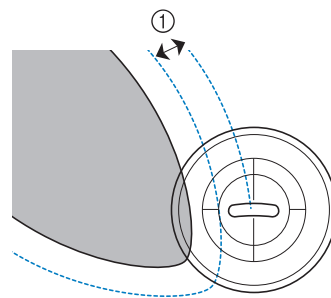
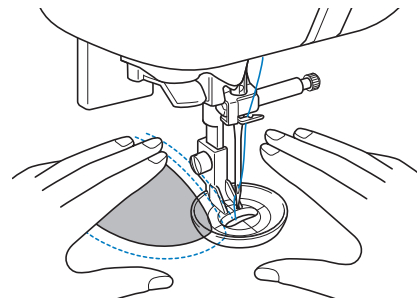

① 6.4 mm (approx. 1/4 inch)

Finished project

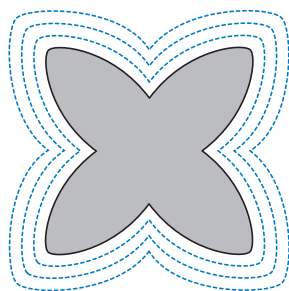

- After sewing is finished, slide the feed dog position switch lever to (to the right as seen from the rear of the machine) and turn the handwheel to raise the feed dogs.

### Satin stitching using the sewing speed controller

A decorative stitch can be sewn by changing the stitch width of a satin stitch. If the machine is set so that the stitch width can be adjusted using the sewing speed controller, the stitch width can quickly and easily be adjusted. In this case, the sewing speed is adjusted with the foot controller.

- Connect the foot controller.
- Attach zigzag foot “J”.

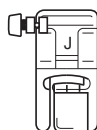

- Press to display the settings screen, and set “Width Control” to “ON”.

The settings screens differ depending on the models.

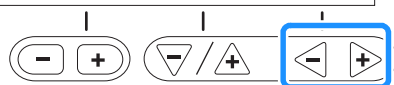
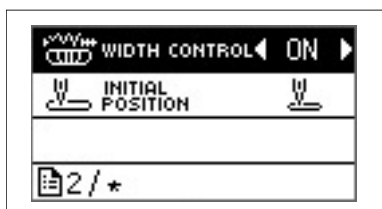
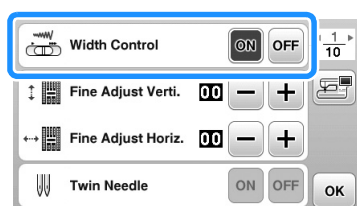

→ The machine is now set so that the stitch width can be controlled with the sewing speed controller.

- Press .

- Select stitch .

- While sewing, slide the sewing speed controller to adjust the stitch width.

Slide the controller to the left to make the width narrower. Slide the controller to the right to make the width wider.

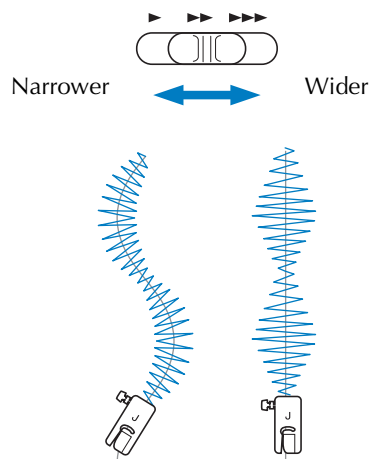

- Adjust the sewing speed with the foot controller.

- When you are finished sewing, set the stitch width control setting back to “OFF”.





### Memo

- Although the stitching result differs depending on the type of fabric being sewn and the thickness of the thread being used, for best results, adjust the stitch length to between 0.3 and 0.5 mm (1/64 and 1/32 inch).

## Reinforcement Stitching

Reinforce points that will be subject to strain, such as sleeve holes, inseams and pocket corners.

- Using the table below, refer to "Using the utility stitch tables in the "Sewing" section" in the "Basic operations" section.

Stitch name	Stitch	Model 4	Model 3, 2		Presser foot
			Model 3, 2	Model 1	
Stitch number					
Triple stretch stitch		1-05	05*	05*	J
Bar tack stitch		4-13	89	69	A
Darning stitch		4-11	87	67	
		4-12	88	68	

\* Stitch patterns can be selected directly by pressing the numeric keys on the machine during preset utility stitch mode. Refer to "Basic operations" section.

### Triple stretch stitching

Use triple stretch stitching to reinforce sleeve holes and inseams.

- Attach zigzag foot "J".

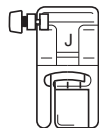

- Select stitch .

- Start sewing.

### Bar tack stitching

Bar tacks are used to reinforce points subject to strain, such as pocket corners and openings.

As an example, the procedure for sewing bar tacks at pocket corners is described below.

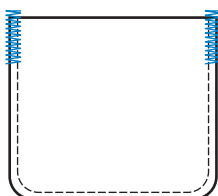

- Determine the desired length of the bar tack.

Set the button guide plate on buttonhole foot "A" to the desired length. (The distance between the markings on the presser foot scale is 5 mm (3/16 inch).)

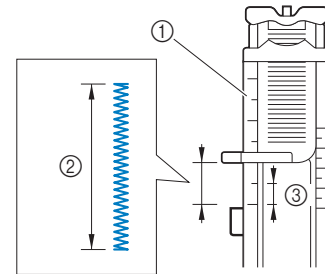

- Presser foot scale
- Length of bar tack
- 5 mm (3/16 inch)

- A bar tack with a maximum length of about 28 mm (1-1/8 inches) can be sewn.

- Attach buttonhole foot "A".

- Select stitch .

- Position the fabric so that the opening of the pocket faces toward you, and then lower the presser foot lever so that the needle drops 2 mm (1/16 inch) in front of the pocket opening.

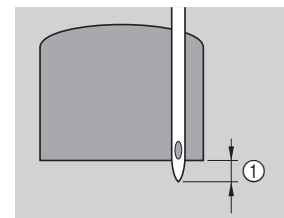

- 2 mm (1/16 inch)

Pass the upper thread down through the hole in the presser foot.

- When lowering the presser foot, do not push in the front of the presser foot, otherwise the bar tack will not be sewn with the correct size.

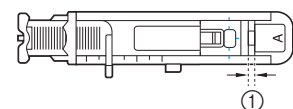
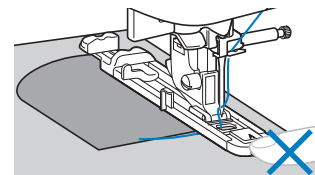

- Do not reduce the gap.



- 5 Pull down the buttonhole lever as far as possible.**

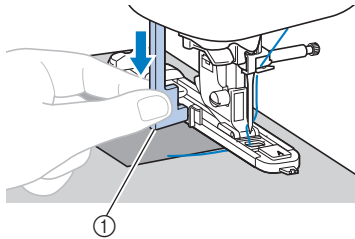

- ① Buttonhole lever  
The buttonhole lever is positioned behind the bracket on the buttonhole foot.

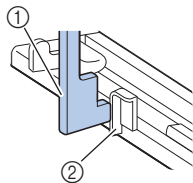

- ① Buttonhole lever  
② Bracket

- 6 Gently hold the end of the upper thread in your left hand, and then start sewing.**

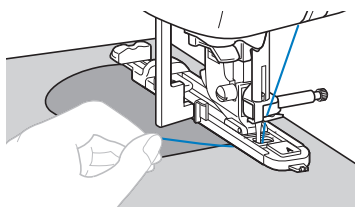

- 7 Raise the presser foot lever, remove the fabric, and then cut the threads.**

- 8 Raise the buttonhole lever to its original position.**

**Memo**

- If the fabric does not feed, for example, because it is too thick, increase the stitch length. For details, refer to “Setting the stitch length” in the “Basic operations” section.

**Darning**

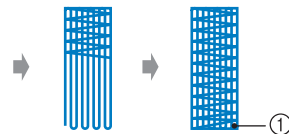
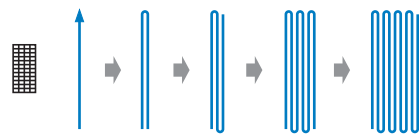
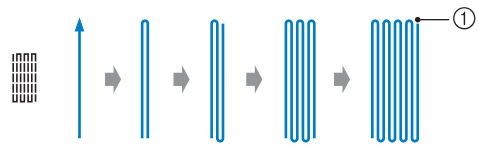

- ① Reinforcement stitching

- 1 Determine the desired length of the darning.**

Set the button guide plate on buttonhole foot “A” to the desired length. (The distance between the markings on the presser foot scale is 5 mm (3/16 inch).)

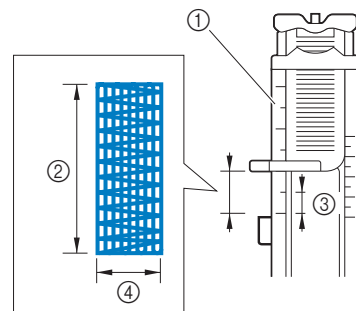

- ① Presser foot scale  
② Length of darning  
③ 5 mm (3/16 inch)  
④ 7 mm (1/4 inch)

- A bar tack with a maximum length of about 28 mm (1-1/8 inches) can be sewn.

→ Once sewing is completed, the machine automatically sews reinforcement stitches, then stops.

- 2 Attach buttonhole foot “A”.**

- 3 Select stitch  or .**

- 4** Position the fabric so that the needle is 2 mm (1/16 inch) in front of the area to be darned.

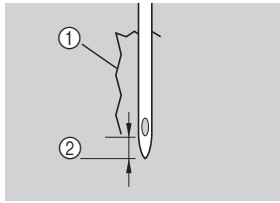

- ① Tear  
② 2 mm (1/16 inch)

Pass the upper thread down through the hole in the presser foot, and then lower the presser foot.

- When lowering the presser foot, do not push in the front of the presser foot, otherwise the darning will not be sewn with the correct size.

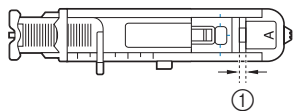
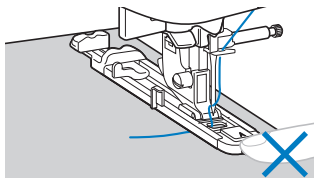

- ① Do not reduce the gap.

- 5** Pull down the buttonhole lever as far as possible.

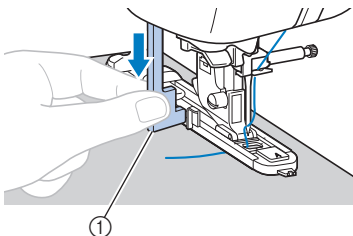

- ① Buttonhole lever  
The buttonhole lever is positioned behind the bracket on the buttonhole foot.

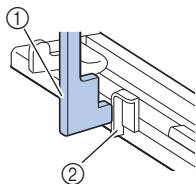

- ① Buttonhole lever  
② Bracket

- 6** Gently hold the end of the upper thread in your left hand, and then start sewing.

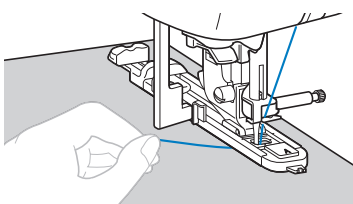

- 7** Raise the presser foot lever, remove the fabric, and then cut the threads.

- 8** Raise the buttonhole lever to its original position.



### Memo

- If the fabric does not feed, for example, because it is too thick, increase the stitch length. For details, refer to "Setting the stitch length" in the "Basic operations" section.

## Eyelet Stitching

Eyelets, such as those on belts, can be sewn.

- Using the table below, refer to "Using the utility stitch tables in the "Sewing" section" in the "Basic operations" section.

Stitch name	Stitch	Model 4	Model 3, 2		Model 1	Presser foot
			Stitch number			
Eyelet stitch		4-15	91	71	N	

- Attach monogramming foot "N".

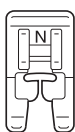

- Select stitch .

- Adjust either the stitch width or the stitch length to select the desired eyelet size.

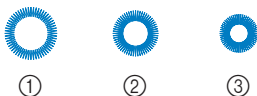

- ① 7mm
- ② 6mm
- ③ 5mm

- For details, refer to "Setting the stitch width" and "Setting the stitch length" in the "Basic operations" section.

- Lower the needle into the fabric at the beginning of the stitching, and then lower the presser foot lever.

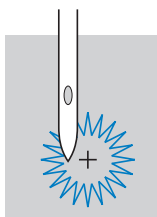

- Start sewing.

→ Once sewing is completed, the machine automatically sews reinforcement stitches, then stops.

- Use the eyelet punch to cut a hole in the center of the eyelet.

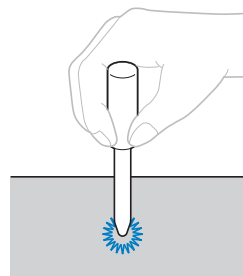

- When using the eyelet punch, place thick paper or some other protective sheet under the fabric before punching the hole in the fabric.

### Memo

- If thin thread is used, the stitching may be too open. If this occurs, sew the eyelet twice before removing the fabric, one on top of the other.

# Attaching Patches or Emblems to Shirt Sleeves

Use these stitch patterns to attach patches or emblems to pant legs, shirt sleeves, etc.

- Using the table below, refer to "Using the utility stitch tables in the "Sewing" section" in the "Basic operations" section.

Stitch name	Stitch	Model 4	Model 3, 2		Presser foot
			Model 3, 2	Model 1	
Stitch number					
Reverse (Straight stitch)	↑↓	5-01	92	—	N
Sideways to left (Straight stitch)	←	5-02	93	—	
Sideways to right (Straight stitch)	→	5-03	94	—	
Forward (Straight stitch)	↓	5-04	95	—	
Sideways to left (Zigzag stitch)	↔	5-05	96	—	
Sideways to right (Zigzag stitch)	↔	5-06	97	—	
Forward (Zigzag stitch)	↕	5-07	98	—	
Reverse (Zigzag stitch)	↕	5-08	99	—	

Insert the tubular piece of fabric onto the free-arm, and then sew in the order shown in the illustration.

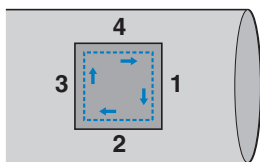

- Remove the flat bed attachment.
- Attach monogramming foot "N".

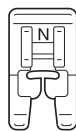

- Select stitch ↓↑.

- Lower the needle into the fabric at the beginning of the stitching, and then start sewing.

Lower the needle at the upper-right corner.

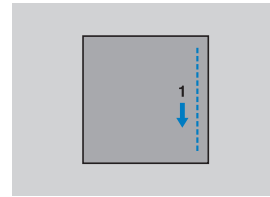

→ The fabric is fed toward the back of the machine, as usual.

- After you have sewn to the corner, stop the machine, and then select stitch ←.

- Start sewing.

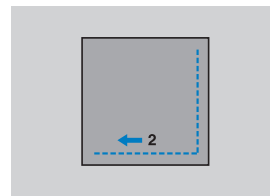

→ The fabric is fed to the right.

- After you have sewn to the corner, stop the machine, and then select stitch ↓↑.

- Start sewing.

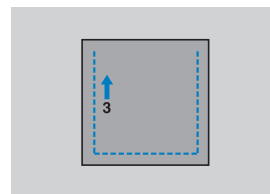

→ The fabric is fed forward.

- After you have sewn to the corner, stop the machine, and then select stitch →.

- Start sewing.

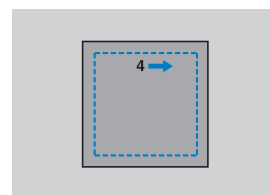

→ The fabric is fed to the left.



UTILITY STITCHES

**11** After you have sewn to the corner, stop the machine, and then select stitch  again.

**12** After sewing 3 to 5 stitches at the beginning of the stitching, stop the machine.























### Memo

- The feeding direction of the fabric differs depending on the stitch that is selected. Be sure to guide the fabric while machine is sewing.
-

## Decorative Stitching

The utility stitches contain the following decorative stitches.

- Using the table below, refer to "Using the utility stitch tables in the "Sewing" section" in the "Basic operations" section.

Stitch name	Stitch	Model 4	Stitch number		Presser foot
			Model 3, 2	Model 1	
Patchwork join stitch		2-07	42	36	J
Patchwork double overlock stitch		2-08	43	37	
Couching stitch		2-09	44	38	
Shell tuck edge stitch		2-04	39	34	
Smocking stitch		2-10	45	39	
Feather stitch		2-11	46	40	
Fagoting cross stitch		2-12	47	41	
Satin scallop stitch		2-05	40	35	N
Hemstitching		3-04	58	48	
		3-06	60	50	
		3-09	63	-	
		3-10	64	52	
Honeycomb stitch		3-12	66	-	
Hemstitching		3-18	72	56	
		3-20	74	-	
		3-21	75	-	
		3-22	76	-	
Ladder stitch		2-14	49	43	J
Rick-rack stitch		2-15	50	44	
Decorative stitch		2-16	51	45	
Serpentine stitch		2-17	52	46	N

## Fagoting

Stitching across an open seam is called "fagoting". It is used on blouses and children's clothing. This stitch is more decorative when thicker thread is used.

- Use an iron to fold the two pieces of fabric along their seams.
- Baste the two pieces of fabric, separated by about 4 mm (3/16 inch), onto thin paper or a sheet of water-soluble stabilizer.

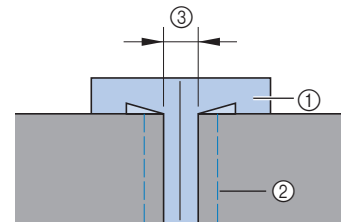

If you draw a line down the middle of the thin paper or water-soluble stabilizer, sewing is easier.

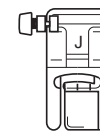

- Thin paper or water soluble stabilizer
- Basting stitching
- 4 mm (3/16 inch)

- Attach zigzag foot "J".



- Select stitch  or .
- Set the stitch width to 7.0 mm (1/4 inch).
- Sew with the center of the presser foot aligned along the center of the two pieces of fabric.

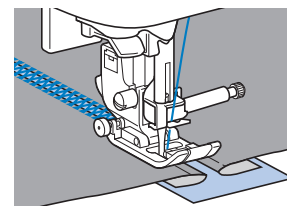
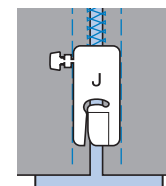



- After sewing is finished, remove the paper.

## Scallop stitching

The wave-shaped repeated pattern that looks like shells is called “scalloping”. It is used on the collars of blouses and to decorate the edges of projects.

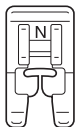
- 1 Attach monogramming foot “N”.



- 2 Select stitch .

- 3 Stitch along the edge of the fabric, making sure not to sew directly on the edge of the fabric.

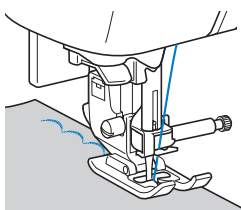

- For better results, apply spray starch onto the fabric and press with a hot iron before it is sewn.

- 4 Trim along the stitches.

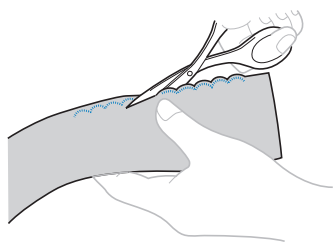

- Be careful not to cut the stitches.

## Smocking

The decorative stitch created by stitching or embroidering over gathers is called “smocking”. It is used to decorate the front of blouses or cuffs.

The smocking stitch adds texture and elasticity to fabric.

- 1 Attach zigzag foot “J”.

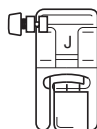

- 2 Select the straight stitch, and then adjust the stitch length to 4.0 mm (3/16 inch) and loosen the thread tension.

- For details, refer to “Setting the stitch length” and “Setting the thread tension” in the “Basic operations” section.
- For details, refer to “Pulling up the bobbin thread” in the “Basic operations” section.

- 3 Sew parallel stitching at intervals of 1 cm (3/8 inch).

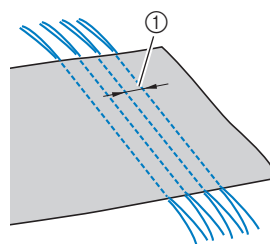

- ① 1 cm (3/8 inch)

- Do not use reverse/reinforcement stitching or thread cutting.
- At the end of the stitching, the thread is pulled out about 5 cm (2 inches).

- 4 Pull the bobbin threads to create gathers. Smooth the gathers by ironing them.

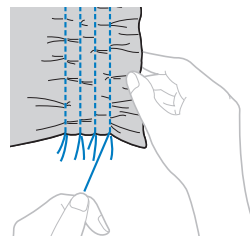

- 5 Select stitch ,  or .

- 6 Stitch between the straight stitches.

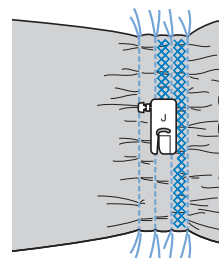

- 7 Pull out the threads for the straight stitches.

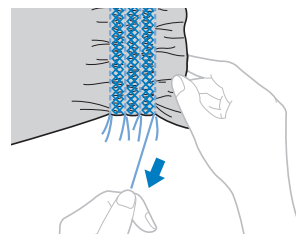

## Shell tuck stitching

The gathers that look like shells are called “shell tucks”. They are used to decorate trims, the front of blouses or cuffs made of thin fabrics.

- 1 Fold the fabric along the bias.

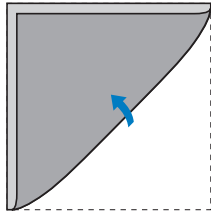

- 2 Attach zigzag foot “J”.

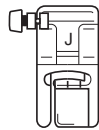

- 3 Select stitch , and then increase the thread tension.

- 4 Sew while making sure that the needle drops slightly off the edge of the fabric.

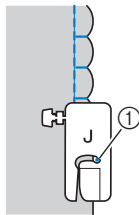

- 1 Needle drop point

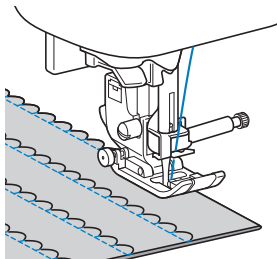

- 5 Unfold the fabric, and then iron the tucks down to one side.

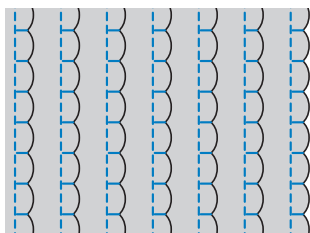

## Joining

Decorative bridging stitches can be sewn over the seam allowance of joined fabrics. This is used when making a crazy quilt.

- 1 Attach zigzag foot “J”.

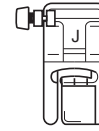

- 2 Sew together the right sides of the two pieces of fabric, and then open up the seam allowances.

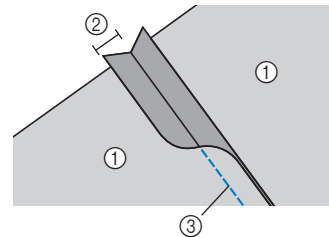

- 1 Wrong side of fabric
- 2 7 mm (1/4 inch) seam allowance
- 3 Straight stitch

- 3 Select stitch ,  or .

- 4 Turn the fabric over so that the right side faces up, and then sew over the seam with the center of the presser foot aligned with the seam.

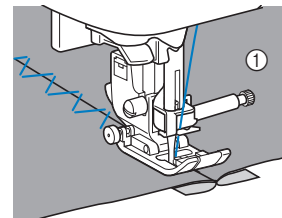

- 1 Right side of fabric



## Heirloom stitching

When sewing with the wing needle, the needle holes are enlarged, creating a lace-like decorative stitch. This is used to decorate hems and tablecloths on thin or mediumweight fabrics in addition to plain weave fabrics.

### 1 Install the wing needle.



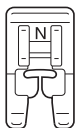

- Use a 130/705H 100/16 wing needle.
- For details on installing a needle, refer to “Replacing the Needle” in the “Basic operations” section.
- The needle threader cannot be used with the wing needle, otherwise the machine may be damaged. Manually pass the thread through the eye of the needle from the front to the back. For details, refer to “Threading the needle manually (without using the needle threader)” in the “Basic operations” section.

### 2 Attach monogramming foot “N”.



### 3 Select a stitch.

The stitches that can be used are   
 or .

- When sewing with the wing needle, select a stitch width of 6.0 mm (15/64 inch) or less.

### 4 Start sewing.

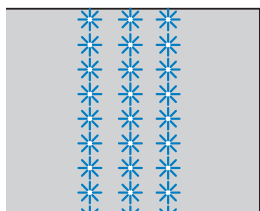

## ⚠ CAUTION

- When sewing with the wing needle, select a stitch width of 6.0 mm (15/64 inch) or less, otherwise the needle may bend or break.
- After adjusting the stitch width, slowly turn the handwheel toward you (counterclockwise) and check that the needle does not touch the presser foot. If the needle hits the presser foot, the needle may bend or break.

Partially removing threads is called “drawnwork”. This gives beautiful results with fabrics that have a loose weave.

Two ways to create drawnwork are described below.

### ■ Drawnwork (Example 1)

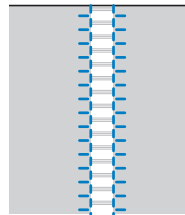

### 1 Pull out several threads from the fabric.

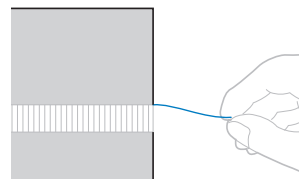

### 2 Attach monogramming foot “N”.

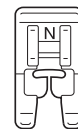

### 3 Select stitch .

### 4 With the right side of the fabric facing up, sew along the right edge of the frayed section.

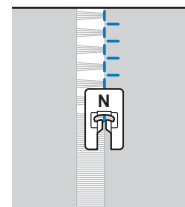

### 5 Press the mirror image key.

- For details, refer to “Mirroring stitches” in the “Basic operations” section.  
 → The pattern displayed on the screen is mirrored.

### 6 Sew along the other edge of the frayed section so that it looks like the previous stitching.

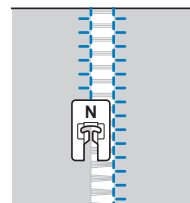

### 7 Press the mirror image key again to return to normal mode.

## ■ Drawnwork (Example 2)

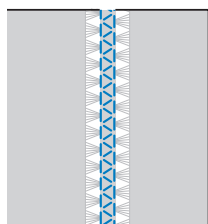

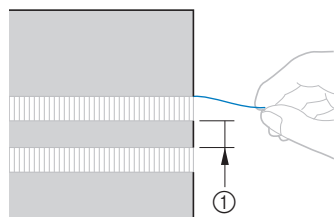

- 1 Pull out several threads from two sections of the fabric, separated by an unfrayed section of about 4 mm (3/16 inch).

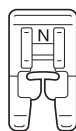

① 4 mm (3/16 inch)

- 2 Attach monogramming foot "N".



- 3 Select stitch .

- 4 Sew along the center of the unfrayed section.

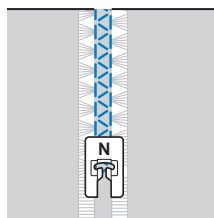



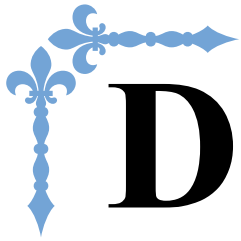

# Decorative sewing

This section provides instructions on sewing character stitches and decorative stitches as well as on adjusting and editing them. In addition, it describes how to use MY CUSTOM STITCH, which allows you to create original stitch patterns.

Page number starts with “D” in this section.

The screen display and machine illustration may vary slightly, depending on the machine model.

**Chapter1 CHARACTER / DECORATIVE STITCHES..... D-2**

---

**Chapter2 MY CUSTOM STITCH..... D-12**

---

## CAUTION

- Before replacing the presser foot, be sure to press  (Presser foot/Needle exchange key) on the operation panel to lock all keys and buttons, otherwise injuries may occur if the “Start/Stop” button or any other button is pressed and the machine starts. For details on changing the presser foot, refer to “Replacing the Presser Foot” in the “Basic operations” section.

# Chapter 1 CHARACTER / DECORATIVE STITCHES

## Sewing the Various Built-in Decorative Patterns

### Selecting stitch patterns

This machine is equipped with the following decorative stitches and character stitches.

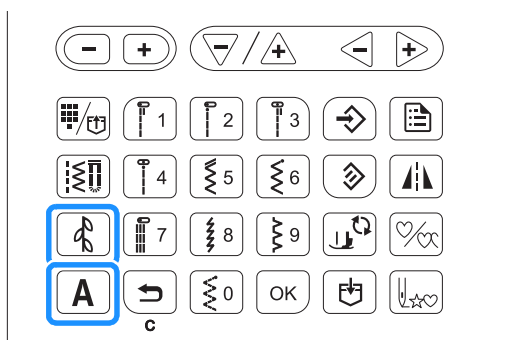

#### Note

- The stitch numbers vary depending on your sewing machine model. Refer to the Quick Reference Guide.

### Decorative stitch patterns

Operation key	Included stitches	Icon
	Decorative stitches MY CUSTOM STITCH (No. 97)	
	Satin stitches 7 mm satin stitches Cross stitch stitches	
	Utility decorative stitches	

The category contains the following three types of stitches. Availability of stitches vary depending on your machine model. Refer to the Quick Reference Guide.

#### Satin stitches



#### 7 mm satin stitches



### Cross stitch stitches



### Character stitch patterns

Operation key	Font	Icon
A	Gothic	
	Handwriting	
	Outline	
	Cyrillic	
	Japanese	

To select a character/decorative stitch, press or **A**, and then use the numeric keys to specify the number of the desired stitch.

### Decorative stitch patterns

Each press of changes the decorative stitch category in the following order.

1 → 2 → 3 → 1 ...

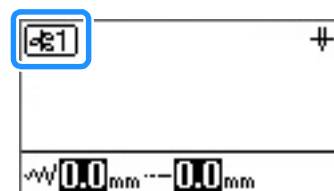

Select the category containing the desired stitch, and then specify the number of the stitch.

### Memo

- For stitches 01 through 09, the stitch can also be selected by using the numeric keys to type in a one-digit number, then pressing **OK**.
- When using one-digit numbers and it is entered incorrectly, press to erase the entered number.

## Character stitch patterns

Each press of **A** changes the font in the following order.

**AB** → **AB** → **AB** → **AB** → **AB** → **AB**...



Select the desired font, and then specify the numbers of the desired characters.

## Memo

- When selecting a pattern from a category containing over 100 patterns, the pattern can be selected by entering its three-digit number (for example, 001) without pressing **OK**. When one or two digits are entered and if the pattern cannot be selected with the entered number, press **OK** to confirm the pattern number.

## Deleting a pattern

To remove a selected pattern, press **C** on the operation panel.

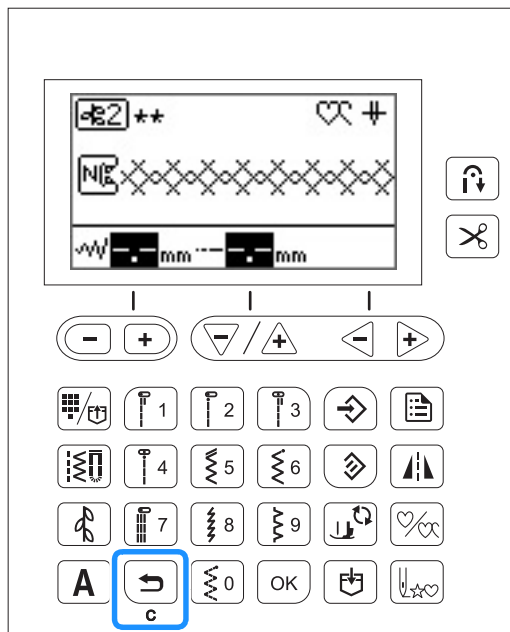

→ The selected pattern is removed.

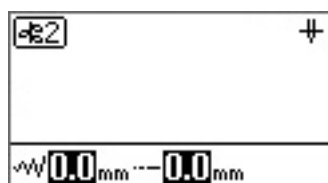

## Memo

- If a new pattern is selected without deleting the previously selected one, the first and second patterns are combined. (Refer to “Combining patterns” on page D-5.)
- If two patterns or more have been already selected, the pattern that was selected last is removed.

## Sewing attractive finishes

To achieve attractive results when sewing character/decorative stitches, check the table below for the proper fabric/thread/needle combinations.

## Note

- Other factors, such as fabric thickness, stabilizer material, etc., also have an effect on the stitch, so you should always sew a few trial stitches before beginning your project.
- It may be necessary to adjust the pattern, depending on the type of fabric being sewn or the sewing speed. Adjust the pattern while sewing trial stitches on a scrap piece of fabric that is the same as what is used in your project. Refer to “Realigning the pattern” on page D-10.
- When sewing satin stitch patterns, there may be shrinking or bunching of stitches, so be sure to attach a stabilizer material.
- Guide the fabric with your hand to keep the fabric feeding straight and even during sewing.

Fabric	When sewing on stretch fabrics, lightweight fabrics, or fabrics with coarse weaves, attach stabilizer on the wrong side of the fabric. An alternative would be to place the fabric on thin paper such as tracing paper. <div style="text-align: center;"> </div> <div style="margin-left: 20px;"> <p>① Fabric ② Stabilizer ③ Thin paper</p> </div>
Thread	#50 - #60
Needle	With lightweight, regular, or stretch fabrics: the Ball point needle (golden colored) 90/14 With heavyweight fabrics: home machine needle 90/14
Presser foot	Monogramming foot “N”. Using zigzag foot “J” or other presser feet may give inferior results.
Twin needle	You can sew with twin needle (2.0/11) when you select 7 mm satin stitch pattern. In this case, use zigzag foot “J”.

## Basic sewing

- 1 Select a decorative/character stitch pattern.
- 2 Attach monogramming foot "N".
- 3 Place the fabric under the presser foot, pull the upper thread out to the side, press  (Needle position button) to lower needle into fabric and then lower the presser foot.

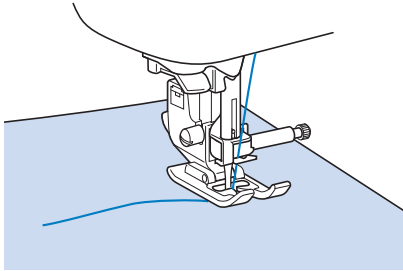



- 4 Press the "Start/Stop" button to begin sewing.

### CAUTION

- When sewing 7 mm satin stitch patterns and the stitches are bunched, lengthen the stitch length. If you continue sewing when the stitches are bunched, the needle may bend or break. For details on adjusting the stitch length, refer to "Setting the stitch length" in the "Basic operations" section.

### Memo

- If the fabric is pulled or pushed during sewing, the pattern may not turn out correctly. Also, depending on the pattern, there may be movement to the left and right as well as front and back. Guide the fabric with your hand to keep the fabric feeding straight and even during sewing.

- 5 Press the "Start/Stop" button to stop sewing.
- 6 Press  (Reverse stitch button) or  (Reinforcement stitch button) to sew reinforcement stitches.

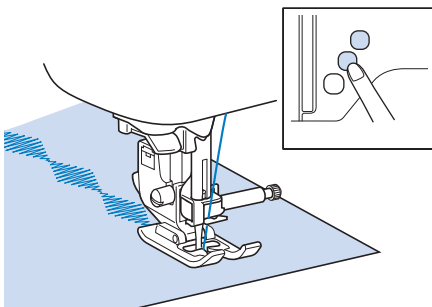

### Memo

- When sewing character stitches, the machine automatically sews reinforcement stitches at the beginning and end of each character.

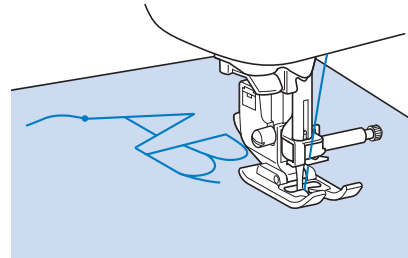

- When sewing is completed, trim any excess thread between letters.

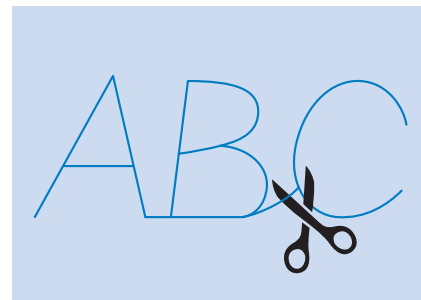

### Note

- When sewing some patterns, the needle will temporarily pause in the raised position while the fabric is fed due to the operation of the needle bar separation mechanism which is used in this machine. At such times, a clicking sound different from the sound generated during sewing will be heard. This sound is normal and is not the sign of a malfunction.

## Combining patterns

### 1 Select the first category and pattern.

→ The selected pattern appears on the screen.



- When the sewing is started, the selected pattern is sewn repeatedly until the sewing machine is stopped.

### 2 Select the next category and pattern.

→ The combined pattern appears on the screen.



- To remove a selected pattern, press on the operation panel. The pattern that was selected last is removed.

### 3 After all of the desired patterns are selected, start sewing.



→ The order that the patterns appear on the screen is the order that they will be sewn.

#### Memo

- Up to 70 patterns can be combined.
- If multiple patterns have been combined, the sewing machine stops once all the selected patterns displayed in the LCD have been sewn. To repeatedly sew the combined pattern, refer to "Repeating combined patterns" on page D-5.
- The combined pattern can be stored for later use. For details, refer to "Saving a pattern" on page D-9.
- When you created a combined pattern using a pattern which allows stitch width/length adjustment and one which does not allow, you can adjust the stitch width/length of the created pattern. However, the changed value will be applied only to the pattern which allows stitch width/length adjustment.

## Repeating combined patterns

When multiple stitches are combined, the sewing machine stops when the pattern displayed on the screen has been completed. Use the following operations to sew a combined pattern repeatedly.

### 1 After the patterns have been combined, press .

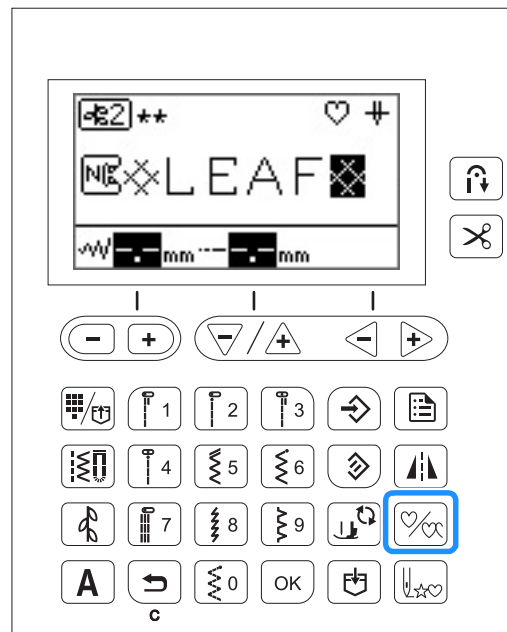

→ on the LCD screen turns to , and you can now sew the specified pattern repeatedly.



→ If pressed again, it turns to (single sewing).

#### Note

- If repeated sewing is set, the pattern is repeatedly sewn until the sewing machine is stopped.
- If the sewing machine is turned off, the repeated/single sewing setting returns to its default setting.



## Checking the selected pattern

When the specified pattern is not displayed on the screen, check the pattern using the following steps.

- 1 Select  ABC (Check) in the settings screen.



- 2 Press the “-” or “+” key, and confirm the pattern.

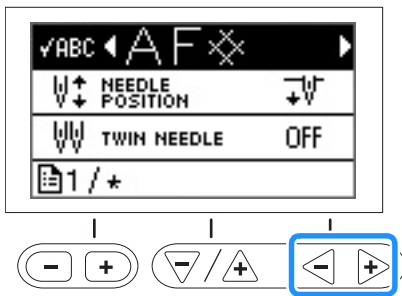

- 3 Press .

### Memo

- The combined pattern can be stored for later use. For details, refer to “Saving a pattern” on page D-9.

## Changing the pattern size

The size of character stitches (except handwriting font) can be switched between large and small. Depending on your machine model, the size of Handwriting font characters, Decorative stitches, Satin stitches can be also changed. Refer to “Functions available with each model” in the “Basic operations” section.)

- 1 Select a stitch.
- 2 Display  (Size selection) in the settings screen, and select  (Large) or  (Small).



- Large

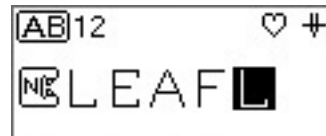

- Small



- 3 Repeat steps 1 and 2.



LEAFLEAF

## Changing the stitch density

If a satin stitch has been selected, the stitch density can be changed.

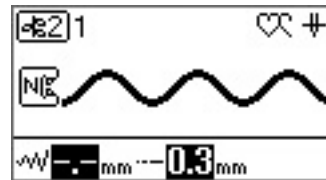
- 1 Select a satin stitch pattern.



- 2 Select  (Thread density) in the settings screen, and select the desired stitch density. Select  for coarser stitching, or select  for finer stitching.

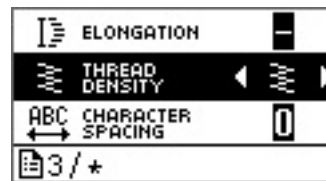

## CAUTION

- If the stitching density is too fine, depending on the needle, the stitches may be bunched together, causing the needle to break.

## Changing the pattern length

The length of one part of a 7 mm satin stitch can be set to one of five sizes.

- 1 Select a 7 mm satin stitch pattern.

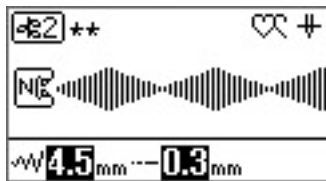

- 2 Select  (Elongation) in the settings screen, and select the desired length from among "1" to "5".

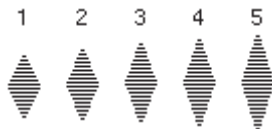
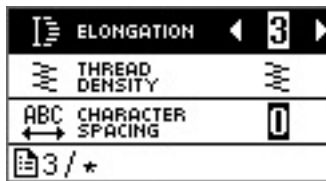

## Changing character spacing

- 1 Select character stitches.
- 2 Select  (Character spacing) in the settings screen.
- 3 Adjust the character spacing by pressing the "-" or "+" key.

The higher the setting, the wider the character spacing will be; the lower the setting, the narrower the character spacing will be.

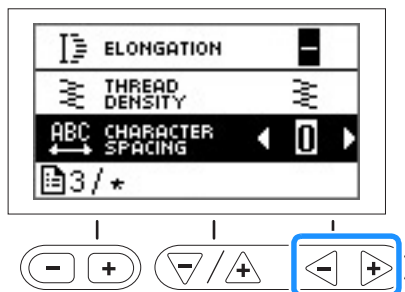

## Creating step stitch patterns

### (For models equipped with step stitch patterns)

Decorative stitches can be shifted to the left or right by half the width of the pattern, allowing you to create a step-shaped pattern. (Equipped on some models. Refer to page B-8.) This is called a "step stitch pattern". As an example, the procedure for creating the following pattern is described below.



- 1 Select a decorative stitch.

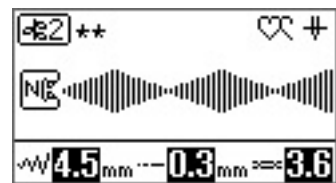

- 2 Press  .

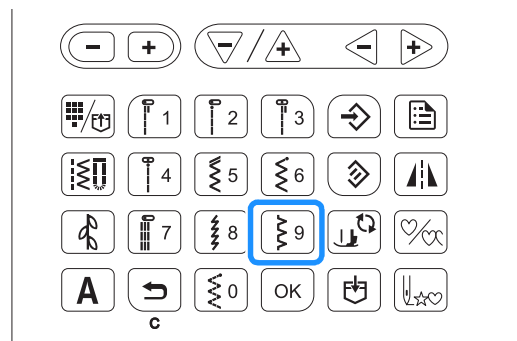

→ The next pattern selected is moved half a width to the right.

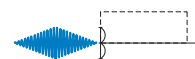

- 3 Select the same pattern.

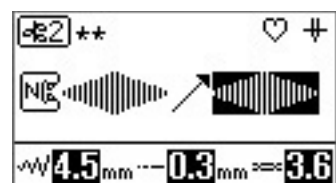

4 Press .

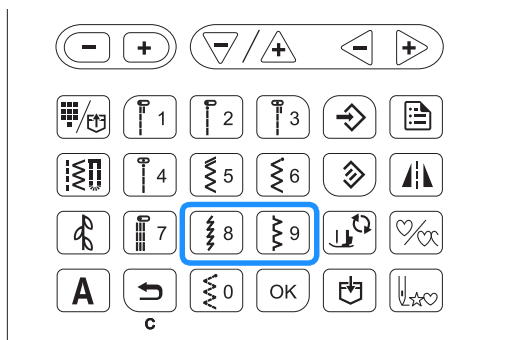

→ The next pattern selected is moved half a width to the left.



5 Press to specify that the patterns will be sewn repeatedly.

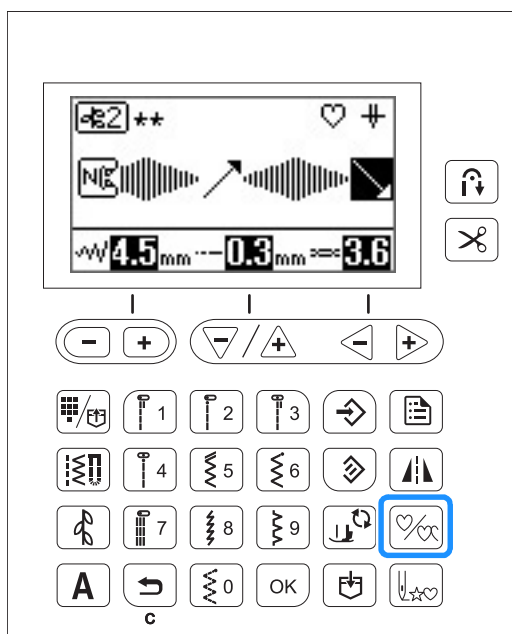

• For details, refer to “Repeating combined patterns” on page D-5.

### ■ Examples of step stitch patterns

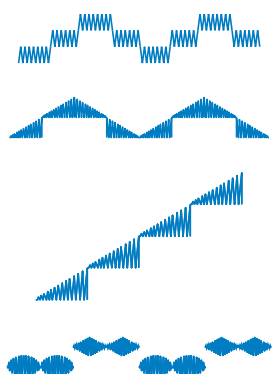

### Mirroring a pattern image

1 After a single pattern has been selected, press to mirror the pattern image horizontally.

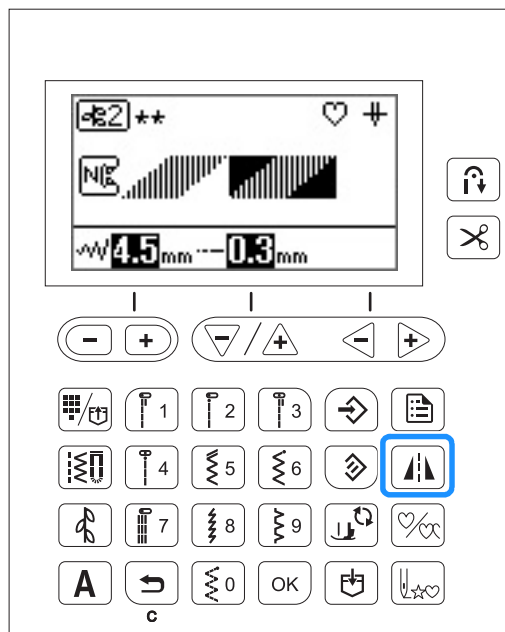

→ appears on the screen and the selected stitch is mirrored.

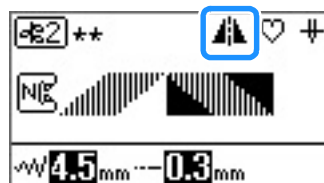

## Returning to the beginning of the pattern

You can return to the beginning of the pattern after trial sewing or when the stitching is sewn incorrectly.

- 1 Press the "Start/Stop" button to stop the machine, and then press .



→ Sewing returns to the beginning of the selected pattern ("W") from the point where sewing was stopped.

### Memo

- If this key is pressed when sewing is stopped, patterns can be added at the end of a combined stitch pattern. (In this example, "!" is added.)



- 2 Press the "Start/Stop" button to continue sewing.

## Saving a pattern

Combined patterns can be stored for later use. Since stored patterns are not lost after the sewing machine is turned off, they can be recalled at any time. Up to 15 patterns can be stored.

- 1 Create the combined pattern that you wish to store.
  - For details, refer to "Combining patterns" on page D-5.
- 2 Press  on the operation panel.

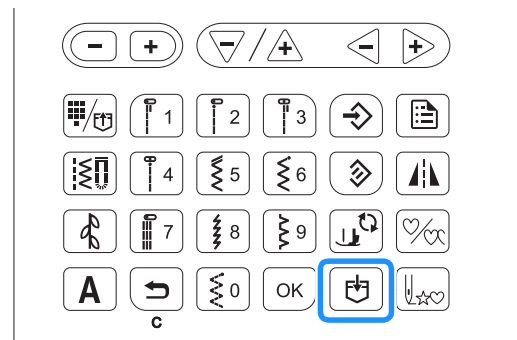







→ A screen showing the list of pockets appears, and an empty pocket is selected.

- 3 Press .

- Do not turn off the sewing machine while the pattern is being stored, otherwise the pattern data may be lost.

### Memo

- To select the pocket where the pattern is to be saved, press  or  to specify the desired pocket, and then press .
- If the pattern is saved in a pocket where a stitch is already saved, the stitch is overwritten.
- If an empty pocket is not available, select a pocket which contains a pattern that can be overwritten.
- Use   to scroll the selected pocket horizontally to confirm the whole pattern.
- Once the pattern has been saved in pocket, it can not be deleted without overwriting. When you wish to delete a pattern in the pocket, press  without selecting a pattern.

## Retrieving a pattern

- 1 Press once or twice until a list of saved patterns like the one shown below is displayed.



- 2 Select the desired saved pattern using / or / .



→ The selected pocket is shown in reverse highlighting, and the stored pattern is displayed.

### Memo

- Use to scroll the selected pattern horizontally to confirm the whole pattern.



- 3 Check the contents, and then press .

## Realigning the pattern

The pattern may not be sewn correctly, depending on the type of fabric being sewn or the sewing speed. If this occurs, adjust the pattern while sewing on a piece of scrap fabric that is the same as what is used for your project.

The pattern used for making adjustments differs depending on the sewing machine model.

For models equipped with vertical and horizontal fine

adjustment settings: (No. 36 or 80 of )

For models equipped with only vertical fine adjustment

settings: (No. 31 of )

- 1 Attach monogramming foot “N”.

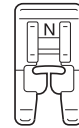

- 2 Select or .

- 3 Start sewing.

→ The sewing machine stops after it has finished sewing the pattern.

- 4 Check the sewn pattern.

If the part of the pattern indicated in the illustration is sewn uniformly, the pattern is correctly aligned.



If the pattern appears as shown below, the stitching is misaligned in the vertical direction.

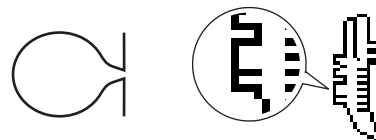
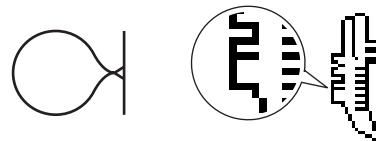

(For models equipped with horizontal fine adjustment settings)

If the pattern appears as shown below, the stitching is misaligned in the horizontal direction.



If the pattern is not sewn correctly, follow the steps below to adjust the sewing.

- 5 Select (Fine adjustment – vertical) in the settings screen.

- 6 Press the “-” or “+” key to adjust the vertical position.

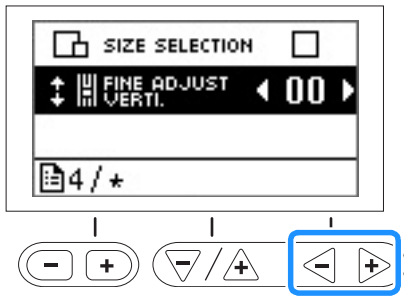

→ Make the necessary adjustments according to how the pattern is sewn.

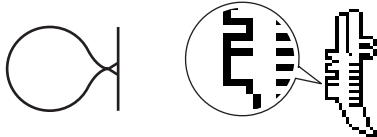

Press “+” to increase the vertical space in the design.

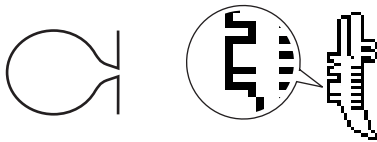

Press “-” to decrease the vertical space in the design.

For users of models equipped with horizontal fine adjustment settings:

Go to step 7.

For users of models equipped with only vertical fine adjustment settings:

Go to step 9.

- 7 Select  $\leftrightarrow$  (Fine adjustment – horizontal) in the settings screen.

- 8 Press the “-” or “+” key to adjust the horizontal position.

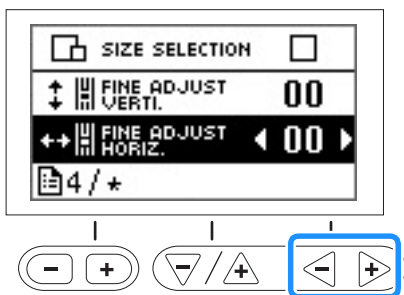

→ Make the necessary adjustments according to how the pattern is sewn.





Press “+” to increase the horizontal space in the design.



Press “-” to decrease the horizontal space in the design.

- 9 Press  $\rightarrow$ .

- 10 Select  or  once again, start the sewing machine and check the stitching.

Continue adjusting the pattern until it is sewn correctly.

# Chapter 2 MY CUSTOM STITCH

## Designing a Stitch

With the MY CUSTOM STITCH function, you can sew stitch patterns that you design yourself

### Drawing a sketch of the pattern

Prepare a grid sheet set.



**1** Draw a sketch of the pattern on the grid sheet set.

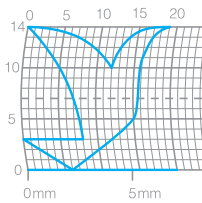

Draw the pattern as one continuous line and with the start point and the end point of the design at the same height.



**2** If the pattern will be repeated, determine the space between the repeating patterns.

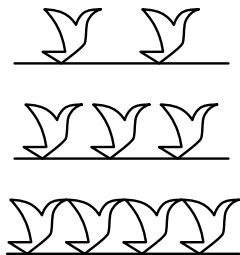
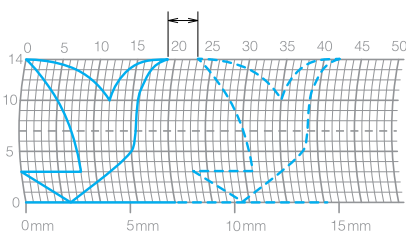

**3** Mark the points in the pattern that are positioned at intersections in the grid, and then link those points with a continuous straight line.

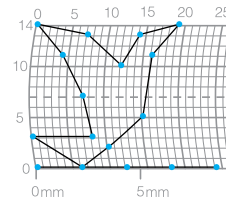

**4** Determine the sewing order.

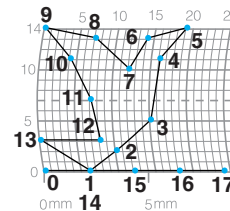

For a more attractive stitch, close the pattern by intersecting the line.



### Entering the pattern data

**1** Attach monogramming foot "N".

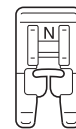

- 2 Press on the operation panel as many times as necessary until is displayed, and press .

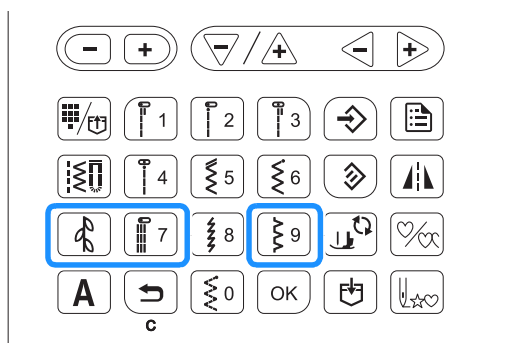

→ The MY CUSTOM STITCH screen is displayed.

- 3 Check the grid sheet set, and specify the coordinates of the first point. Specify the coordinates using the “-” and “+” keys, and press .

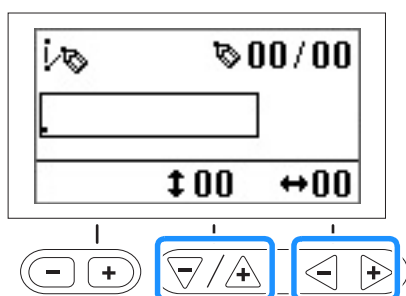

- 4 Specify the coordinates of the second point, and then press .

- 5 Specify whether single stitching or triple stitching will be sewn between the points.

Select either of them using the “-” or “+” key, and then press .

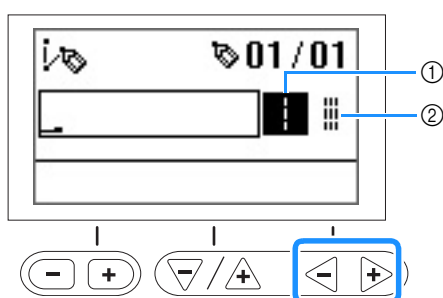

- ① Single stitching  
② Triple stitching

- 6 Select whether to finish editing the pattern and return to the sewing screen or to continue editing.

Select either of them using the “-” or “+” key, and then press .

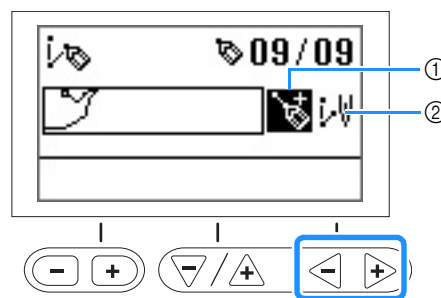

- ① Continue editing  
② Finish editing

- 7 Repeat steps 4 through 6 to specify each point.

**Note**

- To correct an entered point, press when the screen appears as shown below.

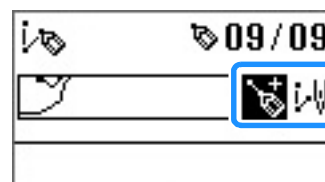

Press once to highlight the last point in white. Press again to select the previous point.

To select the next point, press .

After selecting the point to be corrected, you can move it using the “-” and “+” keys.

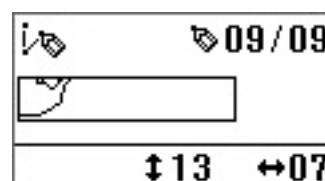

- The last point can be deleted by pressing while the point appears black in the screen where is displayed.

- 8 After all points have been entered, select .

- 9 Specify the various stitching settings, such as reverse/reinforcement stitching, in the same way as with other stitches.

**Note**

- The pattern you entered can be stored for later use. For details, refer to “Saving a pattern” on page D-9.



## Examples of designs

Enter each of the points indicated in the table to sew the sample stitch.



Point	↔	↑↓	Point	↔	↑↓
1	0	0	21	38	13
2	12	0	22	35	14
3	18	3	23	32	13
4	22	6	24	30	10
5	23	10	25	32	6
6	21	13	26	35	3
7	17	14	27	41	0
8	14	13	28	45	0
9	12	11	29	47	4
10	9	13	30	44	7
11	6	14	31	45	11
12	3	13	32	47	13
13	1	10	33	50	14
14	3	6	34	54	13
15	6	3	35	56	10
16	12	0	36	55	6
17	41	0	37	51	3
18	43	4	38	45	0
19	40	7	39	70	0
20	41	11			



Point	↔	↑↓	Point	↔	↑↓
1	0	0	21	16	10
2	3	5	22	18	12
3	5	8	23	21	13
4	8	11	24	25	14
5	12	13	25	28	14
6	17	14	26	33	13
7	20	14	27	37	11
8	24	13	28	41	8
9	27	12	29	43	5
10	29	11	30	44	0
11	31	9			
12	32	6			
13	30	3			
14	27	1			
15	24	0			
16	21	0			
17	18	1			
18	16	3			
19	15	5			
20	15	8			



Point	↔	↑↓	Point	↔	↑↓
1	0	0	21	10	11
2	30	0	22	12	10
3	32	1	23	8	9
4	32	7	24	12	8
5	32	10	25	7	6
6	33	12	26	12	6
7	35	11	27	6	3
8	35	8	28	10	2
9	37	12	29	5	0
10	35	14	30	10	2
11	32	14	31	16	1
12	30	11	32	19	0
13	30	5	33	23	0
14	29	3	34	22	6
15	26	8	35	17	10
16	24	10	36	22	6
17	18	13	37	23	0
18	13	14	38	19	0
19	12	14	39	42	0
20	13	12			



Point	↔	↑↓	Point	↔	↑↓
1	0	7	21	20	11
2	5	7	22	21	7
3	4	3	23	24	7
4	5	7	24	23	14
5	8	7	25	24	7
6	7	0	26	27	7
7	8	7	27	27	11
8	11	7	28	27	7
9	11	3	29	32	7
10	11	7	30	27	11
11	16	7	31	23	14
12	11	3	32	20	11
13	7	0	33	16	7
14	4	3	34	20	3
15	0	7	35	23	0
16	4	11	36	27	3
17	7	14	37	32	7
18	11	11			
19	16	7			
20	21	7			

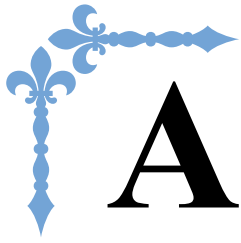

# Appendix

This section provides important information for operating this machine. Please read this section to find troubleshooting tips and pointers as well as how to keep your machine in the best working order. Page number starts with "A" in this section.

## **Chapter1 MAINTENANCE AND TROUBLESHOOTING ..... A-2**

---

# Chapter 1 MAINTENANCE AND TROUBLESHOOTING

## Care and Maintenance

### Restrictions on oiling

In order to prevent damaging this machine, it must not be oiled by the user.

This machine was manufactured with the necessary amount of oil applied to ensure correct operation, making periodic oiling unnecessary.

If problems occur, such as difficulty turning the handwheel or an unusual noise, immediately stop using the machine, and contact your authorized Brother dealer or the nearest Brother authorized service center.

### Precautions on storing the machine

Do not store the machine in any of the locations described below, otherwise damage to the machine may result, for example, rust caused by condensation.

- Exposed to extremely high temperatures
- Exposed to extremely low temperatures
- Exposed to extreme temperature changes
- Exposed to high humidity or steam
- Near a flame, heater or air conditioner
- Outdoor or exposed to direct sunlight
- Exposed to extremely dusty or oily environments



#### Note

- In order to extend the life of this machine, periodically turn it on and use it. Storing this machine for an extended period of time without using it may reduce its efficiency.

### Cleaning the LCD screen

If the screen is dirty, gently wipe it with a soft, dry cloth. Do not use organic solvents or detergents.



#### Note

- Do not wipe the LCD screen with a damp cloth.



#### Memo

- Occasionally, condensation may form on the LCD screen or it may become fogged up; however, this is not a malfunction. After a while, the cloudiness will disappear.

### Cleaning the machine surface

If the surface of the machine is dirty, lightly soak a cloth in neutral detergent, squeeze it out firmly, and then wipe the surface of the machine. After cleaning it once with a damp cloth, wipe it again with a dry cloth.

### ⚠ CAUTION

- **Unplug the power cord before cleaning the machine, otherwise injuries or an electric shock may occur.**

### Cleaning the race

Sewing performance will suffer if lint and dust collects in the bobbin case, therefore, it should be cleaned regularly.

- 1 Press (Needle position button) to raise the needle.
- 2 Turn off the machine.
- 3 Unplug the power cord from the power supply jack on the right side of the machine.

### ⚠ CAUTION

- **Unplug the power cord before cleaning the machine, otherwise injuries or an electric shock may occur.**

- 4 Raise the presser foot to remove the needle, presser foot and presser foot holder.
  - For details, refer to “Replacing the Needle” and “Replacing the Presser Foot” in the “Basic operations” section.
- 5 Remove the flat bed attachment if it is attached.
- 6 Remove the needle plate cover.

■ **If there is a screw in the needle plate cover**

- 1 Use the L-shaped (or disc-shaped) screwdriver to remove the screw in the needle plate cover.

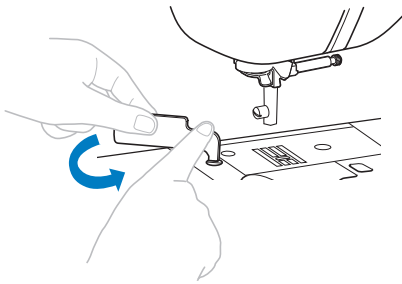

- 2 Grasp both sides of the needle plate cover, and then slide it toward you.

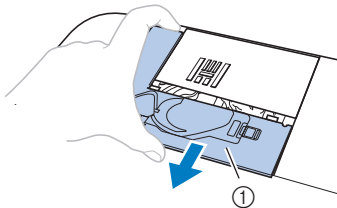

① Needle plate cover

■ **If there is no screw in the needle plate cover**

- 1 Grasp both sides of the needle plate cover, and then slide it toward you.

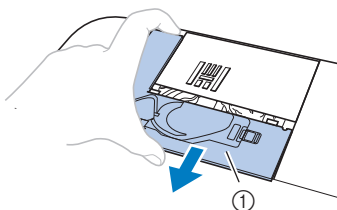

① Needle plate cover

**7** **Remove the bobbin case.**

- 1 Grasp the bobbin case, and then pull it out.

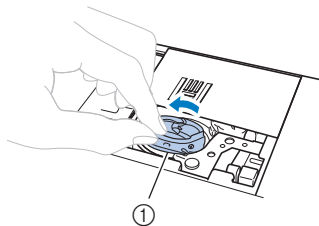

① Bobbin case

**8** **Use the cleaning brush or a vacuum cleaner to remove any lint and dust from the race and the surrounding area.**

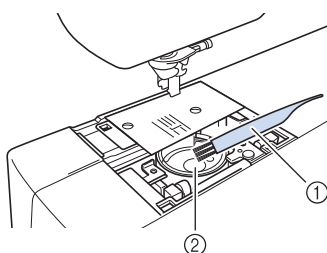

① Cleaning brush  
② Race

- Do not apply oil to the bobbin case.

**9** **Insert the bobbin case so that the ▲ mark on the bobbin case aligns with the ● mark on the machine.**

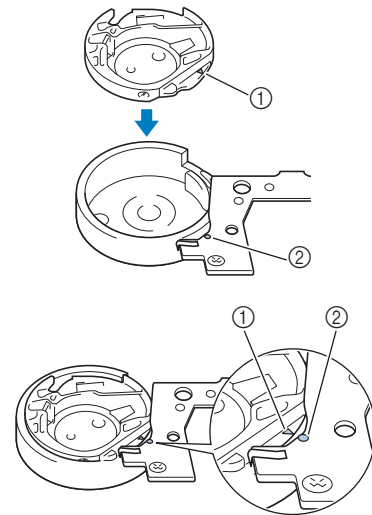

- Align the ▲ and ● marks.

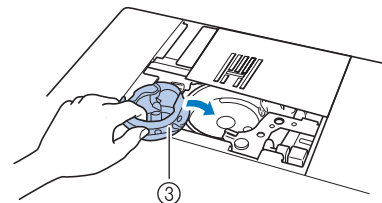

① ▲ mark  
② ● mark  
③ Bobbin case

- Make sure that the indicated points are aligned before installing the bobbin case.

**10** **Insert the tabs on the needle plate cover into the needle plate, and then slide the cover back on.**

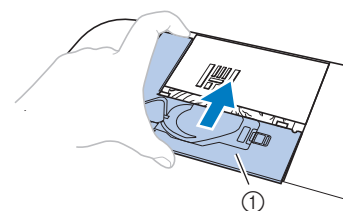

① Needle plate cover

**⚠ CAUTION**

- Never use a bobbin case that is scratched, otherwise the upper thread may become tangled, the needle may break or sewing performance may suffer. For a new bobbin case, contact your nearest Brother authorized service center.
- Be sure that the bobbin case is correctly installed, otherwise the needle may break.

## Troubleshooting

If the machine stops operating correctly, check the following possible problems before requesting service. You can solve most problems by yourself. If you need additional help, the Brother Solutions Center offers the latest FAQs and troubleshooting tips. Visit us at "<http://support.brother.com/>".

If the problem persists, contact your authorized Brother dealer or the nearest Brother authorized service center.

### Frequent troubleshooting topics

Detailed causes and remedies for common troubleshooting topics are described below. Be sure to refer to this before contacting us.

Upper thread tightened up	page A-4
Tangled thread on wrong side of fabric	page A-5
Incorrect thread tension	page A-6
Fabric is caught in the machine and cannot be removed	page A-8
When the thread becomes tangled under the bobbin winder seat	page A-10

### Upper thread tightened up

#### ■ Symptom

- The upper thread appears as a single continuous line.
- The lower thread is visible from the upper side of the fabric. (Refer to the illustration below.)
- The upper thread has tightened up, and comes out when pulled.
- The upper thread has tightened up, and wrinkles appear in the fabric.
- The upper thread tension is tight, and the results do not change even after the thread tension is adjusted.

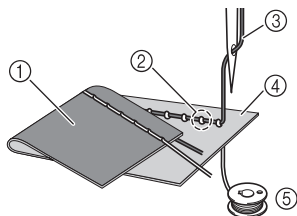

- ① Wrong side of fabric
- ② Bobbin thread visible from right side of fabric
- ③ Upper thread
- ④ Right side of fabric
- ⑤ Bobbin thread

#### ■ Cause

##### Incorrect bobbin threading

If the bobbin thread is incorrectly threaded, instead of the appropriate tension being applied to the bobbin thread, it is pulled through the fabric when the upper thread is pulled up. For this reason, the thread is visible from the right side of the fabric.

#### ■ Remedy/check details

Correctly install the bobbin thread.

- 1 Press , and raise the presser foot lever.
- 2 Remove the bobbin from the bobbin case.
- 3 Place the bobbin in the bobbin case so that the thread unwinds in the correct direction.
  - Hold the bobbin with your right hand with the thread unwinding to the left, and hold the end of the thread with your left hand. Then, with your right hand, place the bobbin in the bobbin case.

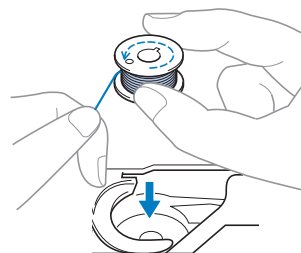

If the bobbin is inserted with the thread unwinding in the wrong direction, sewing will be done with an incorrect thread tension.

- 4 While holding the bobbin in place with your finger, pass the thread through the slit in the needle plate cover.

- Hold down the bobbin with your right hand, and then pull the end of the thread around the tab with your left hand.

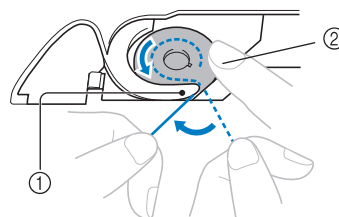

- ① Tab
- ② Hold down the bobbin with your right hand.

Pull the thread to pass it through the slit in the needle plate cover, then cut it with the cutter.

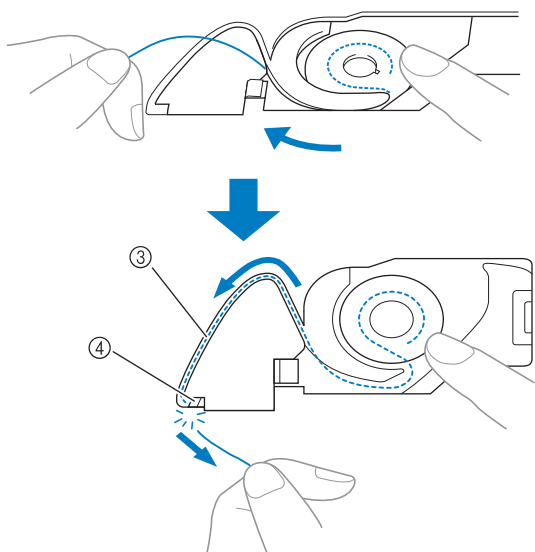

- ③ Slit
- ④ Cutter

Sewing with the correct thread tension is possible after the bobbin has been correctly installed in the bobbin case.

- 5 Press to unlock all keys and buttons.

## Tangled thread on wrong side of fabric

### Symptom

- The thread becomes tangled on the wrong side of the fabric.

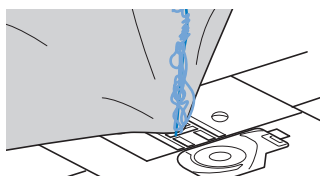

- After starting sewing, a rattling noise is made and sewing cannot continue.
- Looking under the fabric, there is tangled thread in the bobbin case.

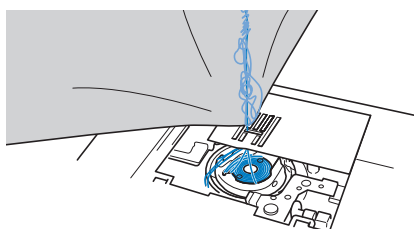

### Cause

#### Incorrect upper threading

If the upper thread is incorrectly threaded, the upper thread passed through the fabric cannot be firmly pulled up and the upper thread becomes tangled in the bobbin case, causing a rattling noise.

### Remedy/check details

Remove the tangled thread, and then correct the upper threading.

- 1 Remove the tangled thread. If it cannot be removed, cut the thread with scissors.
  - For details, refer to “Cleaning the race” on page A-2.
- 2 Remove the upper thread from the machine.
  - If the bobbin was removed from the bobbin case, refer to “Installing the bobbin” in the “Basic operations” section and “Remedy/check details” in the section “Upper thread tightened up” on page A-4 to correctly install the bobbin.
- 3 Refer to the following steps to correct the upper threading. Raise the presser foot using the presser foot lever.

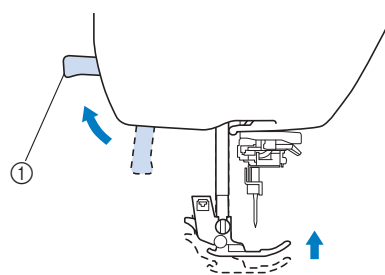

- ① Presser foot lever
  - The upper thread shutter opens so the machine can be threaded.
  - If the presser foot is not raised, the machine cannot be threaded correctly.

- 4 Press (Needle position button) once or twice to raise the needle.

→ The needle is correctly raised when the mark on the handwheel is at the top, as shown below. Check the handwheel and, if this mark is not at this position, press (Needle position button) until it is.

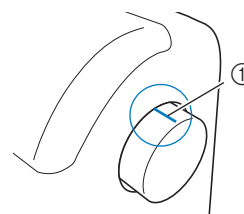

- ① Mark on handwheel

- 5 While holding the thread lightly with your right hand, pull the thread with your left hand, and then pass the thread behind the thread guide cover and to the front.

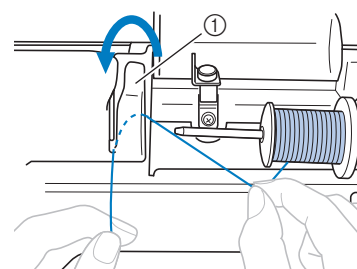

- ① Thread guide cover

- 6** Pass the thread under the thread guide plate, and then pull it up.

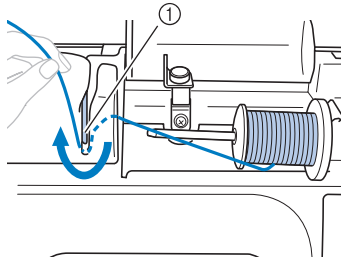

① Thread guide plate

- 7** While using your right hand to lightly hold the thread passed under the thread guide plate, pass the thread through the thread path in the order shown below.

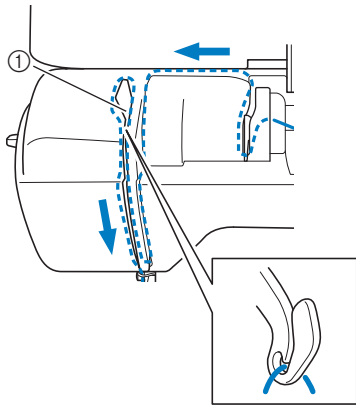

① Shutter

- 8** Lower the presser foot.

- 9** Press .

- 10** Slide the thread behind the needle bar thread guide. The thread can easily be passed behind the needle bar thread guide by holding the thread in your left hand, then feeding the thread with your right hand, as shown.

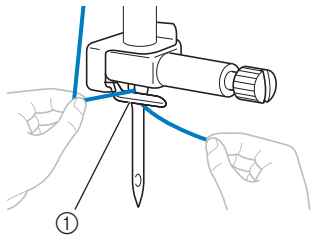

① Needle bar thread guide

- 11** Next, use the needle threader to thread the needle. Continue with the procedure in “Threading the needle” in the “Basic operations” section.

## Incorrect thread tension

### ■ Symptoms

- Symptom 1: The bobbin thread is visible from the right side of the fabric. (Refer to illustration below)
- Symptom 2: The upper thread appears as a straight line on the right side of the fabric.
- Symptom 3: The upper thread is visible from the wrong side of the fabric. (Refer to illustration below)
- Symptom 4: The bobbin thread appears as a straight line on the wrong side of the fabric.
- Symptom 5: The stitching on the wrong side of the fabric is loose or has slack.

#### □ Symptom 1

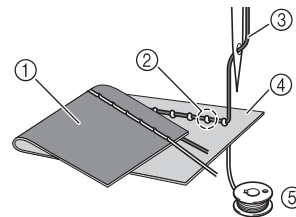

#### □ Symptom 3

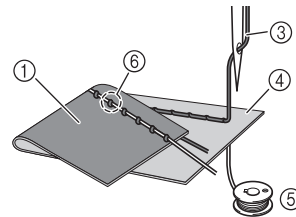

- ① Wrong side of fabric
- ② Bobbin thread visible from right side of fabric
- ③ Upper thread
- ④ Right side of fabric
- ⑤ Bobbin thread
- ⑥ Upper thread visible from wrong side of fabric

### ■ Cause/remedy/check details

#### □ Cause 1

##### The machine is not correctly threaded.

<With symptoms 1 and 2 described above>

The bobbin threading is incorrect.

Return the upper thread tension to the standard setting, and then refer to “Upper thread tightened up” on page A-4 to correct the threading.

<With symptoms 3 and 5 described above>

The upper threading is incorrect.

Return the upper thread tension to the standard setting, and then refer to “Tangled thread on wrong side of fabric” on page A-5 to correct the upper threading.

□ Cause 2

**A needle and thread appropriate for the fabric are not being used.**

The machine needle that should be used depends on the type of fabric sewn and the thread thickness.

If a needle and thread appropriate for the fabric are not being used, the thread tension will not be adjusted correctly, causing wrinkles in the fabric or skipped stitches.

- Refer to “Fabric/thread/needle combinations” in the “Basic operations” section to check that a needle and thread appropriate for the fabric are being used.

□ Cause 3

**An appropriate upper tension is not selected.**

The setting selected for the upper thread tension is not appropriate.

Refer to “Setting the thread tension” in the “Basic operations” section to select an appropriate thread tension.

The appropriate thread tension differs depending on the type of fabric and thread being used.

- \* Adjust the thread tension while test sewing on a piece of scrap fabric that is the same as that used in your project.



**Note**

- If the upper threading and bobbin threading are incorrect, the thread tension cannot be adjusted correctly. Check the upper threading and bobbin threading first, and then adjust the thread tension.

- If the bobbin thread is visible from the right side of the fabric  
**Using thread tension key (For models equipped with thread tension key. Refer to page B-8)**  
 Press “-” to decrease the tension of the upper thread.

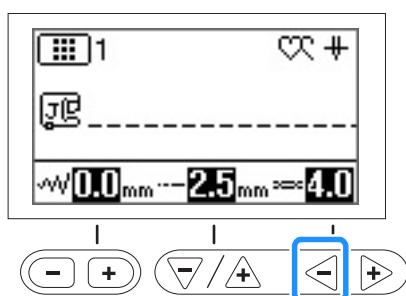

**Using thread tension dial (For models equipped with thread tension dial. Refer to page B-8)**

Turn the thread tension dial to the left to decrease the tension of the upper thread.

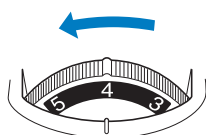

- If the upper thread is visible from the wrong side of the fabric  
**Using thread tension key (For models equipped with thread tension key. Refer to page B-8)**  
 Press “+” to increase the tension of the upper thread.

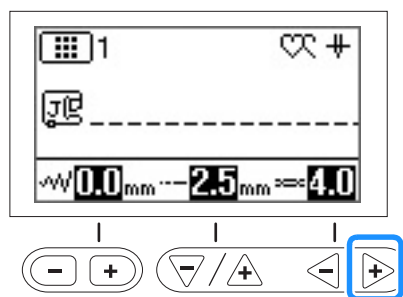

**Using thread tension dial (For models equipped with thread tension dial. Refer to page B-8)**

Turn the thread tension dial to the right to increase the tension of the upper thread.

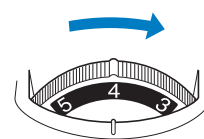



## Fabric is caught in the machine and cannot be removed

If the fabric is caught in the machine and cannot be removed, the thread may have become tangled under the needle plate. Follow the procedure described below to remove the fabric from the machine. If the operation could not be completed according to the procedure, instead of attempting to complete it forcefully, contact your nearest Brother authorized service center.

### ■ Removing the fabric from the machine

**1** Immediately stop the machine.

**2** Turn off the machine.

**3** Remove the needle.

If the needle is lowered into the fabric, turn the handwheel away from you (clockwise) to raise the needle out of the fabric, and then remove the needle.

- Refer to “Replacing the needle” in the “Basic operations” section.

**4** Remove the presser foot and presser foot holder.

- Refer to “Replacing the presser foot” and “Removing and attaching the presser foot holder” in the “Basic operations” section.

**5** Lift up the fabric and cut the threads below it.

If the fabric can be removed, remove it. Continue with the following steps to clean the race.

**6** Remove the needle plate cover.

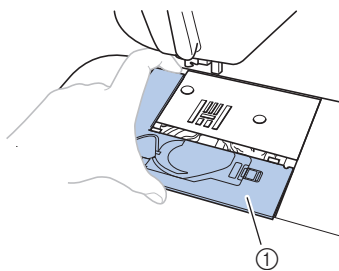

① Needle plate cover

- Refer to “Cleaning the race” on page A-2.

**7** Cut out the tangled threads, and then remove the bobbin.

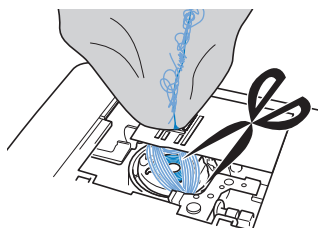

**8** Remove the bobbin case.

If threads remain in the bobbin case, remove them.

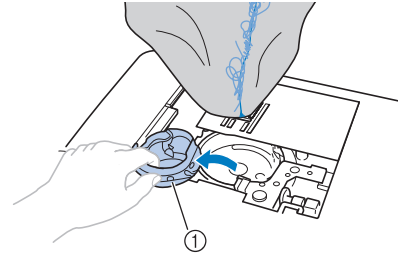

① Bobbin case

**9** Use the cleaning brush or a vacuum cleaner to remove any lint or dust from the race and its surrounding area.

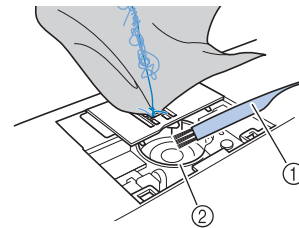

① Cleaning brush

② Race

If the fabric could be removed.	Continue with step <b>16</b> .
If the fabric could not be removed.	Continue with step <b>10</b> .

**10** Use the included L-shaped (or disc-shaped) screwdriver to loosen the two screws on the needle plate.

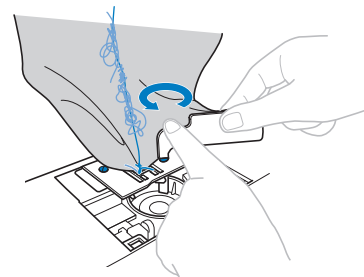

### Note

- Be careful not to drop the removed screws in the machine.

**11** Slightly lift up the needle plate, cut any tangled threads, and then remove the needle plate.

Remove the fabric and threads from the needle plate.

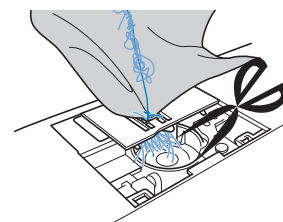

If the fabric cannot be removed, even after completing these steps, contact your nearest Brother authorized service center.

- 12 Remove any threads in the race and around the feed dogs.
- 13 Turn the handwheel to raise the feed dogs.
- 14 Align the two screw holes in the needle plate with the two holes at the needle plate mounting base, and then fit the needle plate onto the machine.
- 15 Lightly finger-tighten the screw on the right side of the needle plate. Then, use the L-shaped (or disc-shaped) screwdriver to firmly tighten the screw on the left side. Finally, firmly tighten the screw on the right side.

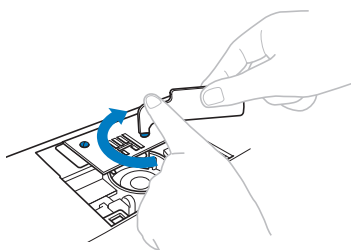

Turn the handwheel to check that the feed dogs move smoothly and do not contact the edges of the slots in the needle plate.

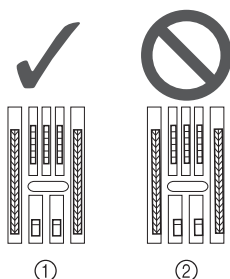

- ① Correct position of feed dogs
- ② Incorrect position of feed dogs



**Note**

- Be careful not to drop the removed screws in the machine.

- 16 Insert the bobbin case so that the ▲ mark on the bobbin case aligns with the ● mark on the machine.

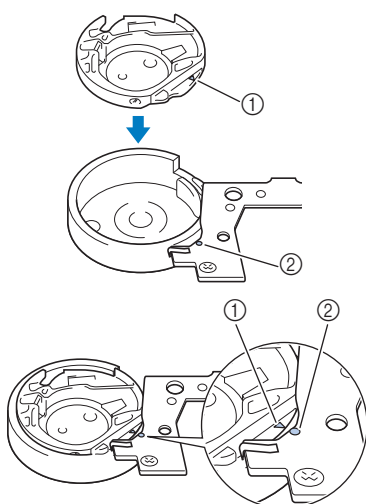

- Align the ▲ and ● marks.

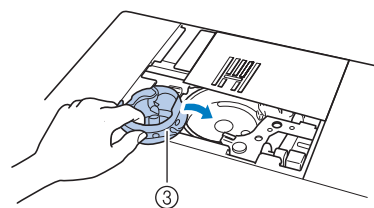

- ① ▲ mark
- ② ● mark
- ③ Bobbin case

- Make sure that the indicated points are aligned before installing the bobbin case.

**CAUTION**

- Never use a bobbin case that is scratched, otherwise the upper thread may become tangled, the needle may break or sewing performance may suffer.
- Make sure that you fit the bobbin case properly, otherwise the needle may break.

- 17 Attach the needle plate cover according to step 10 in “Cleaning the race” on page A-2.

- 18 Check the condition of the needle, and then install it.

If the needle is in a poor condition, for example, if it is bent, be sure to install a new needle.

- Refer to “Checking the needle” and “Replacing the needle” in the “Basic operations” section.

**CAUTION**

- Never use bent needles. Bent needles can easily break, possibly resulting in injuries.



**Note**

- After completing this procedure, continue with the following procedure in “Checking machine operations” to check that the machine is operating correctly.



**Memo**

- Since the needle may have been damaged when the fabric was caught in the machine, we recommend replacing it with a new one.

## ■ Checking machine operations

If the needle plate has been removed, check machine operations to confirm that installation has been completed correctly.

**1 Turn on the machine.**

**2 Select stitch** .



### Note

- Do not yet install the presser foot and thread.

**3 Slowly turn the handwheel toward you (counterclockwise), and look from all sides to check that the needle falls at the center of the opening in the needle plate.**

If the needle contacts the needle plate, remove the needle plate, and then install it again, starting with step **13** in “Removing the fabric from the machine” on page A-8.

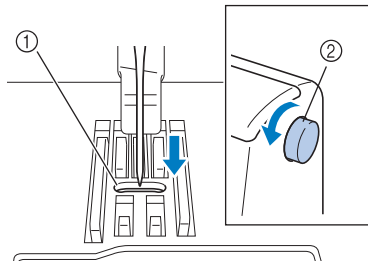

- ① Opening in the needle plate
- ② Handwheel

**4 Select stitch** . **At this time, increase the stitch length and width to their maximum settings.**

- For details on changing the settings, refer to “Setting the stitch width” and “Setting the stitch length” in the “Basic operations” section.

**5 Slowly turn the handwheel toward you (counterclockwise) and check that the needle bar and feed dogs operate correctly.**

If the needle or feed dogs contact the needle plate, the machine may be malfunctioning; therefore, contact your nearest Brother authorized service center.

**6 Turn off the machine, and then install the bobbin and presser foot.**

- Refer to “Installing the bobbin” and “Replacing the presser foot” in the “Basic operations” section.

**7 Correctly thread the machine.**

- For details on threading the machine, refer to “Upper Threading” in the “Basic operations” section.



### Memo

- The thread may have become tangled as a result of incorrect upper threading. Make sure that the machine is correctly threaded.

**8 Perform trial sewing with cotton fabric.**



### Note

- Incorrect sewing may be the result of incorrect upper threading or sewing thin fabrics. If there are poor results from the trial sewing, check the upper threading or the type of fabric being used.

## When the thread became tangled under the bobbin winder seat

If the bobbin winding starts when the thread is not passed under the pretension disk of the bobbin-winding thread guide correctly, the thread may become tangled under the bobbin winder seat.

In such a case, wind off the thread according to the following procedure.

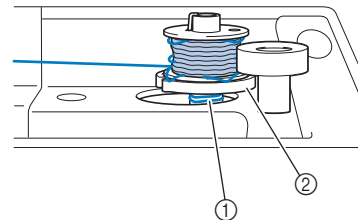

- ① Thread
- ② Bobbin winder seat

## ⚠ CAUTION

- Do not remove the bobbin winder seat even if the thread become tangled under the bobbin winder seat. It may result in injuries.
- Do not remove the screw on the bobbin winder guide post, otherwise the machine may be damaged; you cannot wind off the thread by removing the screw.

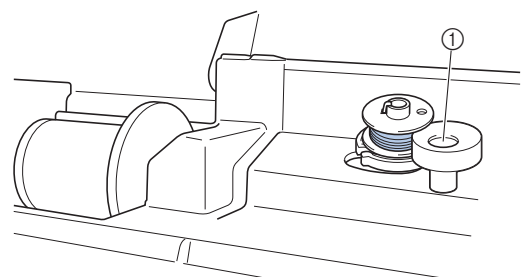

- ① Screw of the bobbin winder guide post

- 1 If the thread become tangled under the bobbin winder seat, press the “Start/Stop” button once to stop the bobbin winding.  
When the foot controller is plugged in, remove your foot from the foot controller.
- 2 Cut the thread with scissors beside the bobbin-winding thread guide.

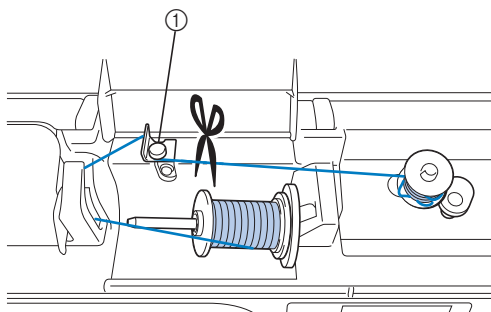

① Bobbin-winding thread guide

- 3 Slide the bobbin winder shaft to the left, and then remove the bobbin from the shaft and cut the thread leading to the bobbin in order to be able to completely remove the bobbin from shaft.

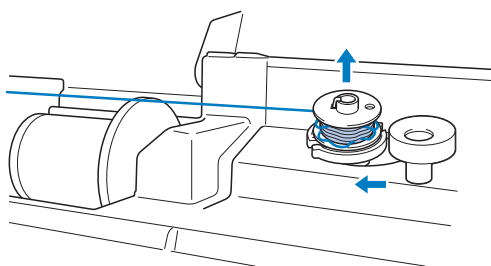

- 4 Hold the thread end with your left hand, and wind off the thread clockwise with your right hand as shown below.

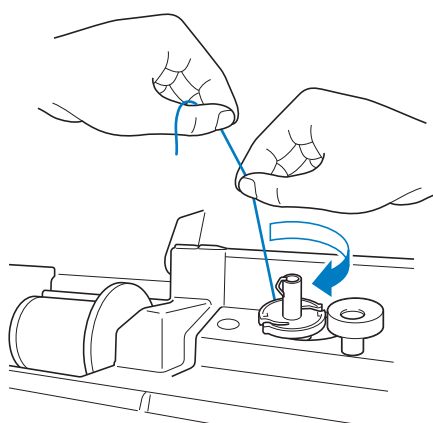

- 5 Wind the bobbin again.



**Note**

- Make sure that the thread passes under the pretension disk of the bobbin-winding thread guide correctly.

## List of symptoms

### ■ Getting ready

Symptom	Probable Cause	Remedy	Reference
<b>Cannot thread the needle.</b>	Needle is not in the correct position.	Press the "Needle position" button to raise the needle.	B-3
	Needle is installed incorrectly.	Reinstall the needle correctly.	B-29
	Needle is turned, bent or the point is dull.	Replace the needle.	B-29
	Upper threading is incorrect.	Check the steps for threading the machine and rethread the machine.	B-21
	The needle threader hook is bent and does not pass through the eye of the needle.	Contact your authorized Brother dealer or the nearest Brother authorized service center.	–
	The needle threader lever cannot be moved or returned to its original position.	Contact your authorized Brother dealer or the nearest Brother authorized service center.	–
	A size 65/9 needle is being used.	The needle is incompatible with the needle threader. Manually pass the thread through the eye of the needle.	B-24
<b>Cannot lower the presser foot with the presser foot lever. (For models equipped with the presser foot lifter button)</b>	Presser foot was raised using the "Presser foot lifter" button.	Press the "Presser foot lifter" button to lower the presser foot.	B-3
<b>Bobbin thread does not wind neatly on the bobbin.</b>	The thread is not passed through the bobbin winding thread guide correctly.	Correctly pass the thread through the bobbin winding thread guide.	B-15
	Bobbin spins slowly.	Move the sewing speed controller to the right so that the speed will be increased.	B-15
	The thread that was pulled out was not wound onto the bobbin correctly.	Wind the thread that was pulled off around the bobbin 5 or 6 times clockwise.	B-15
	The empty bobbin was not set on the pin properly.	Set the empty bobbin on the pin and slowly turn the bobbin until you hear it click in place.	B-15
<b>While winding the bobbin, the bobbin thread was wound below the bobbin winder seat.</b>	You have not wound the bobbin thread properly. While initially winding thread on the bobbin the bobbin thread is not properly inserted into the guides.	After removing the thread wound below the bobbin winder seat, wind the bobbin correctly. Follow the drawn images on the top of the machine for guidance when threading the machine for bobbin winding.	B-15, A-10
<b>The bobbin thread cannot be pulled up.</b>	Needle is turned, bent or the point is dull.	Replace the needle.	B-29
	Bobbin is set incorrectly.	Reset the bobbin correctly.	B-18
<b>Nothing appears in the LCD.</b>	Main power switch is not turned on.	Turn the main power to ON.	B-10
	The plug of the power cord is not inserted into an electrical outlet.	Insert the plug of the power cord into an electrical outlet.	B-10
	The brightness of the LCD is either too light or too dark.	Adjust the brightness of the LCD.	A-20
<b>The LCD screen is fogged up.</b>	Condensation has formed on the LCD screen.	After a while, the cloudiness will disappear.	–
<b>The operation keys do not respond.</b>	A glove is worn when the keys are pressed. The keys are pressed with a fingernail. A non-electrostatic touch pen is being used.	Directly touch the operation keys with your finger.	B-4

Symptom	Probable Cause	Remedy	Reference
<b>The operation keys do not respond, or the sensitivity is too strong.</b>	The sensitivity of the operation keys is not set for the user.	Adjust the sensitivity of the operation keys.	B-14
<b>The sewing light does not come on.</b>	The sewing light is damaged.	Contact your authorized Brother dealer or the nearest Brother authorized service center.	–
	 (Light) is set to “OFF” in the settings screen.	Change the setting to “ON”.	B-12

■ While sewing

Symptom	Probable Cause	Remedy	Reference
<b>Machine does not operate.</b>	“Start/Stop” button was not pressed.	Press the “Start/Stop” button.	B-35
	The bobbin winder shaft is pushed to the right.	Move the bobbin winder shaft to the left.	B-15
	There is no pattern selected.	Select a pattern.	B-34
	Presser foot is not lowered.	Lower the presser foot.	B-35
	“Start/Stop” button was pushed with the foot controller attached.	Remove the foot controller, or use the foot controller to operate the machine.	B-36
	The “Start/Stop” button was pressed while the machine is set for the sewing speed controller to control the zigzag stitch width.	Use the foot controller instead of the “Start/Stop” button to operate the machine, or set the  (Width control) to “OFF” in the settings screen.	B-12
<b>Needle breaks.</b>	Needle is installed incorrectly.	Reinstall the needle correctly.	B-29
	Needle clamp screw is not tightened.	Tighten the needle clamp screw.	B-29
	Needle is turned or bent.	Replace the needle.	B-29
	Using improper needle or thread for the selected fabric.	Check the “Fabric/Thread/Needle Combinations” chart.	B-28
	Wrong presser foot was used.	Use the recommended presser foot.	B-32
	Upper thread tension is too tight.	Adjust the thread tension setting.	B-40
	Fabric is pulled during sewing.	Do not pull the fabric during sewing.	–
	Spool cap is set incorrectly.	Check the method for attaching the spool cap, then reattach the spool cap.	B-15
	There are scratches around the opening in the needle plate.	Replace the needle plate, or consult your authorized Brother dealer.	A-8
	There are scratches around the opening in the presser foot.	Replace the presser foot, or consult your authorized Brother dealer.	B-31
	There are scratches on the bobbin case.	Replace the bobbin case, or consult your authorized Brother dealer.	A-2
	Needle is defective.	Replace the needle.	B-29
	A bobbin designed specifically for this machine is not used.	Incorrect bobbins will not work properly. Only use a bobbin designed specifically for this machine.	B-15
	Upper threading is incorrect.	Check the steps for threading the machine and rethread the machine.	B-21
	Bobbin is set incorrectly.	Reset the bobbin thread correctly.	B-18
Presser foot is attached incorrectly.	Attach the presser foot correctly.	B-31	



Symptom	Probable Cause	Remedy	Reference
<b>Needle breaks.</b>	Screw of the presser foot holder is loose.	Securely tighten the screw of the presser foot.	B-32
	Fabric is too thick.	Use fabric that the needle can pierce when the handwheel is turned.	B-28, S-4
	Fabric is fed forcefully when sewing thick fabric or thick seams.	Allow the fabric to be fed without being forcefully pushed.	S-4
	Stitch length is too short.	Adjust the stitch length.	B-39
	Bobbin thread is incorrectly wound.	Use a correctly wound bobbin.	B-15
<b>Upper thread breaks.</b>	Machine is not threaded correctly (used the wrong spool cap, spool cap is loose, the thread did not catch the needle bar threader, etc.)	Rethread the machine correctly.	B-21
	Knotted or tangled thread is being used.	Remove any knots or tangles.	–
	The selected needle is not appropriate for the thread being used.	Select a needle that is appropriate for the type of thread being used.	B-28
	Upper thread tension is too tight.	Adjust the thread tension.	B-40
	Thread is tangled.	Use scissors, etc., to cut the tangled thread and remove it from the race, etc.	A-5
	Needle is turned, bent or the point is dull.	Replace the needle.	B-29
	Needle is installed incorrectly.	Reinstall the needle correctly.	B-29
	There are scratches around the opening in the needle plate.	Replace the needle plate, or consult your authorized Brother dealer.	A-8
	There are scratches around the opening in the presser foot.	Replace the presser foot, or consult your authorized Brother dealer.	B-31
	There are scratches on the bobbin case.	Replace the bobbin case, or consult your authorized Brother dealer.	A-2
	Using improper needle or thread for the selected fabric.	Check the “Fabric/Thread/Needle Combinations” chart.	B-28
	While sewing, the thread became knotted or tangled.	Rethread upper and lower thread.	B-15, B-21
	A bobbin designed specifically for this machine is not used.	Incorrect bobbins will not work properly. Only use a bobbin designed specifically for this machine.	B-15
<b>The thread is tangled on the wrong side of the fabric.</b>	Upper threading is incorrect.	Check the steps for threading the machine and rethread the machine. Be sure that the presser foot is in the raised position when threading the machine so that the upper thread sets properly in the upper tension.	B-21, A-5
	Using improper needle or thread for the selected fabric.	Check the “Fabric/Thread/Needle Combinations” chart.	B-28
<b>The upper thread is too tight.</b>	The bobbin thread is incorrectly installed.	Correctly install the bobbin thread.	B-18, A-4
<b>Bobbin thread breaks.</b>	Bobbin is set incorrectly.	Reset the bobbin correctly.	B-18
	Bobbin thread is incorrectly wound.	Use a correctly wound bobbin.	B-15
	There are scratches on the bobbin or it doesn't rotate properly.	Replace the bobbin.	B-18
	Thread is tangled.	Use scissors, etc. to cut the tangled thread and remove it from the race, etc.	A-8
	A bobbin designed specifically for this machine is not used.	Incorrect bobbins will not work properly. Only use a bobbin designed specifically for this machine.	B-15

Symptom	Probable Cause	Remedy	Reference
<b>Fabric puckers.</b>	There is a mistake in the upper or bobbin threading.	Check the steps for threading the machine and rethread it correctly.	B-21
	Spool cap is set incorrectly.	Check the method for attaching the spool cap, then reattach the spool cap.	B-21
	Using improper needle or thread for the selected fabric.	Check the “Fabric/Thread/Needle Combination” chart.	B-28
	Needle is turned, bent or the point is dull.	Replace the needle.	B-29
	Stitches are too long when sewing thin fabrics.	Shorten the stitch length.	B-39
	Thread tension is set incorrectly.	Adjust the thread tension.	B-40
	Wrong presser foot.	Use the correct presser foot.	B-32
<b>Skipped stitches</b>	Machine is threaded incorrectly.	Check the steps for threading the machine and rethread it correctly.	B-21
	Using improper needle or thread for the selected fabric.	Check the “Fabric/Thread/Needle Combination” chart.	B-28
	Needle is turned, bent or the point is dull.	Replace the needle.	B-29
	Needle is installed incorrectly.	Reinstall the needle correctly.	B-29
	The needle is worn/damaged.	Replace the needle.	B-29
	Dust or lint has collected under the needle plate.	Remove the dust or lint with the brush.	A-2
	Thin or stretch fabrics are being sewn.	Sew with one sheet of thin paper under the fabric.	S-4, D-3
<b>No stitching</b>	Needle is turned, bent or the point is dull.	Replace the needle.	B-29
	Bobbin is set incorrectly.	Reset the bobbin thread correctly.	B-18
	Upper threading is incorrect.	Check the steps for threading the machine and rethread the machine.	B-21
<b>High-pitched sound while sewing</b>	Dust or lint is caught in the feed dogs.	Remove the dust or lint.	A-2
	Pieces of thread are caught in the race.	Clean the race.	A-2
	Upper threading is incorrect.	Check the steps for threading the machine and rethread the machine.	B-21
	A bobbin designed specifically for this machine is not used.	Incorrect bobbins will not work properly. Only use a bobbin designed specifically for this machine.	B-15
	There are needle holes or friction scratches in the bobbin case.	Replace the bobbin case, or consult your authorized Brother dealer.	A-2
<b>Fabric does not feed through the machine.</b>	Feed dogs are set in the down position.	Slide the feed dog position switch to the right 	B-2
	Stitches are too close together.	Lengthen the stitch length setting.	B-39
	Wrong presser foot was used.	Use the correct presser foot.	B-32
	Needle is turned, bent or the point is dull.	Replace the needle.	B-29
	Thread is entangled.	Cut the entangled thread and remove it from the race.	A-8
	Zigzag foot “J” is slanted on a thick seam at the beginning of stitching.	Use the presser foot locking pin (black button on the left side) on zigzag foot “J” to keep the presser foot level while sewing.	S-4
	Presser foot pressure is set incorrectly for fabric.	Adjust the presser foot pressure within the settings screen.	B-43







Symptom	Probable Cause	Remedy	Reference
<b>The fabric feeds in the opposite direction.</b>	The feed mechanism is damaged.	Contact your authorized Brother dealer or the nearest Brother authorized service center.	–
<b>The needle contacts the needle plate.</b>	The needle clamp screw is loose.	Firmly tighten the needle clamp screw. If the needle is bent or blunt, replace it with a new one.	B-29
	Needle is turned, bent or the point is dull.	Replace the needle.	B-29
<b>Fabric being sewn with the machine cannot be removed.</b>	Thread is tangled below the needle plate.	Lift up the fabric and cut the threads below it, and clean the race.	A-8
<b>A broken needle has fallen into the machine.</b>	–	Turn off the machine, and then remove the needle plate. If the needle that fell into the machine can be seen, use tweezers to remove it. After removing the needle, return the needle plate to its original position and insert a new needle. Before turning on the machine, slowly turn the handwheel toward you to check that it turns smoothly and that the new needle enters through the center of the needle plate opening. If the handwheel does not turn smoothly or the needle that fell into the machine cannot be removed, contact your authorized Brother dealer or the nearest Brother authorized service center.	A-8
<b>The handwheel feels sluggish when it is turned.</b>	Thread is tangled in the bobbin case.	Remove the tangled thread from the bobbin case. Re-install the bobbin case so it is correctly positioned.	A-5, A-8
<b>The stitch is not sewn correctly.</b>	The presser foot that is used is not appropriate for the type of stitch that you wish to sew.	Attach the presser foot that is appropriate for the type of stitch that you wish to sew.	B-32
	The thread tension is incorrect.	Adjust the tension of the upper thread.	B-40, A-6
	The thread is tangled, for example, in the bobbin case.	Remove the tangle thread. If the thread is tangled in the bobbin case, clean the race.	A-8
	Feed dogs are set in the down position.	Slide the feed dog position switch to the right ▲▲▲.	B-2





■ After sewing









Symptom	Probable Cause	Remedy	Reference
<b>Thread tension is incorrect.</b>	Upper threading is incorrect.	Check the steps for threading the machine and rethread the machine.	B-21
	Bobbin is set incorrectly.	Reset the bobbin. (If needle plate was removed, reinstall needle plate and tighten screws prior to installing bobbin case. Check to make sure needle enter through the center of needle plate opening.)	B-18, A-2
	Using improper needle or thread for the selected fabric.	Check the "Fabric/Thread/Needle Combinations" chart.	B-28
	Presser foot holder is not attached correctly.	Reattach the presser foot holder correctly.	B-32
	Thread tension is set incorrectly.	Adjust the thread tension.	B-40, A-6
	Bobbin thread is incorrectly wound.	Use a correctly wound bobbin.	B-15
	Needle is turned, bent or the point is dull.	Replace the needle.	B-29
A bobbin designed specifically for this machine is not used.	Incorrect bobbins will not work properly. Only use a bobbin designed specifically for this machine.	B-15	
<b>Character or decorative patterns are misaligned.</b>	Pattern adjustment settings were set incorrectly.	Revise the pattern adjustment settings.	D-10
<b>Pattern does not turn out.</b>	Wrong presser foot was used.	Attach the correct presser foot.	B-32
	Did not use a stabilizer material on thin fabrics or stretch fabrics.	Attach a stabilizer material.	S-4, D-3
	Thread tension is set incorrectly.	Adjust the thread tension.	B-40, A-6
	Fabric was pulled, pushed or fed at an angle while it was being sewn.	Sew while guiding the fabric with your hands so that the fabric is fed in a straight line.	B-35
	The thread is tangled, for example, in the bobbin case.	Remove the tangle thread. If the thread is tangled in the bobbin case, clean the race.	A-8





**Error messages**

If the "Start/Stop" button is pressed before the machine is correctly set up or if an operation is performed incorrectly, an error message appears in the LCD. Follow the instructions that appear. The message will disappear if  or  is pressed while the message is displayed.

	Error Messages	Cause/Solution
1	 Change the speed controller mode to "OFF".	This message is displayed when the sewing speed controller is set to control the zigzag stitch width, and the "Start/Stop" button is pressed. Set  (Width control) to "OFF" (refer to page B-12), or use the foot controller to operate the machine.
2	 Change to the single needle mode, and replace the needle.	This message is displayed when  (Twin needle) is set to "ON", and a stitch pattern that cannot be sewn with the twin needle is selected.

	Error Messages	Cause/Solution
3	 Disconnect the foot controller.	This message is displayed when the “Start/Stop” button was pressed while the foot controller was connected.
4	 Lift the buttonhole lever.	This message is displayed when the buttonhole lever is down, a stitch other than a buttonhole is selected, and a button, such as the “Start/Stop” button, is pressed.
5	 Lower the buttonhole lever.	This message is displayed when the buttonhole lever is up, a buttonhole stitch is selected, and a button, such as the “Start/Stop” button, is pressed.
6	 Lower the presser foot lever.	This message is displayed when a button, such as the “Start/Stop” button, was pressed while the presser foot was raised.
7	 No more stitches can be combined.	This message is displayed when you tried to combine more than 70 decorative stitches.
8	 OK to cancel the current pattern selection?	This message is displayed when the stitch mode was changed.
9	 OK to delete the selected pattern?	This message is displayed when you tried to delete a saved pattern.
10	 Return the bobbin winding shaft to left.	This message is displayed when a button, such as the Reverse/reinforcement stitch button, was pressed while the bobbin winder shaft is moved to the right.
11	 Select a pattern.	This message is displayed when a button, such as the “Start/Stop” button, was pressed after a stitch has been deleted.

	Error Messages	Cause/Solution
12	 <p>The safety device has been activated.</p>	<p>This message is displayed when the motor locks due to tangled thread or for other reasons related to thread delivery.</p>
13	 <p>Turn off the power and replace the needle plate.</p>	<p>This message is displayed when you try to sew with a stitch other than a straight stitch (middle needle position) while the straight stitch needle plate is installed. This message is also displayed when the needle plate is removed while the machine is still turned on.</p>
14	F**	<p>If error message “F**” appears in the LCD while the machine is being used, the machine may be malfunctioning. Contact your nearest Brother authorized service center.</p>



## Operation beep

Each time a key is pressed you will hear one beep. If an incorrect operation is performed you will hear two or four beeps.

- **If a key is pressed (correct operation)**  
One beep sounds.
- **If an incorrect operation is performed**  
Two or four beeps sound.
- **If the machine locks up, for example, because the thread is tangled**  
The machine beeps for four seconds and the machine automatically stops.  
Be sure to check for the cause of the error and correct it before continuing to sew.
- **Canceling the operation beep**

- 1 Select  (Buzzer) in the settings screen and set it to "OFF".



## Nothing appears in the LCD

If nothing appears in the LCD when the machine is turned on, the brightness of the LCD is either too light or too dark. If this is the case, perform the following operation.

- 1 Turn off the machine.
- 2 While pressing  (Reinforcement stitch button) on the operation panel, turn on the sewing machine.
- 3 Press the "-" or "+" key.  
Adjust the brightness of the LCD so that the screens can be seen.

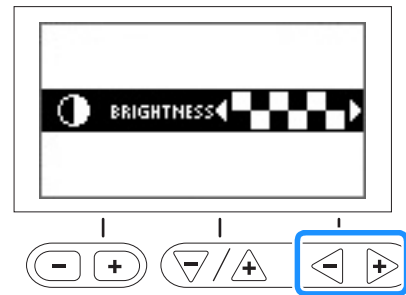

- 4 Turn off the machine, then turn it on again.

## Specifications

Item	Specification
Dimensions of machine	Approx. 480 mm (W) x 300 mm (H) x 249.4 mm (D) (Approx. 18-7/8 inches (W) x 11-7/8 inches (H) x 9-7/8 inches (D))
Weight of machine	Approx. 9.7 kg (Approx. 21.3 lb)
Sewing speed	70 to 850 stitches per minute
Needles	Home sewing machine needles (HA x 130)

\* Please be aware that some specifications may change without notice.

## Index

## Numerics

1/4" quilting foot .....	S-28
1/4" quilting foot with guide .....	S-28
7 mm satin stitches .....	D-2

## A

Accessories	
included accessories .....	B-6
optional accessories .....	B-7
Accessory compartment .....	B-5
Adjustable zipper/piping foot .....	S-23
Adjusting stitch length .....	B-39
Adjusting stitch width .....	B-39
Adjusting thread tension .....	B-40
Air vent .....	B-2
Appliqué .....	S-26
Attaching presser foot holder .....	B-32
Automatic fabric sensor system .....	B-43
Automatic reinforcement stitch key .....	B-37
Automatic thread cutting .....	B-42

## B

Ball point needle .....	B-28
Bar tack stitch .....	S-35
Basic sewing .....	B-33, D-4
Basic stitching .....	S-6
Basting stitch .....	S-6
Beep .....	A-20
Blind hem stitch .....	S-8
Bobbin case .....	B-3
bobbin case removal .....	A-2
Bobbin cover .....	B-3, B-18
Bobbin installation .....	B-18
Bobbin thread	
pulling up .....	B-24
winding .....	B-15
Bobbin winder .....	B-2
Bobbin winding .....	B-15
Bobbin winding thread guide .....	B-2, B-15
Button guide plate .....	S-15
Button sewing .....	S-17
Buttonhole lever .....	B-3, S-15
Buttonhole sewing .....	S-14
Buttonhole stitching .....	S-14
Buzzer .....	A-20

## C

Changing sewing direction .....	S-2
Character spacing .....	D-7
Character stitches .....	B-34, D-2
Checking needle .....	B-29
Cleaning	
cleaning machine surface .....	A-2
LCD screen .....	A-2
race .....	A-2
Combining patterns .....	D-5
Concealed seams .....	S-19
Crazy quilt stitching .....	S-27
Cross stitch stitches .....	D-2
Curve sewing .....	S-2
Custom stitches .....	D-12
Cutting thread automatically .....	B-42
Cylindrical pieces .....	S-2

## D

Darning .....	S-36
Darning stitch .....	S-35
Decorative stitches & patterns .....	D-2
Design examples .....	D-14
Designing stitch patterns .....	D-12
Drawnwork .....	S-44

## E

Error messages .....	A-17
Even seam allowance .....	S-3
Examples of designs .....	D-14
Eyelet stitching .....	S-38

## F

Fagoting .....	S-41
Feed dog position switch .....	B-2
Feed dogs .....	B-3
Flat bed attachment .....	B-2, B-5
Foot controller .....	B-2, B-36
Foot controller jack .....	B-2, B-36
Fraying, preventing .....	S-11
Free motion mode .....	B-44
Free motion quilting .....	S-30
free motion echo quilting foot "E" .....	S-32
free motion open toe quilting foot "O" .....	S-30
free motion quilting foot "C" .....	S-31
Front view .....	B-2

## H

Handle .....	B-2
Handwheel .....	B-2
Heirloom stitching .....	S-44
Horizontal spool pin .....	B-25
Horizontal stitching .....	S-39

## I

Inserting a piping .....	S-24
Installing bobbin .....	B-18

## J

Joining .....	S-43
---------------	------

## K

Knee lifter .....	B-45
Knee lifter mounting slot .....	B-2, B-45

## L

LCD	
nothing appears .....	A-20
LCD messages .....	A-17
LCD operation .....	B-11
LCD screen	
cleaning .....	A-2
Leather/vinyl fabrics .....	S-5

## M

Machine surface cleaning .....	A-2
Main power switch .....	B-2, B-10
Maintenance .....	A-2

## A

Manual needle threading ..... B-24  
 Mirroring ..... B-42, D-8  
 Mirroring stitches ..... B-42  
 MY CUSTOM STITCH ..... D-12

**N**

Needle  
     condition ..... B-29  
     position ..... S-7  
     replacement ..... B-29  
     threading ..... B-23  
     types, sizes & uses ..... B-28  
 Needle bar thread guide ..... B-3  
 Needle plate ..... B-3  
 Needle plate cover ..... B-3  
 Needle plate marking ..... S-3  
 Needle position button ..... B-3  
 Needle threader ..... B-23  
 Needle threader lever ..... B-2, B-23  
 Non stick foot ..... S-5

**O**

Operation beep ..... A-20  
 Operation buttons ..... B-3  
 Operation keys ..... B-4  
 Operation panel ..... B-2, B-4  
 Operation problems ..... A-4  
 Optional accessories ..... B-7  
 Overcasting stitches ..... S-11, S-12

**P**

Pant legs ..... S-2  
 Parallel stitches ..... B-25  
 Part names & functions ..... B-2  
 Patchwork ..... S-26, S-27  
 Pattern  
     check ..... D-6  
     combination ..... D-5  
     density ..... D-6  
     length ..... D-7  
     mirroring ..... D-8  
     realignment ..... D-10  
     recalling ..... D-10  
     repetition ..... D-5  
     size ..... D-6  
     storage ..... D-9  
 Piecing ..... S-27  
 Piping inserting ..... S-24  
 Pivoting ..... B-43  
 Power supply jack ..... B-2, B-10  
 Power switch ..... B-2, B-10  
 Presser foot  
     pressure ..... B-43  
     replacement ..... B-31  
     types ..... B-46  
 Presser foot holder  
     installation ..... B-32  
     removal ..... B-32  
 Presser foot holder screw ..... B-3  
 Presser foot lever ..... B-2  
 Presser foot lifter button ..... B-3  
 Pretension disk ..... B-2, B-17, A-10

**Q**

Quilting ..... S-29  
 Quilting guide ..... S-30

**R**

Race ..... A-2

Realigning pattern ..... D-10  
 Recalling pattern ..... D-10  
 Reinforcement stitch button ..... B-3, B-37  
 Reinforcement stitching ..... S-35  
 Removing presser foot holder ..... B-32  
 Repeating patterns ..... D-5  
 Replacing needle ..... B-29  
 Replacing presser foot ..... B-31  
 Reverse stitch button ..... B-3, B-37  
 Reverse/Reinforcement stitches ..... B-37

**S**

Satin stitch length, changing ..... D-7  
 Satin stitches ..... D-2  
 Satin stitching ..... S-34  
 Saving stitch settings ..... B-41  
 Scallop stitching ..... S-42  
 Seam allowance, even ..... S-3  
 Seam ripper ..... S-16  
 Settings  
     automatic reinforcement stitching ..... B-37  
     display language ..... B-14  
     input sensitivity ..... B-14  
 Settings screen ..... B-12  
 Sewing basics ..... B-33  
 Sewing direction change ..... S-2  
 Sewing speed controller ..... B-3, S-34  
 Shell tuck stitch ..... S-43  
 Side cutter ..... S-12  
 Size ..... D-6  
 Smocking ..... S-42  
 Solving operation problems ..... A-4  
 Spool cap ..... B-2, B-16  
 Spool net ..... B-16  
 Spool pin ..... B-2, B-15, B-21  
 "Start/Stop" button ..... B-3  
 Step stitch pattern ..... D-7  
 Stippling ..... S-26  
 Stitch guide foot ..... S-3  
 Stitch length adjustment ..... B-39  
 Stitch selection ..... B-34  
 Stitch settings ..... B-46  
 Stitch types ..... B-33  
 Stitch width adjustment ..... B-39  
 Storing patterns ..... D-9  
 Straight stitch ..... S-6, S-19, S-27  
 Stretch fabrics ..... S-5

**T**

Thick fabrics ..... S-4  
 Thin fabrics ..... S-4  
 Thread cutter ..... B-2, B-36  
 Thread cutter button ..... B-3  
 Thread cutting, automatic ..... B-42  
 Thread guide plate ..... B-2  
 Thread tension adjustment ..... B-40  
 Thread tension dial ..... B-2, B-40, A-7  
 Threading  
     threading needle ..... B-23  
     threading needle manually ..... B-24  
     upper threading ..... B-21  
 Tips ..... S-2  
 Top cover ..... B-2  
 Trial sewing ..... S-2  
 Triple stretch stitch ..... S-6, S-35  
 Troubleshooting ..... A-4  
 Twin needle ..... B-25

**U**

Upper thread ..... B-21  
 Upper thread tension ..... B-40, A-6

Utility stitches ..... B-34, B-46

## W

Winding bobbin ..... B-15

Wing needle ..... S-44

## Z

Zigzag stitches ..... S-12, S-26

Zigzag width adjustment ..... B-39

Zipper insertion

    centered ..... S-19, S-23

    side ..... S-20

# A

## MAINTENANCE AND TROUBLESHOOTING



Please visit us at <http://support.brother.com/> where you can get product support and answers to frequently asked questions (FAQs).

English  
888-F50/F52/F60/F62/F70/F72  
Printed in Vietnam



XF9995-201②