



View this machine and more at:

<https://www.thesewingstudio.co.uk>

Quick Reference Guide

Hurtigguide

Snabbstartsguide

Quickguide

Pikaopas

Stručná referenční příručka

Gyors útmutató

Skrócona instrukcja obsługi

РЪКОВОДСТВО за бързи справки

Ghid de referință rapidă

Be sure to read this document before using the machine.
We recommend that you keep this document nearby for future reference.

Sørg for å lese dette dokumentet før du bruker maskinen.
Vi anbefaler at du oppbevarer dette dokumentet i nærheten for fremtidig referanse.

Läs det här dokumentet innan du använder maskinen.
Vi rekommenderar att du sparar dokumentet för framtida referens.

Sørg for at læse dette dokument, inden du bruger maskinen.
Vi anbefaler, at du gemmer dette dokument, så det er ved hånden til fremtidig brug.

Muista lukea tämä pikaopas ennen koneen käyttöä.
Suosittelemme tämän pikaoppaan säilyttämistä koneen läheisyydessä myöhempää käyttöä varten.

Před použitím stroje si přečtěte tento dokument.
Doporučujeme tento dokument uchovávat v blízkosti stroje, aby byl k dispozici k nahlédnutí.

A gép használatba vétele előtt feltétlenül olvassa el ezt a dokumentumot.
Javasoljuk, hogy tartsa ezt a dokumentumot a gép közelében, hogy szükség esetén kéznél legyen.

Przed przystąpieniem do używania maszyny zapoznaj się z niniejszym dokumentem.
Zalecamy zachowanie tego dokumentu na przyszłość i przechowywanie go w dostępnym miejscu.

Непременно прочетете този документ, преди да използвате машината.
Препоръчваме ви да съхранявате този документ наблизо за бъдещи справки.

Citiți acest document înainte de a utiliza mașina.
Vă recomandăm să păstrați acest document la îndemână pentru consultare ulterioară.

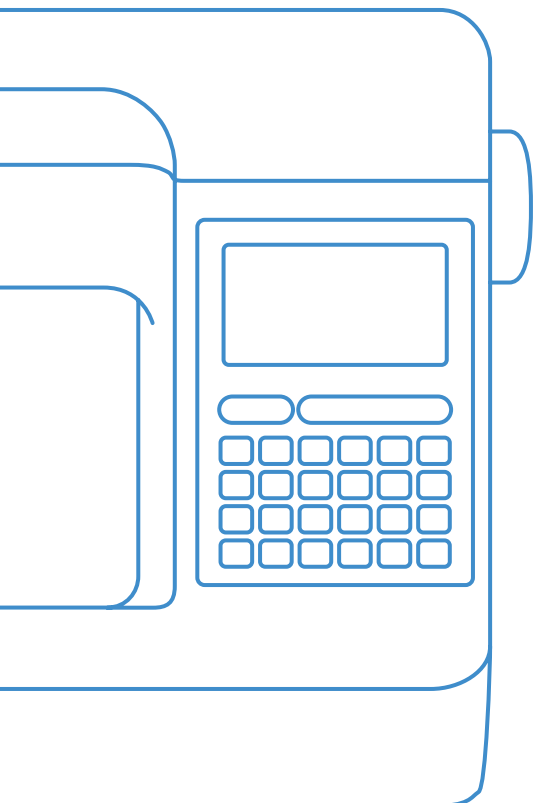

Before using your machine for the first time please read the “IMPORTANT SAFETY INSTRUCTIONS” in the Operation Manual.

Refer to the Operation Manual for detailed instructions. In this guide, English screens are used for basic explanations.

Innan du använder maskinen första gången bör du läsa avsnittet “VIKTIGA SÄKERHETSANVISNINGAR” i Bruksanvisningen.

Se Bruksanvisningen för utförliga instruktioner. I denna guide används skärmbilder på engelska för grundläggande förklaringar.

Lue Käyttöohjeen kohta “TÄRKEITÄ TURVAOHJEITA” ennen kuin käytät konetta ensimmäisen kerran.

Yksityiskohtaisempia ohjeita löytyy koneen Käyttöohjeesta. Tässä oppaassa olevat näytön kuvat ovat englanninkielisen näytön mukaisia.

A készülék első alkalommal történő használatá előtt, kérjük, olvassa el a Használati útmutató „FONTOS BIZTONSÁGI UTASÍTÁSOK” c. részében foglaltakat.

A részletes utasításokért tekintse meg a Használati útmutatót. Ez az útmutató az alapvető magyarázatokat angol képernyőábrákkal szemlélteti.

Преди да използвате машината за първи път, моля, прочетете „ВАЖНИ ИНСТРУКЦИИ ЗА БЕЗОПАСНОСТ” в Ръководството за работа.

Вижте Ръководството за работа за подробни инструкции. За основни обяснения в това ръководство се използват екрани на английски език.

Før du bruker maskinen første gang må du lese “VIKTIGE SIKKERHETSINSTRUKSJONER” i Bruksanvisningen.

Du finner detaljerte instruksjoner i Bruksanvisningen. I denne veiledningen brukes engelske skjermbilder for grunnleggende forklaringer.

Læs “VIGTIGE SIKKERHEDSOPLYSNINGER” i Brugsanvisningen, før du tager maskinen i brug.

Se Brugsanvisningen for at få detaljerede instruktioner. Der anvendes displaybilleder på engelsk til basale forklaringer i denne vejledning.

Před prvním použitím stroje si prosím přečtěte „DŮLEŽITÉ BEZPEČNOSTNÍ POKYNY“ obsažené v Uživatelské příručce.

Podrobné pokyny naleznete v Uživatelské příručce. V této příručce jsou za účelem základních vysvětlení použity obrazovky v angličtině.

Przed rozpoczęciem pracy z maszyną przeczytaj „WAŻNE INSTRUKCJE DOTYCZĄCE BEZPIECZEŃSTWA” w Instrukcji obsługi.

Szczegółowe informacje można znaleźć w Instrukcji obsługi. W niniejszej instrukcji podstawowe elementy są ilustrowane ekranami w języku angielskim.

Înainte de a utiliza mașina pentru prima oară, citiți „INSTRUCȚIUNILE IMPORTANTE DE SIGURANȚĂ” din Manual de utilizare.

Consultați Manual de utilizare pentru instrucțiuni detaliate. În acest ghid, sunt utilizate ecrane în limba engleză pentru explicații de bază.

Operation Manual Notations

Descriptions in the Operation Manual are divided into those for Model 1, 2, 3 or 4, depending on the machine specifications. For this sewing machine, refer to descriptions for Model 1.

Bruksanvisningnotasjoner

Beskrivelsene i Bruksanvisningen er delt inn etter maskinspesifikasjonene for modell 1, 2, 3 eller 4. For denne symaskinen er det beskrivelsene for modell 1 som gjelder.

Beteckningar i Bruksanvisningen

Beskrivningarna i Bruksanvisningen är uppdelade efter modell 1, 2, 3 eller 4, beroende på maskinens specifikationer. Se beskrivningarna för modell 1 för denna symaskin.

Noter til Brugsanvisning

Beskrivelser i Brugsanvisningen er opdelt for model 1, 2, 3 og 4 afhængig af maskinspecifikationerne. For denne symaskine henviser beskrivelserne til model 1.

Käyttöohjeen merkinnät

Käyttöohjeessa olevat selosteet on jaettu koneen ominaisuuksien perusteella konemalleille 1, 2, 3 ja 4. Katso tälle ompelukoneelle konemallin 1 selosteita.

Označení v Uživatelské příručce

Popisy v Uživatelské příručce jsou rozděleny na popisy pro model 1, 2, 3 nebo 4 v závislosti na specifikacích stroje. Pro tento šicí stroj se zaměřte na popisy pro model 1.

A Használati útmutatóban használt jelölések

A Használati útmutatóban található leírások a készülék műszaki adatai alapján négy részre vannak tagolva: 1., 2., 3., illetve 4. modellre. Erre a varrógépre a 1. modell leírása vonatkozik.

Oznaczenia w Instrukcji obsługi

Opisy w Instrukcji obsługi są podzielone na dotyczące modelu 1, 2, 3 lub 4, w zależności od specyfikacji maszyny. W przypadku tej maszyny do szycia należy korzystać z opisów dotyczących modelu 1.

Обозначения в Ръководството за работа

Описанията в Ръководството за работа се разделят на такива за модел 1, 2, 3 или 4, в зависимост от спецификациите на машината. За тази шевна машина вижте описанията за модел 1.

Notațiile din Manual de utilizare

Descrierile din Manual de utilizare sunt împărțite în cele pentru Modelul 1, 2, 3 sau 4, în funcție de specificațiile mașinii. Pentru această mașină de cusut, consultați descrierile pentru Modelul 1.

Contents

Accessories	4
◆ Included Accessories	4
◆ Optional Accessories	4
Bobbin Winding and Setting	14
Upper Threading	16
Selecting and Sewing Patterns	18
◆ Preset Utility Stitches	18
◆ Utility Stitches	19
◆ Decorative Stitches	20
◆ Character stitches	20
Summary of Stitch Patterns	21
◆ Preset Utility Stitches	21
◆ Utility Stitches	21
◆ Decorative Stitches	21
◆ Character stitches	23

Innhold

Tilbehør	4
◆ Medfølgende tilbehør	4
◆ Ekstraustyr	4
Undertrådspoling og -innstilling	14
Treng av overtråd	16
Velge og sy mønstre	18
◆ Forhåndsinnstilte nyttesting	18
◆ Nyttesøm	19
◆ Prydsøm	20
◆ Tegnsøm	20
Sammendrag av sømmønstre	21
◆ Forhåndsinnstilte nyttesting	21
◆ Nyttesøm	21
◆ Prydsøm	21
◆ Tegnsøm	23

Innehåll

Tillbehör	6
◆ Medföljande tillbehör	6
◆ Extra tillbehör	6
Undertrådsspölning och inställning	14
Trä övertråden	16
Välja och sy mönster	18
◆ Förinställda nyttsömmar	18
◆ Nyttosömmar	19
◆ Dekorativa sömmar	20
◆ Monogramsömmar	20
Översikt över sömmar	21
◆ Förinställda nyttsömmar	21
◆ Nyttosömmar	21
◆ Dekorativa sömmar	21
◆ Monogramsömmar	23

Indholdsfortegnelse

Tilbehør	6
◆ Medfølgende tilbehør	6
◆ Ekstratilbehør	6
Opspoling af undertråd og indstilling	14
Trådning af overtråd	16
Valg og syning af sømme	18
◆ Forudindstillede nyttesøm	18
◆ Nyttesømme	19
◆ Pyntesømme	20
◆ Alfabet	20
Søm oversigt	21
◆ Forudindstillede nyttesøm	21
◆ Nyttesømme	21
◆ Pyntesømme	21
◆ Alfabet	23

Sisällysluettelo

Tarvikkeet	8
◆ Koneen mukana toimitetut tarvikkeet	8
◆ Lisätarvikkeet	8
Puolaus ja puolan asettaminen	14
Ylälangan langoitus	16
Ompeleiden valinta ja ompelu	18
◆ Esiasetetut hyötyompeleet	18
◆ Hyötyompeleet	19
◆ Koristeompeleet	20
◆ Kirjainmerkkiompeleet	20
Yhteenveto ompeleista	21
◆ Esiasetetut hyötyompeleet	21
◆ Hyötyompeleet	21
◆ Koristeompeleet	21
◆ Kirjainmerkkiompeleet	23

Obsah

Příslušenství	8
◆ Příložené příslušenství	8
◆ Doplňkové příslušenství	8
Navinutí a nasazení spodní cívky	14
Zavedení horní niti	16
Výběr vzorů a jejich šití	18
◆ Předvolba užitkových stehů	18
◆ Užitkové stehy	19
◆ Dekorativní stehy	20
◆ Znakové stehy	20
Souhrn vzorů stehů	21
◆ Předvolba užitkových stehů	21
◆ Užitkové stehy	21
◆ Dekorativní stehy	21
◆ Znakové stehy	23

Tartalomjegyzék

Tartozékok	10
◆ Mellékelt tartozékok	10
◆ Opcionális tartozékok	10
Alsószál orsózása és beállítása	14
Felsőszál befűzése	16
Minták kiválasztása és varrása	18
◆ Előbeállított haszonöltések	18
◆ Haszonöltések	19
◆ Diszítőöltések	20
◆ Karakteröltések	20
Az öltésminták összefoglalása	21
◆ Előbeállított haszonöltések	21
◆ Haszonöltések	21
◆ Diszítőöltések	21
◆ Karakteröltések	23

Spis treści

Akcesoria	10
◆ Akcesoria w zestawie.....	10
◆ Akcesoria opcjonalne.....	10
Nawijanie i ustawianie bębenka	14
Nawlekanie górnej nici	16
Wybór wzorów szycia	18
◆ Fabrycznie ustawione ściegi użytkowe.....	18
◆ Ściegi użytkowe	19
◆ Ściegi dekoracyjne	20
◆ Ściegi literowe.....	20
Podsumowanie wzorów ściegów	21
◆ Fabrycznie ustawione ściegi użytkowe.....	21
◆ Ściegi użytkowe	21
◆ Ściegi dekoracyjne	21
◆ Ściegi literowe.....	23

Съдържание

Акcesoари	12
◆ Акcesoари в комплекта	12
◆ Допълнителни акcesoари.....	12
Навиване и поставяне на калерчето	14
Горно вдяване	16
Избиране и шиене на шаблони	18
◆ Предварително зададени основни шевове.....	18
◆ Основни шевове	19
◆ Декоративни шевове	20
◆ Символни шевове.....	20
Обобщение на моделите шевове	21
◆ Предварително зададени основни шевове.....	21
◆ Основни шевове	21
◆ Декоративни шевове	21
◆ Символни шевове.....	23

Cuprins

Accesorii	12
◆ Accesoriiile incluse la livrare.....	12
◆ Accesorii optionale	12
Înfășurarea și introducerea firului bobinei	14
Înfilarea firului superior	16
Selectarea și brodarea modelelor	18
◆ Cusături utilitare presetate	18
◆ Cusături utilitare.....	19
◆ Cusături decorative	20
◆ Cusături caractere.....	20
Modele de cusături	21
◆ Cusături utilitare presetate	21
◆ Cusături utilitare.....	21
◆ Cusături decorative	21
◆ Cusături caractere.....	23

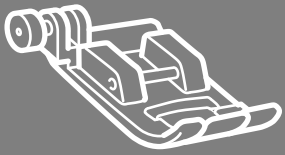

Accessories

Tilbehør

◆ Included Accessories

◆ Medfølgende tilbehør

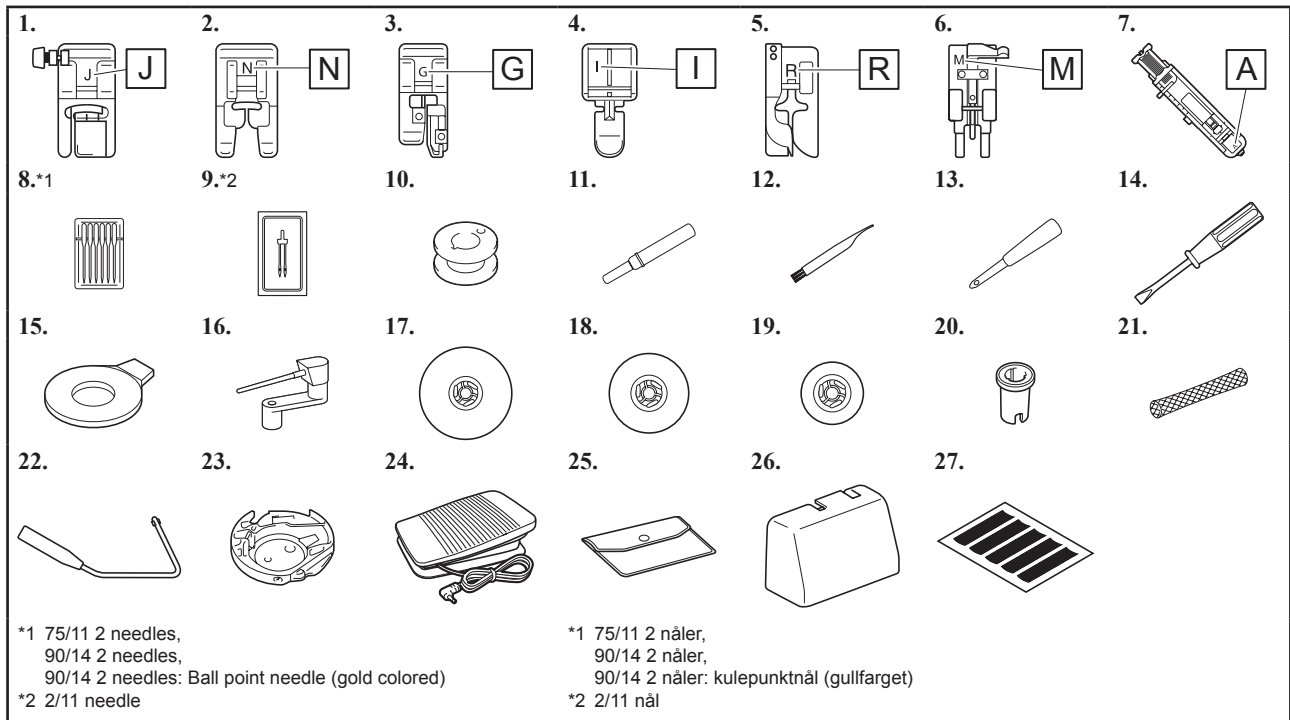

◆ Optional Accessories

◆ Ekstra utstyr

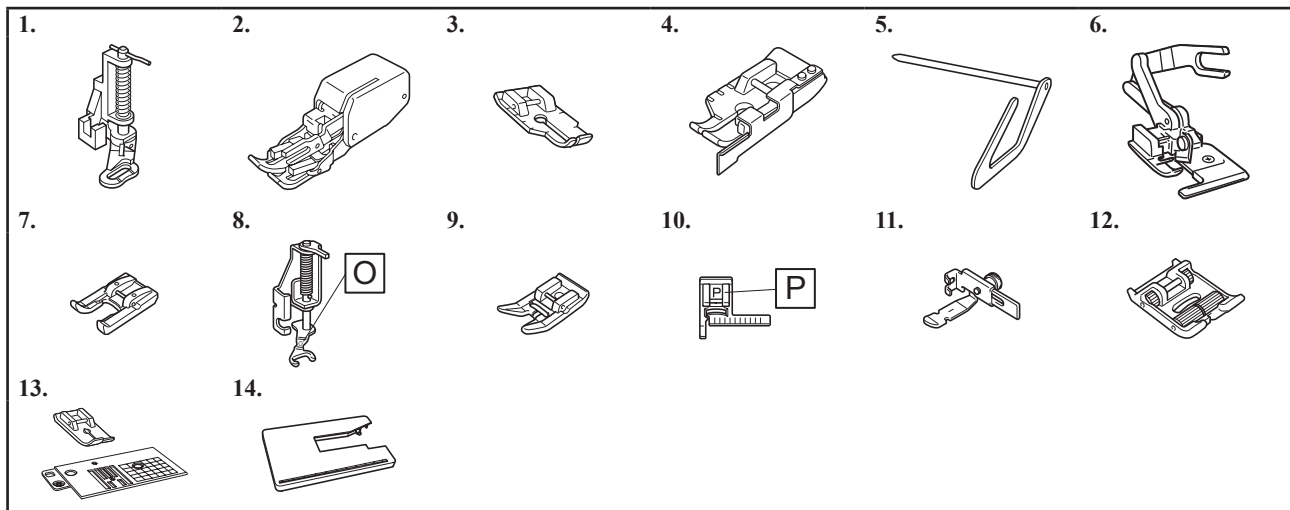

Note

- The presser foot holder screw is available through your authorized Brother dealer. (Part code: XG1343-001)
- The presser foot accessory tray is available, through your authorized Brother dealer. (Part code: XF8650-001)



Bemerk

- Trykkføtholderskruen er tilgjengelig via autoriserte Brother-forhandlere. (Delekode: XG1343-001)
- Tilbehørsskuffen for trykkføtter er tilgjengelig via autoriserte Brother-forhandlere. (Delekode: XF8650-001)

◆ Included Accessories

No.	Part Name	Part Code	
		Americas	Others
1	Zigzag foot "J" (on machine)		XF3022-001
2	Monogramming foot "N"		XD0810-031
3	Overcasting foot "G"		XC3098-031
4	Zipper foot "I"		X59370-021
5	Blind stitch foot "R"		XE2650-001
6	Button fitting foot "M"		XE2643-001
7	Buttonhole foot "A"		XC2691-023
8	Needle set		X58358-021
9	Twin needle		X59296-121
10	Bobbin (4) (One is on machine.)	SA156*3	SFB: XA5539-151
11	Seam ripper		XF4967-001
12	Cleaning brush		X59476-051
13	Eyelet punch		XZ5051-001
14	Screwdriver		XC8349-021
15	Disc-shaped screwdriver		XC1074-051
16	Horizontal spool pin		XC4654-251
17	Spool cap (large)		130012-024
18	Spool cap (medium) (2) (One is on machine.)		XE1372-001
19	Spool cap (small)		130013-124
20	Thread spool insert (mini king thread spool)		XA5752-121
21	Spool net		XA5523-020
22	Knee lifter		XA6941-052
23	Bobbin case (on machine)		XG2058-001
24	Foot controller	XZ5098-001(EU area) XZ5100-001(other areas)	
25	Accessory bag		XC4487-021
26	Hard case		XG5628-001
27	Grid sheet set		XC4549-020

*3 SA156 is Class15 type bobbin.

◆ Medfølgende tilbehør

Nr.	Delenavn	Delekode	
		Nord-, Mellom- og Sør-Amerika	Andre
1	Sikksakkfot "J" (på maskinen)		XF3022-001
2	Monogramfot "N"		XD0810-031
3	Overkastfot "G"		XC3098-031
4	Glidelåsfot "I"		X59370-021
5	Blindstingsfot "R"		XE2650-001
6	Knappsvingsfot "M"		XE2643-001
7	Knapphullsfot "A"		XC2691-023
8	Nålsett		X58358-021
9	Dobbeltål		X59296-121
10	Spole (4) (Én er på maskinen.)	SA156*3	SFB: XA5539-151
11	Sprettekniv		XF4967-001
12	Børste		X59476-051
13	Hullsyl		XZ5051-001
14	Skrutrekker		XC8349-021
15	Skiveformet skrutrekker		XC1074-051
16	Horisontal spolepinne		XC4654-251
17	Spolestopper (stor)		130012-024
18	Spolestopper (middels) (2) (Én er på maskinen.)		XE1372-001
19	Spolestopper (liten)		130013-124
20	Trådspoleinnlegg (mini-kingtrådspole)		XA5752-121
21	Trådnett		XA5523-020
22	Kneløfter		XA6941-052
23	Spolehus (på maskinen)		XG2058-001
24	Fotpedal	XZ5098-001(EU-området) XZ5100-001(andre områder)	
25	Tilbehørspose		XC4487-021
26	Hard eske		XG5628-001
27	Ruteark		XC4549-020

*3 SA156 er en spole av klasse 15.

◆ Optional Accessories

The following are available as optional accessories to be purchased separately from your authorized Brother dealer.

No.	Part Name	Part Code	
		Americas	Others
1	Quilting foot	SA129	F005N: XC1948-052
2	Walking foot	SA140	F033N: XC2214-052
3	1/4" quilting foot	SA125	F001N: XC1944-052
4	1/4" quilting foot with guide	SA185	F057: XC7416-252
5	Quilting guide	SA132	F016N: XC2215-052
6	Side cutter "S"	SA177	F054: XC3879-152
7	Open toe foot	SA186	F060: XE1094-101
8	Free motion open toe quilting foot "O"	SA187	F061: XE1097-001
9	Non stick foot	SA114	F007N: XC1949-052
10	Stitch guide foot "P"	SA160	F035N: XC1969-052
11	Adjustable zipper/piping foot	SA161	F036N: XC1970-052
12	Roller foot	SA190	F066: XF1723-001
13	Straight stitch foot and needle plate set	SA564 SA564C (Kanada)	SNP02: XG0946-001 SNP02AP: XG0948-001
14	Wide table	SAWT4	WT14: XG5051-001 WT14AP: XG4656-001

◆ Ekstrautstyr

Følgende er tilgjengelig som ekstrautstyr som kan kjøpes separat fra din autoriserte Brother-forhandler.

Nr.	Delenavn	Delekode	
		Nord-, Mellom- og Sør-Amerika	Andre
1	Quiltefot	SA129	F005N: XC1948-052
2	Overtransportør	SA140	F033N: XC2214-052
3	1/4" quiltefot	SA125	F001N: XC1944-052
4	1/4" quiltefot med leder	SA185	F057: XC7416-252
5	Quilteguide	SA132	F016N: XC2215-052
6	Kantskjærer "S"	SA177	F054: XC3879-152
7	Fot med åpen tupp	SA186	F060: XE1094-101
8	Frihåndskviltefot "O" med åpen tupp	SA187	F061: XE1097-001
9	Fleksibel fot	SA114	F007N: XC1949-052
10	Sømførefot "P"	SA160	F035N: XC1969-052
11	Justerbar glidelås-/kantefot	SA161	F036N: XC1970-052
12	Rullefot	SA190	F066: XF1723-001
13	Rettsømfot og nåleplatesett	SA564 SA564C (Canada)	SNP02: XG0946-001 SNP02AP: XG0948-001
14	Bredt bord	SAWT4	WT14: XG5051-001 WT14AP: XG4656-001

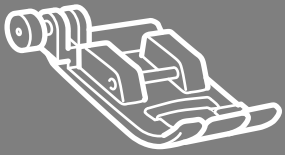

Tillbehör

Tilbehør

◆ Medföljande tillbehör

◆ Medföljende tilbehør

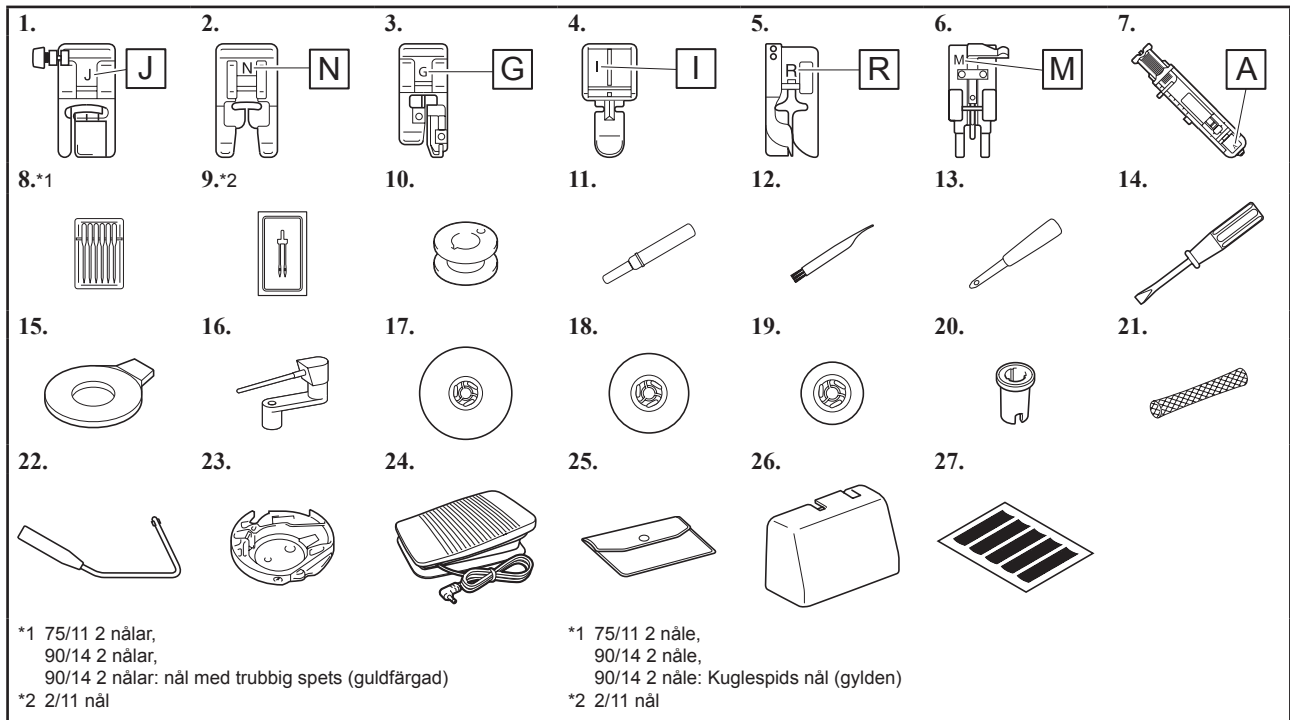

◆ Extra tillbehör

◆ Ekstratilbehør

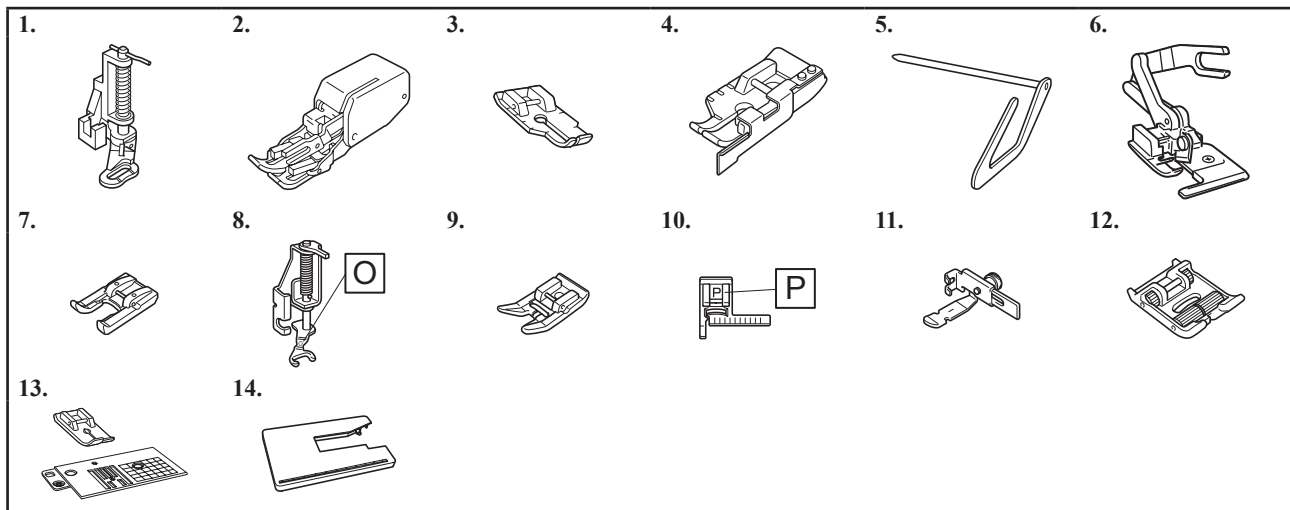

Obs!

- Pressarfotshållarens skruv är tillgänglig via din auktoriserade Brother-återförsäljare. (Artikelkod: XG1343-001)
- Pressarfotens tillbehörsfack är tillgänglig via din auktoriserade Brother-återförsäljare. (Artikelkod: XF8650-001)



Bemærk

- Skruen til snap-on delen kan fås hos en autoriseret Brother-forhandler. (Reservedelskode: XG1343-001)
- Tilbehørsbakke til trykfoden kan fås hos en autoriseret Brother-forhandler. (Delkode: XF8650-001)

◆ Medfølgende tilbehør

Nr	Artikelnamn	Artikelnummer	
		Amerika	Övriga
1	Sicksackspressarfot "J" (på maskinen)		XF3022-001
2	Monogramfot "N"		XD0810-031
3	Fällningsfot "G"		XC3098-031
4	Blixtläsfot "I"		X59370-021
5	Blindsömsfot "R"		XE2650-001
6	Knappfot "M"		XE2643-001
7	Knapphålsfot "A"		XC2691-023
8	Nåluppsättning		X58358-021
9	Tvillingnål		X59296-121
10	Spole (4) (En sitter i maskinen.)	SA156*3	SFB: XA5539-151
11	Sprättkniv		XF4967-001
12	Rengöringsborste		X59476-051
13	Hålstans		XZ5051-001
14	Skruvmejsel		XC8349-021
15	Skivformad skruvmejsel		XC1074-051
16	Horisontellt trådrollsstativ		XC4654-251
17	Spolkåpa (stor)		130012-024
18	Spolkåpa (medium) (2) (En sitter i maskinen.)		XE1372-001
19	Spolkåpa (liten)		130013-124
20	Trådrolleinsats (Mini-king trådrolle)		XA5752-121
21	Spolnät		XA5523-020
22	Knästyrd pressarfotslyftare		XA6941-052
23	Spolkapseln (på maskinen)		XG2058-001
24	Fotpedal	XZ5098-001(EU) XZ5100-001(övriga länder)	
25	Tillbehörsväska		XC4487-021
26	Hårt fodral		XG5628-001
27	Rutnät		XC4549-020

*3 SA156 är en spole av typ Klass15.

◆ Medfølgende tilbehør

Nr.	Reservedelsnavn	Reservedelskode	
		Nord- og Sydamerika	Andre
1	Zigzagtrykfod "J" (på maskinen)		XF3022-001
2	Pyntesømsfod "N"		XD0810-031
3	Overlocktrykfod "G"		XC3098-031
4	Lynslåsfod "I"		X59370-021
5	Blindstingsfod "R"		XE2650-001
6	Trykfod "M" til isyning af knapper		XE2643-001
7	Knaphulsfod "A"		XC2691-023
8	Nålesæt		X58358-021
9	Dobbeltlån		X59296-121
10	Spole (4) (En sidder på maskinen.)	SA156*3	SFB: XA5539-151
11	Opsprætter		XF4967-001
12	Børste		X59476-051
13	Hulsyl		XZ5051-001
14	Skruetrækker		XC8349-021
15	Skiveformet skruetrækker		XC1074-051
16	Vandret spolepind		XC4654-251
17	Spolehætte (stor)		130012-024
18	Spolehætte (medium) (2) (En sidder på maskinen.)		XE1372-001
19	Spolehætte (lille)		130013-124
20	Trådspoleinsats (mini-king-trådspole)		XA5752-121
21	Trådnet		XA5523-020
22	Knæløfter		XA6941-052
23	Spolehus (på maskinen)		XG2058-001
24	Fodpedal	XZ5098-001 (EU) XZ5100-001 (andre områder)	
25	Tilbehørspose		XC4487-021
26	Transportkasse		XG5628-001
27	Gitterarksæt		XC4549-020

*3 SA156 er en spole af typen Class15.

◆ Extra tilbehør

Följande finns som tillval och kan köpas separat från en auktoriserad Brother-återförsäljare.

Nr	Artikelnamn	Artikelnummer	
		Amerika	Övriga
1	Kviltningsfot	SA129	F005N: XC1948-052
2	Övermatare	SA140	F033N: XC2214-052
3	1/4-tums kviltningfot	SA125	F001N: XC1944-052
4	1/4-tums kviltningfot med styrning	SA185	F057: XC7416-252
5	Kviltningstyrning	SA132	F016N: XC2215-052
6	Sidokniv "S"	SA177	F054: XC3879-152
7	Öppen pressarfot	SA186	F060: XE1094-101
8	Öppen kviltningfot "O" för friarmsläge	SA187	F061: XE1097-001
9	Fot som inte fastnar	SA114	F007N: XC1949-052
10	Stygplåt "P"	SA160	F035N: XC1969-052
11	Justerbar blixtläs-/kantbandsfot	SA161	F036N: XC1970-052
12	Rullfot	SA190	F066: XF1723-001
13	Raksömsfot och nålplatta	SA564 SA564C (Kanada)	SNP02: XG0946-001 SNP02AP: XG0948-001
14	Brett bord	SAWT4	WT14: XG5051-001 WT14AP: XG4656-001

◆ Ekstratilbehør

Följende kan fås som ekstraudstyr, der købes separat hos din autoriserede Brother-forhandler.

Nr.	Reservedelsnavn	Reservedelskode	
		Nord- og Sydamerika	Andre
1	Quiltfod	SA129	F005N: XC1948-052
2	Overtransportør	SA140	F033N: XC2214-052
3	1/4 tomme quiltfod	SA125	F001N: XC1944-052
4	1/4 tomme quiltfod med styr	SA185	F057: XC7416-252
5	Quiltelineal	SA132	F016N: XC2215-052
6	Kantskærer "S"	SA177	F054: XC3879-152
7	Åbenfod	SA186	F060: XE1094-101
8	Frihåndsåbenquiltfod "O"	SA187	F061: XE1097-001
9	Glidesål	SA114	F007N: XC1949-052
10	Linealfod "P"	SA160	F035N: XC1969-052
11	Justerbar lynlås-/titekantsfod	SA161	F036N: XC1970-052
12	Rullefod	SA190	F066: XF1723-001
13	Sæt med ligestingsfod og stingplade til lige sting	SA564 SA564C (Canada)	SNP02: XG0946-001 SNP02AP: XG0948-001
14	Forlængerbord	SAWT4	WT14: XG5051-001 WT14AP: XG4656-001

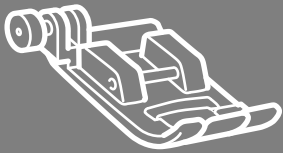

Tarvikkeet

Přislúšenství

◆ Koneen mukana toimitetut tarvikkeet

◆ Přiložené příslušenství

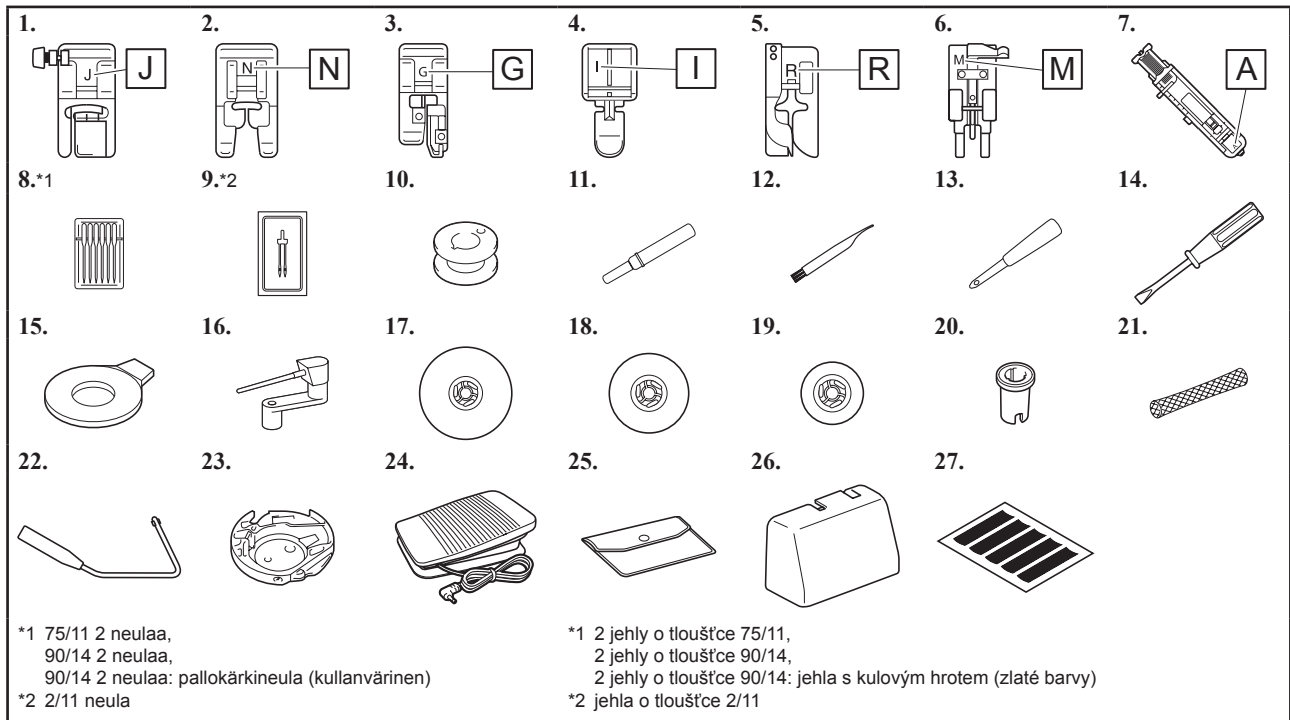

◆ Lisätarvikkeet

◆ Doplnkové příslušenství

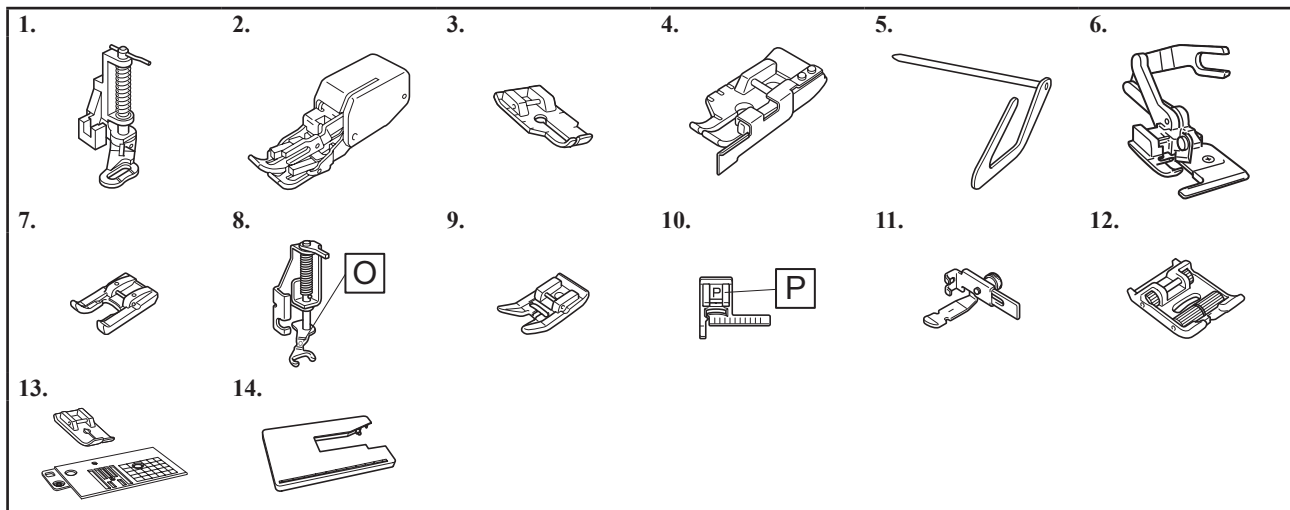

Vinkki

- Paininjalan runko-osan ruuvi on saatavana valtuutetulta Brother-jälleenmyyjältä. (Tuotekoodi: XG1343-001)
- Paininjalan säilytyslokero on saatavana valtuutetulta Brother-jälleenmyyjältä. (Tuotekoodi: XF8650-001)



Poznámka

- Šroub držáku přítlačné patky je k dispozici u vašeho autorizovaného prodejce Brother. (Číslo dílu: XG1343-001)
- Plato příslušenství přítlačné patky je k dispozici u vašeho autorizovaného prodejce Brother. (Číslo dílu: XF8650-001)

◆ Koneen mukana toimitetut tarvikkeet

Nro	Osan nimi	Tuotekoodi	
		Amerikat	Muut
1	Siksakpaininjalka "J" (koneessa)		XF3022-001
2	Koristeommeljalja "N"		XD0810-031
3	Yliuottelujalka "G"		XC3098-031
4	Vetoketjujalka "I"		X59370-021
5	Piilo-ommeljalja "R"		XE2650-001
6	Napinompelujalka "M"		XE2643-001
7	Napiniäpjalja "A"		XC2691-023
8	Neulapakkaus		X58358-021
9	Kaksoisneula		X59296-121
10	Puola (4) (yksi koneessa)	SA156*3	SFB: XA5539-151
11	Ratkoja		XF4967-001
12	Puhdistusharja		X59476-051
13	Lävistäjä		XZ5051-001
14	Ruuvitalta		XC8349-021
15	Pyöreä ruuvitalta		XC1074-051
16	Lisälankatappi		XC4654-251
17	Lankarullan pidike (suuri)		130012-024
18	Lankarullan pidike (keskikokoinen) (2) (yksi koneessa.)		XE1372-001
19	Lankarullan pidike (pieni)		130013-124
20	Lankarullan lisäosa (mini king-lankarulla)		XA5752-121
21	Lankarullan verkko		XA5523-020
22	Polvinostin		XA6941-052
23	Puolaketelo (koneessa)		XG2058-001
24	Jalkasäädin		XZ5098-001 (EU-alue) XZ5100-001 (muut maat)
25	Tarvikepussi		XC4487-021
26	Suojaketelo		XG5628-001
27	Ruutuarkkisarja		XC4549-020

*3 SA156 on tyypiltään Class15 puola.

◆ Priiloženē přislušenství

Č.	Název součásti	Kód součásti	
		Jižní a Severní Amerika	Ostatní
1	Patka cik-cak „J“ (ve stroji)		XF3022-001
2	Patka na monogramy „N“		XD0810-031
3	Patka overlocková „G“		XC3098-031
4	Patka zipová „I“		X59370-021
5	Patka pro slepý steh „R“		XE2650-001
6	Patka pro našívání knoflíků „M“		XE2643-001
7	Patka pro šití dírek „A“		XC2691-023
8	Sada jehel		X58358-021
9	Dvoujehla		X59296-121
10	Cívka (4) (Jedna je ve stroji.)	SA156*3	SFB: XA5539-151
11	Páráček		XF4967-001
12	Čisticí štěteček		X59476-051
13	Děrouvačka		XZ5051-001
14	Šroubovák		XC8349-021
15	Kotoučovitý šroubovák		XC1074-051
16	Horizontální trn cívky vrchní nitě		XC4654-251
17	Krytka cívky vrchní nitě (velká)		130012-024
18	Krytka cívky vrchní nitě (střední) (2) (Jedna je ve stroji.)		XE1372-001
19	Krytka cívky vrchní nitě (malá)		130013-124
20	Vložka cívky vrchní nitě (mini cívka na silnou nit)		XA5752-121
21	Šítko cívky vrchní nitě		XA5523-020
22	Kolenní páka		XA6941-052
23	Pouzdro cívky spodní nitě (na stroji)		XG2058-001
24	Nožní pedál		XZ5098-001 (EU) XZ5100-001 (ostatní oblasti)
25	Taška na příslušenství		XC4487-021
26	Pevný kryt		XG5628-001
27	Sada mřížkových listů		XC4549-020

*3 SA156 je spodní nit typu Class15.

◆ Lisätarvikkeet

Seuraavat ovat saatavana valtuutetulta Brother-jälleenmyyjältä erikseen ostettavina lisätarvikkeina.

Nro	Osan nimi	Tuotekoodi	
		Amerikat	Muut
1	Vanutikkajalka	SA129	F005N: XC1948-052
2	Yläsyöttäjä	SA140	F033N: XC2214-052
3	Tiikkutyöjalka	SA125	F001N: XC1944-052
4	Tiikkutyöjalka kankaan reunan ohjaimella	SA185	F057: XC7416-252
5	Tikkausohjain	SA132	F016N: XC2215-052
6	Leikkuri "S"	SA177	F054: XC3879-152
7	Avoin paininjalka	SA186	F060: XE1094-101
8	Avoin vanutikkajalka "O"	SA187	F061: XE1097-001
9	Luistavapohjainen paininjalka	SA114	F007N: XC1949-052
10	Ompeleen ohjajalka "P"	SA160	F035N: XC1969-052
11	Säädettävä vetoketju-/terepaininjalka	SA161	F036N: XC1970-052
12	Rullapaininjalka	SA190	F066: XF1723-001
13	Suoraommeljalja ja suoraompeleestoylevy, pakkaus	SA564 SA564C (Kanada)	SNP02: XG0946-001 SNP02AP: XG0948-001
14	Suuri aputaso	SAWT4	WT14: XG5051-001 WT14AP: XG4656-001

◆ Doplnkové příslušenství

Následující položky jsou k dispozici jako volitelné příslušenství, které lze zakoupit samostatně u autorizovaného prodejce Brother.

Č.	Název součásti	Kód součásti	
		Jižní a Severní Amerika	Ostatní
1	Quiltovací patka	SA129	F005N: XC1948-052
2	Kráčející patka	SA140	F033N: XC2214-052
3	1/4" quiltovací patka	SA125	F001N: XC1944-052
4	1/4" quiltovací patka s vodítkem	SA185	F057: XC7416-252
5	Quiltovací vodítko	SA132	F016N: XC2215-052
6	Patka s bočním ořezem „S“	SA177	F054: XC3879-152
7	Patka otevřená	SA186	F060: XE1094-101
8	Patka na volné quiltování otevřená „O“	SA187	F061: XE1097-001
9	Oblá patka	SA114	F007N: XC1949-052
10	Patka se stehovým vodítkem „P“	SA160	F035N: XC1969-052
11	Stavitelná zipová/paspučková obrubovací patka	SA161	F036N: XC1970-052
12	Válečková patka	SA190	F066: XF1723-001
13	Patka na rovný steh a sada krytu stehové desky	SA564 SA564C (Kanada)	SNP02: XG0946-001 SNP02AP: XG0948-001
14	Široký stůl	SAWT4	WT14: XG5051-001 WT14AP: XG4656-001

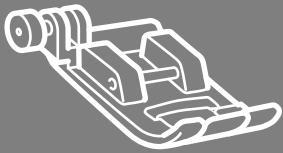

Tartozék

Akcesoria

◆ Mellékelt tartozék

◆ Akcesoria w zestawie

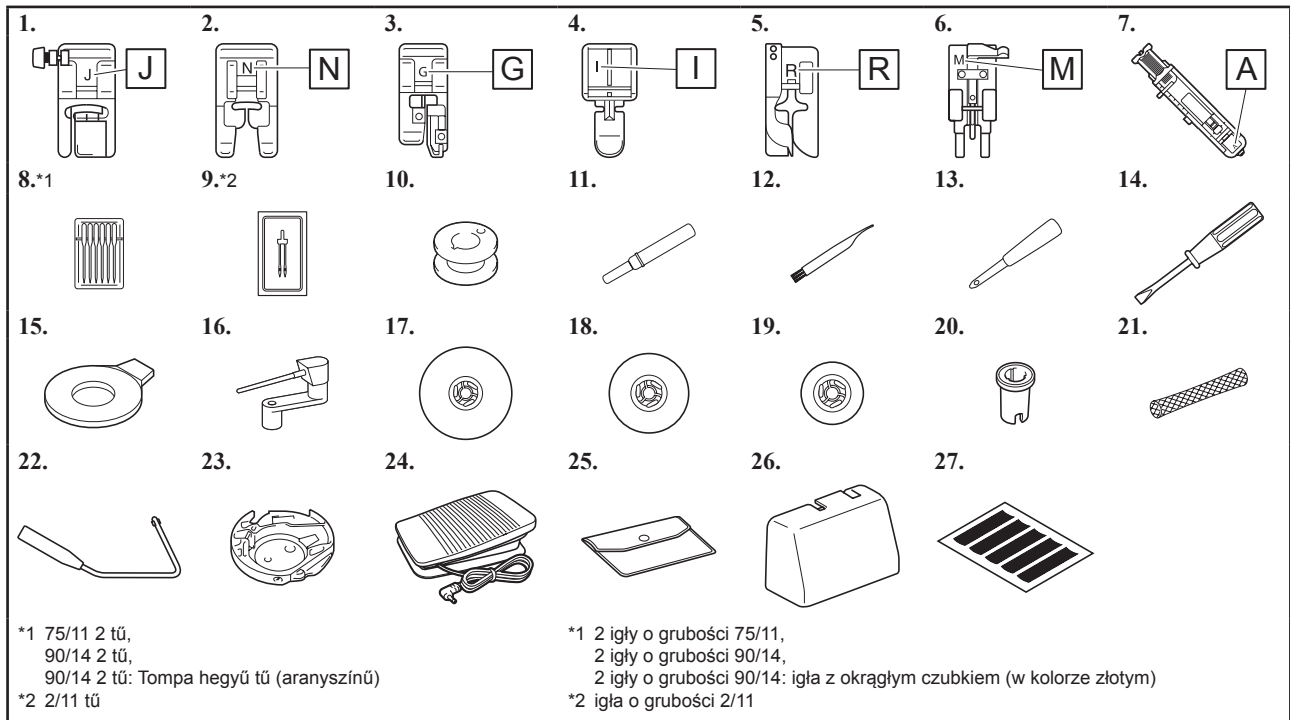

◆ Opcionális tartozék

◆ Akcesoria opcjonalne

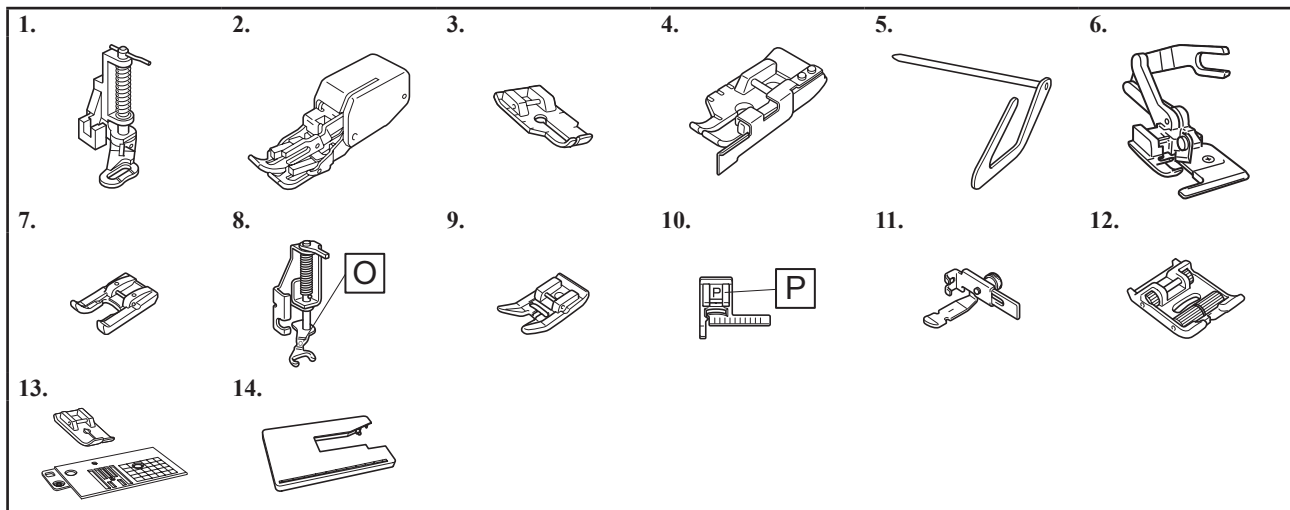

Megjegyzés

- A nyomótalptartó csavar a hivatalos Brother kereskedőnél kapható. (Tartozék kódja: XG1343-001)
- A nyomótalptartozék tálcája a hivatalos Brother kereskedőnél kapható. (Tartozék kódja: XF8650-001)



Uwaga

- Śrubę uchwyty stopki można zamówić u autoryzowanego sprzedawcy produktów firmy Brother. (Kod części: XG1343-001)
- Tackę na akcesoria stopki można zamówić u autoryzowanego sprzedawcy produktów firmy Brother. (Kod części: XF8650-001)

◆ Mellékelt tartozékok

Sz.	Tartozék megnevezése	Tartozék kódja	
		Amerika	Egyéb
1	„J” cikcakk talp (a gépen)		XF3022-001
2	„N” monogramvarró talp		XD0810-031
3	„G” szegőtálp		XC3098-031
4	„I” cipzárvarró talp		X59370-021
5	„R” vaköltés talp		XE2650-001
6	„M” gombfelvarró talp		XE2643-001
7	„A” gomblyukvarró talp		XC2691-023
8	Tűkészlet		X58358-021
9	Ikertű		X59296-121
10	Orsó (4) (egy a gépen)	SA156*3	SFB: XA5539-151
11	Varrásfejítő		XF4967-001
12	Tisztítókefe		X59476-051
13	Ár		XZ5051-001
14	Csavarhúzó		XC8349-021
15	Korong alakú csavarhúzó		XC1074-051
16	Vízszintes orsótűske		XC4654-251
17	Orsósapka (nagy)		130012-024
18	Orsósapka (közepes) (2) (egy a gépen)		XE1372-001
19	Orsósapka (kicsi)		130013-124
20	Cérnaorsóbetét (mini king cérnaorsó)		XA5752-121
21	Orsóhál		XA5523-020
22	Térdemelő		XA6941-052
23	Orsótok (a gépen)		XG2058-001
24	Pedál	XZ5098-001(EU-terület) XZ5100-001(egyéb területek)	
25	Tartozéktaşak		XC4487-021
26	Kemény tok		XG5628-001
27	Rácslapkészlet		XC4549-020

*3 Az SA156 egy Class15 típusú orsó.

◆ Akcesoria w zestawie

Nr	Nazwa części	Kod części	
		Amerika Północna i Południowa	Inne
1	Stopka do ściegu zygzakowego „J” (w maszynie)		XF3022-001
2	Stopka do monogramów „N”		XD0810-031
3	Stopka do obrębiania „G”		XC3098-031
4	Stopka do wszywania zamków błyskawicznych „I”		X59370-021
5	Stopka do ściegu krytego „R”		XE2650-001
6	Stopka do wszywania guzików „M”		XE2643-001
7	Stopka do obszywania dziurek „A”		XC2691-023
8	Zestaw igieł		X58358-021
9	Igła podwójna		X59296-121
10	Szpulka dolna (4) (Jeden znajduje się w maszynie.)	SA156*3	SFB: XA5539-151
11	Nóż do szwów		XF4967-001
12	Szczotka do czyszczenia		X59476-051
13	Dziurkacz		XZ5051-001
14	Śrubokręt		XC8349-021
15	Śrubokręt w kształcie dysku		XC1074-051
16	Poziomy trzpień szpulki		XC4654-251
17	Nasadka szpulki (duża)		130012-024
18	Nasadka szpulki (średnia) (2) (Jedna sztuka znajduje się w maszynie.)		XE1372-001
19	Nasadka szpulki (mała)		130013-124
20	Wkładka szpulki z nicią (szpulka z nicią mini king)		XA5752-121
21	Siatka na szpulkę		XA5523-020
22	Podnośnik kolanowy		XA6941-052
23	Bęberek (w maszynie)		XG2058-001
24	Moduł sterowania stopką		XZ5098-001(obszar UE) XZ5100-001(inne obszary)
25	Torba na akcesoria		XC4487-021
26	Szywny futerał		XG5628-001
27	Zestaw arkuszy z siatką		XC4549-020

*3 SA156 to szpulka dolna typu Class15.

◆ Opcjonalis tartozékok

Az alábbi tételek a hivatalos Brother-kereskedőnél külön megvásárolható, opcionális tartozékok.

Sz.	Tartozék megnevezése	Tartozék kódja	
		Amerika	Egyéb
1	Öltésvezető (tűző) talp	SA129	F005N: XC1948-052
2	Felső anyagtovábbító talp	SA140	F033N: XC2214-052
3	1/4" öltésvezető (tűző) talp	SA125	F001N: XC1944-052
4	1/4" öltésvezető (tűző) talp vezetővel	SA185	F057: XC7416-252
5	Öltésvezető	SA132	F016N: XC2215-052
6	„S” oldalvágó	SA177	F054: XC3879-152
7	Nyitott talp	SA186	F060: XE1094-101
8	„O” szabad mozgású nyitott öltésvezető (tűző) talp	SA187	F061: XE1097-001
9	Tapadásmentes talp	SA114	F007N: XC1949-052
10	„P” öltésvezető talp	SA160	F035N: XC1969-052
11	Állítható cipzárta/p/kédertalp	SA161	F036N: XC1970-052
12	Görgőtálp	SA190	F066: XF1723-001
13	Egyenes öltőtálp és tülemez készlet	SA564 SA564C (Kanada)	SNP02: XG0946-001 SNP02AP: XG0948-001
14	Széles tábla	SAWT4	WT14: XG5051-001 WT14AP: XG4656-001

◆ Akcesoria opcjonalne

Poniższe akcesoria są dostępne jako akcesoria opcjonalne, do kupienia oddzielnie u autoryzowanego dystrybutora firmy Brother.

Nr	Nazwa części	Kod części	
		Amerika Północna i Południowa	Inne
1	Stopka do pikowania	SA129	F005N: XC1948-052
2	Stopka krocząca	SA140	F033N: XC2214-052
3	Stopka do pikowania 1/4"	SA125	F001N: XC1944-052
4	Stopka do pikowania 1/4" z przewodnikiem	SA185	F057: XC7416-252
5	Prowadnik do pikowania	SA132	F016N: XC2215-052
6	Przecinak do brzegów „S”	SA177	F054: XC3879-152
7	Stopka otwarta	SA186	F060: XE1094-101
8	Otwarta stopka do pikowania „O” umożliwiająca swobodne poruszanie materiałem	SA187	F061: XE1097-001
9	Stopka z materiału nieprzywierającego	SA114	F007N: XC1949-052
10	Stopka z przewodnikiem „P”	SA160	F035N: XC1969-052
11	Regulowana stopka do wszywania zamków/lamówek	SA161	F036N: XC1970-052
12	Stopka rolkowa	SA190	F066: XF1723-001
13	Stopka do ściegów prostych i zestaw płytki igły	SA564 SA564C (Kanada)	SNP02: XG0946-001 SNP02AP: XG0948-001
14	Szeroki stolik	SAWT4	WT14: XG5051-001 WT14AP: XG4656-001

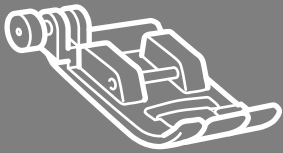

Акcesoари

Accesorii

◆ Акcesoари в комплекта

◆ Accesoriiile incluse la livrare

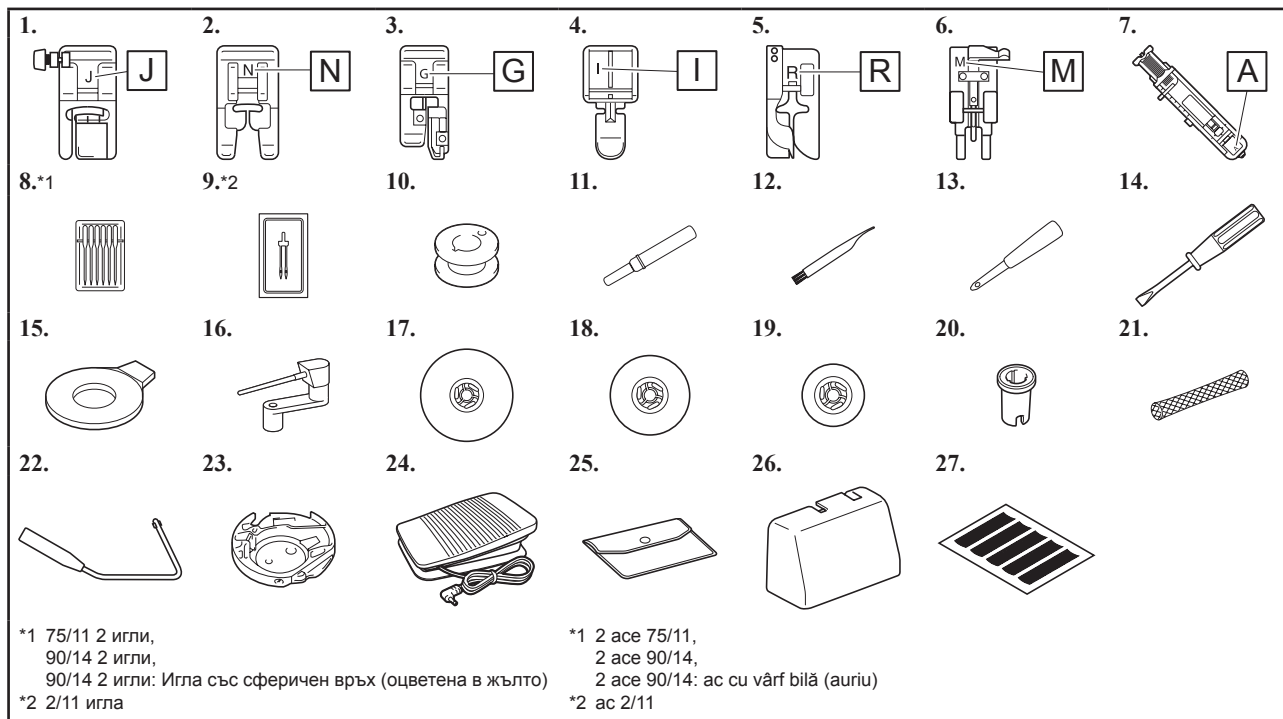

◆ Допълнителни акcesoари

◆ Accesoriiile opționale

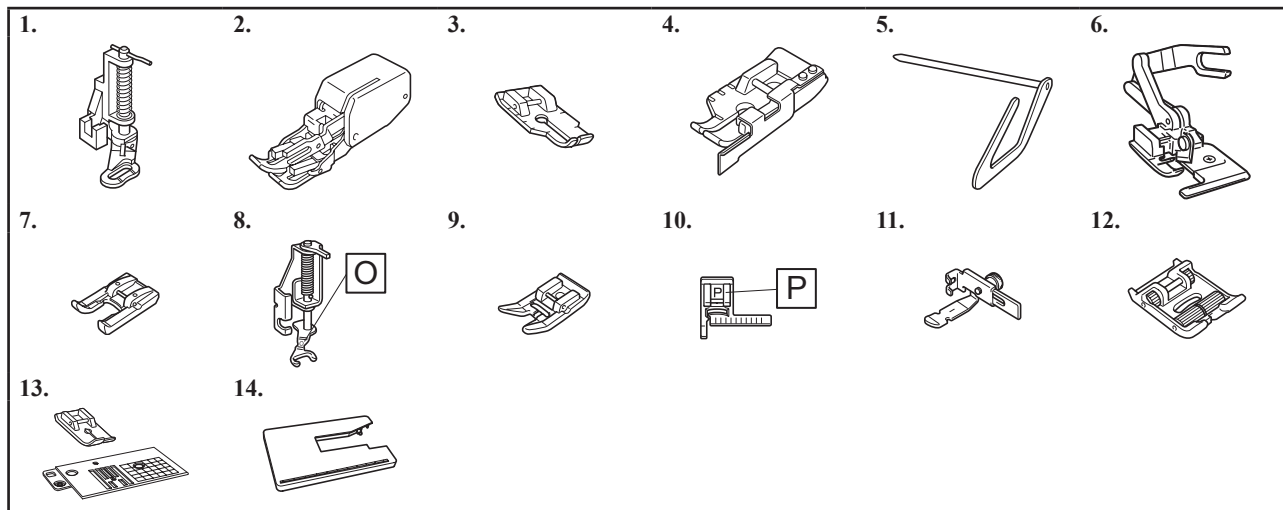

Забележка

- Винтът на носача на притискащото краче можете да намерите при оторизирания дилър на Brother. (Код на частта: XG1343-001)
- Кутията с акcesoари на притискащото краче можете да намерите при оторизирания дилър на Brother. (Код на частта: XF8650-001)



Notă

- Şurubul suportului picioruşului presor poate fi comandat de la dealerul autorizat Brother. (Cod piesă: XG1343-001)
- Tava accesoriu a picioruşului presor poate fi comandată de la dealerul autorizat Brother. (Cod piesă: XF8650-001)

◆ Аксесоари в комплекта

№	Наименование на частта	Код на частта	
		Северна и Южна Америка	Други
1	Краче за „зигзаг „J” (на машината)		XF3022-001
2	Краче за бродерии „N”		XD0810-031
3	Краче за оверлочен бод „G”		XC3098-031
4	Краче за ципове „I”		X59370-021
5	Краче за скрит шев „R”		XE2650-001
6	Краче за зашиване на копчета „M”		XE2643-001
7	Краче за илици „A”		XC2691-023
8	Комплект игли		X58358-021
9	Двойна игла		X59296-121
10	Калерче (4) (едното е на машината)	SA156*3	SFB: XA5539-151
11	Нож за срязване на шевове		XF4967-001
12	Четка за почистване		X59476-051
13	Перфоратор за поставяне на айлети		XZ5051-001
14	Отвертка		XC8349-021
15	Отвертка с формата на диск		XC1074-051
16	Хоризонтален шифт за макара		XC4654-251
17	Капачка на макарата (голяма)		130012-024
18	Капачка на макарата (средна) (2) (едната е на машината)		XE1372-001
19	Капачка на макарата (малка)		130013-124
20	Поставка за макара (малка макара)		XA5752-121
21	Мрежа за макара		XA5523-020
22	Повдигач за коляно		XA6941-052
23	Капсула на калерчето (на машината)		XG2058-001
24	Педал	XZ5098-001(област на ЕС) XZ5100-001(други области)	
25	Чанта за аксесоари		XC4487-021
26	Куфар		XG5628-001
27	Комплект лист с мрежа		XC4549-020

*3 SA156 е тип калерче от клас 15.

◆ Аксесоари включени в доставката

Nr. crt.	Denumire piesă	Cod piesă	
		America	Алте региони
1	Picioruș zigzag „J” (pe mașină)		XF3022-001
2	Picioruș pentru monograme „N”		XD0810-031
3	Picioruș de surfilare „G”		XC3098-031
4	Picioruș pentru fermoar „I”		X59370-021
5	Picioruș pentru cusătură invizibilă „R”		XE2650-001
6	Picioruș pentru nasturi „M”		XE2643-001
7	Picioruș pentru butonieră „A”		XC2691-023
8	Set de ace		X58358-021
9	Ac dublu		X59296-121
10	Bobină (4) (Una este montată pe mașină.)	SA156*3	SFB: XA5539-151
11	Dispozitiv de desfăcut cusături		XF4967-001
12	Perie pentru curățat		X59476-051
13	Perforator de capse		XZ5051-001
14	Șurubelniță		XC8349-021
15	Șurubelniță în formă de disc		XC1074-051
16	Ax de mosor orizontal		XC4654-251
17	Capac pentru mosor (mare)		130012-024
18	Capac pentru mosor (mediu) (2) (Una este montată pe mașină.)		XE1372-001
19	Capac pentru mosor (mic)		130013-124
20	Insertie mosor (mosor de format mini)		XA5752-121
21	Plasă de protecție mosor		XA5523-020
22	Dispozitiv de ridicare cu genunchiul		XA6941-052
23	Suveică (pe mașină)		XG2058-001
24	Pedală de control	XZ5098-001 (regiunea UE) XZ5100-001 (alte regiuni)	
25	Geantă pentru accesorii		XC4487-021
26	Casetă de transport		XG5628-001
27	Set de coli hârtie milimetrică		XC4549-020

*3 Modelul SA156 este o suveică de Clasa 15.

◆ Допълнителни аксесоари

Налични са следните допълнителни аксесоари, които могат да се закупят отделно от оторизирания дилър на Brother.

№	Наименование на частта	Код на частта	
		Северна и Южна Америка	Други
1	Краче за квилтване	SA129	F005N: XC1948-052
2	Движещо се краче	SA140	F033N: XC2214-052
3	Краче за квилтване, 1/4 инча	SA125	F001N: XC1944-052
4	Краче за квилтване с водач, 1/4 инча	SA185	F057: XC7416-252
5	Водач за квилтване	SA132	F016N: XC2215-052
6	Нож за странично рязане „S”	SA177	F054: XC3879-152
7	Отворено краче	SA186	F060: XE1094-101
8	Отворено краче за квилтване със свободно движение „O”	SA187	F061: XE1097-001
9	Незалепващо краче	SA114	F007N: XC1949-052
10	Краче за насочване на шва „P”	SA160	F035N: XC1969-052
11	Регулируемо краче за цип/ширити и кантове	SA161	F036N: XC1970-052
12	Краче за кожа и промазани матери	SA190	F066: XF1723-001
13	Краче за прав шев и комплект пластина на иглата	SA564 SA564C (Канада)	SNP02: XG0946-001 SNP02AP: XG0948-001
14	Широка маса	SAWT4	WT14: XG5051-001 WT14AP: XG4656-001

◆ Аксесоари опционално

Урмътоarele аксесоари са налични като опционални аксесоари, които могат да се закупят отделно от оторизирания дилър на Brother.

Nr. crt.	Denumire piesă	Cod piesă	
		America	Алте региони
1	Picioruș pentru matlasat	SA129	F005N: XC1948-052
2	Picioruș de deplasare	SA140	F033N: XC2214-052
3	Picioruș pentru matlasat 6,35 mm (1/4")	SA125	F001N: XC1944-052
4	Picioruș pentru matlasat 6,35 mm (1/4") cu ghidaj	SA185	F057: XC7416-252
5	Ghidaj pentru matlasat	SA132	F016N: XC2215-052
6	Tăietor lateral „S”	SA177	F054: XC3879-152
7	Picioruș cu deschidere	SA186	F060: XE1094-101
8	Picioruș pentru matlasat cu mișcare liberă, cu deschidere „O”	SA187	F061: XE1097-001
9	Picioruș antiaderent	SA114	F007N: XC1949-052
10	Picioruș de ghidare a cusăturii „P”	SA160	F035N: XC1969-052
11	Picioruș reglabil pentru fermoar/paspoal	SA161	F036N: XC1970-052
12	Picioruș cu rolă de ghidare	SA190	F066: XF1723-001
13	Set de picioruș pentru cusătură dreaptă și placă de ac	SA564 SA564C (Канада)	SNP02: XG0946-001 SNP02AP: XG0948-001
14	Masă lată	SAWT4	WT14: XG5051-001 WT14AP: XG4656-001



Bobbin Winding and Setting

Undertrådspoling og -innstilling

Undertrådsspölning och inställning

Opspoling af undertråd og indstilling

Puolaus ja puolan asettaminen

Navinutí a nasazení spodní cívky

Alsószál orsózása és beállítása

Nawijanie i ustawianie bębenka

Навиване и поставяне на калерчето

Înfășurarea și introducerea firului bobinei

Follow the steps below in numerical order. Refer to the Operation Manual for detailed instructions.
 Følg fremgangsmåten nedenfor i nummerrekkefølge. Du finner detaljerte instruksjer i Bruksanvisningen.
 Följ stegen nedan, i nummerordning. Se Bruksanvisningen för utförliga instruktioner.
 Følg nedenstående trin i numerisk rækkefølge. Se Brugsanvisningen for at få detaljerede instruktioner.
 Noudata alla annettuja vaiheita numerojärjestyksessä. Lisätietoja on Käyttöohjeessa.
 Postupujte podle níže uvedených kroků v pořadí podle čísel. Podrobné pokyny naleznete v Uživatelské příručce.
 Kövesse az alábbi lépéseket számsorrendben. A részletes utasításokért tekintse meg a Használati útmutatót.
 Wykonać poniższe kroki w kolejności oznaczonej numerami. Szczegółowe informacje można znaleźć w Instrukcji obsługi.
 Следвайте стъпките по-долу по реда на номерата. Вижте Ръководството за работа за подробни инструкции.
 Urmați pașii de mai jos, în ordinea indicată. Consultați Manual de utilizare pentru instrucțiuni detaliate.

Use only the included bobbin or bobbins of the same type.
 Bruk bare medfølgende spole eller spoler av samme type.
 Använd endast den medföljande spolen eller spolar av samma typ.
 Brug kun den medfølgende spole eller spoler af samme type.
 Käytä vain tämän koneen mukana toimitettuja puolia tai samantyyppisiä puolia.
 Používajte pouze priloženou cívku nebo cívky stejného typu.
 Csak a mellékelt orsót vagy ugyanolyan típusú orsókat használjon.
 Używać tylko dołączonego bębenka lub bębenków tego samego typu.
 Използвайте само включеното калерче или калерчета от същия тип.
 Utilizați numai bobina inclusă sau bobine de același tip.

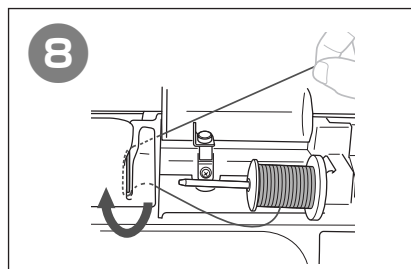
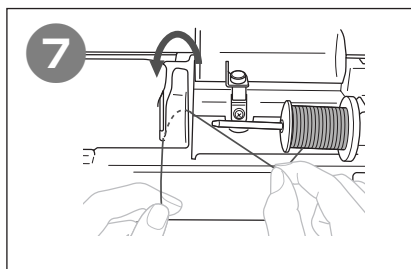
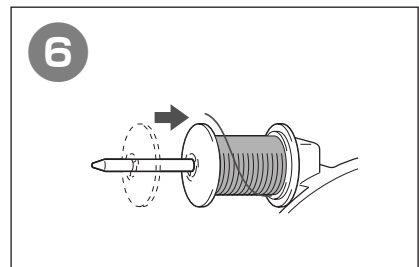
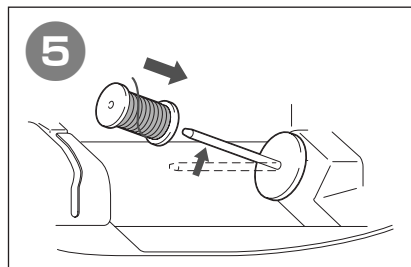
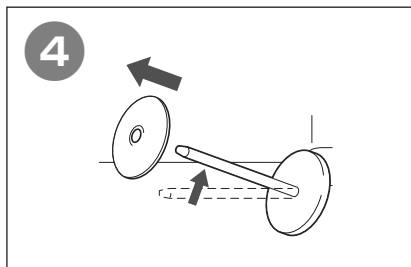
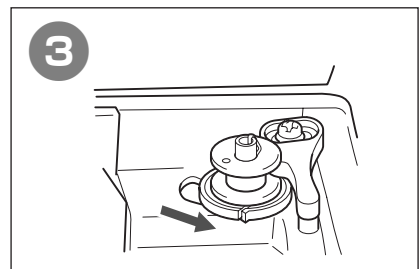
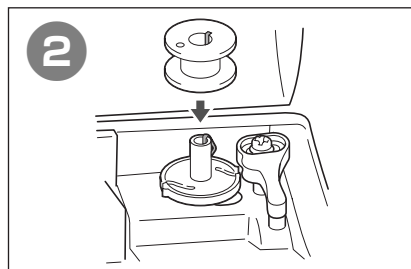
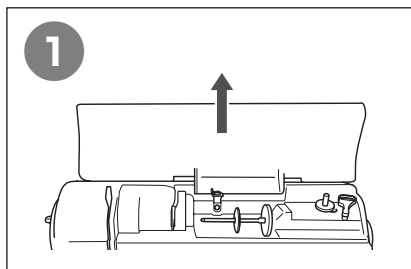
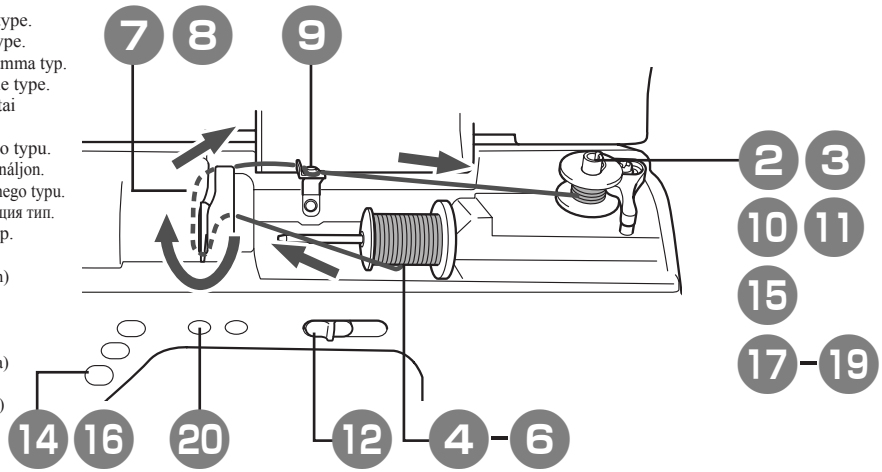
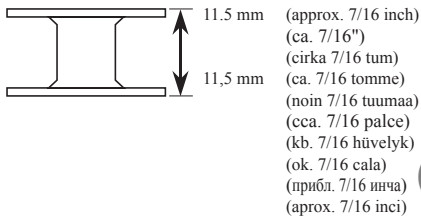

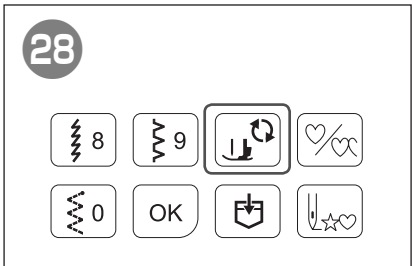
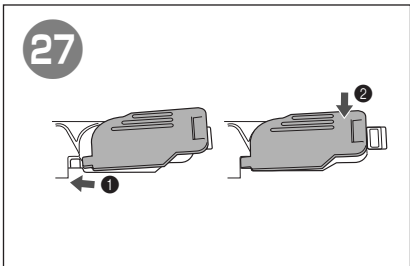
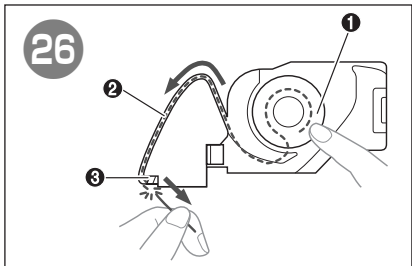
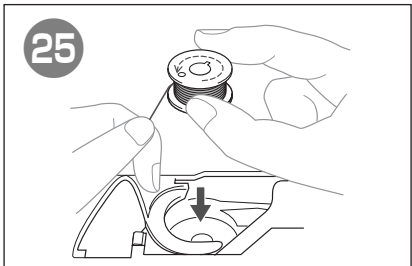
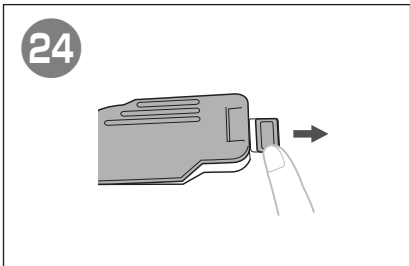
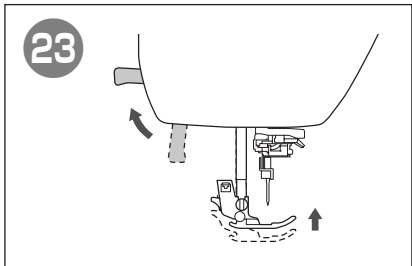
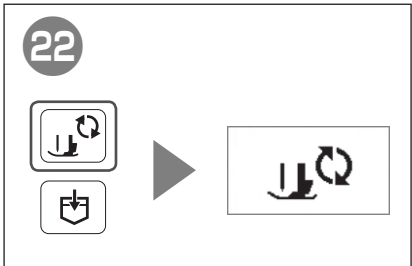
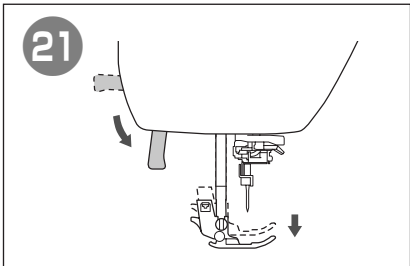
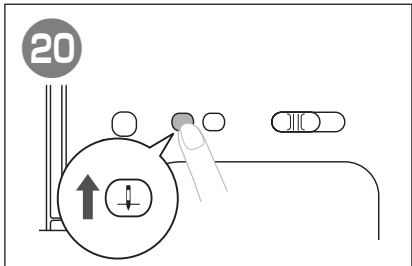
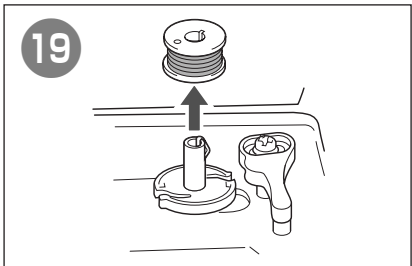
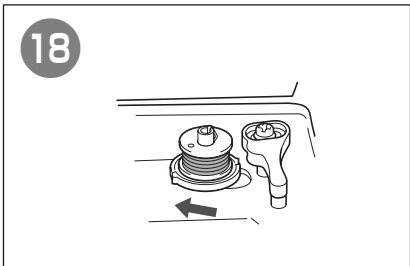
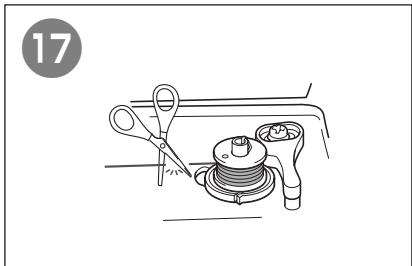
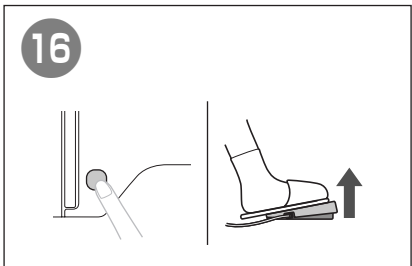
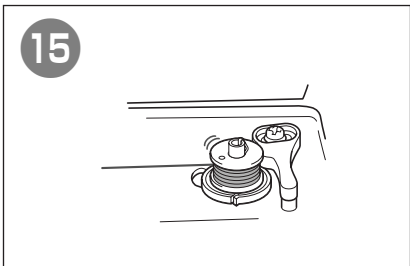
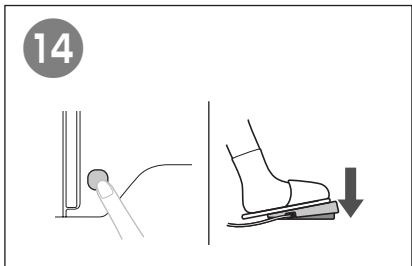
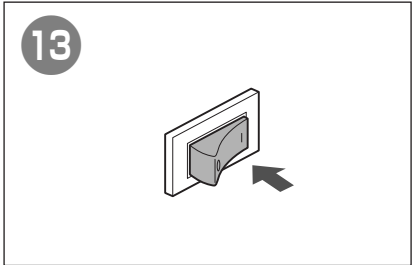
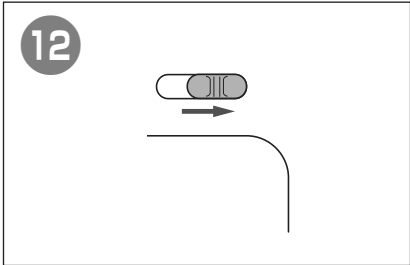
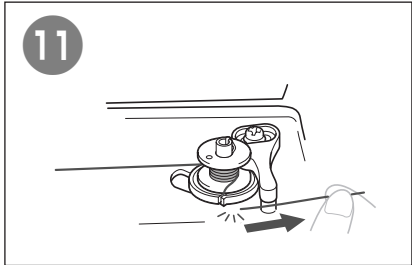
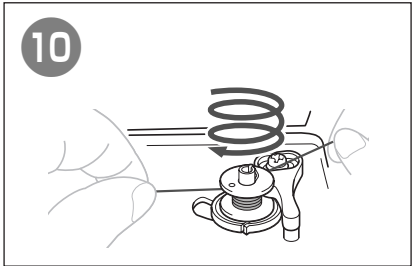
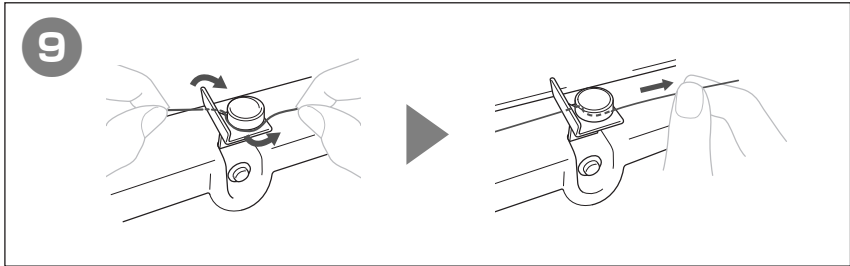

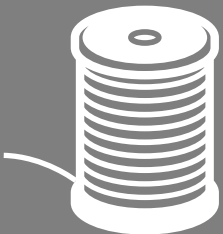

Upper Threading
Treing av övertråd
Trä övertråden
Trådning af övertråd
Ylälangan langoitus
Zavedení horní niti
Felsőszál befűzése
Nawlekanie górnej nici
Горно вдяване
Înfilarea firului superior

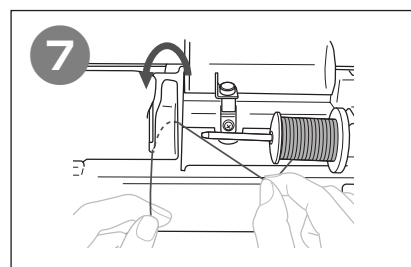
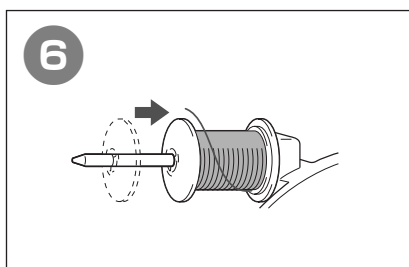
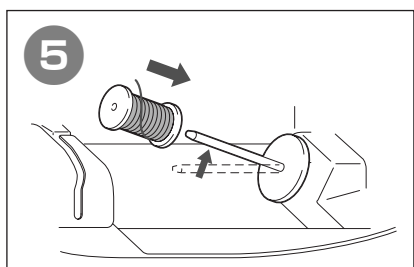
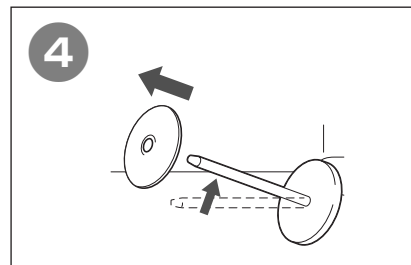
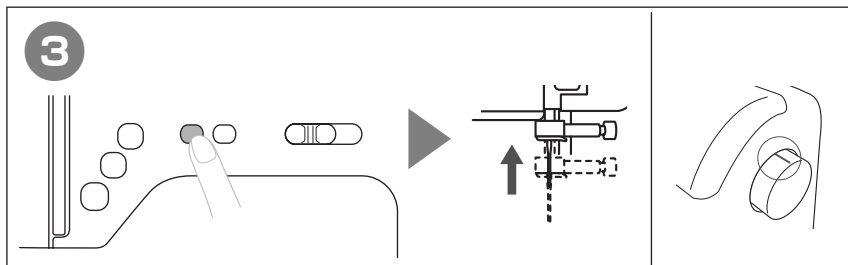
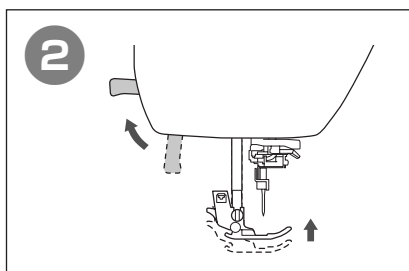
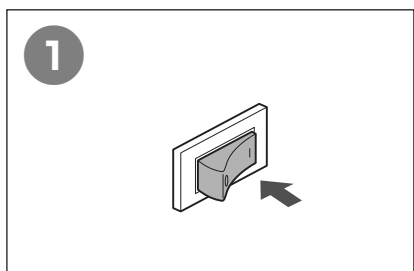
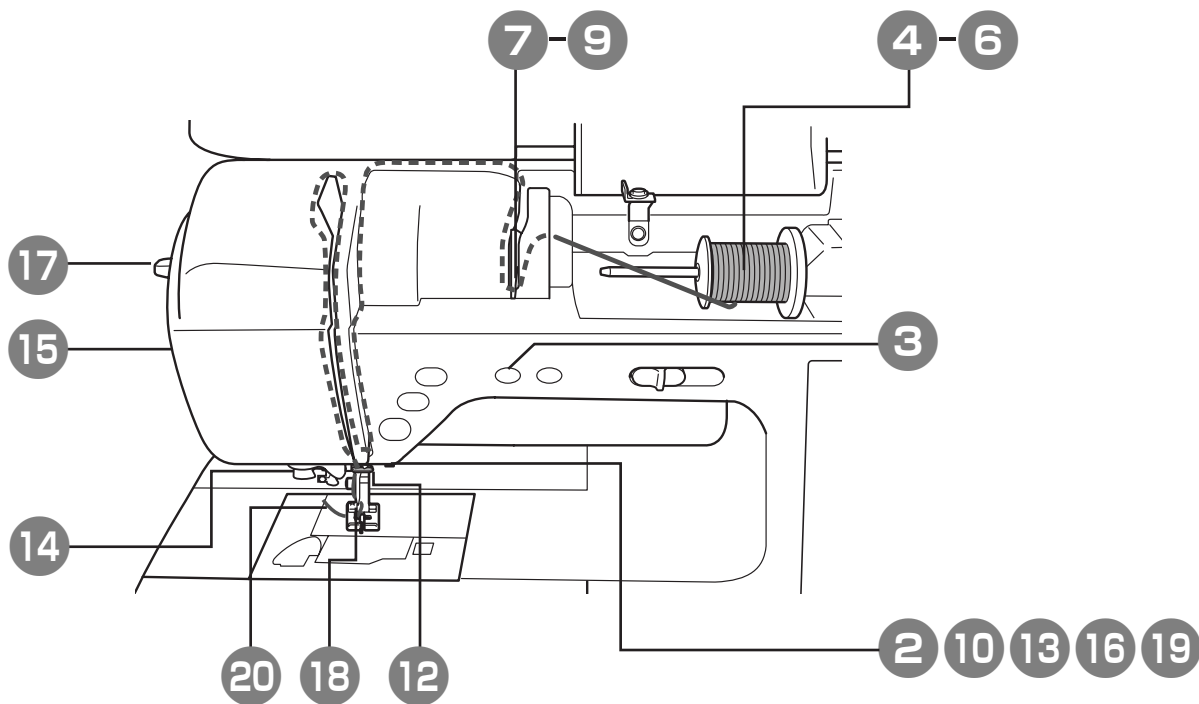

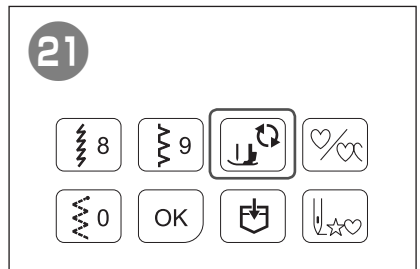
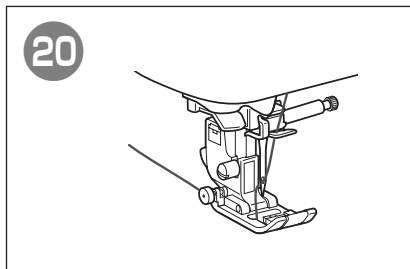
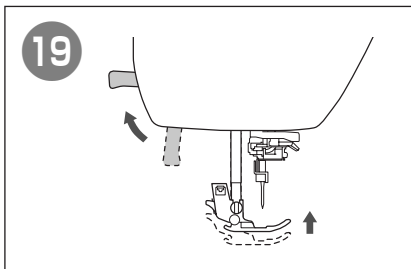
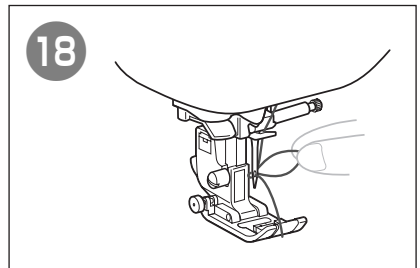
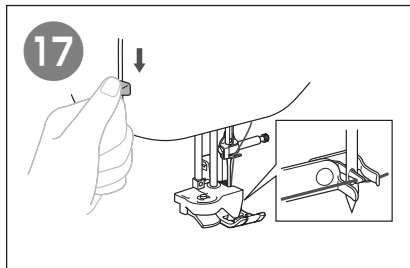
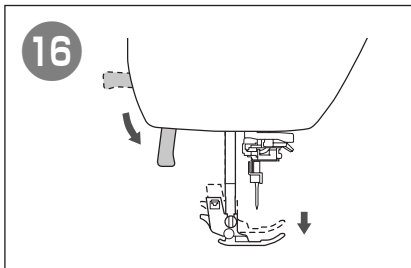
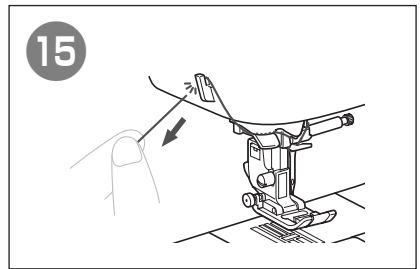
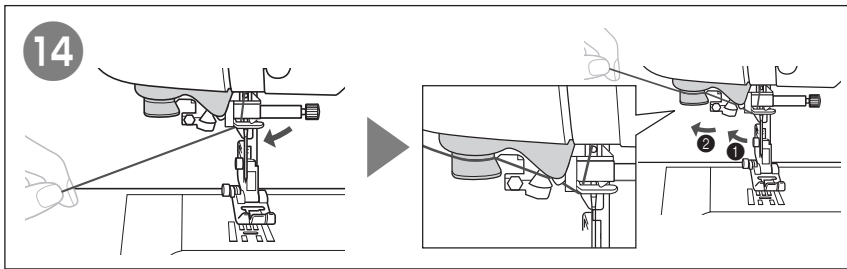
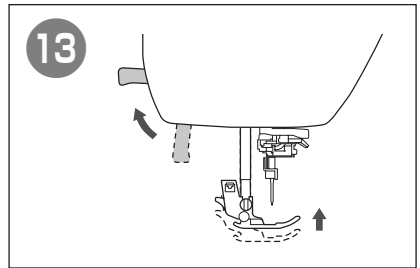
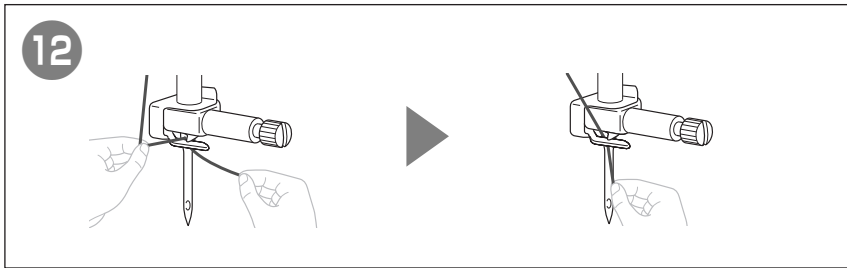
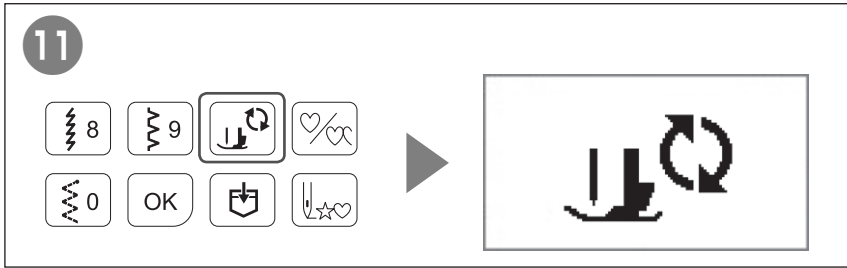
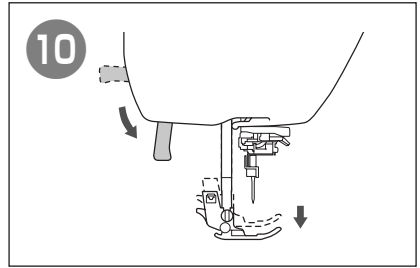
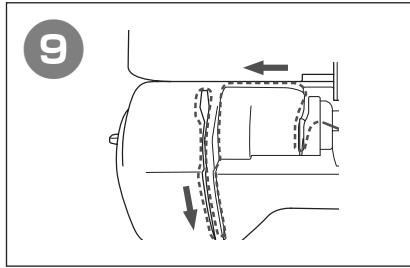
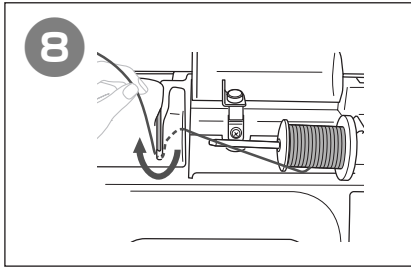

Selecting and Sewing Patterns
Velge og sy mønstre
Välja och sy mönster
Valg og syning af sømme
Ompeleiden valinta ja ompelu
Výběr vzorů a jejich šití
Minták kiválasztása és varrása
Wybór wzorów szycia
Избирание и шие на шаблони
Selectarea și brodarea modelelor

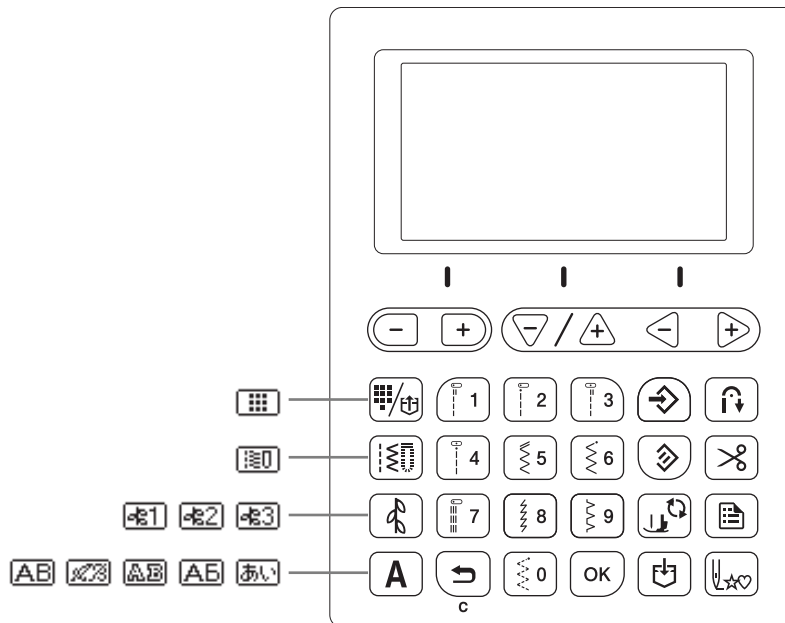

- ◆ Preset Utility Stitches
- ◆ Forhåndsinnstilte nyttesting
- ◆ Förinställda nyttsömmar
- ◆ Forudindstilte nyttesøm
- ◆ Esiasetetut hyötyompeleet
- ◆ Předvolba užítkových stehů
- ◆ Előbeállított haszonöltések
- ◆ Fabrycznie ustawione ściegi użytkowe
- ◆ Предварительно задани основни шевове
- ◆ Cusături utilitare presetate

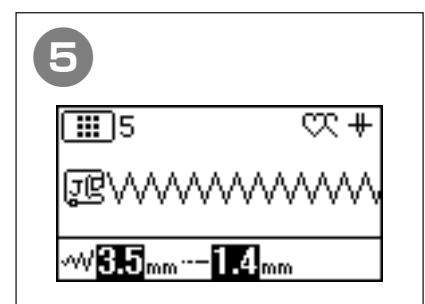
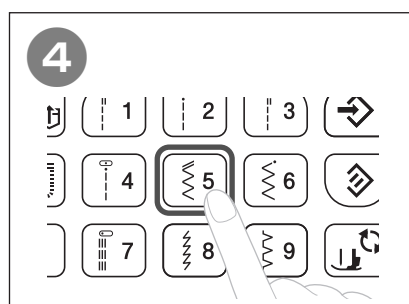
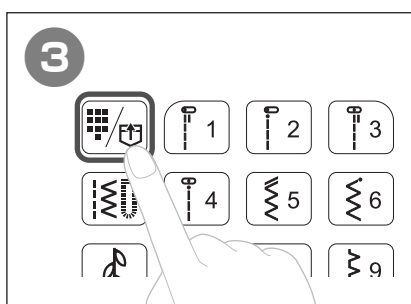
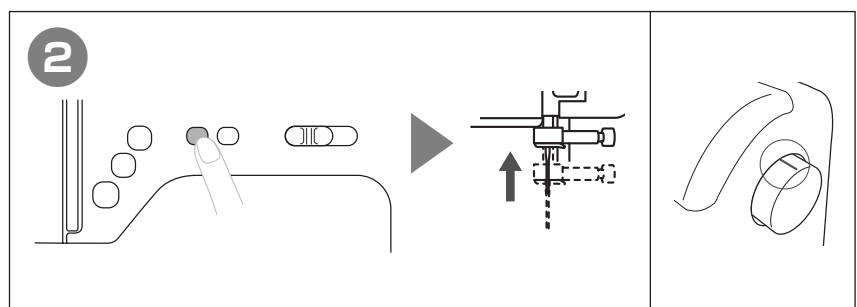
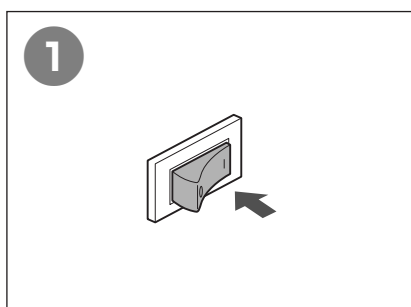

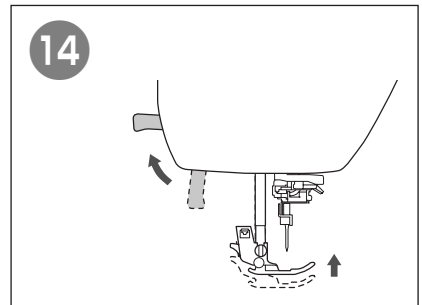
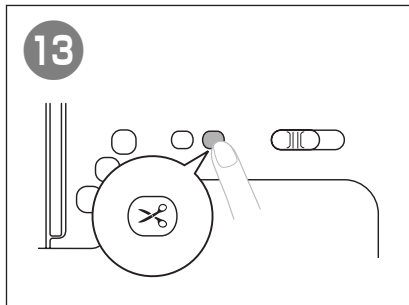
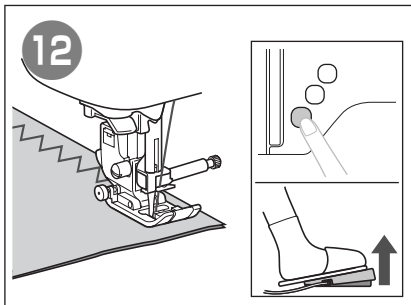
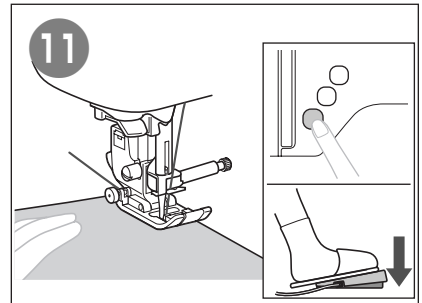
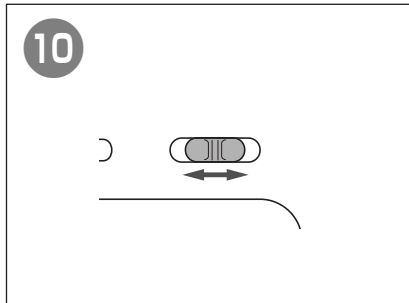
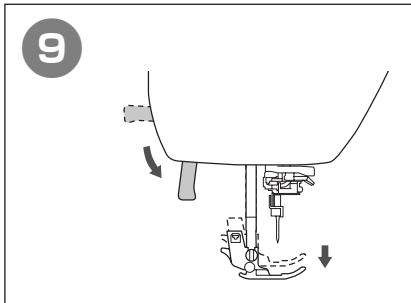
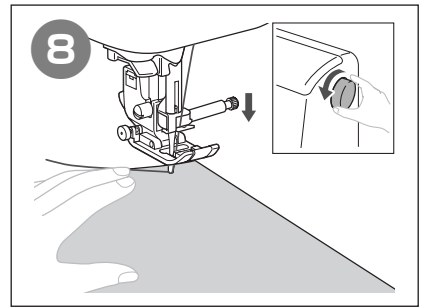
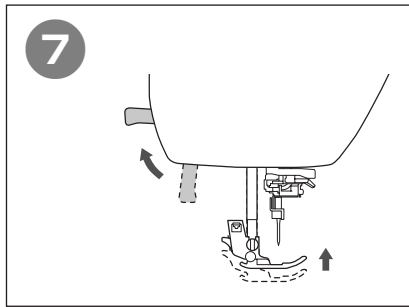
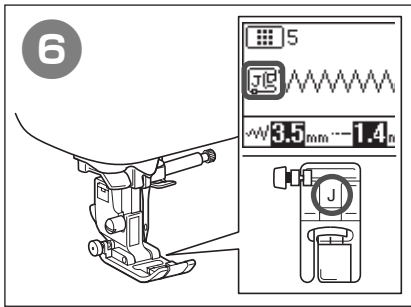

- ◆ Utility Stitches
- ◆ Hyötyompeleet
- ◆ Основни шевове

- ◆ Nyttesøm
- ◆ Užítkové stehy
- ◆ Cusături utilitare

- ◆ Nyttosömmar
- ◆ Haszonöltések

- ◆ Nyttesømme
- ◆ Ściegi użytkowe

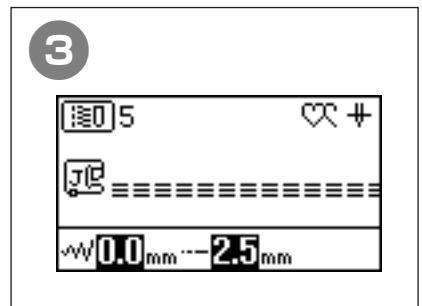
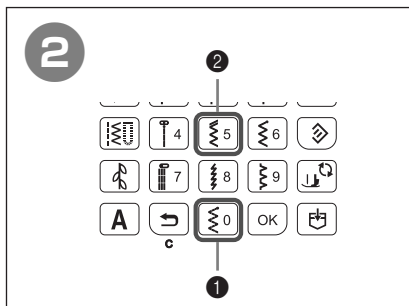
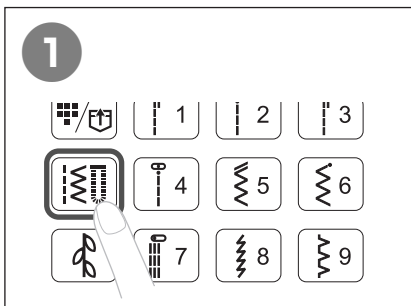

- ◆ Decorative Stitches
- ◆ Koristeompeleet
- ◆ Декоративни шевове

- ◆ Prydsøm
- ◆ Dekorativní stehy
- ◆ Cusături decorative

- ◆ Dekorativa sömmar
- ◆ Díszítőöltések

- ◆ Pyntesømme
- ◆ Ściegi dekoracyjne

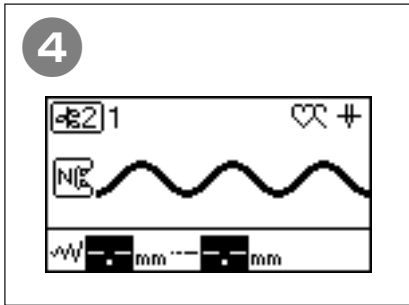
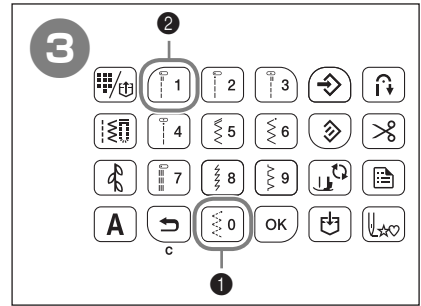
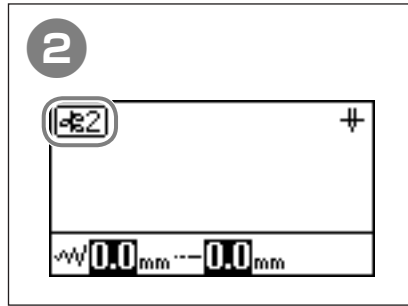
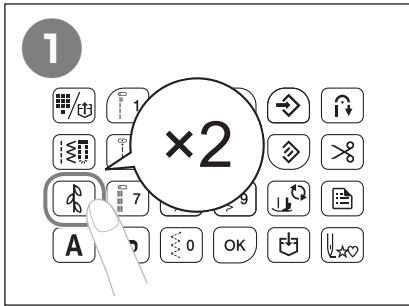

- ◆ Character stitches
- ◆ Kirjainmerkkiompeleet
- ◆ СИМВОЛНИ ШЕВОВЕ

- ◆ Tegnsøm
- ◆ Znakové stehy
- ◆ Cusături caractere

- ◆ Monogramsömmar
- ◆ Karakteröltések

- ◆ Alfabet
- ◆ Ściegi literowe

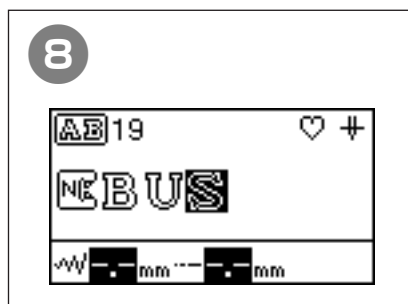
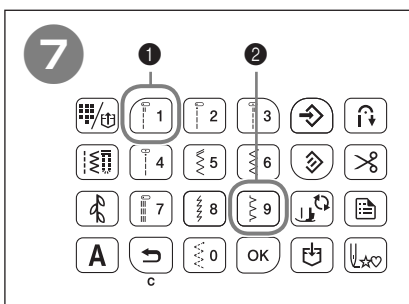
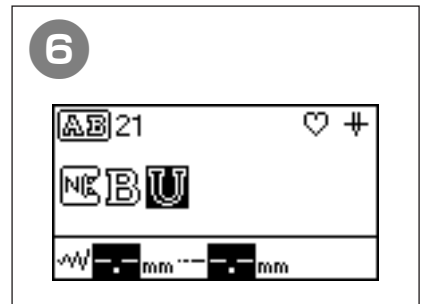
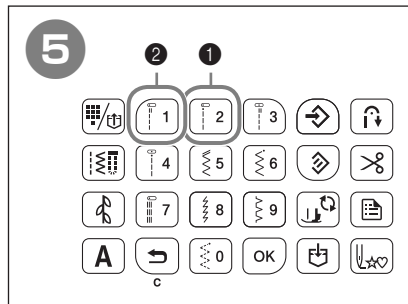
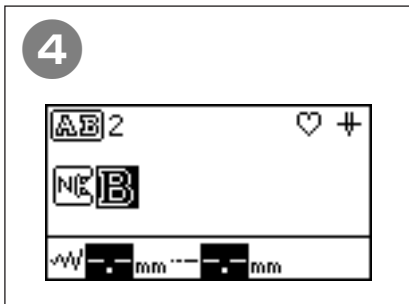
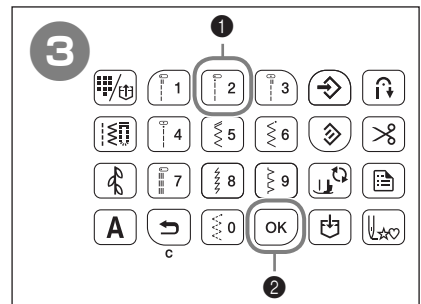
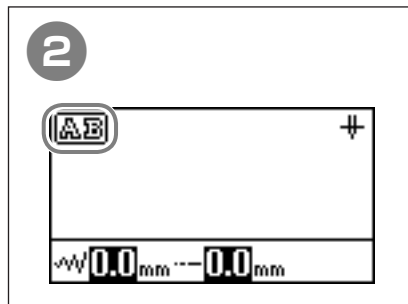
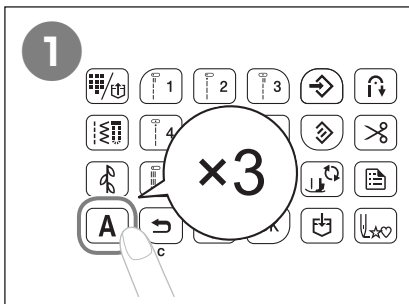



Summary of Stitch Patterns

Sammendrag av sømmønstre

Översikt över sömmar

Søm oversigt

Yhteenvedo ompeleista

Souhrn vzorů stehů

Az öltésminták összefoglalása

Podsumowanie wzorów ściegów

Обобщение на моделите шевовете

Modele de cusături

- ◆ Preset Utility Stitches
- ◆ Forhåndsinnstilte nyttesting
- ◆ Förinställda nyttosömmar
- ◆ Forudindstillede nyttesøm
- ◆ Esiasetetut hyötyompeleet
- ◆ Předvolba užítkových stehů
- ◆ Előbeállított haszonöltések
- ◆ Fabrycznie ustawione ściegi użytkowe
- ◆ Предварительно задани основни шевовете
- ◆ Cusături utilitare presetate



- ◆ Utility Stitches
- ◆ Nyttësøm
- ◆ Nyttösömmar
- ◆ Nyttësømme
- ◆ Hyötyompeleet
- ◆ Užítkové stehy
- ◆ Haszonöltések
- ◆ Ściegi użytkowe
- ◆ Основни шевовете
- ◆ Cusături utilitare

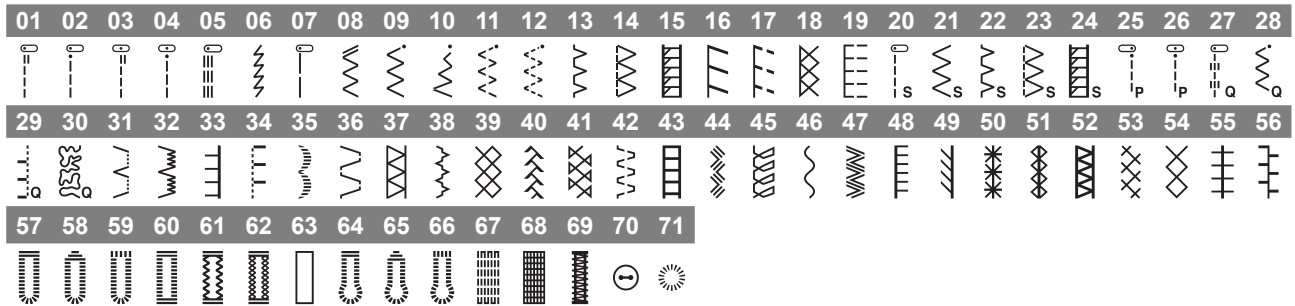

- ◆ Decorative Stitches
- ◆ Prydsøm
- ◆ Dekorativa sömmar
- ◆ Pyntesømme
- ◆ Koristeompeleet
- ◆ Dekorativní stehy
- ◆ Díszítőöltések
- ◆ Ściegi dekoracyjne
- ◆ Декоративни шевовете
- ◆ Cusături decorative



- Decorative Stitches
- Prydsøm
- Dekorativa sömmar
- Pyntesømme
- Koristeompeleet
- Dekorativní stehy
- Díszítőöltések
- Ściegi dekoracyjne
- Декоративни шевовете
- Cusături decorative

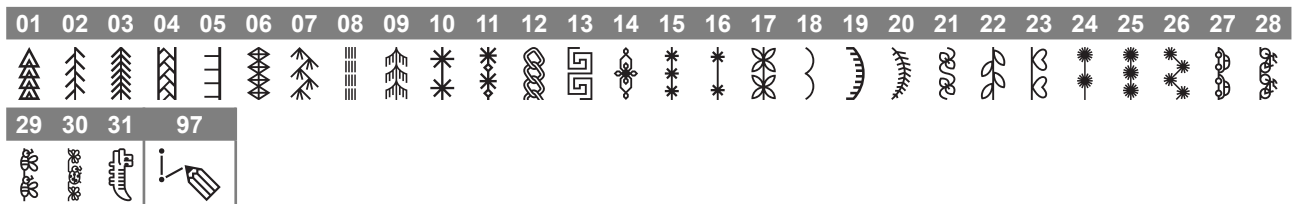

* 31: Pattern for making adjustment, 97: MY CUSTOM STITCH
 * 31: Mønster for justering, 97: MY CUSTOM STITCH (Mine egendefinerte sømmer)
 * 31: Mønster for att göra justering, 97: MY CUSTOM STITCH (Min egen søm)
 * 31: Mønster til at foretage justeringer, 97: My Custom Stitch
 * 31: Kuvio säätöä varten, 97: My Custom Stitch (oman pistokuvion suunnittelu)
 * 31: Vzorec pro nastavení 97: My Custom Stitch (Můj vlastní steh)
 * 31: minta beállításvégzéshez, 97: MY CUSTOM STITCH (Egyéni öltés)
 * 31: Wzór do poprawek, 97: My Custom Stitch (Mój własny ścieg)
 * 31: Модел за създаване на настройка, 97: МОЯТ ПЕРСОНАЛИЗИРАН ШЕВ
 * 31: Model pentru ajustare, 97: My Custom Stitch (Cusătura mea personalizată)



- Satin stitches (01-10)
7 mm satin stitches (11-27)
Cross stitch stitches (28-38)
- Laakaompeleet (01-10)
7 mm:n laakaompeleet (11-27)
Ristipisto-ompeleet (28-38)
- Сатенени шевове (01-10)
7 mm сатенени шевове (11-27)
Кръстатни шевове (28-38)

- Satengsting (01-10)
7 mm satengsting (11-27)
Korssting (28-38)
- Saténové stehy (01-10)
7 mm saténové stehy (11-27)
Křížové stehy (28-38)
- Cusături netede (01-10)
Cusături netede de 7 mm (11-27)
Cusături încrucișate (28-38)

- Plattsömmar (01-10)
7 mm plattsömmar (11-27)
Korsstygnsstyg (28-38)
- Szatén öltések (01-10)
7 mm-es szatén öltések (11-27)
Keresztöltésű öltések (28-38)

- Satinsting (01-10)
7 mm satinsting (11-27)
Korssting (28-38)
- Ściegi satynowe (01-10)
Ściegi satynowe 7 mm (11-27)
Ściegi krzyżkowe (28-38)



- * 98, 99: Pattern for step stitch
- * 98, 99: Kuvio porrastettujen ompeleiden tekemiseen
- * 98, 99: Модел за стъпков шев

- * 98, 99: Mønster for trappesting
- * 98, 99: Vzorac pro krokový stehu
- * 98, 99: Model pentru cusătură cu pași

- * 98, 99: Mønster för stegsöm
- * 98, 99: minta léptető öltéshez

- * 98, 99: Mønster til trappesting
- * 98, 99: Wzór ściegu krokowego



- Utility decorative stitch patterns
- Hyötykoristeompeleet
- Модели на основни декоративни шевове

- Dekorative stingtypemønstre
- Pracovní vzorce dekorativního stehu
- Modele de cusături decorative utile

- Mønster för dekorativ söm
- Haszondíszítőöltés-minták

- Dekorative brugsstingmønstre
- Wzory dekoracyjnych ściegów użytkowych

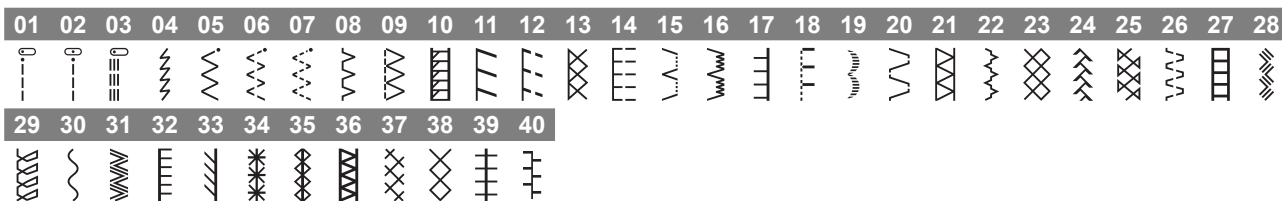

- ◆ Character stitches
- ◆ Kirjainmerkkiompeleet
- ◆ Символни шевове

- ◆ Tegnsøm
- ◆ Znakové stehy
- ◆ Cusături caractere

- ◆ Monogramsömmar
- ◆ Karakteröltések

- ◆ Alfabet
- ◆ Ściegi literowe

A x1 ► 

- Gothic font
- Gotisk skrift
- Teckensnitt Gotik
- Skriftypen Gothic
- Gootilainen kirjasin
- Gotický font
- Gótikus betűtípus
- Czcionka gotycka
- Готически шрифт
- Font gotic

1	2	3	4	5	6	7	8	9	10	11	12	13	14	15	16	17	18	19	20	21	22	23	24	25	26
A	B	C	D	E	F	G	H	I	J	K	L	M	N	O	P	Q	R	S	T	U	V	W	X	Y	Z
27	28	29	30	31	32	33	34	35	36	37	38	39	40	41	42	43	44	45	46	47	48	49	50	51	52
0	1	2	3	4	5	6	7	8	9	#	%	-	+	x	÷	=	*	.	,	&	?	!	@	<	>
53	54	55	56	57	58	59	60	61	62	63	64	65	66	67	68	69	70	71	72	73	74	75	76	77	78
()	[]	/	\	~	©	®	™	“	”	”	’	’	’	’	’	’	’	’	’	’	’	’	’
79	80																								
U	B																								

A x2 ► 

- Handwriting font
- Håndskrift
- Teckensnitt Handskrift
- Skriftypen Håndskrift
- Käsinkirjoitettu kirjasin
- Font rukopisu
- Kézírás-betűtípus
- Czcionka imitująca pismo ręczne
- Ръкописен шрифт
- Font pentru scris de mână

1	2	3	4	5	6	7	8	9	10	11	12	13	14	15	16	17	18	19	20	21	22	23	24	25	26
A	B	C	D	E	F	G	H	I	J	K	L	M	N	O	P	Q	R	S	T	U	V	W	X	Y	Z
27	28	29	30	31	32	33	34	35	36	37	38	39	40	41	42	43	44	45	46	47	48	49	50	51	52
0	1	2	3	4	5	6	7	8	9	#	%	-	+	x	÷	=	*	.	,	&	?	!	@	<	>
53	54	55	56	57	58	59	60	61	62	63	64	65	66	67	68	69	70	71	72	73	74	75	76	77	78
()	[]	/	\	~	©	®	™	“	”	”	’	’	’	’	’	’	’	’	’	’	’	’	’
79	80																								
U	B																								

A ×3 ▶ **AB**

- Outline
- Ääriivakirjasin
- Контур
- Kontur
- Obrys
- Contur
- Kontur
- Körvonal
- Outline
- Kontur

1	2	3	4	5	6	7	8	9	10	11	12	13	14	15	16	17	18	19	20	21	22	23	24	25	26
A	B	C	D	E	F	G	H	I	J	K	L	M	N	O	P	Q	R	S	T	U	V	W	X	Y	Z
27	28	29	30	31	32	33	34	35	36	37	38	39	40	41	42	43	44	45	46	47	48	49	50	51	52
0	1	2	3	4	5	6	7	8	9	#	%	-	+	x	÷	=	*	.	,	&	?	!	@	<	>
53	54	55	56	57	58	59	60	61	62	63	64	65	66	67	68	69	70	71	72	73	74	75	76	77	78
()	[]	/	\	~	©	®	™	“	”	”	’	‘	’	_	Ä	Å	Æ	Ç	Ð	Ñ	Ö	Ø	Œ
79	80																								
Ù	Û																								

A ×4 ▶ **AB**

- Cyrillic font
- Kyrillinen kirjasin
- Шрифт на кирилица
- Kyrillisk skrift
- Azbukový font
- Font chirilic
- Kyrilliskt teckensnitt
- Cirill betüttípus
- Skriftypen Kyrillisk
- Curylica

1	2	3	4	5	6	7	8	9	10	11	12	13	14	15	16	17	18	19	20	21	22	23	24	25	26	
А	Б	В	Г	Д	Е	Ё	Ж	З	И	Й	К	Л	М	Н	О	П	Р	С	Т	У	Ф	Х	Ц	Ч	Ш	
27	28	29	30	31	32	33	34	35	36	37	38	39	40	41	42	43	44	45	46	47	48	49	50	51	52	
Щ	Ъ	Ы	Ь	Э	Ю	Я	Г	Є	І	Ї	Ў	Ғ	Ң	Ҥ	Ҧ	Ҩ	Ҫ	Ҭ	Ү	Ұ	Қ	О	1	2	3	4
53	54	55	56	57	58	59	60	61	62	63	64	65	66	67	68											
5	6	7	8	9	-	.	,	&	?	!	()	/	'	_											

- Example of Kanji characters in daily life
- Eksempel på dagligdagse kanji-tegn
- Exempel på Kanji-tecken som används för dagligt bruk
- Eksempel på Kanji-tegn i hverdagen
- Esimerkki kanji-merkeistä arkielämässä
- Příklad znaků kandži v každodenním životě
- Példa a mindennapokban használt kandzsi karakterekre
- Przykłady znaków Kanji w życiu codziennym
- Примери на йероглифи канджи в ежедневието
- Exemple de caractere Kanji în viața de zi cu zi

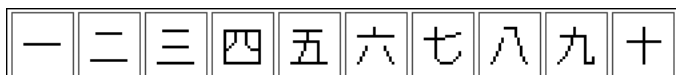

1, 2, 3, 4, 5, 6, 7, 8, 9, 10

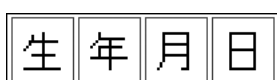

Date of birth
Syntymäaika
Дата на раждане

Fødselsdato
Datum narození
Data nașterii

Födelsedatum
Születési idő

Fødselsdato
Data urodzenia

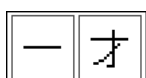

1 year old
1-vuotias
Възраст 1 година

1 år gammel
1 rok starý
1 an

1 år gammal
1 éves

1 år gammel
1 rok

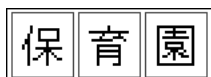

Nursery school
Päiväkoti
Ясла

Barnehage
Jesle
Creșă

Daghem
Bölcsőde

Vuggestue
Žlobek

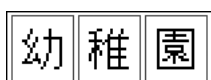

Kindergarten
Lastentarha
Детска градина

Førskole
Školka
Grădiniță

Förskola
Óvoda

Børnehave
Przedszkole

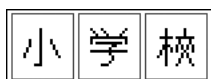

Elementary school
Ala-aste
Начално училище

Barneskole
Základní škola
Școală primară

Grundskola
Általános iskola

Grundskole
Szkoła podstawowa

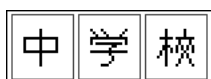

Junior high school
Yläaste
Средно училище

Ungdomsskole
Střední škola
Gimnaziu

Högstadiet
Középiskola

7.-9. skoleår
Szkoła średnia



Group/Class
Ryhmä/luokka
Група/клас

Gruppe/klasse
Skupina/Třída
Grupă/Clasă

Grupp/klasse
Csoport/osztály

Gruppe/klasse
Grupa/klasa



Club/Division
Yhdistys/jaosto
Клуб/отдел

Klubb/divisjon
Klub/Oddfil
Club/Divizie

Klubb/division
Klub/részleg

Klub/division
Klub/oddział



Moon/Monday
Kuu/maanantai
Луна/понеделик

Måne/mandag
Měsíc/Pondělí
Lună/Luni

Måne/Måndag
Hold/hétfő

Måne/mandag
Księżyc/poniedziałek



Fire/Tuesday
Tuli/tiistai
Огън/вторник

Brann/tirsdag
Oheň/Úterý
Foc/Marți

Eld/Tisdag
Tűz/kedd

Ild/tirsdag
Ogień/wtorek



Water/Wednesday
Vesi/keskiviikko
Вода/среда

Vann/onsdag
Voda/Středa
Apă/Miercuri

Vatten/Onsdag
Víz/szerda

Vand/onsdag
Woda/środa



Tree/Thursday
Puu/torstai
Дърво/четвъртък

Tre/torsdag
Strom/Čtvrtek
Arbore/Joi

Träd/Torsdag
Fa/csütörtök

Træ/torsdag
Drzewo/czwartek



Gold/Friday
Kulta/perjantai
Злато/петък

Gull/fredag
Zlato/Pátek
Aur/Vineri

Guld/Fredag
Arany/péntek

Guld/fredag
Zloto/piątek



Soil/Saturday
Maa/lauantai
Земля/събота

Jord/lørdag
Země/Sobota
Pământ/Sâmbătă

Jord/Lördag
Föld/szombat

Jord/lordag
Ziemia/sobota



Sun/Sunday
Aurinko/sunnuntai
Слънце/неделя

Sol/søndag
Slunce/Neděle
Soare/Duminică

Sol/Söndag
Nap/vasárnap

Sol/søndag
Słońce/niedziela



January 1st (Monday)
1. tammikuuta (maanantai)
1 января (понеделик)

1. januar (mandag)
1. ledna (pondělí)
1 Ianuarie (luni)

1 januari (måndag)
Január 1. (hétfő)

1. januar (mandag)
1 stycznia (poniedziałek)

English
Norwegian
Swedish
Danish
Finnish
Czech
Hungarian
Polish
Bulgarian
Romanian
888H72
Printed in Vietnam



XG7122-101①