



View this machine and more at:

<https://www.thesewingstudio.co.uk>

Operation Manual

Sewing Machine

Product Code: 888-M50/M60/M62/M63

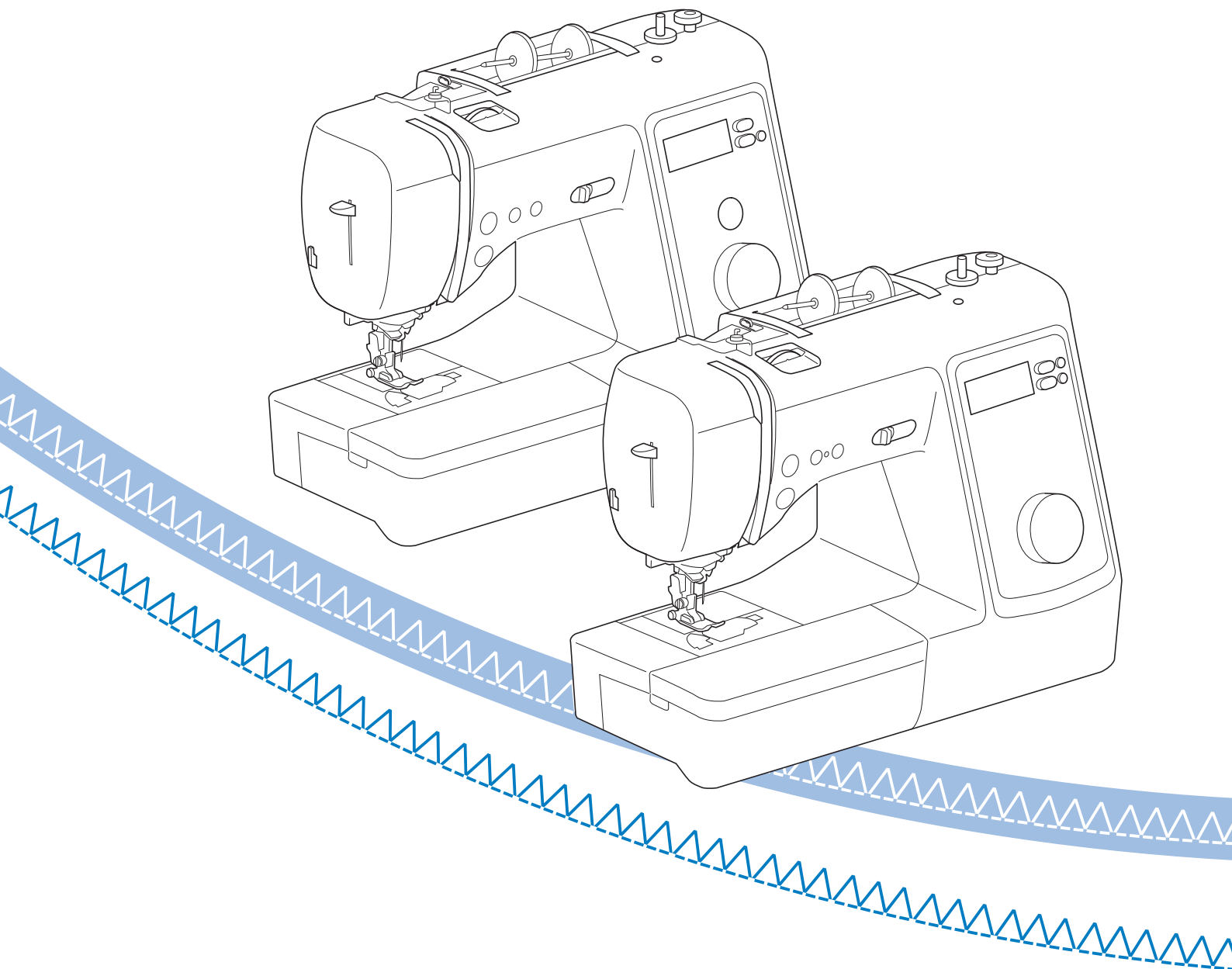

Be sure to read this document before using the machine.
We recommend that you keep this document nearby for future reference.

INTRODUCTION

Thank you for purchasing this machine. Before using this machine, carefully read the "IMPORTANT SAFETY INSTRUCTIONS", and then study this manual for the correct operation of the various functions. In addition, after you have finished reading this manual, store it where it can quickly be accessed for future reference.

IMPORTANT SAFETY INSTRUCTIONS

Please read these safety instructions before attempting to use the machine.

DANGER

- To reduce the risk of electrical shock

- 1** Always unplug the machine from the electrical outlet immediately after using, when cleaning, making any user servicing adjustments mentioned in this manual, or if you are leaving the machine unattended.

WARNING

- To reduce the risk of burns, fire, electrical shock, or injury to persons.

- 2** Always unplug the machine from the electrical outlet when making any adjustments mentioned in the instruction manual.

- To unplug the machine, switch the machine to the symbol "O" position to turn it off, then grasp the plug and pull it out of the electrical outlet. Do not pull on the cord.
- Plug the machine directly into the electrical outlet. Do not use an extension cord.
- Always unplug your machine if there is a power failure.

- 3** Electrical Hazards:

- This machine should be connected to an AC power source within the range indicated on the rating label. Do not connect it to a DC power source or converter. If you are not sure what kind of power source you have, contact a qualified electrician.

- This machine is approved for use in the country of purchase only.

- 4** Never operate this machine if it has a damaged cord or plug, if it is not working properly, has been dropped or damaged, or water is spilled on the unit. Return the machine to the nearest authorized Brother dealer for examination, repair, electrical or mechanical adjustment.

- While the machine is stored or in use if you notice anything unusual, such as an odor, heat, discoloration or deformation, stop using the machine immediately and unplug the power cord.
- When transporting the machine, be sure to carry it by its handle. Lifting the machine by any other part may damage the machine or result in the machine falling, which could cause injuries.
- When lifting the machine, be careful not to make any sudden or careless movements, which may cause a personal injury.

- 5** Always keep your work area clear:

- Never operate the machine with any air openings blocked. Keep ventilation openings of the machine and foot control free from the build up of lint, dust, and loose cloth.
- Do not store objects on the foot controller.
- Never drop or insert foreign objects in any opening.
- Do not operate where aerosol (spray) products are being used or where oxygen is being administered.
- Do not use the machine near a heat source, such as a stove or iron; otherwise, the machine, power cord or garment being sewn may ignite, resulting in fire or an electric shock.
- Do not place this machine on an unstable surface, such as an unsteady or slanted table, otherwise the machine may fall, resulting in injuries.

- 6** Special care is required when sewing:

- Always pay close attention to the needle. Do not use bent or damaged needles.
- Keep fingers away from all moving parts. Special care is required around the machine needle.
- Switch the machine to the symbol "O" position to turn it off when making any adjustments in the needle area.
- Do not use a damaged or incorrect needle plate, as it could cause the needle to break.
- Do not push or pull the fabric when sewing, and follow careful instruction when free motion stitching so that you do not deflect the needle and cause it to break.

7 This machine is not a toy:

- Your close attention is necessary when the machine is used by or near children.
- The plastic bag that this machine was supplied in should be kept out of the reach of children or disposed of. Never allow children to play with the bag due to the danger of suffocation.
- Do not use outdoors.

8 For a longer service life:

- When storing this machine, avoid direct sunlight and high humidity locations. Do not use or store the machine near a space heater, iron, halogen lamp, or other hot objects.
- Use only neutral soaps or detergents to clean the case. Benzene, thinner, and scouring powders can damage the case and machine, and should never be used.
- Always consult the Operation Manual when replacing or installing any assemblies, the presser feet, needle or other parts to assure correct installation.

9 For repair or adjustment:

- If the light unit is damaged, it must be replaced by an authorized Brother dealer.
- In the event a malfunction occurs or adjustment is required, first follow the troubleshooting table in the back of the Operation Manual to inspect and adjust the machine yourself. If the problem persists, please consult your local authorized Brother dealer.

Use this machine only for its intended use as described in the manual.

Use accessories recommended by the manufacturer as contained in this manual.

The contents of this manual and specifications of this product are subject to change without notice.

For additional product information and updates, visit our website at www.brother.com

SAVE THESE INSTRUCTIONS

This machine is intended for household use.

FOR USERS IN COUNTRIES EXCEPT CENELEC COUNTRIES

This appliance is not intended for use by persons (including children) with reduced physical, sensory or mental capabilities, or lack of experience and knowledge, unless they have been given supervision or instruction concerning use of the appliance by a person responsible for their safety. Children should be supervised to ensure that they do not play with the appliance.

FOR USERS IN CENELEC COUNTRIES

This appliance can be used by children aged from 8 years and above and persons with reduced physical, sensory or mental capabilities or lack of experience and knowledge if they have been given supervision or instruction concerning use of the appliance in a safe way and understand the hazards involved. Children shall not play with the appliance. Cleaning and user maintenance shall not be made by children without supervision.

FOR USERS IN THE UK, EIRE, MALTA AND CYPRUS ONLY

IMPORTANT

- In the event of replacing the plug fuse, use a fuse approved by ASTA to BS 1362, i.e. carrying the  mark, rating as marked on plug.
- Always replace the fuse cover. Never use plugs with the fuse cover omitted.
- If the available electrical outlet is not suitable for the plug supplied with this equipment, you should contact your authorized Brother dealer to obtain the correct lead.

Trademarks

App Store is a service mark of Apple Inc.
Android and Google Play are trademarks of Google, Inc.
Use of these trademarks are subject to Google Permissions.

CONTENTS

Chapter 1 GETTING READY	5	Chapter 4 APPENDIX	55
Names of Machine Parts	5	Care and Maintenance	55
Included accessories	7	Restrictions on oiling	55
Optional accessories	8	Precautions on storing the machine	55
Attaching the stitch pattern plate (For models equipped with the stitch pattern plate)	8	Cleaning the race.....	55
Turning the Machine On/Off	9	Troubleshooting	57
LCD Operation	10	Upper thread tightened up.....	57
Changing the Machine Settings	11	Tangled thread on wrong side of fabric.....	57
Winding/Installing the Bobbin	12	Incorrect thread tension	58
Winding the bobbin	12	Fabric is caught in the machine and cannot be removed	59
Installing the bobbin.....	14	If the thread becomes tangled under the bobbin winder seat.....	61
Upper Threading	15	List of symptoms	61
Threading the upper thread	15	Error messages	65
Pulling up the bobbin thread	18	Operation beeps	65
Fabric/Thread/Needle Combinations	19	Index	66
Replacing the Needle	20		
Checking the needle.....	20		
Replacing the needle.....	20		
Replacing the Presser Foot	21		
Replacing the presser foot	21		
Removing and attaching the presser foot holder	22		
Chapter 2 SEWING BASICS	23		
Sewing	23		
Basic sewing	23		
Sewing reverse/reinforcement stitches	25		
Automatic reverse/reinforcement stitching.....	25		
Reinforcement priority.....	27		
Setting the stitch width/stitch length	27		
Adjusting the thread tension	27		
Useful Sewing Tips	28		
Sewing Tips.....	28		
Sewing an even seam allowance	29		
Sewing Various Fabrics	30		
Sewing decorative stitch patterns.....	32		
Chapter 3 VARIOUS STITCHES	33		
Stitch Chart	33		
Utility stitches	38		
Overcasting Stitches	38		
Blind Hem Stitching	39		
Buttonhole sewing.....	40		
Button sewing	43		
Zipper Insertion.....	44		
Appliqué, Patchwork and Quilt Stitching.....	45		
Other Stitching Applications.....	49		
Making adjustments (For 80/60/50 stitches models)	54		

Chapter 1 GETTING READY

Names of Machine Parts

■ Main parts

The appearance of the machine differs depending on the model.

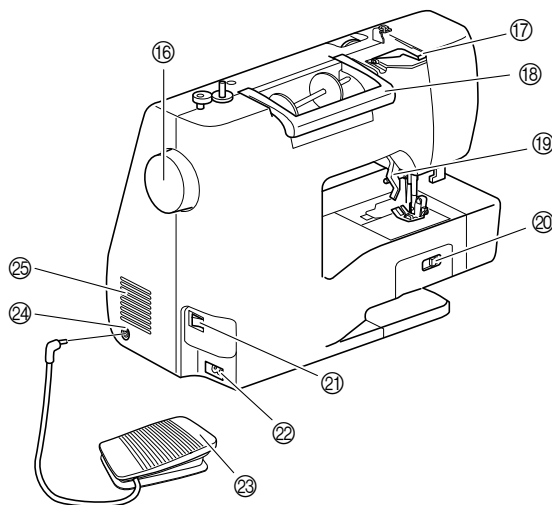
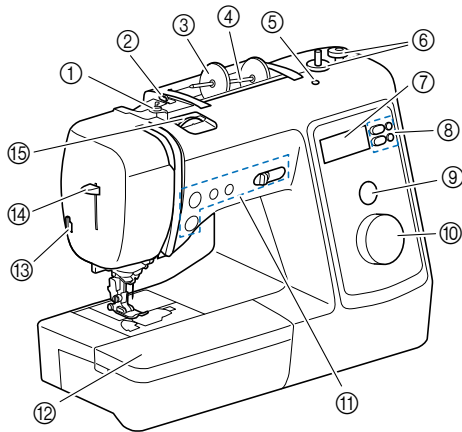

- ① **Bobbin winding thread guide and pretension disk (page 13)**
- ② **Thread guide (page 13)**
- ③ **Spool cap (page 12)**
- ④ **Spool pin (page 12)**
- ⑤ **Hole for extra spool pin**
This holds an extra spool pin for sewing with the twin needle. (page 52) This is not a hole for lubrication. Do not insert oil into this hole.
- ⑥ **Bobbin winder (page 12)**
- ⑦ **LCD (liquid crystal display) (page 10)**
- ⑧ **Operation keys (page 6)**
The operation keys differ depending on the model.
- ⑨ **Stitch pattern display window (page 23)**
(Equipped on 16 stitches model)
- ⑩ **Stitch pattern selection dial (page 23)**
- ⑪ **Operation buttons and sewing speed controller (page 6)**
- ⑫ **Flat bed attachment (page 7, 29)**
- ⑬ **Thread cutter (page 17)**
- ⑭ **Needle threader lever (page 17)**

- ⑮ **Thread tension dial (page 27)**

- ⑯ **Handwheel**

Turn the handwheel toward you (counterclockwise) to raise and lower the needle to sew one stitch.

- ⑰ **Thread guide cover (page 13)**

- ⑱ **Handle**

Carry the machine by its handle when transporting.

- ⑲ **Presser foot lever**

Raise and lower the presser foot lever to raise and lower the presser foot.

- ⑳ **Feed dog position switch**

Use the feed dog position switch to raise and lower the feed dogs. (page 48)

- ㉑ **Main power switch (page 9)**

- ㉒ **Power supply jack (page 9)**

- ㉓ **Foot controller (page 24)**

- ㉔ **Foot controller jack (page 24)**

- ㉕ **Air vent**

The air vent allows the air surrounding the motor to circulate. Do not cover the air vent while the machine is being used.

■ Needle and presser foot section

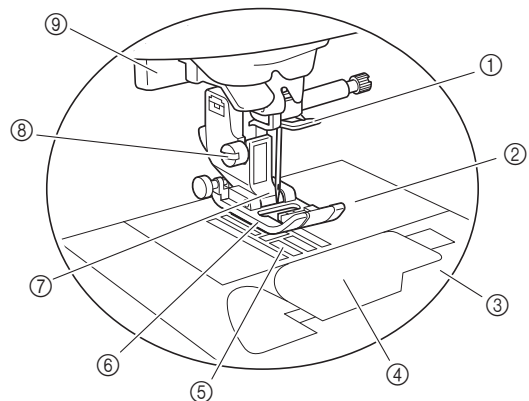

- ① **Needle bar thread guide (page 16)**
- ② **Needle plate (page 29)**
- ③ **Needle plate cover (page 14)**
- ④ **Bobbin cover/bobbin case (page 14, 56)**
- ⑤ **Feed dogs**
The feed dogs feed the fabric in the sewing direction.
- ⑥ **Presser foot**
The presser foot applies pressure consistently on the fabric as the sewing takes place. Attach the appropriate presser foot for the selected stitch.
- ⑦ **Presser foot holder (page 22)**
- ⑧ **Presser foot holder screw (page 22)**
- ⑨ **Buttonhole lever (page 42)**

■ Operation buttons

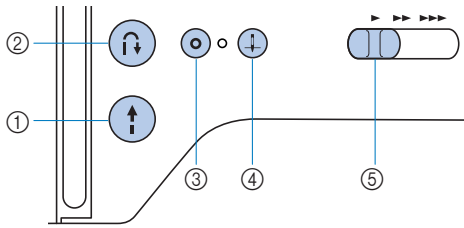

- ① **“Start/Stop” button** Press the “Start/Stop” button to start or stop sewing.
- ② **Reverse stitch button** Press the reverse button to sew reverse or reinforcement stitches depending on the selected stitch pattern.
- ③ **Reinforcement stitch button** Press the reinforcement button to sew a single stitch repeatedly and tie-off. (page 25)
For decorative stitches, press this button to end with a full stitch instead of at a mid-point.
The LED beside the button automatically lights up while the stitch is being sewn and goes off when sewing is finished. (For models equipped with the LED)
- ④ **Needle position button** Press the needle position button to raise or lower the needle.
Pressing the button twice sews one stitch.
- ⑤ **Sewing speed controller**
Slide the sewing speed controller to adjust the sewing speed.

■ Operation panel and operation keys

The appearance of the machine differs depending on the model.

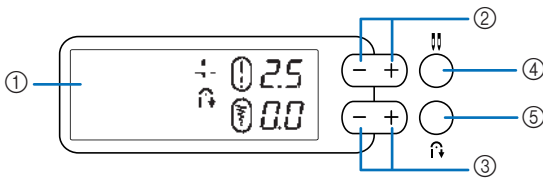

- ① **LCD (liquid crystal display)**
Selected stitch pattern settings and messages are displayed. (page 10)
- ② **Stitch length keys** Press the stitch length keys to adjust the stitch length. (page 27)
- ③ **Stitch width keys** Press the stitch width keys to adjust the stitch width. (page 27)
- ④ **Needle mode selection key (single/twin)**
(Equipped on 80/60/50 stitches models)
Press the needle mode selection key to use the twin needle.
Each press of this key switches between the twin needle mode and the single needle mode. (page 52)
- ⑤ **Automatic reverse/reinforcement key** Press the automatic reverse/reinforcement key to use the automatic reverse/reinforcement stitching function. (page 25)







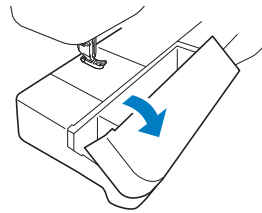



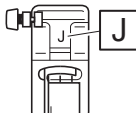
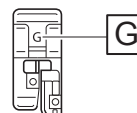
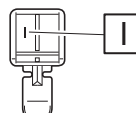
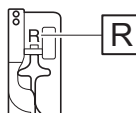
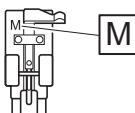

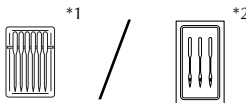
Included accessories

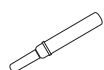
Included accessories may differ from the table below depending on the machine model you purchased. For more details on included accessories and their part codes of your machine, refer to the additional sheet "Included Accessories".

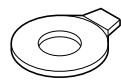
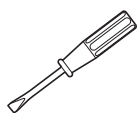
Pull the top of the flat bed attachment to open the accessory compartment.

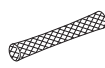

Included accessories

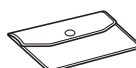
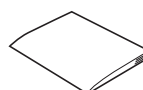
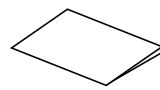

1.  Zigzag foot "J" (on machine)	2.  Overcasting foot "G"	3.  Zipper foot "I"	4.  Blind stitch foot "R"	5.  Button fitting foot "M"	6.  Buttonhole foot "A"
7.  Needle set (A needle set of the two is included with this machine.)	8.  Twin needle 2/11 needle	9.  Bobbin (4) (One bobbin is on machine.)	10.  Seam ripper	11.  Cleaning brush	
12.  Disc-shaped screwdriver	13.  Screwdriver (large)	14.  Extra spool pin	15.  Spool cap (large)	16.  Spool cap (medium) (on machine)	17.  Spool cap (small)
18.  Spool net	19.  Bobbin case (on machine)	20.  Foot controller	21.  Accessory bag	22.  Operation Manual	23.  Quick Reference Guide

*1 75/11 2 needles, 90/14 2 needles, 90/14 2 needles: Ball point needle (gold colored)
*2 75/11 1 needle, 90/14 1 needle, 100/16 1 needle

Note

- (For U.S.A. only) Foot controller: Model T
This foot controller can be used on the machine with product code 888-M50/M60/M62/M63. The product code is mentioned on the machine rating plate.

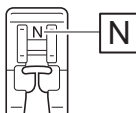
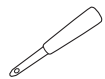
Accessories included depending on the model

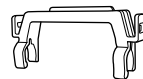
1.  Monogramming foot "N"	2.  Eyelet punch	3.  Screwdriver (small)	4.  Stitch pattern plate	5.  Stitch pattern plate holder
--	---	--	---	--

Optional accessories

The following are available as optional accessories to be purchased separately.

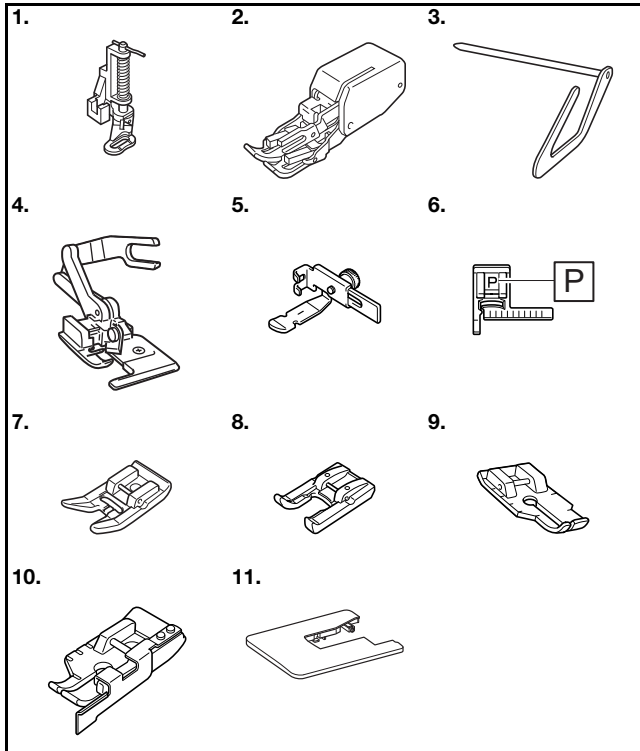

No.	Part Name	Part Code		
		Americas	Europe	Others
1.	Quilting foot	SA129	F005N: XC1948-052	F005N
2.	Walking foot	SA140	F033N: XG6623-001	F033N F033CN
3.	Quilting guide	SA132	F016N: XC2215-052	F016N F016CN
4.	Side cutter "S"	SA177	F054: XC3879-152	F054 F054CN
5.	Adjustable zipper/ piping foot	SA161	F036N: XC1970-052	F036N
6.	Stitch guide foot "P"	SA160	F035N: XG6609-001	F035N
7.	Non stick foot	SA114	F007N: XC1949-052	F007N F007CN
8.	Open toe foot	SA186	F060: XG6687-001	F060
9.	1/4" piecing foot	SA125	F001N: XC1944-052	F001N
10.	1/4" piecing foot with guide	SA185	F057: XC7416-252	F057
11.	Wide table	SAWT5	WT15: XG8750-001	WT15AP WT15CN

Memo

- To obtain optional accessories or parts, contact your authorized Brother dealer or visit our site <http://s.brother/cpjah/>.
- All specifications are correct at the time of printing. Please be aware that some specifications may change without notice.
- A variety of feet are available to enable different types of stitching and finishes. Visit your nearest authorized Brother dealer or our site <http://s.brother/cpjah/> for a complete listing of optional accessories available for your machine.
- Always use accessories recommended for this machine.

Attaching the stitch pattern plate (For models equipped with the stitch pattern plate)

The stitch pattern plate shows the stitches and the stitch numbers. Attach the stitch pattern plate to the stitch pattern plate holder, and then attach the stitch pattern plate holder to the handle of the sewing machine as shown in the illustration below.

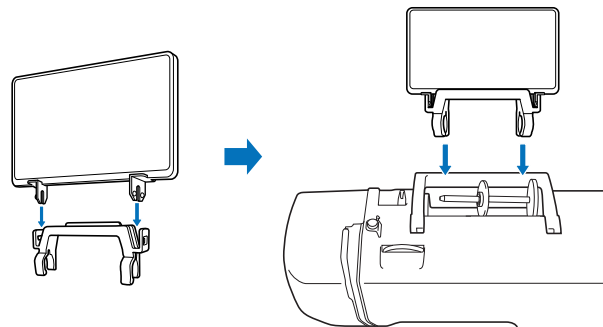

(For models equipped with the hard case)

When storing the machine, the stitch pattern plate can be hung from the hard case.

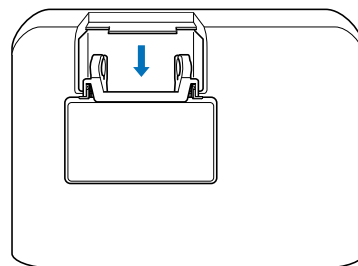

Turning the Machine On/Off

⚠ WARNING

- Use only regular household electricity for the power source. Using other power sources may result in fire, electric shock, or damage to the machine.
- Make sure that the plugs on the power cord are firmly inserted into the electrical outlet and the power cord receptacle on the machine. Otherwise, a fire or electric shock may result.
- Do not insert the plug on the power cord into an electrical outlet that is in poor condition.
- Turn the main power to OFF and remove the plug in the following circumstances:
 - When you are away from the machine
 - After using the machine
 - When the power fails during use
 - When the machine does not operate correctly due to a bad connection or a disconnection
 - During electrical storms

⚠ CAUTION

- Use only the power cord included with this machine.
- Do not use extension cords or multi-plug adapters with any other appliances plugged into them. Fire or electric shock may result.
- Do not touch the plug with wet hands. Electric shock may result.
- When unplugging the machine, always turn the main power to OFF first. Always grasp the plug to remove it from the electrical outlet. Pulling on the cord may damage the cord, or lead to fire or electric shock.
- Do not allow the power cord to be cut, damaged, modified, forcefully bent, pulled, twisted, or bundled. Do not place heavy objects on the cord. Do not subject the cord to heat. These things may damage the cord, or cause fire or electric shock. If the cord or plug is damaged, take the machine to your authorized Brother dealer for repairs before continuing use.
- Unplug the power cord if the machine is not to be used for a long period of time. Otherwise, a fire may result.

- (For U.S.A. only)
This appliance has a polarized plug (one blade wider than the other). To reduce the risk of electrical shock, this plug is intended to fit in a polarized electrical outlet only one way. If the plug does not fit fully in the electrical outlet, reverse the plug. If it still does not fit, contact a qualified electrician to install the proper electrical outlet. Do not modify the plug in any way.

- 1 Make sure that the machine is turned off (the main power switch is set to "O"), and then plug the power cord into the power supply jack on the right side of the machine.
- 2 Insert the plug of the power cord into a household electrical outlet.

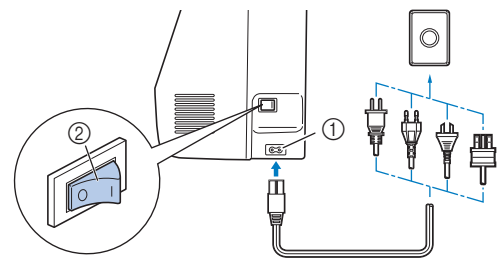

- ① Power supply jack
② Main power switch

- 3 Press the right side of the main power switch on the right side of the machine to turn the machine on (set it to "I").

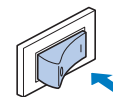

→ The light for working area and LCD will light up when the machine is turned on. The needle and the feed dogs will make a sound when they move; this is not a malfunction.

- 4 To turn off the machine, press the left side of the main power switch (set it to "O").

LCD Operation

When the machine is turned on, the LCD will light up and the following screen is displayed.
 To change the displayed settings, use the operation keys and stitch pattern selection dial.
 The LCD differs depending on the model.

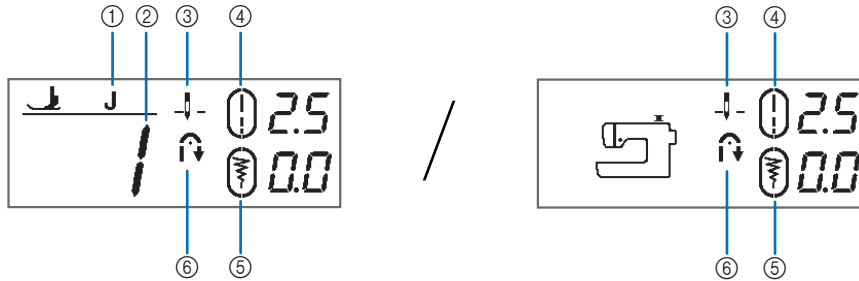

No.	Display	Item Name	Explanation	Page
①	J	Presser foot	Shows the symbol for the presser foot to be used. Before sewing, attach one of the presser feet shown here. J Zigzag foot "J" A Buttonhole foot "A" N Monogramming foot "N" R Blind stitch foot "R" G Overcasting foot "G" * The symbols for certain presser feet, such as zipper foot "I" and the quilting foot, may not appear in the screen.	21
②	-	Stitch number	Shows the number of the currently selected stitch pattern.	33
③	↓	Needle position setting	Shows whether the needle is in the programmed raised or lowered position. In addition, shows whether the single needle mode or twin needle mode is selected. (The twin needle mode indicator appears only on models equipped with the needle mode selection key.) ↓ -: Single needle/down position - -: Twin needle/down position ↓ : Single needle/up position - : Twin needle/up position	11
④	0 2.5	Stitch length	Shows the stitch length of the currently selected stitch pattern.	27
⑤	0 0.0	Stitch width	Shows the stitch width of the currently selected stitch pattern.	27
⑥	↻	Automatic reverse/reinforcement stitching	Shows the automatic reverse/reinforcement stitching is currently turned on.	25

Memo

- On models without the stitch number and the presser foot displayed in the LCD, the stitch number and presser foot are shown in the stitch pattern display window.



Changing the Machine Settings

■ Changing the needle stop position

The needle position when stitching is finished can be changed from the down position to the up position.

- 1 Press the needle position button and hold for approximately 3 seconds.

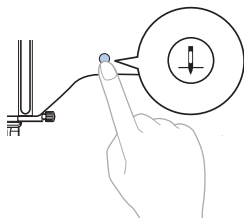

→ The machine beeps twice, and the needle stop position changes to the up position.

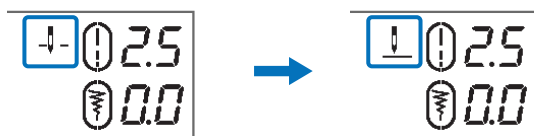

📖 Memo

- When the same operation is performed, the machine beeps once, and the needle stop position changes to the down position.
- When this setting is changed, the machine beeps, even if the buzzer is turned off.

■ Changing the initial needle position (For 80/60/50 stitches models)

The stitch automatically selected when the machine is turned on can be changed from “1 Straight stitch (Left)” to “3 Straight stitch (Middle)”.

- 1 Press and hold the “-” stitch length key while turning on the machine.

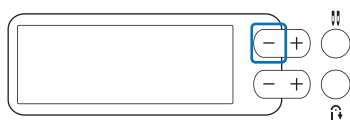

→ The machine beeps once, and the initial needle position changes to “3 Straight stitch (Middle)”.

📖 Memo

- When the same operation is performed, the machine beeps once, and the initial needle position changes to “1 Straight stitch (Left)”.
- When this setting is changed, the machine beeps, even if the buzzer is turned off.

■ Turning on/off the buzzer

The buzzer can be turned off.

- 1 Press and hold “-” stitch width key while turning on the machine.

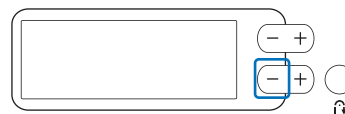

→ The machine starts up with no beep, and the buzzer is turned off.

📖 Memo

- When the same operation is performed, the machine beeps once, and the buzzer is turned on.

⚠ CAUTION

- When the needle stop position or initial needle position is changed, the machine will beep, even if the buzzer has been turned off.

Winding/Installing the Bobbin

⚠ CAUTION

- Only use the plastic bobbin that comes with this machine or bobbins of the same type (SA156/SFB: XA5539-151/SFB). The bobbin's height is 11.5 mm (approx. 7/16 inch). Using other bobbins may cause damage to the machine. SA156 is Class 15 type bobbin.
- Bobbins previously manufactured may not have the "b" mark on the bobbin. However, they can be used with this machine if they are the same type (SA156/SFB: XA5539-151/SFB).

Winding the bobbin

This section describes how to wind thread onto a bobbin.

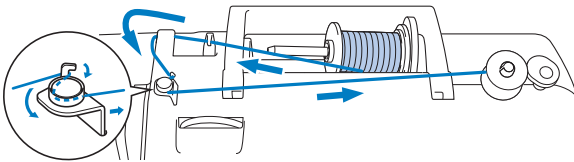

- 1 Place the bobbin on the bobbin winder shaft so that the notch in the bobbin aligns with the spring on the shaft, and then slide the bobbin winder shaft to the right until it snaps into place.

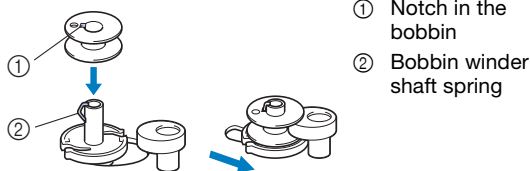

📖 Memo

- Checking the installation orientation of the bobbin will be helpful in later procedures. By placing the bobbin into the bobbin case in the same orientation that it was on the bobbin winder shaft, the bobbin can be installed with the correct winding direction of the bobbin thread.

The "b" mark on one side of the bobbin included with this machine can be used as a reference.

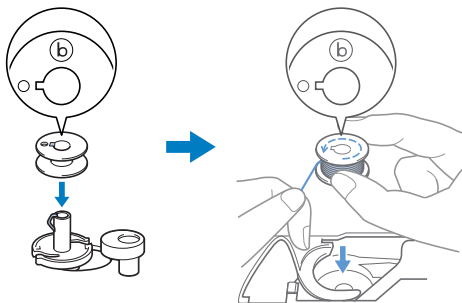

- 2 Remove the spool cap and place the spool of thread for the bobbin onto the spool pin.

Slide the spool onto the spool pin so that the thread unwinds to the front from the bottom. Otherwise the thread may become tangled around the spool pin.

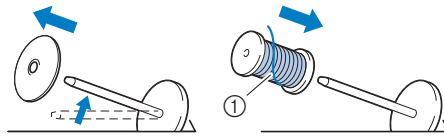

- 1 The thread unwinds to the front from the bottom.

- 3 Slide the spool cap onto the spool pin.

Slide the spool cap as far as possible to the right, as shown, with the rounded side on the left.

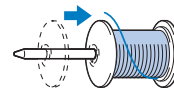

⚠ CAUTION

- If the spool or the spool cap is not installed correctly, the thread may become tangled around the spool pin, causing the needle to break.
- Three spool cap sizes are available, allowing you to choose a spool cap that best fits the size of spool being used. If the spool cap is too small for the spool being used, the thread may catch on the slit in the spool or the machine may be damaged. For more information, refer to "Memo" on page 12.



📖 Memo

- When using the spool as shown below, use the small spool cap, and leave a small space between the cap and the spool.

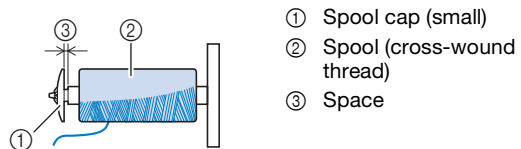

- When using thread that winds off quickly, such as transparent nylon thread or metallic thread, place the spool net over the spool before placing the spool of thread onto the spool pin.

If the spool net is too long, fold it to fit the size of the spool.

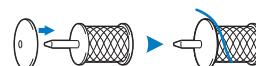

- 4 Pass the thread under the thread guide, then under the thread guide cover and to the front.

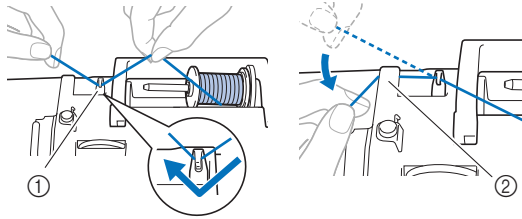

- ① Thread guide
- ② Thread guide cover

- 5 Pass the thread under the hook on the bobbin winding thread guide, and then wind it counterclockwise under the pretension disk.

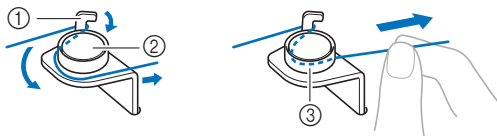

- ① Bobbin winding thread guide
- ② Pretension disk
- ③ Pull it in as far as possible

Note

- Make sure that the thread is passed under the pretension disk.

- 6 Wind the thread clockwise around the bobbin 5 or 6 times, pass the thread through the guide slit in the bobbin winder seat, and then pull the thread to cut it.

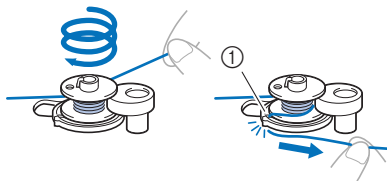

- ① Guide slit in bobbin winder seat (with built-in cutter)

Note

- Be sure to wind the thread clockwise around the bobbin, otherwise the thread will become wrapped around the bobbin winder shaft.

CAUTION

- Be sure to cut the thread as described. If the bobbin is wound without cutting the thread using the cutter built into the guide slit in the bobbin winder seat, the thread may become tangled in the bobbin or the needle may bend or break when the bobbin thread starts to run out.

- 7 Slide the sewing speed controller to adjust the bobbin winding speed. Slide the controller to the right to increase the speed; slide it to the left to reduce the speed.

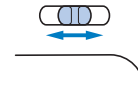

Memo

- We recommend winding stretch thread, such as transparent nylon thread, at a low speed since the thread may stretch.

- 8 Turn on the machine.

- 9 Press the "Start/Stop" button once to start winding the bobbin. When the foot controller is plugged in, press down on the foot controller.



Note

- When winding transparent nylon thread on the bobbin, stop bobbin winding when the bobbin is 1/2 to 2/3 full. If the bobbin was fully wound with transparent nylon thread, it may not be wound neatly, or sewing performance may suffer. In addition, extreme pressure may be applied to the bobbin, it may not be possible to remove the bobbin from the bobbin winder shaft, or the bobbin may break.



- 10 When the bobbin winding becomes slow, press the "Start/Stop" button once to stop the machine. When the foot controller is plugged in, remove your foot from the foot controller.

CAUTION

- When the bobbin winding becomes slow, stop the machine, otherwise the machine may be damaged.

- 11 Cut the thread, slide the bobbin winder shaft to the left until it snaps into place, and then remove the bobbin.

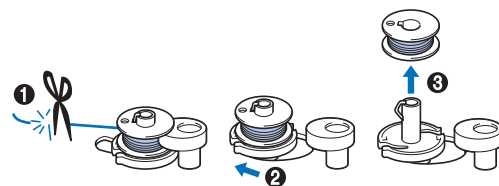

- 12 Slide the sewing speed controller to desired sewing speed position.
- 13 Remove the spool for the bobbin thread from the spool pin.

Installing the bobbin

Install the bobbin wound with thread.
 You can begin sewing immediately without pulling up the bobbin thread by simply inserting the bobbin in the bobbin case and guiding the thread through the slit in the needle plate cover.

Memo

- If the threads will be pulled to create gathers or the thread at the beginning of sewing will be finished, for example, when free motion quilting, first pull up the bobbin thread.
 For details, refer to “Pulling up the bobbin thread” on page 18.

CAUTION

- Use a bobbin that has been correctly wound with thread, otherwise the needle may break or the thread tension will be incorrect.



- Before inserting or changing the bobbin, be sure to turn off the machine, otherwise injuries may occur if the “Start/Stop” button or any other button is pressed and the machine starts operating.

- 1 Turn on the machine.
- 2 Press (Needle position button) once or twice to raise the needle.
- 3 Turn off the machine.
- 4 Raise the presser foot lever.
- 5 Slide the bobbin cover latch to the right and remove the bobbin cover.

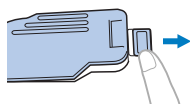

- 6 Place the bobbin in the bobbin case so that the thread unwinds to the left.

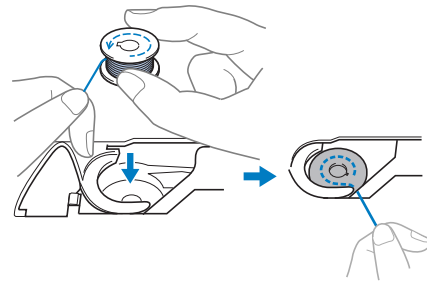

Memo

- For the correct winding direction of the bobbin thread, be sure to place the bobbin into the bobbin case in the same orientation that it was on the bobbin winder shaft.

The “b” mark on one side of the bobbin included with this machine can be used as a reference.

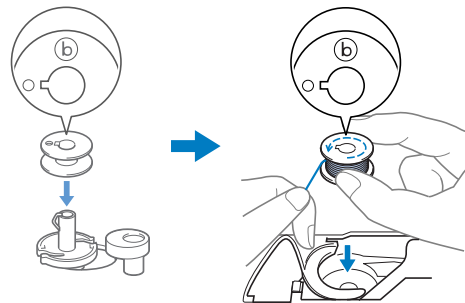

- 7 Lightly hold down the bobbin with your right hand (1), and then guide the end of the thread around the tab of the needle plate cover with your left hand (2).

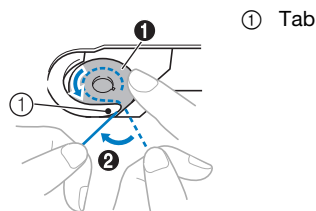

CAUTION

- Be sure to hold down the bobbin with your finger and unwind the bobbin thread correctly, otherwise the thread may break or the thread tension will be incorrect.

- 8** While lightly holding down the bobbin with your right hand (1), guide the thread through the slit in the needle plate cover (2) and lightly pull it with your left hand (3).

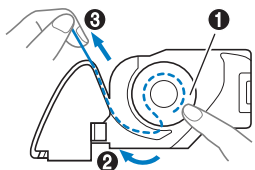

Memo

- By guiding the thread around the tab of the needle plate cover, passing the thread as shown by 2 in this illustration, then lightly pulling the thread at 3, the thread will enter the tension spring of the bobbin case to apply the appropriate tension to the bobbin thread during sewing.

- 9** While lightly holding down the bobbin with your right hand (1), continue guiding the thread through the slit with your left hand (2). Then, cut the thread with the cutter (3).

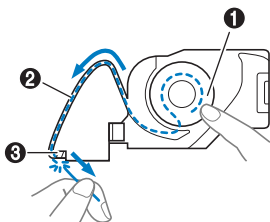

Memo

- Be sure to complete the bobbin threading correctly according to these instructions. If the thread is simply placed in the slit in the needle plate cover, the bobbin thread will not be correctly threaded, resulting in poor sewing performance or incorrect thread tension.

- 10** Reattach the bobbin cover.

Insert the tab of the bobbin cover into the notch of the needle plate cover, and then lightly press down on the right side.

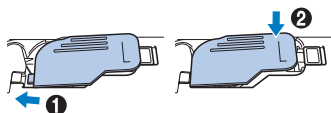

Memo

- You can begin sewing without pulling up the bobbin thread. If you wish to pull up the bobbin thread before starting to sew, pull up the thread according to the procedure in "Pulling up the bobbin thread" on page 18.

Upper Threading

CAUTION

- When threading the upper thread, carefully follow the instructions. If the upper threading is not correct, the thread may become tangled or the needle may bend or break.
- Never use a thread weight of 20 or lower.
- Use the needle and the thread in the correct combination. (page 19)

Threading the upper thread

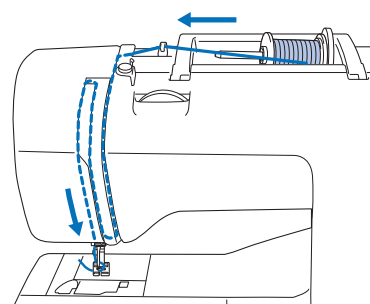

→ When threading the upper thread, carefully follow the instructions.

- Turn on the machine.
- Raise the presser foot lever to raise the presser foot.

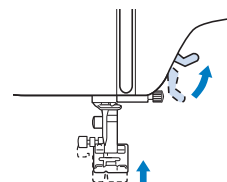

Note

- If the presser foot is not raised, the machine cannot be threaded.

- 3** Press  (Needle position button) once or twice to raise the needle.

→ The needle is correctly raised when the mark on the handwheel is at the top, as shown below. Check the handwheel and, if this mark is not at this position, press  (Needle position button) until it is.

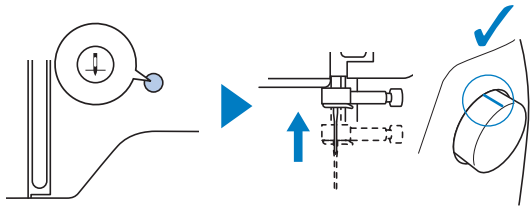

- 4** Turn off the machine.

CAUTION

- Before threading the needle, be sure to turn off the machine, otherwise injuries may occur if the “Start/Stop” button or any other button is pressed, causing the machine to start operating.

- 5** Remove the spool cap and place the spool of thread onto the spool pin.

Slide the spool onto the spool pin so that the thread unwinds to the front from the bottom. Otherwise the thread may become tangled around the spool pin.

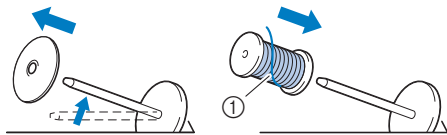

- ① The thread unwinds to the front from the bottom.

- 6** Slide the spool cap onto the spool pin.

Slide the spool cap as far as possible to the right, as shown, with the rounded side on the left.

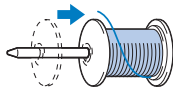

CAUTION

- Choose a spool cap that best fits the size of spool being used. For more information regarding the choice of spool caps for your thread choice, refer to “Memo” on page 12.



- If the spool or the spool cap is not positioned correctly, the thread may become tangled around the spool pin or the needle may break.

- 7** Pass the thread under the thread guide, then under the thread guide cover and to the front.

Hold the thread with your right hand so that there is no slack in the thread that is pulled out, and then pass the thread under the thread guide cover with your left hand.

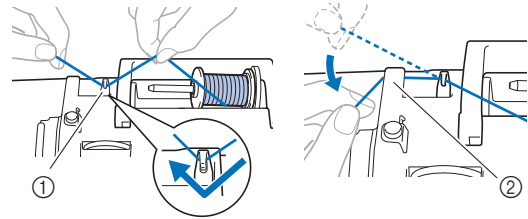

- ① Thread guide
② Thread guide cover

- 8** Pass the thread through the thread channel in the order shown below.

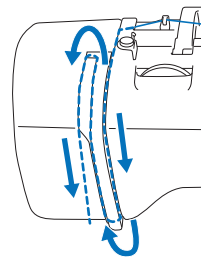

- 9** Make sure that the thread is passed into the thread take-up lever as shown below.

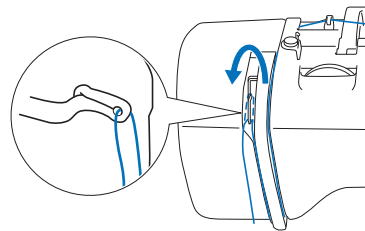

- 10** Slide the thread behind the needle bar thread guide.

The thread can easily be slid behind the needle bar thread guide by holding the thread in your left hand, then feeding the thread with your right hand, as shown. Make sure that the thread is passed through to the left of the tab of the needle bar thread guide.

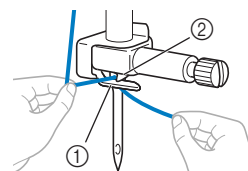

- ① Needle bar thread guide
② Tab

11 Check that the needle and thread are compatible with the needle threader. If they are compatible, continue with the next step.

- The needle threader can be used with machine needles 75/11 through 100/16.
- The needle threader cannot be used with the wing needle or the twin needle.
- When thread such as transparent nylon monofilament or specialty threads are used, it is not recommended to use the needle threader.
- If the needle threader cannot be used, insert the thread through the eye of the needle from front to back by hand. At this time, be sure that the machine has been turned off as described in step 4.

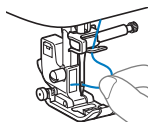

12 Pull the end of the thread, which has been passed through the needle bar thread guide, to the left, pass the thread under the notch, and then firmly pull the thread to fully insert it from front to back into the slit of the thread guide disk (marked "7").

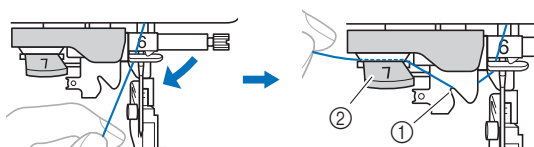

- ① Notch of the threader thread guide
② Threader thread guide disk

13 Cut the thread with the thread cutter on the left side of the machine.

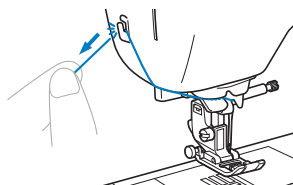

Note

- If the thread is pulled through and cannot be cut correctly, lower the presser foot lever so that the thread is held in place before cutting the thread. If this operation is performed, proceed to step 15.
- When using thread that quickly winds off the spool, such as metallic thread, it may be difficult to thread the needle if the thread is cut. Therefore, instead of using the thread cutter, pull out about 8 cm (approx. 3 inches) of thread after passing it through the threader thread guide disk (marked "7").

14 Lower the presser foot lever to lower the presser foot.

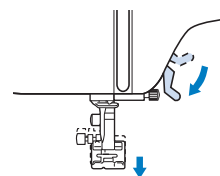

15 Lower the needle threader lever on the left side of the machine as much as possible to make the hook turn.

After the threader thread guide disk is lowered (①), the hook turns (②).

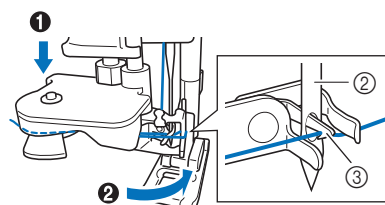
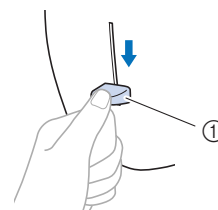

- ① Needle threader lever
② Needle
③ Hook

Note

- If the needle is not raised to its highest position, the needle threader cannot thread the needle. Turn handwheel counterclockwise until the needle is at its highest position. The needle is correctly raised when the mark on the handwheel is at the top, as shown under step 3 on page 15.

16 Raise the needle threader lever slowly.

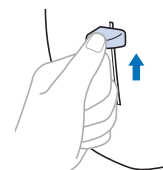

17 Carefully pull the end of thread that was passed through the eye of the needle.

If the needle was not completely threaded, but a loop in the thread was formed in the eye of the needle, carefully pull the loop through the eye of the needle to pull out the end of the thread.

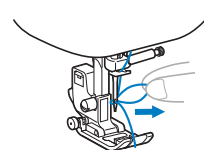

- 18** Raise the presser foot lever, pass the end of the thread through and under the presser foot, and then pull out about 5 cm (approx. 2 inches) of thread toward the rear of the machine.

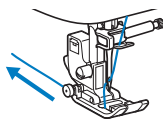

- 19** Turn on the machine.

Pulling up the bobbin thread

If the threads will be pulled to create gathers or the thread at the beginning of sewing will be finished, for example, when free motion quilting, first pull up the bobbin thread.

- 1** Refer to “Threading the upper thread” on page 15 to thread the machine with the upper thread and thread the needle.
- 2** Follow steps **1** to **6** “Installing the bobbin” on page 14 for installing the bobbin and to insert the bobbin into the bobbin case.
- 3** Pass the bobbin thread through the slot.
Do not cut the thread with the cutter, otherwise it will be difficult to pull up the bobbin thread.

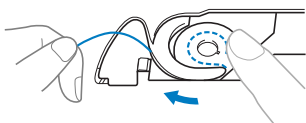

- 4** Turn on the machine.

- 5** While lightly holding the upper thread with your left hand, press \updownarrow (Needle position button) twice to lower and then raise the needle.

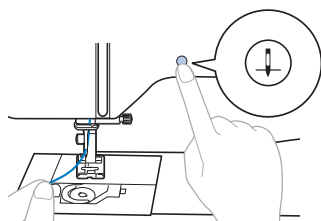

→ The bobbin thread is looped around the upper thread and can be pulled up.

- 6** Carefully pull the upper thread upward to pull out the end of the bobbin thread.

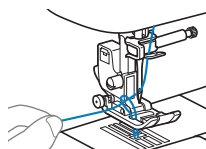

- 7** Pull up the bobbin thread, pass it under the presser foot and pull it about 10 cm (4 inches) toward the back of the machine, making it even with the upper thread.

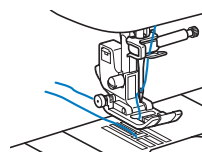

- 8** Reattach the bobbin cover.

Fabric/Thread/Needle Combinations

- **Needles that can be used with this machine: Home sewing machine needles (size 65/9 - 100/16)**
* The larger the number, the larger the needle. As the numbers decrease, the needles get finer.
- **Thread that can be used with this machine: 30 - 90 weight**
* Never use thread of 20 weight or lower. It may cause machine to malfunction.
* The smaller the number, the heavier the thread. As the numbers increase, the thread gets finer.
- **The machine needle and thread that should be used depends on the type and thickness of the fabric. Refer to the following table when choosing the thread and needle appropriate for the fabric that you wish to sew.**
 - The combinations shown in the table provide a general guideline. Be sure to sew trial stitches on the actual number of layers and type of fabric to be used in your project.
 - The machine needles are consumables. For safety and best results, we recommend replacing the needle regularly. For details on when to replace the needle, refer to "Checking the needle" on page 20.
- **In principle, use a fine needle and thread with lightweight fabrics, and a larger needle and heavier thread with heavyweight fabrics.**
- **Select a stitch appropriate for the fabric, and then adjust the stitch length. When sewing lightweight fabrics, make the stitch length finer (shorter). When sewing heavyweight fabrics, make the stitch length coarser (longer). (page 27)**
When sewing stretch fabrics, refer to "Sewing stretch fabrics" on page 31.

Fabric Type/Application		Thread		Size of needle	Stitch length mm (inch)
		Type	Weight		
Lightweight fabrics	Lawn, georgette, challis, organdy, crepe, chiffon, voile, gauze, tulle, lining, etc.	Polyester thread	60 - 90	65/9 - 75/11	Fine stitches 1.8-2.5 (1/16-3/32)
		Cotton thread, Silk thread	50 - 80		
Medium weight fabrics	Broadcloth, taffeta, gabardine, flannel, seersucker, double gauze, linen, terry cloth, waffle weave, sheeting, poplin, cotton twill, satin, quilting cotton, etc.	Polyester thread	60 - 90	75/11 - 90/14	Regular stitches 2.0-3.0 (1/16-1/8)
		Cotton thread, Silk thread	50 - 60		
Heavyweight fabrics	Denim (12 ounces or more), canvas, etc.	Polyester thread, Cotton thread	30	100/16	Coarse stitches 2.5-4.0 (3/32-3/16)
		Polyester thread	60	90/14 - 100/16	
	Cotton thread, Silk thread	30 - 50			
Stretch fabrics (knit fabrics, etc.)	Jersey, tricot, T-shirt fabric, fleece, interlock, etc.	Polyester thread, Cotton thread, Silk thread	50	Ball point needle 75/11 - 90/14	Setting appropriate for the fabric thickness
For top-stitching		Polyester thread, Cotton thread	30	90/14 - 100/16	Setting appropriate for the fabric thickness
			50 - 60	75/11 - 90/14	

■ Transparent nylon thread

Use a home sewing machine topstitching needle, regardless of the fabric or thread.

■ Sewing decorative stitch patterns (needles and threads)

When sewing lightweight, medium weight or stretch fabrics, use a ball point needle (gold colored) 90/14. When sewing heavyweight fabrics, use a home sewing machine needle 90/14.

In addition, #50 to #60 thread should be used.

⚠ CAUTION

- The appropriate fabric, thread and needle combinations are shown in the preceding table. If the combination of the fabric, thread and needle is not correct, particularly when sewing heavy fabrics (such as denim) with thin needles (such as 65/9 to 75/11), the needle may bend or break. In addition, the stitching may be uneven or puckered or there may be skipped stitches.

Replacing the Needle

⚠ CAUTION

- Only use recommended home sewing machine needles. Use of any other needle may bend the needle or damage the machine.
- Never use bent needles. Bent needles can easily break, possibly resulting in injuries.

Checking the needle

Before using the needle, place the flat side of the needle on a flat surface and check that the distance between the needle and the flat surface is even.

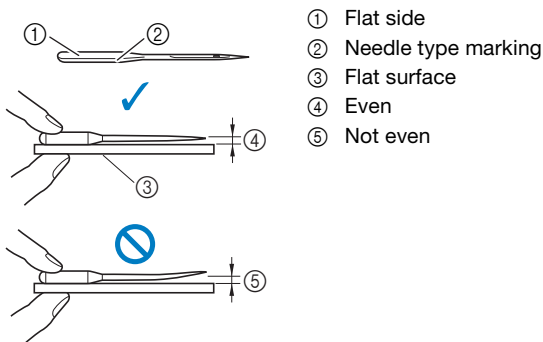

Note

- The machine needles are consumables. Replace the needle in cases such as those described below.
 - If an unusual sound is produced when the needle enters the fabric. (The tip of the needle may be broken or dull.)
 - If stitches are skipped. (The needle may be bent.)
 - Generally, after completing one project, such as a piece of clothing.

Replacing the needle

Use the screwdriver and a new needle that has been determined to be straight according to the instructions in "Checking the needle" on page 20.

- 1 Press  (Needle position button) once or twice to raise the needle.
- 2 Place fabric or paper under the presser foot to cover the hole in the needle plate to prevent the needle from falling into the machine.

- 3 Turn off the machine.

⚠ CAUTION

- Before replacing the needle, be sure to turn off the machine, otherwise injuries may occur if the "Start/Stop" button or any other button is pressed and the machine starts operating.

- 4 Hold the needle with your left hand, and then use a screwdriver to turn the needle clamp screw toward you (counterclockwise) to remove the needle.

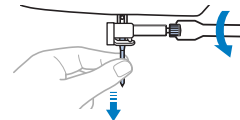

- Do not apply a strong force when loosening or tightening the needle clamp screw, otherwise certain parts of the machine may be damaged.

- 5 With the flat side of the needle toward the rear of the machine, insert the new needle until it touches the needle stopper. Using the screwdriver, tighten the needle clamp screw by turning it clockwise.

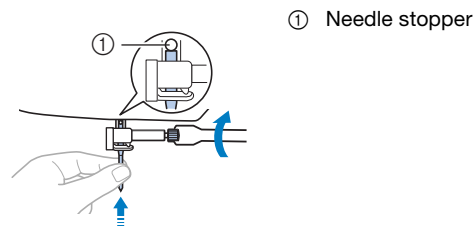

⚠ CAUTION

- Be sure to insert the needle until it touches the needle stopper and securely tighten the needle clamp screw with the screwdriver, otherwise the needle may break or damage may result.

- 6 Turn on the machine.

Replacing the Presser Foot

⚠ CAUTION

- Use the appropriate presser foot for the type of stitch that you wish to sew, otherwise the needle may hit the presser foot, causing the needle to bend or break. For details on the presser foot that should be used with the selected stitch, refer to “Stitch Chart” on page 33.
- Only use presser feet designed specifically for this machine. Use of any other presser foot may result in injuries or damage to the machine.

💡 Note

- When a stitch is selected, the symbol for the presser foot that should be used is shown in the LCD or the stitch pattern display window. Check that the appropriate presser foot is attached before starting to sew. If the wrong presser foot is attached, attach the appropriate presser foot. The position where the symbol for the presser foot is shown differs depending on the model.



* The symbols for certain presser feet, such as zipper foot “I” and the quilting foot, may not appear in the screen.

Replacing the presser foot

- 1 Press \oplus (Needle position button) once or twice to raise the needle.
- 2 Turn off the machine.

⚠ CAUTION

- Before replacing the presser foot, be sure to turn off the machine, otherwise injuries may occur if the “Start/Stop” button or any other button is pressed and the machine starts operating.

- 3 Raise the presser foot lever.
- 4 Press the black button at the back of the presser foot holder in order to remove the presser foot.

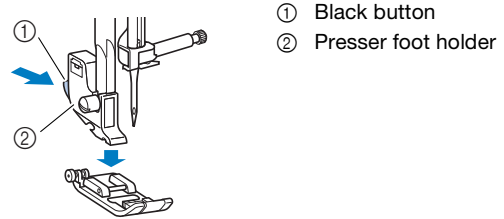

- ① Black button
- ② Presser foot holder

- 5 Place the appropriate presser foot below the presser foot holder so that the presser foot pin is aligned with the notch in the presser foot holder.

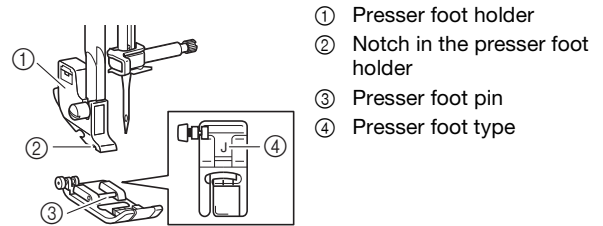

- ① Presser foot holder
- ② Notch in the presser foot holder
- ③ Presser foot pin
- ④ Presser foot type

- 6 Slowly lower the presser foot lever so that the presser foot pin snaps into the notch in the presser foot holder.

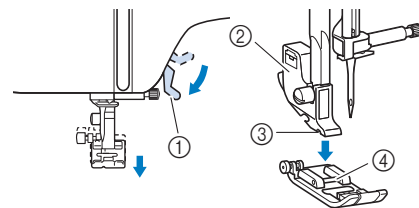

- ① Presser foot lever
- ② Presser foot holder
- ③ Notch in the presser foot holder
- ④ Presser foot pin

→ The presser foot is attached.

- 7 Raise the presser foot lever to check that the presser foot is securely attached.

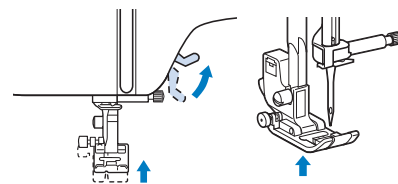

- 8 Turn on the machine.

Removing and attaching the presser foot holder

Remove the presser foot holder when cleaning the machine or when installing a presser foot that does not use the presser foot holder, such as the walking foot and quilting foot.

■ Removing the presser foot holder

- 1 Turn off the machine.
- 2 Remove the presser foot.
 - For details, refer to “Replacing the presser foot” on page 21.
- 3 Use the screwdriver to loosen the presser foot holder screw.

Turn the screw toward the back of the machine (counterclockwise).

 - The presser foot holder screw can also be loosened or tightened with the disc-shaped screwdriver.

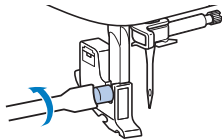

■ Attaching the presser foot holder

- 1 Turn off the machine.
- 2 Raise the presser foot lever.
- 3 Align the notch in the presser foot holder with the screw.

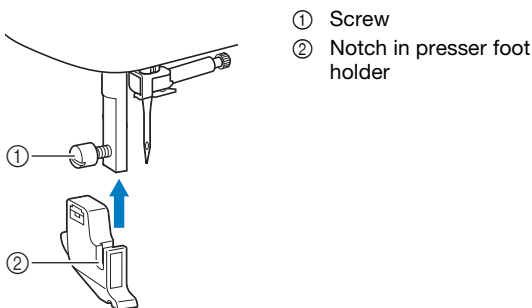

- 4 Hold the presser foot holder in place with your right hand, and then tighten the screw using the screwdriver in your left hand.

Turn the screw toward you (clockwise).

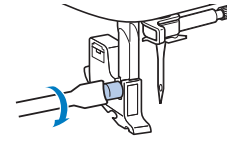

⚠ CAUTION

- Be sure to securely tighten the presser foot holder screw, otherwise the presser foot holder may fall off and the needle may strike it, causing the needle to bend or break.

Chapter 2 SEWING BASICS

Sewing

⚠ CAUTION

- While the machine is in operation, pay special attention to the needle location. In addition, keep your hands away from all moving parts such as the needle and handwheel, otherwise injuries may occur.
- Do not pull or push the fabric too hard while sewing, otherwise injuries may occur or the needle may break.
- Never use bent needles. Bent needles can easily break, possibly resulting in injuries.
- Make sure that the needle does not strike basting pins, otherwise the needle may break or bend.

Basic sewing

💡 Note

- First, perform a trial sewing, using a piece of fabric and thread that are the same as those used for your project.

- 1 Prepare the appropriate needle and thread for the type of fabric. (page 19)
If necessary, replace the needle. (page 20)
- 2 Wind thread onto a bobbin, and then install it into the machine. (page 12)
- 3 Thread the upper thread. (page 15)
- 4 Turn the stitch pattern selection dial to select a stitch.
The position where the stitch number is shown differs depending on the model.

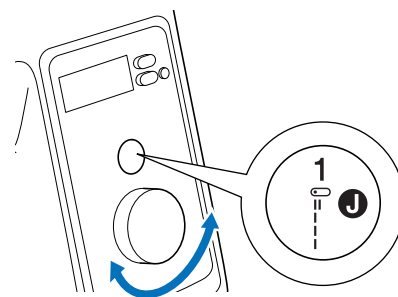
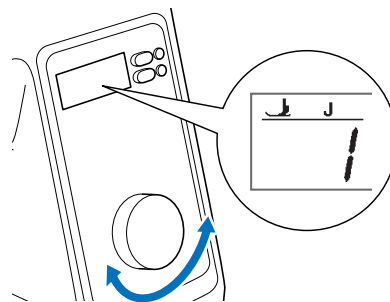

- For details on the built-in stitch patterns, refer to “Stitch Chart” on page 33.
- If necessary, change the stitch width or stitch length. (page 27)
- For details on the LCD viewing, refer to “LCD Operation” on page 10.

- 5 Check the symbol for the presser foot shown in the LCD or stitch pattern display window, and then attach the appropriate presser foot. Attach zigzag foot "J" in this procedure. (It is on the machine when purchased.)

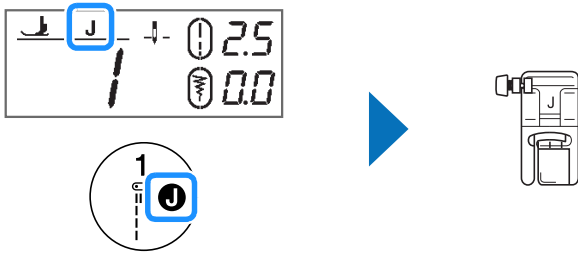

- For details on changing the presser foot, refer to "Replacing the Presser Foot" on page 21.

⚠ CAUTION

- Always use the appropriate presser foot. If the wrong presser foot is used, the needle may strike the presser foot and bend or break, possibly resulting in injury. Refer to "Stitch Chart" on page 33 for presser foot recommendations.

- 6 Set the fabric under the presser foot. Hold the fabric and thread with your left hand, and rotate the handwheel counterclockwise or press \uparrow (Needle position button) to set the needle in the sewing start position.

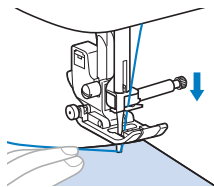

- 7 Lower the presser foot lever.

- 8 Adjust the sewing speed with the sewing speed controller.

You can use this controller to adjust sewing speed during sewing.

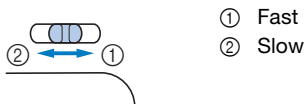

- 9 Press the "Start/Stop" button to start sewing. (When the foot controller is plugged in, slowly press down on the foot controller.)

Guide the fabric lightly by hand.

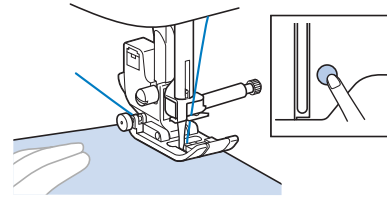

📖 Memo

- When the foot controller is being used, you cannot start sewing by pressing the "Start/Stop" button.

- 10 Press the "Start/Stop" button again to stop sewing. (When the foot controller is plugged in, remove your foot from the foot controller.)

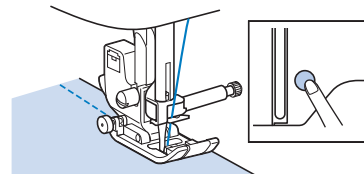

- 11 Press \uparrow (Needle position button) to raise the needle.

- 12 Raise the presser foot lever, and then remove the fabric.

- 13 Pull the fabric to the left side of the machine, and then cut the threads by using the thread cutter.

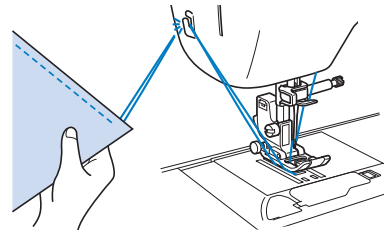

- 14 Check the sewing finish. If necessary, adjust the thread tension. (page 27)

■ Using the foot controller

You can also use the foot controller to start and stop sewing.

📖 Memo

- When the foot controller is connected, you cannot use the "Start/Stop" button.
- Bobbin winding can be started and stopped with the foot controller.

- 1 Turn off the machine.

- 2** Insert the foot controller plug into the foot controller jack on the machine.

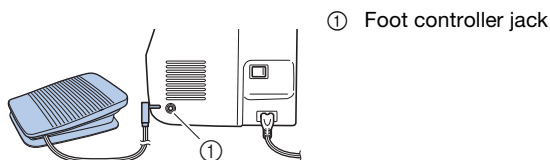

- 3** Turn on the machine.

- 4** Slowly depress the foot controller to start sewing.

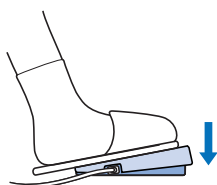

Memo

- The speed that is set using the sewing speed controller will be the foot controller's maximum sewing speed.

- 5** Release the foot controller to stop the machine.

Sewing reverse/reinforcement stitches

Reverse/reinforcement stitches are generally necessary at the beginning and end of sewing. With reinforcement stitches, 3 to 5 stitches are sewn at the same place. With reverse stitches, the stitching is sewn in the opposite direction. Depending on the selected stitch, reverse or reinforcement stitches are sewn while (Reverse stitch button) is pressed continuously.

Memo

- When a reverse stitch pattern or reinforcement stitch pattern is selected, pressing (Reverse stitch button) continuously will sew reverse stitches.
When any other stitch is selected, pressing (Reverse stitch button) continuously will sew reinforcement stitches.
For details, refer to "Stitch Chart" on page 33.
- Pressing (Reinforcement stitch button) continuously sews 3 to 5 stitches at the same place when any stitch pattern is selected.

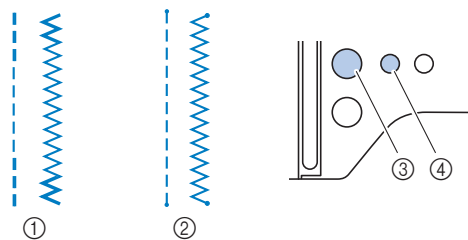

- ① Reverse stitch
② Reinforcement stitch
③ (Reverse stitch button)
④ (Reinforcement stitch button)

Memo

- (For models equipped with an LED beside the reinforcement stitch button)
The green LED beside (Reinforcement stitch button) lights up while a stitch is being sewn. The LED goes off when sewing of the reinforcement stitch is finished.

Automatic reverse/reinforcement stitching

After selecting a stitch pattern, turn on the automatic reverse/reinforcement stitching function before sewing, and the machine will automatically sew reinforcement stitches (or reverse stitches, depending on the stitch pattern) at the beginning and end of sewing.

If the machine is turned off, automatic reverse/reinforcement stitching will be turned off.

- 1** Select a stitch.
- For details on selecting a stitch, refer to "Basic sewing" on page 23.
- 2** Press (Automatic reverse/reinforcement key) to set the automatic reverse/reinforcement stitching function.

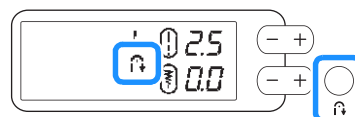

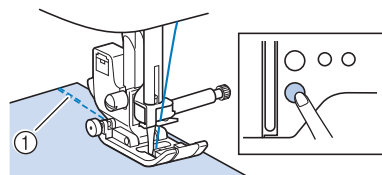

→ appears in the LCD.

- 3** Set the fabric in the start position and press the "Start/Stop" button to begin sewing.





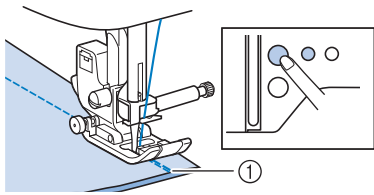

- ① Reverse stitches (or reinforcement stitches)
→ The machine will automatically sew reverse stitches (or reinforcement stitches) and then continue sewing.



4 Once you have reached the end of the stitching, press  (Reverse stitch button) or  (Reinforcement stitch button).

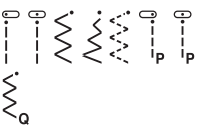

① Reverse stitches (or reinforcement stitches)
 → The machine will sew reverse stitches (or reinforcement stitches) and stop.

The operation performed when either of these buttons is pressed differs depending on the selected stitch pattern. Refer to the following table for details on the operation that is performed when the button is pressed.

	Reverse stitch button 	Reinforcement stitch button 
When the automatic reverse/reinforcement stitching function is not active with a reverse stitch pattern selected: 	Machine sews reverse stitches while holding the button.	Machine sews 3 - 5 reinforcement stitches while holding the button.
When the automatic reverse/reinforcement stitching function is not active with a reinforcement stitch pattern selected: 	Machine sews reverse stitches while holding the button.*	Machine sews 3 - 5 reinforcement stitches while holding the button.
When the automatic reverse/reinforcement stitching function is not active with a stitch other than reverse or reinforcement stitch pattern selected.	Machine sews 3 - 5 reinforcement stitches while holding the button.	Machine sews 3 - 5 reinforcement stitches while holding the button.
When the automatic reverse/reinforcement stitching function is not active with a decorative stitch pattern selected.	Machine sews 3 - 5 reinforcement stitches while holding the button.	Machine sews 3 - 5 reinforcement stitches after completing the pattern, when the button is pressed.
When the automatic reverse/reinforcement stitching function is active with a reverse stitch pattern selected: 	Machine sews reverse stitches and stops sewing when the button is pressed. (At the beginning of sewing, reverse stitches are sewn automatically when "Start/Stop" button is pressed.)	Machine sews reinforcement stitches and stops sewing when the button is pressed. (At the beginning of sewing, reinforcement stitches are sewn automatically when "Start/Stop" button is pressed.)

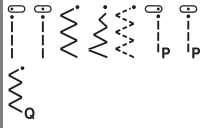
	Reverse stitch button 	Reinforcement stitch button 
When the automatic reverse/reinforcement stitching function is active with a reinforcement stitch pattern selected: 	Machine sews reverse stitches and stops sewing when the button is pressed.* (At the beginning of sewing, reinforcement stitches are sewn automatically when "Start/Stop" button is pressed.)	Machine sews reinforcement stitches and stops sewing when the button is pressed. (At the beginning of sewing, reinforcement stitches are sewn automatically when "Start/Stop" button is pressed.)
When the automatic reverse/reinforcement stitching function is active with a stitch other than reverse or reinforcement stitch pattern selected.	Machine sews reinforcement stitches and stops sewing when the button is pressed. (At the beginning of sewing, reinforcement stitches are sewn automatically when "Start/Stop" button is pressed.)	Machine sews reinforcement stitches and stops sewing when the button is pressed. (At the beginning of sewing, reinforcement stitches are sewn automatically when "Start/Stop" button is pressed.)
When the automatic reverse/reinforcement stitching function is active with a decorative stitch pattern selected.	Machine sews 3 - 5 reinforcement stitches and stops sewing when the button is pressed. (At the beginning of sewing, reinforcement stitches are sewn automatically when "Start/Stop" button is pressed.)	Machine sews 3 - 5 reinforcement stitches and stops sewing after completing the pattern, when the button is pressed. (At the beginning of sewing, reinforcement stitches are sewn automatically when "Start/Stop" button is pressed.)

* When reinforcement priority is turned "ON", reinforcement stitches will be sewn instead of reverse stitches. Refer to "Reinforcement priority" on page 27.

 **Memo**

- Some stitches, such as buttonholes and bar tacks, require reinforcement stitches at the beginning of sewing. If you select one of these stitches, the machine will automatically turn on this function ( appears on the LCD when the stitch is selected).

Reinforcement priority

When reinforcement priority is turned on, reinforcement stitches will be sewn at the beginning and/or end of sewing a reinforcement stitch pattern, even if  (Reverse stitch button) is pressed. For details, refer to "Automatic reverse/reinforcement stitching" on page 25.

- 1 Turn off the machine.
- 2 While pressing  (Reinforcement stitch button), turn on the sewing machine.
- 3 Press the "-" or "+" key.

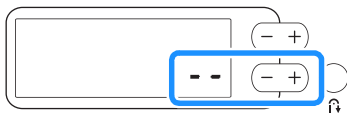

→ The value in the LCD changes from " -- " to "00".

- 4 Turn off the machine, then turn it on again.
→ Reinforcement priority is turned on.

Memo

- When the same operation is performed, the reinforcement priority is turned off.

Setting the stitch width/stitch length

This machine is preset with the default settings for the stitch width and stitch length for each stitch. These settings can be changed as needed.

Memo

- To return the settings to their defaults, turn off the machine, or select a different stitch.
- If a straight stitch or triple stretch stitch is selected, changing the stitch width changes the needle position. Increasing the width moves the needle to the right; reducing the width moves the needle to the left. (page 27)





CAUTION

- After adjusting the stitch width, slowly turn the handwheel toward you (counterclockwise) and check that the needle does not touch the presser foot. If the needle hits the presser foot, the needle may bend or break.
- If the stitches are bunched together, increase the stitch length. Continuing to sew with the stitches bunched together may result in the needle bending or breaking.

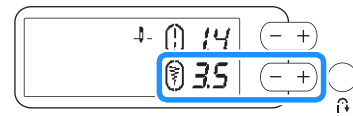
Setting the stitch width

The stitch width (zigzag width) can be adjusted to make the stitch wider or narrower.





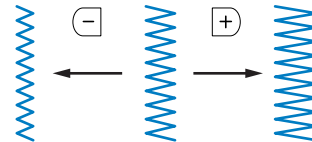

When the stitch width is changed from the default setting,  around  disappears. When the stitch width is reset back to the default setting,  reappears around .

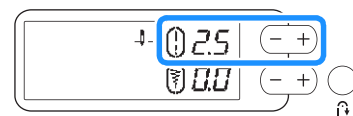

Setting the stitch length

The stitch length can be adjusted to make the stitch coarser (longer) or finer (shorter).



When the stitch length is changed from the default setting,  around  disappears. When the stitch length is reset back to the default setting,  reappears around .

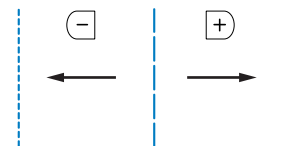

Adjusting the thread tension

You may need to change the thread tension, depending on the fabric and thread being used.

Correct thread tension

The upper thread and the bobbin thread should cross near the center of the fabric. Only the upper thread should be visible from the right side of the fabric, and only the bobbin thread should be visible from the wrong side of the fabric.

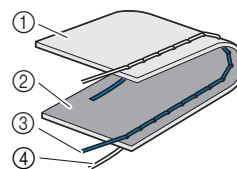

- ① Wrong side of fabric
- ② Right side of fabric
- ③ Upper thread
- ④ Bobbin thread

Upper thread is too tight

If the bobbin thread is visible from the right side of the fabric, the upper thread is too tight. Loosen the thread tension.

Note

- If the bobbin thread was incorrectly threaded, the upper thread may be too tight. In this case, refer to “Installing the bobbin” on page 14 and rethread the bobbin thread.

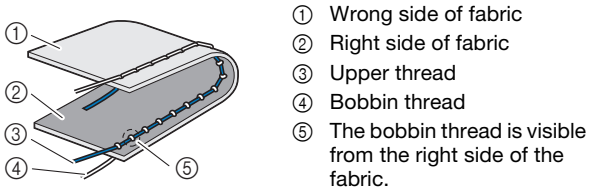

Turn the thread tension dial counterclockwise to loosen the upper thread tension.

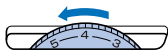

Upper thread is too loose

If the upper thread is visible from the wrong side of the fabric, the upper thread is too loose. Tighten the thread tension.

Note

- If the upper thread was incorrectly threaded, the upper thread may be too loose. In this case, refer to “Upper Threading” on page 15 and rethread the upper thread.

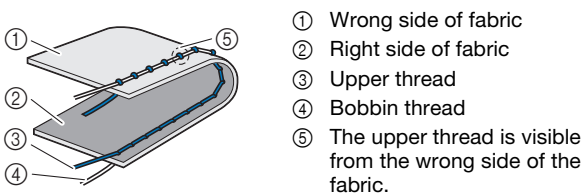

Turn the thread tension dial clockwise to tighten the upper thread tension.



Note

- If the upper thread is not threaded correctly or the bobbin is not installed correctly, it may not be possible to set the correct thread tension. If the correct thread tension cannot be achieved, rethread the upper thread and insert the bobbin correctly.

Useful Sewing Tips

Sewing Tips

Trial sewing

Before starting your sewing project, we recommend sewing trial stitches using thread and scrap fabric that are the same as those used for your project.

While checking the sewing results, adjust the thread tension as well as the stitch length and width according to the number of fabric layers and stitch that is sewn.

Note

- Other factors, such as fabric thickness, stabilizer material, etc., also have an effect on the stitch, so you should always sew a few trial stitches before beginning your project.
- When sewing decorative satin stitch or satin stitch patterns, there may be shrinking or bunching of stitches, so be sure to use a stabilizer material.

Changing the sewing direction

1 When the stitching reaches a corner, stop the machine.

Leave the needle lowered (in the fabric). If the needle remains up when the machine stops sewing, press  (Needle position button) to lower the needle.

2 Raise the presser foot lever, and then turn the fabric.

Turn the fabric using the needle as a pivot.

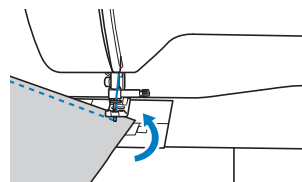

3 Lower the presser foot lever and continue sewing.

Sewing curves

Sew slowly while slightly changing the sewing direction to sew around the curve. For details on sewing with an even seam allowance, refer to “Sewing an even seam allowance” on page 29.

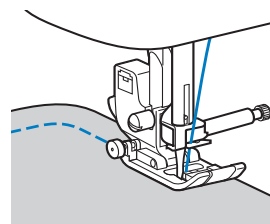

When sewing along a curve while using a zigzag stitch, select a shorter stitch length in order to obtain a finer stitch.

■ Sewing cylindrical pieces

Removing the flat bed attachment allows for free-arm sewing, making it easier to sew cylindrical pieces such as sleeve cuffs and pant legs.

- 1 Pull the flat bed attachment off to the left.

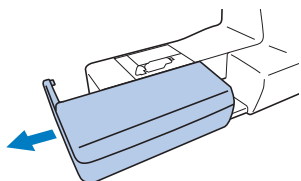

- 2 Slide the part that you wish to sew onto the free arm, and then sew from the top.

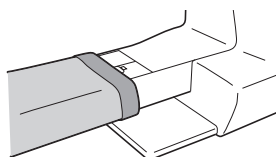

- 3 When you are finished with free arm sewing, install the flat bed attachment back in its original position.

Sewing an even seam allowance

To sew an even seam allowance, start sewing so that the seam allowance is to the right of the presser foot, and the edge of the fabric is aligned with either the right edge of the presser foot or a marking on the needle plate.

■ Changing the needle position

The needle position used as the baseline is different for the straight stitch (left needle position) and the straight stitch (middle (center) needle position).

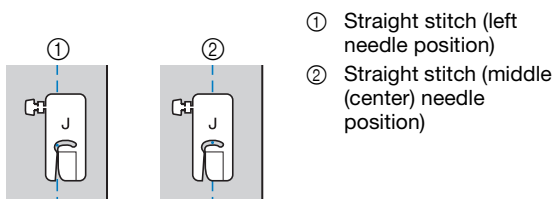

- 1 Straight stitch (left needle position)
- 2 Straight stitch (middle (center) needle position)

When the stitch width of the straight stitch (left needle position) is set to its standard setting (0.0 mm), the distance from the needle position to the right side of the presser foot is 12 mm (1/2 inch). If the stitch width is changed (between 0 and 7.0 mm (1/4 inch)), the needle position will also change. By changing the stitch width and sewing with the right side of the presser foot aligned with the edge of the fabric, a seam allowance can be sewn with a fixed width.

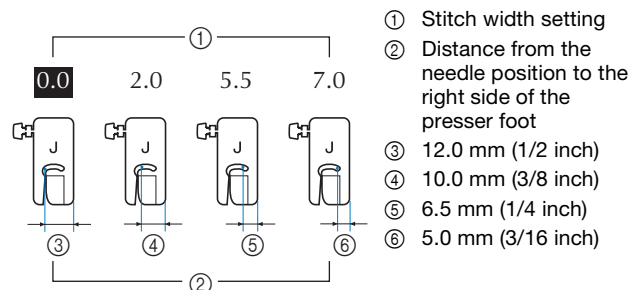

- 1 Stitch width setting
- 2 Distance from the needle position to the right side of the presser foot
- 3 12.0 mm (1/2 inch)
- 4 10.0 mm (3/8 inch)
- 5 6.5 mm (1/4 inch)
- 6 5.0 mm (3/16 inch)

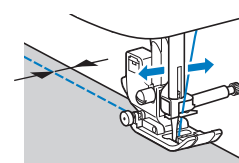

- For details, refer to "Setting the stitch width" on page 27.

■ Aligning the fabric with a needle plate marking

The markings on the needle plate show the distance from the needle position of a seam sewn with the straight stitch (left needle position). Sew while keeping the edge of the fabric aligned with a marking on the needle plate. The distance between the markings in the upper scale is 1/8 inch (3 mm) and the distance between the markings in the grid is 5 mm (3/16 inch).

For stitches with a left needle position (Stitch width: 0.0 mm)

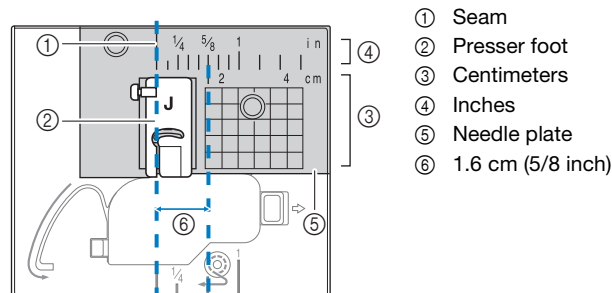

- 1 Seam
- 2 Presser foot
- 3 Centimeters
- 4 Inches
- 5 Needle plate
- 6 1.6 cm (5/8 inch)

■ Aligning the fabric with zigzag foot "J"

The marking on zigzag foot "J" can be used to sew about 5 mm (3/16 inch) from the edge of the fabric. When using this feature, select a straight stitch, and set the stitch width to 2.0 mm.

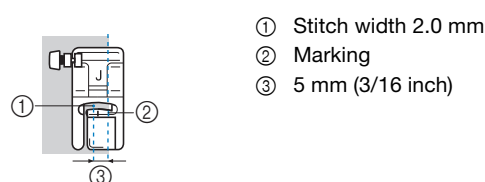

- 1 Stitch width 2.0 mm
- 2 Marking
- 3 5 mm (3/16 inch)

Sewing Various Fabrics

■ Sewing thick fabrics

□ If the fabric does not fit under the presser foot

The presser foot lever can be raised to two different positions. If the fabric does not fit under the presser foot, for example, when sewing together thick fabrics, raise the presser foot lever to its highest position so that the fabric can be placed under the presser foot.

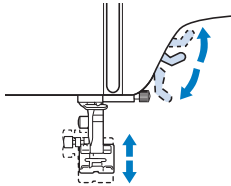

□ If the fabric does not feed

When sewing thick fabric such as denim or quilting, the fabric may not feed at the start of sewing if the presser foot is not level, as shown below. In this case, use the presser foot locking pin (black button) of zigzag foot "J" so that the presser foot remains level while sewing, allowing the fabric to be fed smoothly.

If the presser foot misalignment is too large, place thick paper or fabric (with the same thickness as the fabric being sewn) under the heel of the presser foot to be able to start sewing smoothly.

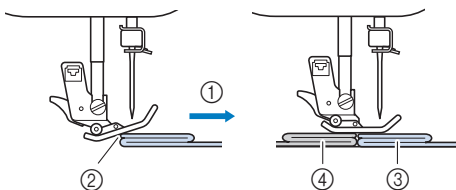

- ① Sewing direction
- ② Misalignment
- ③ Fabric being sewn
- ④ Fabric or thick paper

1 Raise the presser foot lever.

2 Align the beginning of stitching, and then position the fabric.

3 While holding zigzag foot "J" level, push in and hold the presser foot locking pin (black button on the left side), and lower the presser foot lever.

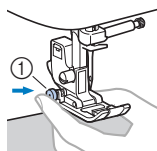

- ① Presser foot locking pin (black button)

4 Release the presser foot locking pin (black button).

→ The presser foot remains level, allowing the fabric to be fed.

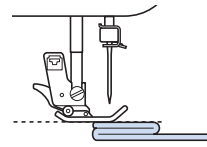

→ After the seam is sewn, the presser foot will return to its original angle.

⚠ CAUTION

- If fabric more than 6 mm (15/64 inch) thick is sewn or if the fabric is pushed with too much force, the needle may bend or break.

■ Sewing thin fabrics

When sewing thin fabrics such as chiffon, the stitching may become misaligned or the fabric may not feed correctly. Move the needle (be sure to use a fine needle) to the furthest left or right hand position so that the fabric does not get pulled down into the feed dog area. If this occurs or there is shrinkage of the stitching, place non-woven water soluble stabilizer under the fabric and sew them together.

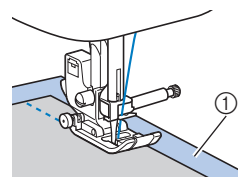

- ① water soluble stabilizer (non-woven)

■ Sewing stretch fabrics

First, baste the pieces of fabric together, and then sew without stretching the fabric. If the stitching is misaligned, place non-woven water soluble stabilizer under the fabric and sew them together.

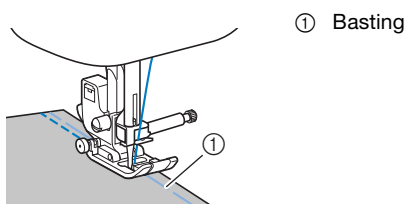

① Basting

For best results when sewing on knit fabrics use the stretch stitches. Also be sure to use a needle for knits (Ball Point needle (gold colored)). The recommended stitches and their stitch numbers are shown below.

Stitch	No.			
	80 stitches	60 stitches	50 stitches	16 stitches
	05	05	05	10
	06	06	06	03
	10	09	09	09

Note

- Be sure to follow manufacturer's instructions when using water soluble stabilizer. It may not be compatible with some fabrics.

■ Sewing leathers or vinyl fabrics

When sewing fabrics that may stick to the presser foot, such as leather or vinyl fabrics, replace the presser foot with the walking foot* or non stick foot* .

* Items sold separately, please contact your authorized Brother dealer.

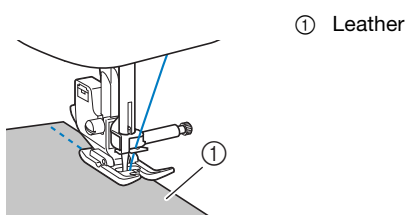

① Leather

If the leather or vinyl fabric sticks to the flat bed attachment, sew with copy paper or tracing paper placed on top of the flat bed attachment so the fabric moves smoothly.

If the paper is positioned so that it does not cover the needle plate, the paper will not be sewn together with the fabric.

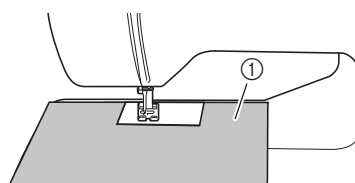

① Copy paper or tracing paper

Note

- The walking foot can only be used with straight or zigzag stitch patterns. Do not sew reverse stitches with the walking foot.
- When sewing with the walking foot, sew at a speed between slow and medium.
- When using the walking foot, test sew on a scrap piece of leather or vinyl that is to be used in project to make sure foot does not leave any marks.

■ Sewing hook-and-loop fastener tape

CAUTION

- Use only the adhesive-free hook-and-loop fastener tape which is designed for sewing. When the glue adheres to the needle or the bobbin case, it may cause malfunction.
- If the hook-and-loop fastener tape is sewn with the thin needle (65/9-75/11), the needle may bend or break.

Note

- Before sewing, baste together the fabric and the hook-and-loop fastener tape.

Make sure that the needle passes through the hook-and-loop fastener tape by turning the handwheel and lower the needle into the hook-and-loop fastener tape before sewing. And then, sew the edge of the hook-and-loop fastener tape at a slow speed.

If the needle does not pass through the hook-and-loop fastener tape, replace the needle with the needle size for thicker fabrics. For details, refer to "Fabric/Thread/Needle Combinations" on page 19.

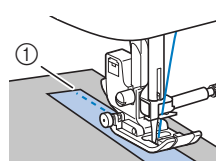

① Edge of the hook-and-loop fastener tape

Sewing decorative stitch patterns

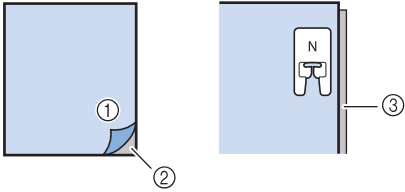
Fabric	<p>When sewing on stretch fabrics, lightweight fabrics, or fabrics with coarse weaves, attach stabilizer on the wrong side of the fabric. An alternative would be to place the fabric on thin paper such as tracing paper.</p>  <p>① Fabric ② Stabilizer ③ Thin paper</p>
Thread	#50 - #60
Needle	<p>With lightweight, regular, or stretch fabrics: the Ball point needle (gold colored) 90/14 With heavyweight fabrics: home machine needle 90/14</p>

Chapter 3 VARIOUS STITCHES

3











VARIOUS STITCHES

Stitch Chart

Utility stitches

Memo

- When any of the following stitches (reverse stitch patterns and reinforcement stitch patterns) are selected, pressing  (Reverse stitch button) will sew reverse stitches.

No.	Stitch											
		80 stitches	01	02	03	04	07	08	09	10	15	16
	60 stitches	01	02	03	04	07	08	-	09	14	-	16
	50 stitches	01	02	03	04	07	08	-	09	14	-	16
	16 stitches	01	-	02	-	04	-	-	09	-	-	-

When any other stitch is selected, pressing  (Reverse stitch button) will sew reinforcement stitches.

- The stitch pattern symbols indicate the following.

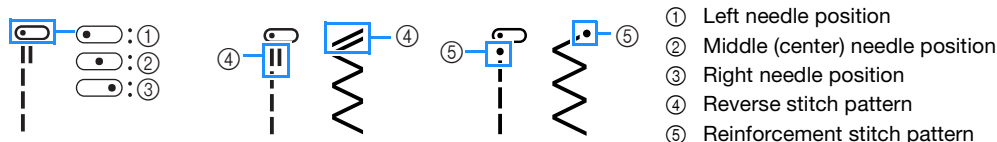





Note

- The walking foot can only be used with straight or zigzag stitch patterns. Do not sew reverse stitches with the walking foot.

*1 Twin needle can be used by attaching zigzag foot "J". (page 33 to 36)





*2 When using the twin needle, set the stitch width between 1.0 mm (1/16 inch) and 6.0 mm (15/64 inch).

*3 When using the twin needle, set the stitch width of 5.0 mm (3/16 inch) or less.

Stitch	No.				Presser foot	Stitch name/Applications	Stitch width (mm (inch)) Auto. Manual	Stitch length (mm (inch)) Auto. Manual
	80 stitches model	60 stitches model	50 stitches model	16 stitches model				
	01 ^{*1}	01 ^{*1}	01 ^{*1}	01	J	Straight stitch (Left) General sewing, gather, pintuck, etc.	0.0 (0) 0.0 - 7.0 (0 - 1/4)	2.5 (3/32) 0.2 - 5.0 (1/64 - 3/16)
	02 ^{*1}	02 ^{*1}	02 ^{*1}	-	J	Straight stitch (Left) General sewing, gather, pintuck, etc.	0.0 (0) 0.0 - 7.0 (0 - 1/4)	2.5 (3/32) 0.2 - 5.0 (1/64 - 3/16)
	03 ^{*1}	03 ^{*1}	03 ^{*1}	02 ^{*1,2}	J	Straight stitch (Middle) General sewing, gather, pintuck, etc.	3.5 (1/8) 0.0 - 7.0 (0 - 1/4)	2.5 (3/32) 0.2 - 5.0 (1/64 - 3/16)
	04 ^{*1}	04 ^{*1}	04 ^{*1}	-	J	Straight stitch (Middle) General sewing, gather, pintuck, etc.	3.5 (1/8) 0.0 - 7.0 (0 - 1/4)	2.5 (3/32) 0.2 - 5.0 (1/64 - 3/16)
	05 ^{*1}	05 ^{*1}	05 ^{*1}	10	J	Triple stretch stitch General sewing for reinforcement and decorative topstitching	0.0 (0) 0.0 - 7.0 (0 - 1/4)	2.5 (3/32) 0.4 - 4.0 (1/64 - 3/16)

Stitch	No.				Presser foot	Stitch name/Applications	Stitch width (mm (inch)) Auto. Manual	Stitch length (mm (inch)) Auto. Manual
	80 stitches model	60 stitches model	50 stitches model	16 stitches model				
	06*1	06*1	06*1	03*1*3	J	Stem stitch Reinforced stitching, sewing and decorative applications	1.0 (1/16) 0.0 - 7.0 (0 - 1/4)	2.5 (3/32) 0.4 - 4.0 (1/64 - 3/16)
	07*1	07*1	07*1	04*1*3	J	Zigzag stitch For overcasting, mending.	3.5 (1/8) 0.0 - 7.0 (0 - 1/4)	1.4 (1/16) 0.0 - 4.0 (0 - 3/16)
	08*1	08*1	08*1	-	J	Zigzag stitch For overcasting, mending.	3.5 (1/8) 0.0 - 7.0 (0 - 1/4)	1.4 (1/16) 0.0 - 4.0 (0 - 3/16)
	09*1	-	-	-	J	Zigzag stitch (Right) Start from right needle position, zigzag sews to left.	3.5 (1/8) 2.5 - 5.0 (3/32 - 3/16)	1.4 (1/16) 0.3 - 4.0 (1/64 - 3/16)
	10*1	09*1	09*1	09*1*3	J	3 steps elastic zigzag stitch Overcasting (medium, heavyweight and stretch fabrics), tape and elastic	5.0 (3/16) 0.0 - 7.0 (0 - 1/4)	1.0 (1/16) 0.2 - 4.0 (1/64 - 3/16)
	11	10	10	05	G	Overcasting stitch Reinforcing of light and medium weight fabrics	3.5 (1/8) 2.5 - 5.0 (3/32 - 3/16)	2.0 (1/16) 0.4 - 4.0 (1/64 - 3/16)
	12	11	11	06	G	Overcasting stitch Reinforcing of heavyweight fabric	5.0 (3/16) 2.5 - 5.0 (3/32 - 3/16)	2.5 (3/32) 0.4 - 4.0 (1/64 - 3/16)
	13	12	12	-	G	Overcasting stitch Reinforcing of medium, heavyweight and easily friable fabrics or decorative stitching.	5.0 (3/16) 3.5 - 5.0 (1/8 - 3/16)	2.5 (3/32) 0.4 - 4.0 (1/64 - 3/16)
	14*1	13*1	13*1	-	J	Overcasting stitch Reinforced seaming of stretch fabric	5.0 (3/16) 0.0 - 7.0 (0 - 1/4)	2.5 (3/32) 0.4 - 4.0 (1/64 - 3/16)
	15	14	14	-	J	Piecing stitch (Right) Piecework/patchwork 6.5 mm (approx. 1/4 inch) right seam allowance	5.5 (7/32) 0.0 - 7.0 (0 - 1/4)	2.0 (1/16) 0.2 - 5.0 (1/64 - 3/16)
	16	-	-	-	J	Piecing stitch (Middle) Piecework/patchwork	-.-	2.0 (1/16) 0.2 - 5.0 (1/64 - 3/16)
	17	15	15	-	J	Hand-look quilting stitch Quilting stitch made to look like hand quilting when using transparent nylon thread for the upper thread and a thread color matching the quilt for the bobbin thread. Sew with a tight thread tension so that the bobbin thread is visible from the right side of the fabric. Use a needle between 90/14 and 100/16.	0.0 (0) 0.0 - 7.0 (0 - 1/4)	2.5 (3/32) 0.4 - 4.0 (1/64 - 3/16)
	18	16	16	-	J	Quilting appliqué zigzag stitch Zigzag stitch for quilting and sewing on appliqué quilt pieces	3.5 (1/8) 0.0 - 7.0 (0 - 1/4)	1.4 (1/16) 0.0 - 4.0 (0 - 3/16)
	19	17	-	-	J	Quilting appliqué stitch Quilting stitch for invisible appliqué or attaching binding	1.5 (1/16) 0.0 - 3.5 (0 - 1/8)	1.8 (1/16) 0.4 - 4.0 (1/64 - 3/16)
	20	18	17	-	J	Quilting stippling stitch Background quilting	7.0 (1/4) 0.0 - 7.0 (0 - 1/4)	1.6 (1/16) 0.4 - 4.0 (1/64 - 3/16)
	21	19	18	07	R	Blind hem stitch Hemming woven fabrics * The stitch width setting is in neither millimeters nor inches.	00 -3← - →3	2.0 (1/16) 0.4 - 4.0 (1/64 - 3/16)
	22	20	19	08	R	Blind hem stretch stitch Hemming stretch fabric * The stitch width setting is in neither millimeters nor inches.	00 -3← - →3	2.0 (1/16) 0.4 - 4.0 (1/64 - 3/16)
	23*1	21*1	20*1	11*1*3	J	Blanket stitch Appliqués, decorative blanket stitch	3.5 (1/8) 0.0 - 7.0 (0 - 1/4)	2.5 (3/32) 0.4 - 4.0 (1/64 - 3/16)
	24*1	22*1	21*1	-	J	Blanket stitch Appliqués, decorative blanket stitch	2.5 (3/32) 0.0 - 7.0 (0 - 1/4)	2.5 (3/32) 0.4 - 4.0 (1/64 - 3/16)

Stitch	No.				Presser foot	Stitch name/Applications	Stitch width (mm (inch)) Auto. Manual	Stitch length (mm (inch)) Auto. Manual
	80 stitches model	60 stitches model	50 stitches model	16 stitches model				
	25 ^{*1}	23 ^{*1}	22 ^{*1}	-	J	Shell tuck edge stitch Shell tuck edge finish on fabrics	4.0 (3/16) 0.0 - 7.0 (0 - 1/4)	2.5 (3/32) 0.2 - 4.0 (1/64 - 3/16)
	26 ^{*1}	24 ^{*1}	23 ^{*1}	-	N	Satin scallop stitch Decorating collar of blouse, edge of handkerchief	5.0 (3/16) 0.0 - 7.0 (0 - 1/4)	0.5 (1/32) 0.1 - 4.0 (1/64 - 3/16)
	27 ^{*1}	25 ^{*1}	24 ^{*1}	-	J	Patchwork join stitch Patchwork stitches, decorative stitching	4.0 (3/16) 0.0 - 7.0 (0 - 1/4)	1.2 (1/16) 0.2 - 4.0 (1/64 - 3/16)
	28 ^{*1}	26 ^{*1}	25 ^{*1}	-	J	Patchwork double overlock stitch Patchwork stitches, decorative stitching	5.0 (3/16) 0.0 - 7.0 (0 - 1/4)	2.5 (3/32) 0.4 - 4.0 (1/64 - 3/16)
	29 ^{*1}	27 ^{*1}	26 ^{*1}	-	J	Couching stitch Decorative stitching, attaching cord and couching	5.0 (3/16) 0.0 - 7.0 (0 - 1/4)	1.2 (1/16) 0.2 - 4.0 (1/64 - 3/16)
	30 ^{*1}	28 ^{*1}	27 ^{*1}	-	J	Smocking stitch Smocking, decorative stitching	5.0 (3/16) 0.0 - 7.0 (0 - 1/4)	1.6 (1/16) 0.4 - 4.0 (1/64 - 3/16)
	31 ^{*1}	29 ^{*1}	28 ^{*1}	12 ^{*13}	J	Feather stitch Fagoting, decorative stitching	5.0 (3/16) 0.0 - 7.0 (0 - 1/4)	2.5 (3/32) 0.4 - 4.0 (1/64 - 3/16)
	32 ^{*1}	30 ^{*1}	29 ^{*1}	-	J	Fagoting cross stitch Fagoting, bridging and decorative stitching	5.0 (3/16) 0.0 - 7.0 (0 - 1/4)	2.5 (3/32) 0.4 - 4.0 (1/64 - 3/16)
	33	31	30	-	N	Ladder stitch Decorative stitching	4.0 (3/16) 0.0 - 7.0 (0 - 1/4)	3.0 (1/8) 0.4 - 4.0 (1/64 - 3/16)
	34 ^{*1}	32 ^{*1}	31 ^{*1}	-	J	Rick-rack stitch Decorative top stitching	4.0 (3/16) 0.0 - 7.0 (0 - 1/4)	2.5 (3/32) 0.4 - 4.0 (1/64 - 3/16)
	35 ^{*1}	33 ^{*1}	32 ^{*1}	-	J	Decorative stitch Decorative stitching	5.5 (7/32) 0.0 - 7.0 (0 - 1/4)	1.6 (1/16) 0.4 - 4.0 (1/64 - 3/16)
	36 ^{*1}	34 ^{*1}	33 ^{*1}	-	N	Serpentine stitch Decorative stitching and attaching elastic	5.0 (3/16) 0.0 - 7.0 (0 - 1/4)	1.0 (1/16) 0.2 - 4.0 (1/64 - 3/16)
	37	35	34	-	N	Hemstitching Decorative hems, lace attaching pin stitch	3.5 (1/8) 0.0 - 7.0 (0 - 1/4)	2.5 (3/32) 0.4 - 4.0 (1/64 - 3/16)
	38	36	35	-	N	Hemstitching Decorative hems, daisy stitch	6.0 (15/64) 0.0 - 7.0 (0 - 1/4)	3.0 (1/8) 0.4 - 4.0 (1/64 - 3/16)
	39	-	-	-	N	Hemstitching Heirloom, decorative hems	5.0 (3/16) 0.0 - 7.0 (0 - 1/4)	3.5 (1/8) 0.4 - 4.0 (1/64 - 3/16)
	40 ^{*1}	37 ^{*1}	36 ^{*1}	-	N	Hemstitching Heirloom, decorative hems	5.0 (3/16) 0.0 - 7.0 (0 - 1/4)	4.0 (3/16) 0.4 - 4.0 (1/64 - 3/16)
	41 ^{*1}	38 ^{*1}	-	-	N	Hemstitching Heirloom, decorative hems	5.0 (3/16) 0.0 - 7.0 (0 - 1/4)	2.0 (1/16) 0.4 - 4.0 (1/64 - 3/16)
	42	39	37	15	A	Narrow rounded buttonhole stitch Buttonhole on light to medium weight fabrics	5.0 (3/16) 3.0 - 6.0 (1/8 - 15/64)	0.4 (1/64) 0.2 - 1.0 (1/64 - 1/16)
	43	-	-	-	A	Tapered round ended buttonhole stitch Reinforced waist tapered buttonholes	5.0 (3/16) 3.0 - 6.0 (1/8 - 15/64)	0.4 (1/64) 0.2 - 1.0 (1/64 - 1/16)
	44	40	38	14	A	Narrow squared buttonhole stitch Buttonholes for light to medium weight fabrics	5.0 (3/16) 3.0 - 6.0 (1/8 - 15/64)	0.4 (1/64) 0.2 - 1.0 (1/64 - 1/16)
	45	41	39	-	A	Stretch buttonhole stitch Buttonholes for stretch or woven fabrics	6.0 (15/64) 3.0 - 6.0 (1/8 - 15/64)	1.0 (1/16) 0.5 - 2.0 (1/32 - 1/16)

Stitch	No.				Presser foot	Stitch name/Applications	Stitch width (mm (inch)) Auto. Manual	Stitch length (mm (inch)) Auto. Manual
	80 stitches model	60 stitches model	50 stitches model	16 stitches model				
	46	42	40	-	A	Heirloom buttonhole stitch Buttonholes for heirloom and stretch fabrics	6.0 (15/64) 3.0 - 6.0 (1/8 - 15/64)	1.5 (1/16) 1.0 - 3.0 (1/16 - 1/8)
	47	43	41	16	A	Keyhole buttonhole stitch Buttonholes in heavyweight or thick fabrics for larger flat buttons	7.0 (1/4) 3.0 - 7.0 (1/8 - 1/4)	0.5 (1/32) 0.3 - 1.0 (1/64 - 1/16)
	48	44	-	-	A	Tapered keyhole buttonhole stitch Buttonholes in medium to heavy weight fabrics for larger flat buttons	7.0 (1/4) 3.0 - 7.0 (1/8 - 1/4)	0.5 (1/32) 0.3 - 1.0 (1/64 - 1/16)
	49	-	-	-	A	Keyhole buttonhole stitch Buttonholes with vertical bar tack for reinforcement in heavyweight or thick fabrics	7.0 (1/4) 3.0 - 7.0 (1/8 - 1/4)	0.5 (1/32) 0.3 - 1.0 (1/64 - 1/16)
	50	45	42	13	A	Bar tack stitch Reinforcement at opening of pocket, etc.	2.0 (1/16) 1.0 - 3.0 (1/16 - 1/8)	0.4 (1/64) 0.3 - 1.0 (1/64 - 1/16)

Decorative stitches

Use monogramming foot "N".

The twin needle can only be used with satin stitch. In addition, be sure to attach zigzag foot "J" when using the twin needle.

Stitch	No.			
	80 stitches	60 stitches	50 stitches	16 stitches
	51	46	-	-
	52	-	-	-
	53	-	-	-
	54	47	-	-
	55	48	43	-
	56	-	-	-
	57	49	-	-
	58	50	-	-
	59	-	-	-
	60	51	44	-
	61	-	-	-
	62	-	-	-
	63	-	-	-
	64	-	-	-
	65	-	-	-
	--	--	--	-
	67	-	-	-

Stitch	No.				
	80 stitches	60 stitches	50 stitches	16 stitches	
Satin stitches		68	52	45	-
		69	-	-	-
		70	53	46	-
		71	54	47	-
		72	55	-	-
		73	56	-	-
		74	57	48	-
		75	-	-	-
Cross stitch stitches		76	58	-	-
		77	59	49	-
		78	60	50	-
		79	-	-	-
		80	-	-	-

* Pattern for making adjustments. (page 54)

Utility stitches

⚠ CAUTION

- Before replacing the presser foot, be sure to turn off the machine, otherwise injuries may occur if the “Start/Stop” button or any other button is pressed and the machine starts operating. For details on changing the presser foot, refer to “Replacing the Presser Foot” on page 21.

Overcasting Stitches

Sew overcasting stitches along the edges of cut fabric to prevent them from fraying.

■ Using overcasting foot “G”

- 1 Attach overcasting foot “G”.



- 2 Select a stitch.

Stitch	No.			
	80 stitches	60 stitches	50 stitches	16 stitches
	11	10	10	05
	12	11	11	06
	13	12	12	-

- For details, refer to “Stitch Chart” on page 33.

⚠ CAUTION

- When using overcasting foot “G”, be sure to select a stitch that can be used with overcasting foot “G”. If you sew with the incorrect stitch, the needle may hit the presser foot, bending the needle or damaging the presser foot.

- 3 Position the fabric with the edge of the fabric against the presser foot guide, and then lower the presser foot lever.

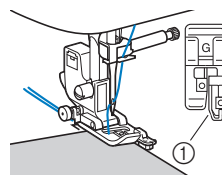

① Presser foot guide

- 4 Rotate the handwheel toward you (counterclockwise). Check that the needle does not touch the presser foot.

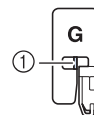

① The needle should not touch the presser foot center bar

- 5 Sew with the edge of the fabric against the presser foot guide.

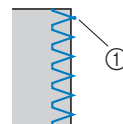

① Needle drop point

⚠ CAUTION

- Be sure to pull the fabric backward after finished sewing. If you pull the fabric toward side or forward, the presser foot pin may be damaged.
- If thread is tangled on the presser foot, remove the entangled thread, and then raise the presser foot lever to remove the presser foot. If the presser foot is raised while entangled with thread, the presser foot may be damaged.

- 6 Press the “Start/Stop” button to stop sewing when you are finished, and raise the presser foot and needle to pull the fabric under the presser foot towards the back of the machine.

■ Using zigzag foot "J"

1 Attach zigzag foot "J".

2 Select a stitch.

Stitch	No.			
	80 stitches	60 stitches	50 stitches	16 stitches
	07	07	07	04
	09	-	-	-
	10	09	09	09
	14	13	13	-

• For details, refer to "Stitch Chart" on page 33.

3 Sew along the edge of the fabric with the needle dropping off the edge at the right.

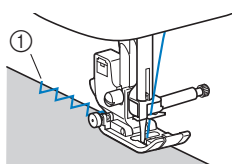

① Needle drop point

Blind Hem Stitching

Secure the lower edge of skirts and pants with a blind hem.

Memo

- When the size of cylindrical pieces is too small to slide onto the arm or the length is too short, the fabric will not feed and desired results may not be achieved.

1 Turn the skirt or pants inside out.

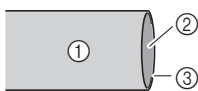

① Wrong side of fabric
② Right side of fabric
③ Lower edge of fabric

2 Fold the lower edge of fabric to the desired length to be hemmed and then press.

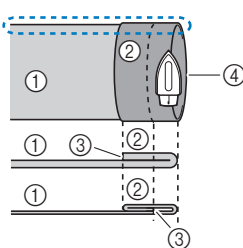

① Wrong side of fabric
② Right side of fabric
③ Lower edge of fabric
④ Desired length for hem

<Thick fabric>

<Normal fabric>

<Seen from the side>

3 Using tailor's chalk, mark the fabric about 5 mm (3/16 inch) from the edge of the fabric, and then baste it.

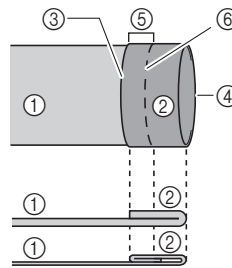

① Wrong side of fabric
② Right side of fabric
③ Lower edge of fabric
④ Desired length for hem
⑤ 5 mm (3/16 inch)
⑥ Basting

<Thick fabric>

<Normal fabric>

<Seen from the side>

4 Fold back the fabric inside along the basting.

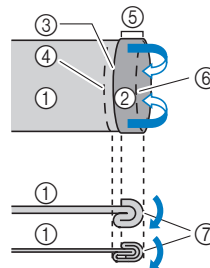

① Wrong side of fabric
② Right side of fabric
③ Lower edge of fabric
④ Desired length for hem
⑤ 5 mm (3/16 inch)
⑥ Basting
⑦ Basting point

<Thick fabric>

<Normal fabric>

<Seen from the side>

5 Unfold the edge of fabric, and position the fabric with the wrong side facing up.

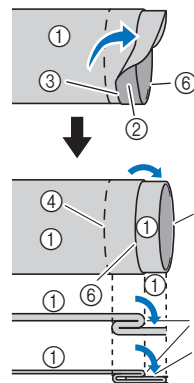

① Wrong side of fabric
② Right side of fabric
③ Edge of fabric
④ Desired edge of hem
⑤ Basting point
⑥ Basting

<Thick fabric>

<Normal fabric>

<Seen from the side>

6 Attach blind stitch foot "R".



7 Select a stitch.

Stitch	No.			
	80 stitches	60 stitches	50 stitches	16 stitches
	21	19	18	07
	22	20	19	08

• For details, refer to "Stitch Chart" on page 33.

- 8 Remove the flat bed attachment to use the free arm.
- 9 Slide the item that you wish to sew onto the free arm, make sure that the fabric feeds correctly, and then start sewing.

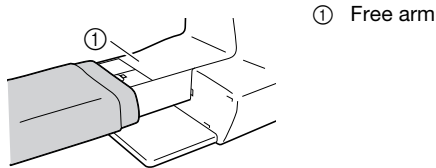

- 10 Position the fabric with the edge of the folded hem against the presser foot guide, and then lower the presser foot lever.

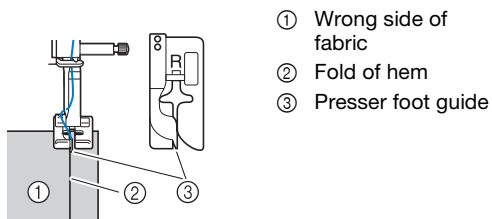

- 11 Adjust the stitch width until the needle slightly catches the fold of the hem. (page 27)

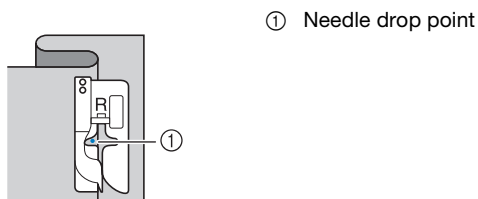

When you change the needle drop point, raise the needle, and then change the stitch width.

* To make fine adjustments to the needle drop point, adjust the stitch width setting. (The stitch width setting is in neither millimeters nor inches.)

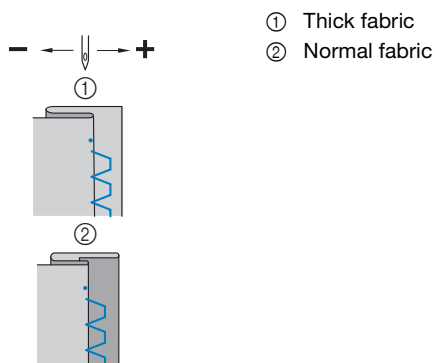

Memo

- Blind hem stitches cannot be sewn if the left needle drop point does not catch the fold. If the needle catches too much of the fold, the fabric cannot be unfolded and the seam appearing on the right side of the fabric will be very large, leaving an unattractive finish.

- 12 Sew with the fold of the hem against the presser foot guide.

- 13 Press the “Start/Stop” button to stop sewing when you are finished, and raise the presser foot and needle to pull the fabric under the presser foot towards the back of the machine.

Note

- Be sure to pull the fabric towards the back of the machine after sewing. If you pull the fabric toward side or forward, the presser foot may be damaged.

- 14 Remove the basting stitching and turn the fabric with the right side facing out.

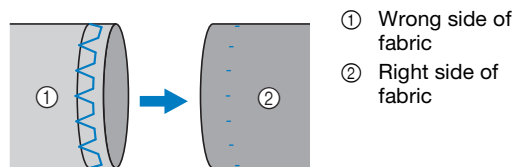

Buttonhole sewing

The maximum buttonhole length is about 28 mm (1-1/8 inches) (diameter + thickness of the button).

Buttonholes are sewn from the front of the presser foot to the back, as shown below.

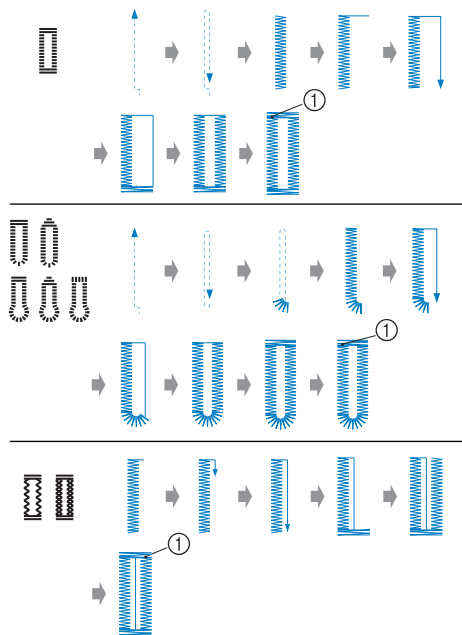

The part names of buttonhole foot "A", which is used to create buttonholes, are indicated below.

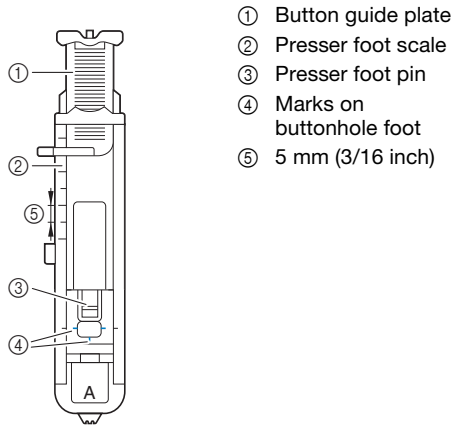

Note

- Before sewing buttonholes, check the stitch length and width by sewing a trial buttonhole on a scrap piece of fabric used for your project.

1 Use chalk to mark on the fabric the position and length of the buttonhole.

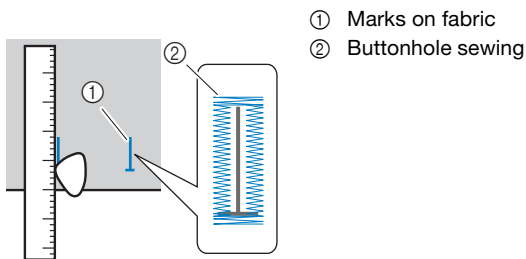

2 Pull out the button guide plate of buttonhole foot "A", and then insert the button that will be put through the buttonhole.

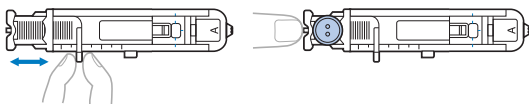

■ If the button does not fit in the button guide plate

Add together the diameter and thickness of the button, and then set the button guide plate to the calculated length. (The distance between the markings on the presser foot scale is 5 mm (3/16 inch).)

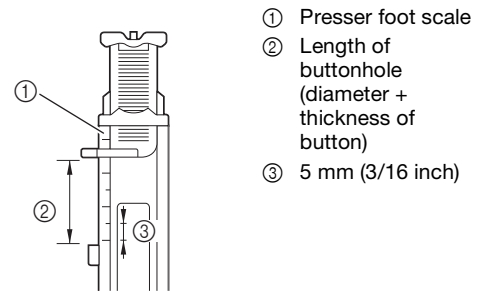

Example: For a button with a diameter of 15 mm (9/16 inch) and a thickness of 10 mm (3/8 inch), the button guide plate should be set to 25 mm (1 inch) on the scale.

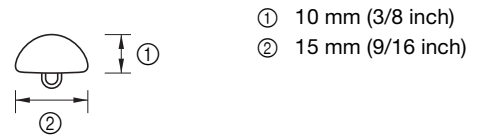

→ The size of the buttonhole is set.

3 Attach buttonhole foot "A".

Position the upper thread under the presser foot by guiding thread through the hole in the presser foot before attaching the buttonhole foot "A".

4 Select a stitch.

Stitch	No.			
	80 stitches	60 stitches	50 stitches	16 stitches
	42	39	37	15
	43	-	-	-
	44	40	38	14
	45	41	39	-
	46	42	40	-
	47	43	41	16
	48	44	-	-
	49	-	-	-

- For details, refer to "Stitch Chart" on page 33.

5 Position the fabric with the front end of the buttonhole mark aligned with the red marks on the sides of the buttonhole foot, and then lower the presser foot lever.

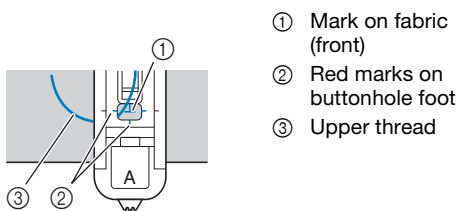

- ① Mark on fabric (front)
- ② Red marks on buttonhole foot
- ③ Upper thread

Note

- When lowering the presser foot, do not push in the front of the presser foot, otherwise the bar tack will not be sewn with the correct size.

Memo

- If there is difficulty in aligning the marks, slowly turn the handwheel toward you to check where the needle will enter the fabric, and then align the mark on the fabric with that point.

6 Pull down the buttonhole lever as far as possible.

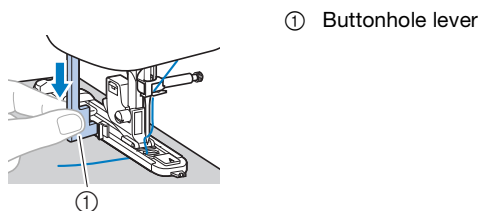

The buttonhole lever is positioned behind the bracket on the buttonhole foot.

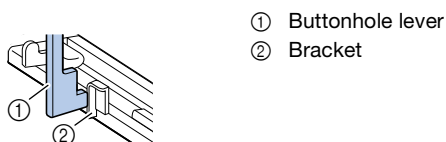

7 Gently hold the end of the upper thread in your left hand, and then start sewing.

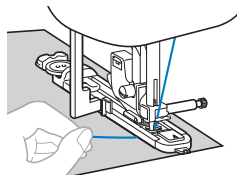

→ Once sewing is completed, the machine automatically sews reinforcement stitches, then stops.

8 Press **+** (Needle position button) to raise the needle, raise the presser foot, and then pull out the fabric before cutting the threads.

9 Raise the buttonhole lever to its original position.

10 Insert a pin along the inside of one bar tack at the end of the buttonhole stitching to prevent the stitching from being cut.

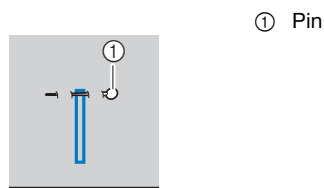

11 Use the seam ripper to cut towards the pin and open the buttonhole.

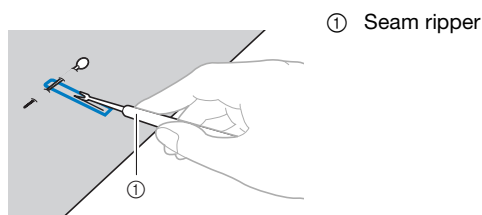

For keyhole buttonholes, use the eyelet punch to make a hole in the rounded end of the buttonhole, and then use the seam ripper to cut open the buttonhole.

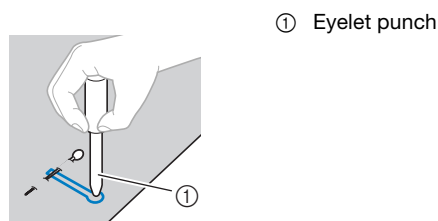

- When using the eyelet punch, place thick paper or some other protective sheet under the fabric before punching the hole in the fabric.

CAUTION

- When opening the buttonhole with the seam ripper, do not place your hands in the cutting direction, otherwise injuries may result if the seam ripper slips.
- Do not use the seam ripper in any other way than how it is intended.

■ Sewing buttonholes on stretch fabrics

When sewing buttonholes on stretch fabrics, use a gimp thread.

1 Hook the gimp thread onto the part of buttonhole foot "A" shown in the illustration.

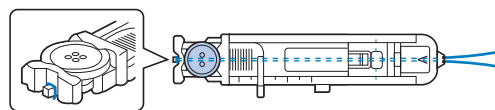

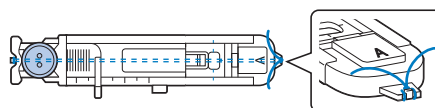

2 It fits into the grooves, and then loosely tie it.



3 Attach buttonhole foot "A".

4 Select a stitch.

Stitch	No.			
	80 stitches	60 stitches	50 stitches	16 stitches
	45	41	39	-
	46	42	40	-

• For details, refer to "Stitch Chart" on page 33.

5 Adjust the stitch width to the thickness of the gimp thread.

6 Lower the presser foot lever and the buttonhole lever, and then start sewing.

7 When sewing is finished, gently pull the gimp thread to remove any slack.

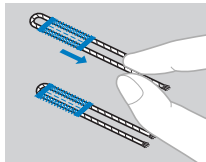

8 Use a handsewing needle to pull the gimp thread to the wrong side of the fabric, and then tie it.

Button sewing

Buttons can be sewn on with the machine. Buttons with two or with four holes can be attached.

1 Measure the distance between the holes in the button to be attached.



2 Raise the presser foot lever, and then slide the feed dog position switch, located at the rear of the machine on the base, to  (to the left as seen from the rear of the machine).

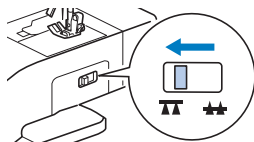

→ The feed dogs are lowered.

3 Attach button fitting foot "M".

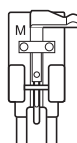

4 Select a stitch.

Stitch	No.			
	80 stitches	60 stitches	50 stitches	16 stitches
	07	07	07	04

• For details, refer to "Stitch Chart" on page 33.

5 Adjust the stitch width so that it is the same as the distance between the holes in the button.

6 Place the button in the position where it will be sewn, and lower the presser foot lever.

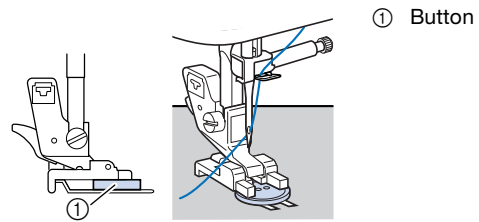

• When attaching four-hole buttons, first sew the two holes closest to you. Then, slide the button so that the needle goes into the two holes toward the rear of the machine, and then sew them in the same way.

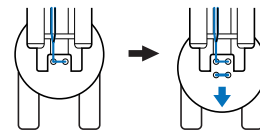

7 Turn the handwheel toward you (counterclockwise) to check that the needle correctly goes into the two holes of the button.

If it seems as if the needle will hit the button, remeasure the distance between the holes in the button. Adjust the stitch width to the distance between the button holes.

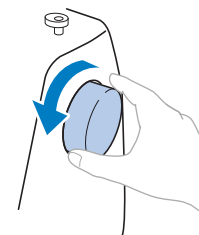

CAUTION

• When sewing, be sure that the needle does not touch the button, otherwise the needle may bend or break.

8 Sew about 10 stitches at a slow speed.

Set the sewing speed controller to the left (so that the speed will be slow).

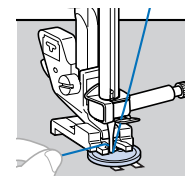

- 9** Use scissors to cut the upper thread and the bobbin thread at the beginning of the stitching.

Pull the upper thread at the end of the stitching to the wrong side of the fabric, and then tie it with the bobbin thread.

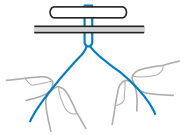

- 10** When you are finished attaching the button, slide the feed dog position switch, to  (to the right as seen from the rear of the machine) and turn the handwheel to raise the feed dogs.

Memo

- The feed dogs come up when you start sewing again.

Attaching a shank to a button

To sew the button with a shank, attach the button with space between it and the fabric, and then wind the thread by hand. This attaches the button securely.

- 1** Place the button into button fitting foot “M”, and then pull the shank lever toward you.

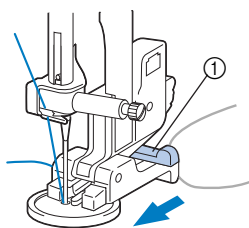

① Shank lever

- 2** After sewing is finished, cut the upper thread with plenty of excess, wind it around the thread between the button and the fabric, and then tie it to the upper thread at the beginning of the stitching.

Tie together the ends of the bobbin thread at the end and at the beginning of the stitching at the wrong side of the fabric.

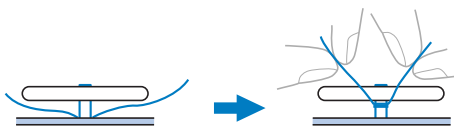

- 3** Cut off any excess thread.

Zipper Insertion

Inserting a centered zipper

Stitching is sewn on both pieces of fabric butted against each other.

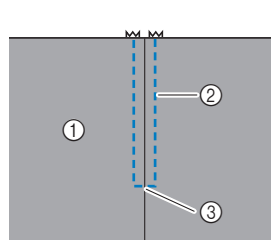

① Right side of fabric
② Stitching
③ End of zipper opening

- 1** Attach zigzag foot “J”.

- 2** Sew straight stitches up to the zipper opening.

With the right sides of the fabric facing each other, sew reverse stitches after reaching the zipper opening.

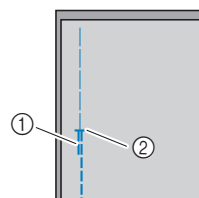

① Reverse stitches
② End of zipper opening

- 3** Using a basting stitch, continue sewing to the edge of the fabric.

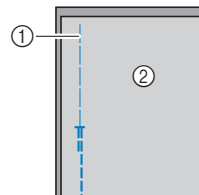

① Basting stitching
② Wrong side of fabric

- 4** Press open the seam allowance from the wrong side of the fabric.

① Wrong side of fabric

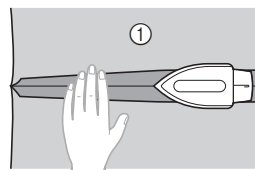

- 5** Align the seam with the center of the zipper, and then baste the zipper in place to the seam allowance.

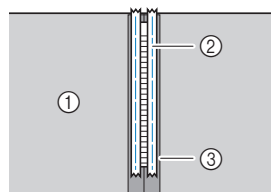

① Wrong side of fabric
② Basting stitching
③ Zipper

- 6** Remove about 5 cm (2 inches) from the end of the basting on the outside.

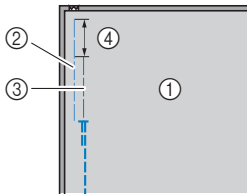

- ① Wrong side of fabric
- ② Zipper basting
- ③ Outside basting
- ④ 5 cm (2 inches)

- 7** Attach the presser foot holder to the right pin of zipper foot "I".

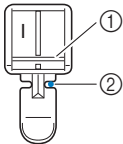

- ① Pin on the right side
- ② Needle drop point

- 8** Select a stitch.

Stitch	No.			
	80 stitches	60 stitches	50 stitches	16 stitches
	03	03	03	02

- For details, refer to "Stitch Chart" on page 33.

CAUTION

- When using zipper foot "I", be sure to select the straight stitch (middle (center) needle position), and slowly turn the handwheel toward you (counterclockwise) to check that the needle does not touch the presser foot. If a different stitch is selected or the needle hits the presser foot, the needle may bend or break.

- 9** Topstitch around the zipper.

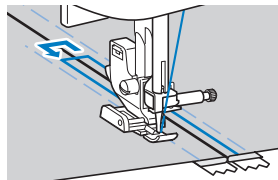
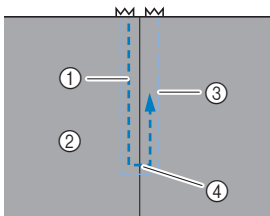

- ① Stitching
- ② Right side of fabric
- ③ Basting stitching
- ④ End of zipper opening

CAUTION

- When sewing, be sure that the needle does not touch the zipper, otherwise the needle may bend or break.

Memo

- If the presser foot contacts the zipper slider, leave the needle lowered (in the fabric) and raise the presser foot. After moving the slider so it will not contact the presser foot, lower the presser foot and continue sewing.

- 10** Remove the basting stitching.

Appliqué, Patchwork and Quilt Stitching

Appliqué stitching

- 1** Baste or glue the appliqué piece to the base fabric to secure it.

Note

- If glue is used to hold the appliqué in place on the fabric, do not apply glue to areas that will be sewn with the machine. If glue adheres to the needle or bobbin case, the machine may be damaged.

- 2** Attach the zigzag foot "J".

- 3** Select a stitch.

Stitch	No.			
	80 stitches	60 stitches	50 stitches	16 stitches
	18	16	16	*1
	19	17	-	-
	23	21	20	11
	24	22	21	-

- For details, refer to "Stitch Chart" on page 33.

*1 For the 16 stitches model, select stitch "04", and use the reinforcement stitch button. Do not use reverse stitching.

- Turn the handwheel toward you (counterclockwise), and then begin sewing around the edge of the appliqué, making sure that the needle drops just outside of the appliqué.

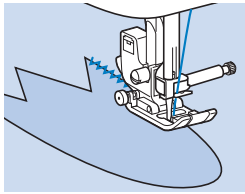

When sewing around corners, stop the machine with the needle in the fabric just outside of the appliqué, raise the presser foot lever, and then turn the fabric as needed to change the sewing direction.

■ Patchwork (crazy quilt) stitching

- Fold the edge of the top piece of fabric and place it over the lower piece.
- Attach zigzag foot "J".
- Select a stitch.
 - The stitches shown below are examples. Select the desired stitch.

Stitch	No.			
	80 stitches	60 stitches	50 stitches	16 stitches
	18	16	16	-*1
	27	25	24	-
	28	26	25	-
	29	27	26	-

- For details, refer to "Stitch Chart" on page 33.
- *1 For the 16 stitches model, select stitch "04", and use the reinforcement stitch button. Do not use reverse stitching and automatic reverse/reinforcement stitching.

- Sew the two pieces of fabric together so the stitch pattern spans over both pieces.
Use pins if necessary.

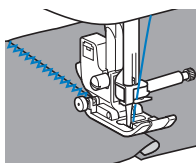

⚠ CAUTION

- Do not stitch over pins.

■ Piecing

Sewing together two pieces of fabric is called "piecing". The fabric pieces should be cut with a 6.5 mm (1/4 inch) seam allowance.

Sew a piecing straight stitch 6.5 mm (1/4 inch) from either the right side or the left side of the presser foot.

- Baste or pin along the seam allowance of the fabric that you wish to piece together.
- Attach zigzag foot "J".
- Select a stitch.

Stitch	No.			
	80 stitches	60 stitches	50 stitches	16 stitches
	15	14	14	-*1

- For details, refer to "Stitch Chart" on page 33.
- *1 For the 16 stitches model, select stitch "02", and use the reinforcement stitch button. Do not use reverse stitching and automatic reverse/reinforcement stitching.

- Sew with the side of the presser foot aligned with the edge of the fabric.

- For a seam allowance on the right side

Align the edge of the fabric with the right side of the presser foot, and set the stitch width 5.5 mm (7/32 inch)

and sew using stitch

① 6.5 mm (1/4 inch)

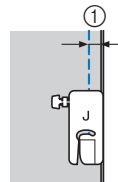

- For a seam allowance on the left side

Align the left side of the presser foot with the edge of the fabric, and set the stitch width 1.5 mm (1/16 inch) and

sew using stitch

① 6.5 mm (1/4 inch)

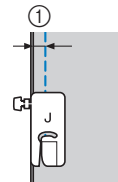

📝 Memo

- To change the width of the seam allowance (needle position), adjust the stitch width. For details, refer to "Setting the stitch width" on page 27 and "Sewing an even seam allowance" on page 29.

■ Quilting

Sandwiching batting between the top and bottom layers of fabric is called “quilting”. Quilts can easily be sewn using the walking foot* and the quilting guide*.

* Items sold separately, please contact your authorized Brother dealer.

Note

- Thread the needle manually when using the walking foot, or attach the walking foot only after threading the needle using the needle threader.
- When quilting, use a 90/14 home sewing machine needle.
- The walking foot can only be used with straight or zigzag stitch patterns. Do not sew reverse stitches with the walking foot.
- When sewing with the walking foot, sew at a speed between slow and medium.
- When using the walking foot, test sew on a scrap piece of fabric that is to be used in project.

1 Baste the fabric to be quilted.

2 Remove the presser foot and the presser foot holder.

- For details, refer to “Removing and attaching the presser foot holder” on page 22.

3 Hook the connecting fork of the walking foot onto the needle clamp screw.

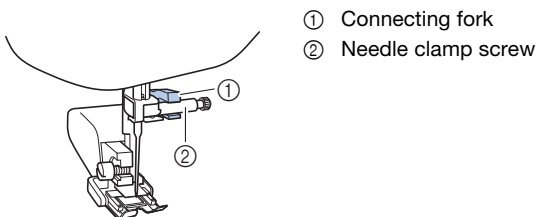

4 Lower the presser foot lever, and then tighten the presser foot holder screw with the screwdriver.

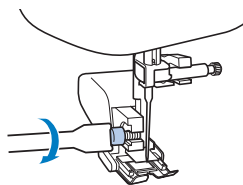

⚠ CAUTION

- Be sure to securely tighten the screws with the screwdriver, otherwise the needle may touch the presser foot, causing it to bend or break.
- Before starting to sew, slowly turn the handwheel toward you (counterclockwise) and check that the needle does not touch the presser foot. If the needle hits the presser foot, the needle may bend or break.

5 Select a stitch.

Stitch	No.			
	80 stitches	60 stitches	50 stitches	16 stitches
	04	04	04	_1
	18	16	16	_2

- For details, refer to “Stitch Chart” on page 33.

*1 For the 16 stitches model, select stitch “02”, and use the reinforcement stitch button. Do not use reverse stitching and automatic reverse/reinforcement stitching.

*2 For the 16 stitches model, select stitch “04”, and use the reinforcement stitch button. Do not use reverse stitching and automatic reverse/reinforcement stitching.

6 Place one hand on each side of the presser foot, and then evenly guide the fabric while sewing.

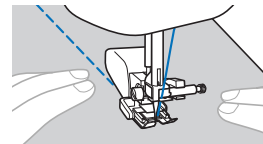

□ Using the quilting guide (sold separately)

Use the quilting guide to sew parallel stitches that are equally spaced.

1 Insert the stem of the quilting guide into the hole at the rear of the walking foot or presser foot holder.

□ Walking foot

□ Presser foot holder

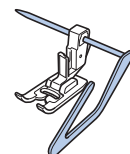

2 Adjust the stem of the quilting guide so that the guide aligns with the seam that has already been sewn.

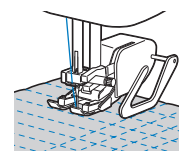

Free motion quilting

We recommend attaching the foot controller and sewing at a consistent speed. You can adjust the sewing speed with the speed control slide on the machine.

CAUTION

- With free motion quilting, control the feeding speed of the fabric to match the sewing speed. If the fabric is moved faster than the sewing speed, the needle may break or other damage may result.

The quilting foot* is used for free motion quilting with zigzag or decorative stitches or for free motion quilting of straight lines on fabric with an uneven thickness.

* Items sold separately, please contact your authorized Brother dealer.

Quilting foot

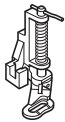

- Slide the feed dog position switch, located at the rear of the machine on the base, to (to the left as seen from the rear of the machine).

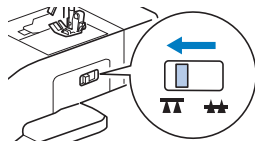

→ The feed dogs are lowered.

- Select a stitch.

Stitch	No.			
	80 stitches	60 stitches	50 stitches	16 stitches
	04	04	04	*1
	18	16	16	*2

• For details, refer to “Stitch Chart” on page 33.

*1 For the 16 stitches model, select stitch “02”, and use the reinforcement stitch button. Do not use reverse stitching and automatic reverse/reinforcement stitching.

*2 For the 16 stitches model, select stitch “04”, and use the reinforcement stitch button. Do not use reverse stitching and automatic reverse/reinforcement stitching.

- Remove the presser foot holder.

• For details, refer to “Removing and attaching the presser foot holder” on page 22.

- Attach the quilting foot by positioning the pin of the quilting foot above the needle clamp screw and aligning the lower-left of the quilting foot and the presser bar.

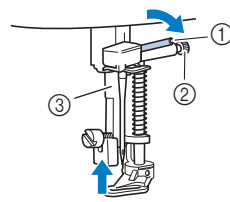

- ① Pin
- ② Needle clamp screw
- ③ Presser bar

Note

- Make sure that the quilting foot is not slanted.

- Hold the quilting foot in place with your right hand, and tighten the presser foot holder screw using the screwdriver with your left hand.

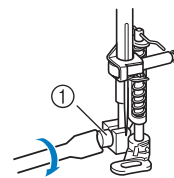

- ① Presser foot holder screw

CAUTION

- Be sure to securely tighten the screws with the included screwdriver. Otherwise, the needle may touch the quilting foot, causing it to bend or break.

- Use both hands to stretch the fabric taut, and then move the fabric at a consistent pace in order to sew uniform stitches roughly 2.0 mm - 2.5 mm (approx. 1/16 inch - 3/32 inch) in length.

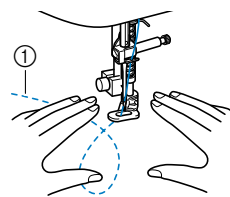

- ① Stitch

- After sewing is finished, slide the feed dog position switch lever to (to the right as seen from the rear of the machine) and turn the handwheel to raise the feed dogs.

Other Stitching Applications

■ Elastic attaching

When elastic tape is attached to the cuff or waist of a piece of clothing, the finished dimensions will be that of the stretched elastic tape. Therefore, it is necessary that a suitable length of the elastic tape be used.

1 Pin the elastic tape to the wrong side of the fabric.

Pin the elastic tape to the fabric at a few points to make sure that the tape is uniformly positioned on the fabric.

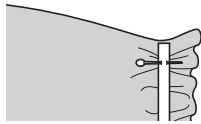

2 Attach zigzag foot "J".

3 Select a stitch.

Stitch	No.			
	80 stitches	60 stitches	50 stitches	16 stitches
	10	09	09	09

• For details, refer to "Stitch Chart" on page 33.

4 Sew the elastic tape to the fabric while stretching the tape so that it is the same length as the fabric.

While pulling the fabric behind the presser foot with your left hand, pull the fabric at the pin nearest the front of the presser foot with your right hand.

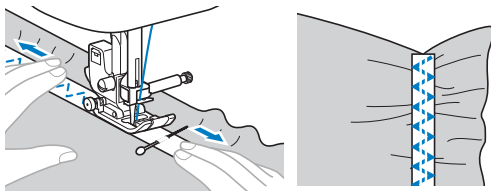

⚠ CAUTION

- When sewing, be sure that the needle does not touch any pins, otherwise the needle may bend or break.

■ Bar tack stitching

Bar tacks are used to reinforce points subject to strain, such as pocket corners and openings.

As an example, the procedure for sewing bar tacks at pocket corners is described below.

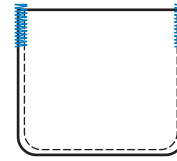

1 Determine the desired length of the bar tack.

Set the button guide plate on buttonhole foot "A" to the desired length. (The distance between the markings on the presser foot scale is 5 mm (3/16 inch).)

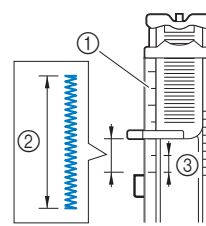

- ① Presser foot scale
- ② Length of bar tack
- ③ 5 mm (3/16 inch)

- A bar tack with a maximum length of about 28 mm (1-1/8 inches) can be sewn.

2 Attach buttonhole foot "A".

Position the upper thread under the presser foot by guiding thread through the hole in the presser foot before attaching the buttonhole foot "A".

3 Select a stitch.

Stitch	No.			
	80 stitches	60 stitches	50 stitches	16 stitches
	50	45	42	13

• For details, refer to "Stitch Chart" on page 33.

4 Position the fabric so that the opening of the pocket faces toward you, and then lower the presser foot lever so that the needle drops 2 mm (1/16 inch) in front of the pocket opening.

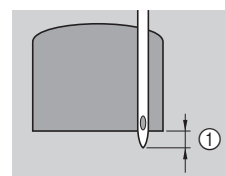

- ① 2 mm (1/16 inch)

5 Pull down the buttonhole lever as far as possible.

6 Gently hold the end of the upper thread in your left hand, and then start sewing.

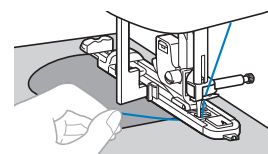

- 7 After sewing is finished, raise the presser foot lever, remove the fabric, and then cut the threads.
- 8 Raise the buttonhole lever to its original position.

■ Fagoting

Stitching across an open seam is called “fagoting”. It is used on blouses and children’s clothing. This stitch is more decorative when thicker thread is used.

- 1 Use an iron to fold the two pieces of fabric along their seams.
- 2 Baste the two pieces of fabric, separated by about 4 mm (3/16 inch), onto thin paper or a sheet of water soluble stabilizer.

If you draw a line down the middle of the thin paper, or water soluble stabilizer, sewing is easier.

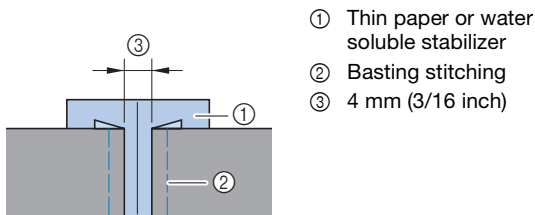

- ① Thin paper or water soluble stabilizer
- ② Basting stitching
- ③ 4 mm (3/16 inch)

- 3 Attach zigzag foot “J”.
- 4 Select a stitch.

Stitch	No.			
	80 stitches	60 stitches	50 stitches	16 stitches
	31	29	28	12
	32	30	29	-

• For details, refer to “Stitch Chart” on page 33.

- 5 Set the stitch width to 7.0 mm (1/4 inch).
- 6 Sew with the center of the presser foot aligned along the center of the two pieces of fabric.

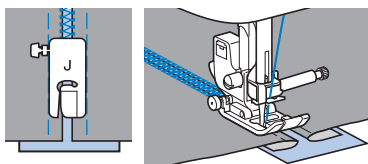

- 7 After sewing is finished, remove the paper.

■ Scallop stitching

The wave-shaped repeated stitch pattern that looks like shells is called “scalloping”. It is used on the collars of blouses and to decorate the edges of projects.

- 1 Attach monogramming foot “N”.
- 2 Select a stitch.

Stitch	No.			
	80 stitches	60 stitches	50 stitches	16 stitches
	26	24	23	-

• For details, refer to “Stitch Chart” on page 33.

- 3 Stitch along the edge of the fabric, making sure not to sew directly on the edge of the fabric.

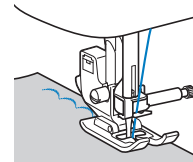

- 4 Trim along the stitches.

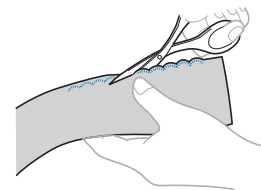

• Be careful not to cut the stitches.

■ Smocking

The decorative stitch created by stitching or embroidering over gathers is called “smocking”. It is used to decorate the front of blouses or cuffs.



The smocking stitch adds texture and elasticity to fabric.

- 1 Attach zigzag foot “J”.
- 2 Select the straight stitch, and then adjust the stitch length to 4.0 mm (3/16 inch) and loosen the thread tension.
- 3 Sew parallel stitching at intervals of 1 cm (3/8 inch) and pull the bobbin threads to create gathers.

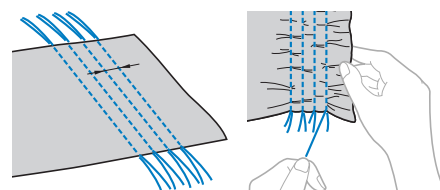
Smooth the gathers by ironing them.



4 Select a stitch.

Stitch	No.			
	80 stitches	60 stitches	50 stitches	16 stitches
	30	28	27	-
	31	29	28	12
	32	30	29	-

• For details, refer to "Stitch Chart" on page 33.

5 Stitch between the straight stitches and pull out the threads for the straight stitches.

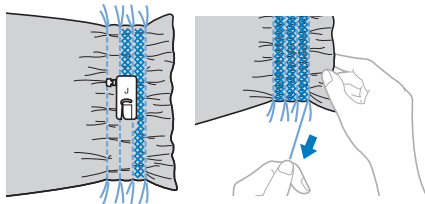

■ Shell tuck stitching

The gathers that look like shells are called "shell tucks". They are used to decorate trims, the front of blouses or cuffs made of thin fabrics.

1 Draw equally spaced lines along the bias, and then fold the fabric along the lines.

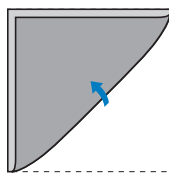

2 Attach zigzag foot "J".

3 Select a stitch, and then increase the thread tension.

Stitch	No.			
	80 stitches	60 stitches	50 stitches	16 stitches
	25	23	22	-

• For details, refer to "Stitch Chart" on page 33.

4 Sew while making sure that the needle drops slightly off the edge of the fabric.

One fold at a time, continue folding the fabric along the line, then sewing it.

① Needle drop point

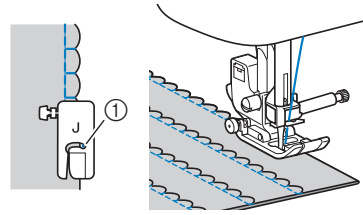

5 After sewing is finished, remove the fabric. Unfold the fabric, and then iron the tucks down to one side.



■ Joining

Decorative bridging stitches can be sewn over the seam allowance of joined fabrics. This is used when making a crazy quilt.

1 Attach zigzag foot "J".

2 Sew together the right sides of the two pieces of fabric, and then open up the seam allowances.

3 Select a stitch.

Stitch	No.			
	80 stitches	60 stitches	50 stitches	16 stitches
	27	25	24	-
	28	26	25	-
	29	27	26	-

• For details, refer to "Stitch Chart" on page 33.

4 Turn the fabric over so that the right side faces up, and then sew over the seam with the center of the presser foot aligned with the seam.

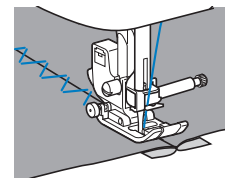

■ Using the twin needle

With the twin needle, you can sew two parallel lines of the same stitch with two different threads. Both upper threads should have the same thickness and quality.

The procedure for using the twin needle differs depending on the model.

⚠ CAUTION

- Only use the twin needle (2/11 needle, part code: X59296-121), and never use the needle threader with the twin needle. Otherwise, the needle may break or the machine may be damaged.
- (For models not equipped with a needle mode selection key)
For stitch patterns that can use the twin needle, refer to the “Stitch Chart” on page 33. After specifying the settings, turn the handwheel toward you and check that the needle does not touch the presser foot.

1 Install the twin needle.

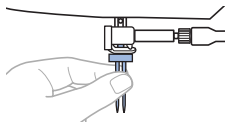

- For details on installing a needle, refer to “Replacing the Needle” on page 20.

2 Pass the first upper thread behind the needle bar thread guide.

- For details, refer to steps 1 through 10 of “Threading the upper thread” on page 15.

3 Manually thread the left needle with the first upper thread.

Insert the thread through the eye of the needle from the front to the back.

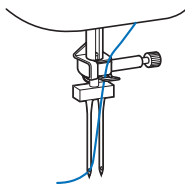

4 Put the extra spool pin in the hole on the top of the machine and put the spool of thread onto the extra spool pin.

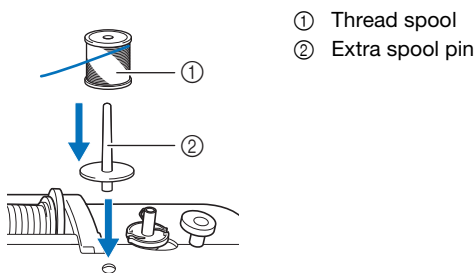

5 Thread the machine with the second upper thread. Without passing the thread behind the needle bar thread guide, manually thread the right needle with the second upper thread.

Insert the thread through the eye of the needle from the front to the back.

① Needle bar thread guide

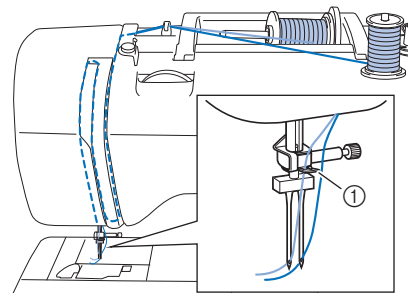

6 Attach zigzag foot “J”.

- For details on changing the presser foot, refer to “Replacing the presser foot” on page 21.

⚠ CAUTION

- When using the twin needle, be sure to attach zigzag foot “J”.

7 Turn on the machine.

8 Select a stitch.

- For stitch selection refer to “Basic sewing” on page 23.
- Refer to “Stitch Chart” on page 33 for stitches that can be sewn with a twin needle. You can also sew with a twin needle when you select a satin stitch pattern. In this case, use zigzag foot “J”.

⚠ CAUTION

- When using the twin needle, be sure to select an appropriate stitch, otherwise the needle may break or the machine may be damaged.

9 Set the machine to use the twin needle setting. The setting procedure differs depending on the model.

- For models equipped with a needle mode selection key
Press (Needle mode selection key).

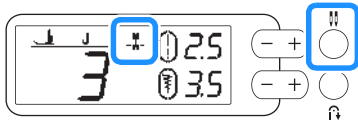

→ The twin needle mode is selected.

CAUTION

- When using the twin needle, be sure to select the twin needle setting, otherwise the needle may break or the machine may be damaged.

- For models not equipped with a needle mode selection key

When the following stitch is selected, set the stitch width between 1.0 mm (1/16 inch) and 6.0 mm (15/64 inch).

No.	02
Stitch	

When any of the following stitches is selected, set the stitch width to 5.0 mm (3/16 inch) or less.

No.	03	04	09	11	12
Stitch					

After specifying the settings, turn the handwheel toward you and check that the needle does not touch the presser foot.

10 Start sewing.

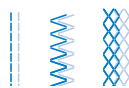

CAUTION

- Do not try turning the fabric while the twin needle is down in the fabric, otherwise the needle may break or the machine may be damaged.
- If bunched stitches occur, use monogramming foot "N" (for 80/60/50 stitches models) or attach stabilizer material.

Heirloom stitching

When sewing with the wing needle, the needle holes are enlarged, creating a lace-like decorative stitch. This is used to decorate hems and tablecloths on thin or medium weight fabrics in addition to plain weave fabrics. (Only for models that include monogramming foot "N")

1 Install the wing needle.



- Use a 130/705H 100/16 wing needle.
- For details on installing a needle, refer to "Replacing the needle" on page 20.
- The needle threader cannot be used with the wing needle, otherwise the machine may be damaged. Manually pass the thread through the eye of the needle from the front to the back.

2 Attach monogramming foot "N".

3 Select a stitch.

Stitch	No.			
	80 stitches	60 stitches	50 stitches	16 stitches
	37	35	34	-
	38	36	35	-
	40	37	36	-
	41	38	-	-

- For details, refer to "Stitch Chart" on page 33.

CAUTION

- When sewing with the wing needle, select a stitch width of 6.0 mm (15/64 inch) or less, otherwise the needle may bend or break.
- After adjusting the stitch width, slowly turn the handwheel toward you (counterclockwise) and check that the needle does not touch the presser foot. If the needle hits the presser foot, the needle may bend or break.

4 Start sewing.

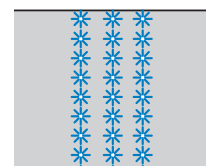

Making adjustments (For 80/60/50 stitches models)

Your stitch pattern may sometimes turn out poorly, depending on the type or thickness of fabric, the stabilizer material used, sewing speed, etc. If your sewing does not turn out well, sew trial stitches using the same conditions as the real sewing, and adjust the stitch pattern as explained below. If the stitch pattern does not turn out well even after making adjustments based on the stitch pattern described below, make adjustments for each stitch pattern individually.

Memo

- This adjustment can be made to  (Quilting stippling stitch), decorative stitches, decorative satin stitches, satin stitches and cross stitch stitches. For details on the built-in stitch patterns, refer to “Stitch Chart” on page 33.

1 Turn the stitch pattern selection dial to select  (--).

2 Attach monogramming foot “N” and sew the stitch pattern.

Note

- Be sure to use monogramming foot “N”. Adjustments may not be made correctly with any other presser foot.

3 Compare the finished stitch pattern to the illustration of the correct stitch pattern below.

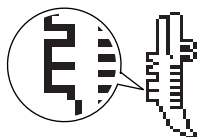

4 Adjust the stitch pattern with the stitch length keys.

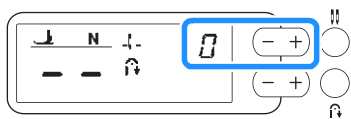

If the stitch pattern is bunched:
Press the “+” stitch length key.

→ The displayed value increases each time the button is pressed and the stitch pattern will lengthen.

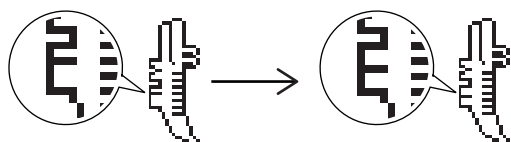

If the stitch pattern has gaps:
Press the “-” stitch length key.

→ The displayed value decreases each time the button is pressed and the stitch pattern will shorten.

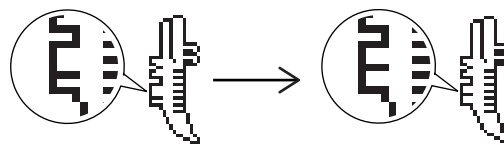

5 Sew the stitch pattern again.

- If the stitch pattern still comes out poorly, make adjustments again. Adjust until the stitch pattern comes out correctly.

Note

- Sewing speed controller cannot be used with this stitch pattern.

Chapter 4 APPENDIX

Care and Maintenance

⚠ CAUTION

- **Unplug the power cord before cleaning the machine, otherwise injuries or an electric shock may occur.**

If the surface of the machine is dirty, lightly soak a cloth in neutral detergent, squeeze it out firmly, and then wipe the surface of the machine. After cleaning it once with a damp cloth, wipe it again with a dry cloth.

If the screen is dirty, gently wipe it with a soft, dry cloth. Do not wipe the LCD screen with a damp cloth. Do not use organic solvents or detergents.

Restrictions on oiling

In order to prevent damaging this machine, it must not be oiled by the user.

This machine was manufactured with the necessary amount of oil applied to ensure correct operation, making periodic oiling unnecessary.

If problems occur, such as difficulty turning the handwheel or an unusual noise, immediately stop using the machine, and contact your authorized Brother dealer or the nearest Brother authorized service center.

Precautions on storing the machine

Do not store the machine in any of the locations described below, otherwise damage to the machine may result, for example, rust caused by condensation.

- Exposed to extremely high temperatures
- Exposed to extremely low temperatures
- Exposed to extreme temperature changes
- Exposed to high humidity or steam
- Near a flame, heater or air conditioner
- Outdoors or exposed to direct sunlight
- Exposed to extremely dusty or oily environments

Note

- In order to extend the life of this machine, periodically turn it on and use it. Storing this machine for an extended period of time without using it may reduce its efficiency.

Cleaning the race

Sewing performance will suffer if lint and dust collects in the bobbin case, therefore, it should be cleaned regularly.

- 1 Press  (Needle position button) to raise the needle.
- 2 Turn off the machine.
- 3 Unplug the power cord from the power supply jack on the right side of the machine.
- 4 Raise the presser foot to remove the needle, presser foot and presser foot holder.
 - For details, refer to “Replacing the Needle” on page 20 and “Replacing the Presser Foot” on page 21.
- 5 Remove the flat bed attachment if it is attached.
- 6 Remove the bobbin cover.
- 7 Place the index finger of your right hand near the bottom of the latch on the needle plate cover. Insert the tip of the index finger of your left hand into the notch at the back of the needle plate cover. Place the thumb of your left hand at the front of the needle plate cover.

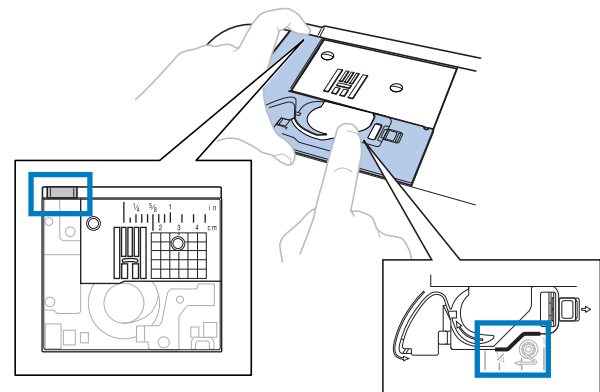

- 8 Slide the needle plate cover toward you to remove it.

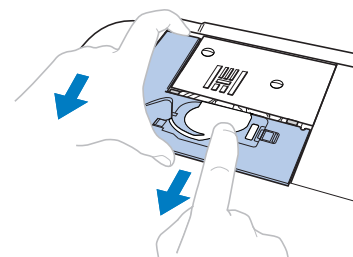

9 Grasp the bobbin case, and then pull it out.

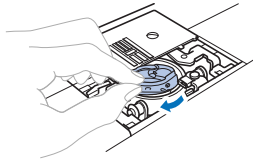

10 Use the cleaning brush or a vacuum cleaner to remove any lint and dust from the race and the surrounding area.

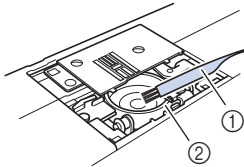

- ① Cleaning brush
- ② Race

- Do not apply oil to the bobbin case.

11 Insert the bobbin case so that the ▲ mark on the bobbin case aligns with the ● mark on the machine.

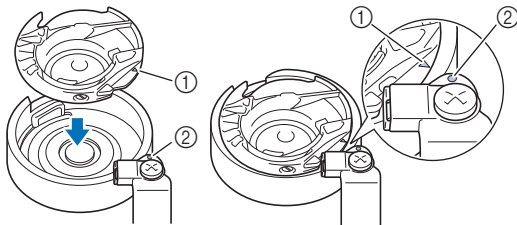

- Align the ▲ and ● marks.

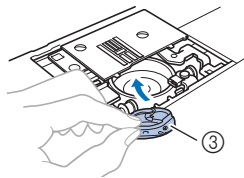

- ① ▲ mark
- ② ● mark
- ③ Bobbin case

- Make sure that the indicated points are aligned before installing the bobbin case.

12 Insert the tabs on the needle plate cover into the needle plate, and then slide the cover back on.

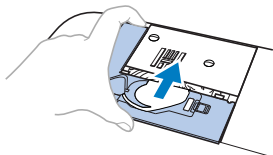

13 Reattach the bobbin cover.

⚠ CAUTION

- Never use a bobbin case that is scratched, otherwise the upper thread may become tangled, the needle may break or sewing performance may suffer. For a new bobbin case, contact your nearest Brother authorized service center.
- Be sure that the bobbin case is correctly installed, otherwise the needle may break.

Troubleshooting

If the machine stops operating correctly, check the following possible problems before requesting service. You can solve most problems by yourself. If you need additional help, the Brother Solutions Center offers the latest FAQs and troubleshooting tips. Visit us at “ <http://s.brother/cpjah/> ”.

If the problem persists, contact your Brother dealer or the nearest Brother authorized service center.

■ Frequent troubleshooting topics

Detailed causes and remedies for common troubleshooting topics are described below. Be sure to refer to this before contacting us.

Upper thread tightened up	page 57
Tangled thread on wrong side of fabric	page 57
Incorrect thread tension	page 58
Fabric is caught in the machine and cannot be removed	page 59
If the thread becomes tangled under the bobbin winder seat	page 61

Upper thread tightened up

■ Symptom

- The upper thread appears as a single continuous line.
- The bobbin thread is visible from the right side of the fabric. (Refer to the illustration below.)
- The upper thread has tightened up, and comes out when pulled.
- The upper thread has tightened up, and wrinkles appear in the fabric.
- The upper thread tension is tight, and the results do not change even after the thread tension is adjusted.

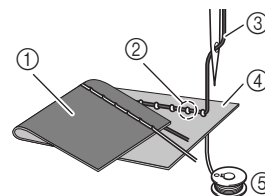

- ① Wrong side of fabric
- ② Bobbin thread visible from right side of fabric
- ③ Upper thread
- ④ Right side of fabric
- ⑤ Bobbin thread

■ Cause

Incorrect bobbin threading

If the bobbin thread is incorrectly threaded, instead of the appropriate tension being applied to the bobbin thread, it is pulled through the fabric when the upper thread is pulled up. For this reason, the thread is visible from the right side of the fabric.

■ Remedy/check details

Correctly install the bobbin thread. (page 14)

Tangled thread on wrong side of fabric

■ Symptom

- The thread becomes tangled on the wrong side of the fabric.

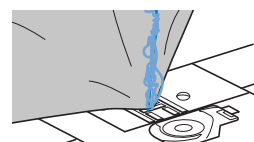

- After starting sewing, a rattling noise is made and sewing cannot continue.
- Looking under the fabric, there is tangled thread in the bobbin case.

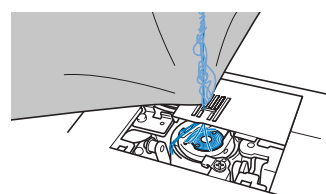

■ Cause

Incorrect upper threading

If the upper thread is incorrectly threaded, the upper thread passed through the fabric cannot be firmly pulled up and the upper thread becomes tangled in the bobbin case, causing a rattling noise.

■ Remedy/check details

Remove the tangled thread, and then correct the upper threading.

- 1 **Remove the tangled thread. If it cannot be removed, cut the thread with scissors.**
 - For details, refer to “Cleaning the race” on page 55.
- 2 **Remove the upper thread from the machine.**
- 3 **Correct the upper threading by following the instructions in “Threading the upper thread” on page 15.**
 - If the bobbin was removed from the bobbin case, refer to “Installing the bobbin” on page 14 to correctly install the bobbin.

Incorrect thread tension

■ Symptoms

- Symptom 1: The bobbin thread is visible from the right side of the fabric. (Refer to illustration below)
- Symptom 2: The upper thread appears as a straight line on the right side of the fabric.
- Symptom 3: The upper thread is visible from the wrong side of the fabric. (Refer to illustration below)
- Symptom 4: The bobbin thread appears as a straight line on the wrong side of the fabric.
- Symptom 5: The stitching on the wrong side of the fabric is loose or has slack.

□ Symptom 1

□ Symptom 3

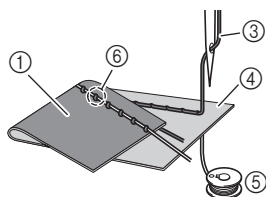
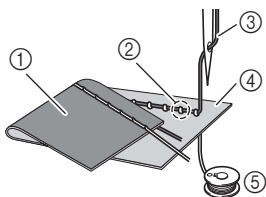

- ① Wrong side of fabric
- ② Bobbin thread visible from right side of fabric
- ③ Upper thread
- ④ Right side of fabric
- ⑤ Bobbin thread
- ⑥ Upper thread visible from wrong side of fabric

■ Cause/remedy/check details

□ Cause 1

The machine is not correctly threaded.

<With symptoms 1 and 2 described above>

The bobbin threading is incorrect.

Return the thread tension dial to “4”, and then refer to “Upper thread tightened up” on page 57 to correct the threading.

<With symptoms 3 and 5 described above>

The upper threading is incorrect.

Return the thread tension dial to “4”, and then refer to “Tangled thread on wrong side of fabric” on page 57 to correct the upper threading.

□ Cause 2

A needle and thread appropriate for the fabric are not being used.

The machine needle that should be used depends on the type of fabric sewn and the thread thickness.

If a needle and thread appropriate for the fabric are not being used, the thread tension will not be adjusted correctly, causing wrinkles in the fabric or skipped stitches.

- Refer to “Fabric/Thread/Needle Combinations” on page 19 to check that a needle and thread appropriate for the fabric are being used.

□ Cause 3

An appropriate upper tension is not selected.

Select an appropriate thread tension.

Refer to “Adjusting the thread tension” on page 27.

The appropriate thread tension differs depending on the type of fabric and thread being used.

- * Adjust the thread tension while test sewing on a piece of scrap fabric that is the same as that used in your project.

Note

- If the upper threading and bobbin threading are incorrect, the thread tension cannot be adjusted correctly. Check the upper threading and bobbin threading first, and then adjust the thread tension.

- **If the bobbin thread is visible from the right side of the fabric**

Turn the thread tension dial counterclockwise to loosen the upper thread tension.



- **If the upper thread is visible from the wrong side of the fabric**

Turn the thread tension dial clockwise to tighten the upper thread tension.



Fabric is caught in the machine and cannot be removed

If the fabric is caught in the machine and cannot be removed, the thread may have become tangled under the needle plate. Follow the procedure described below to remove the fabric from the machine. If the operation cannot be completed according to this procedure, instead of attempting to remove it forcefully, contact your nearest Brother authorized service center.

■ Removing the fabric from the machine

- 1 **Immediately stop the machine.**
- 2 **Turn off the machine.**
- 3 **Remove the needle.**
If the needle is lowered into the fabric, turn the handwheel away from you (clockwise) to raise the needle out of the fabric, and then remove the needle.
 - Refer to "Replacing the Needle" on page 20.
- 4 **Remove the presser foot and presser foot holder.**
If the thread is entangled on the presser foot, remove the entangled thread, and then raise the presser foot lever to remove the presser foot. Otherwise, the presser foot may be damaged.
 - Refer to "Replacing the Presser Foot" on page 21.
- 5 **Lift up the fabric and cut the threads below it.**
If the fabric can be removed, remove it. Continue with the following steps to clean the race.
 - Refer to "Cleaning the Race" on page 55.
- 6 **Remove the needle plate cover.**
 - Refer to "Cleaning the race" on page 55.
- 7 **Cut out the tangled threads, and then remove the bobbin.**

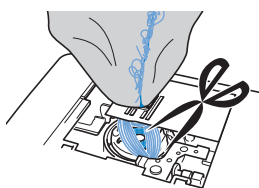

- 8 **Remove the bobbin case.**
If threads remain in the bobbin case, remove them.

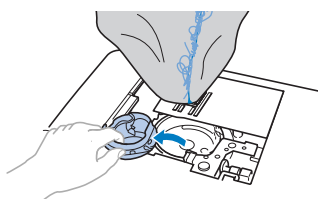

- 9 **Use the cleaning brush or a vacuum cleaner mini attachment to remove any lint or dust from the race and its surrounding area.**

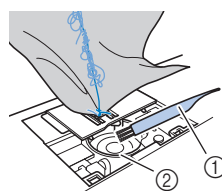

- ① Cleaning brush
- ② Race

If the fabric could be removed.	Continue with step 16.
If the fabric could not be removed.	Continue with step 10.

Note

- Compressed can air is not recommended to be used.

- 10 **Use the included disc-shaped screwdriver to loosen the two screws on the needle plate.**

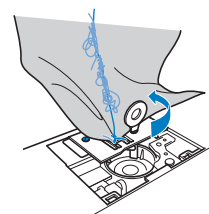

Note

- Be careful not to drop the removed screws in the machine.

- 11 **Slightly lift up the needle plate, cut any tangled threads, and then remove the needle plate.**
Remove the fabric and threads from the needle plate.

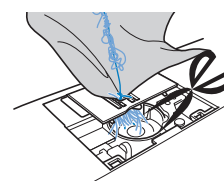

If the fabric cannot be removed, even after completing these steps, contact your nearest Brother authorized service center.

- 12 Remove any threads in the race and around the feed dogs.
- 13 Turn the handwheel to raise the feed dogs.
- 14 Align the two screw holes in the needle plate with the two holes at the needle plate mounting base, and then fit the needle plate onto the machine.
- 15 Lightly finger-tighten the screw on the right side of the needle plate. Then, use the disc-shaped screwdriver to firmly tighten the screw on the left side. Finally, firmly tighten the screw on the right side.

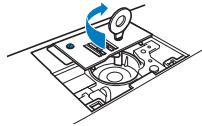

Turn the handwheel to check that the feed dogs move smoothly and do not contact the edges of the slots in the needle plate.

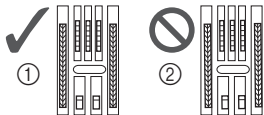

- ① Correct position of feed dogs
- ② Incorrect position of feed dogs

- 16 Insert the bobbin case by following step 11 in “Cleaning the race” on page 55.
- 17 Attach the needle plate cover according to step 12 in “Cleaning the race” on page 55.
- 18 Check the condition of the needle, and then install it.
If the needle is in a poor condition, for example, if it is bent, be sure to install a new needle.
 - Refer to “Checking the needle” on page 20 and “Replacing the needle” on page 20.

Memo

- Since the needle may have been damaged when the fabric was caught in the machine, we recommend replacing it with a new one.

■ Checking machine operations

If the needle plate has been removed, check machine operations to confirm that installation has been completed correctly.

- 1 Turn on the machine.

- 2 Select stitch .

Note

- Do not yet install the presser foot and thread.

- 3 Slowly turn the handwheel toward you (counterclockwise), and look from all sides to check that the needle falls at the center of the opening in the needle plate.

If the needle contacts the needle plate, remove the needle plate, and then install it again, starting with step 13 in “Removing the fabric from the machine” on page 59.

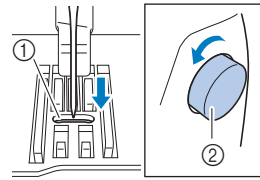

- ① Opening in the needle plate
- ② Handwheel

- 4 Select stitch . At this time, increase the stitch length and width to their maximum settings.

- For details on changing the settings, refer to “Setting the stitch width” on page 27 and “Setting the stitch length” on page 27.

- 5 Slowly turn the handwheel toward you (counterclockwise) and check that the needle bar and feed dogs operate correctly.

If the needle or feed dogs contact the needle plate, the machine may be malfunctioning; therefore, contact your nearest Brother authorized service center.

- 6 Turn off the machine, and then install the bobbin and presser foot.

Never use a scratched or damaged presser foot. Otherwise, the needle may break, or sewing performance may suffer.

- Refer to “Installing the bobbin” on page 14 and “Replacing the presser foot” on page 21.

- 7 Correctly thread the machine.

- For details on threading the machine, refer to “Upper Threading” on page 15.

- 8 Perform trial sewing with cotton fabric.

Note

- Incorrect sewing may be the result of incorrect upper threading or sewing thin fabrics. If there are poor results from the trial sewing, check the upper threading or the type of fabric being used.

If the thread becomes tangled under the bobbin winder seat

If the bobbin winding starts when the thread is not passed under the pretension disk of the bobbin-winding thread guide correctly, the thread may become tangled under the bobbin winder seat.

⚠ CAUTION

- Do not remove the bobbin winder seat even if the thread become tangled under the bobbin winder seat. Otherwise, the cutter in the bobbin winder seat may be damaged.
- Do not remove the screw on the bobbin winder guide post, otherwise the machine may be damaged; you cannot wind off the thread by removing the screw.

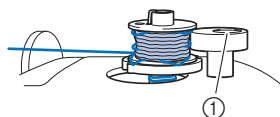

① Screw of the bobbin winder guide post

- 1 Stop the bobbin winding.
- 2 Cut the thread with scissors beside the bobbin-winding thread guide.
- 3 Slide the bobbin winder shaft to the left, and then remove the bobbin from the shaft and cut the thread leading to the bobbin in order to be able to completely remove the bobbin from shaft.
- 4 Hold the thread end with your left hand, and wind off the thread clockwise from under the bobbin winder seat with your right hand as shown below.

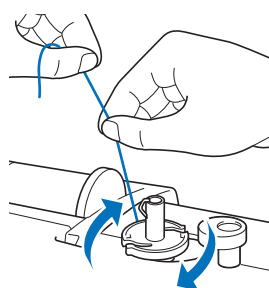

List of symptoms

Check the following possible problems before requesting service. If the reference page is “*”, contact your authorized Brother dealer or the nearest Brother authorized service center.

■ Getting ready

Symptom, Cause/solution	Reference
Cannot thread the needle.	
Needle is not in the correct position. <ul style="list-style-type: none"> • Press the “Needle position” button to raise the needle. 	6
Needle is installed incorrectly.	20
Needle is turned, bent or the point is dull.	20
Upper threading is incorrect. The needle threader lever is not lowered until it clicks.	15
The needle threader hook is bent and does not pass through the eye of the needle.	*
The needle threader lever cannot be moved or returned to its original position.	*
A size 65/9 needle is being used. <ul style="list-style-type: none"> • The needle is incompatible with the needle threader. Manually pass the thread through the eye of the needle. 	17
Bobbin thread does not wind neatly on the bobbin.	
The thread is not passed through the bobbin winding thread guide correctly.	12
The thread that was pulled out from the bobbin-winding thread guide was incorrectly wound onto the bobbin.	13
The empty bobbin was not set on the pin properly.	12
While winding the bobbin, the bobbin thread was wound below the bobbin winder seat.	
The thread was incorrectly passed under the pretension disk on the bobbin-winding thread guide. <ul style="list-style-type: none"> • Remove any entangled thread, and then wind the bobbin. 	12, 61
The bobbin thread cannot be pulled up.	
Needle is turned, bent or the point is dull.	20
Bobbin is set incorrectly.	14
Nothing appears in the LCD.	
Main power switch is not turned on.	9
The plug of the power cord is not inserted into an electrical outlet.	9

Symptom, Cause/solution	Reference
The sewing lamp does not come on.	
The sewing light is damaged. • Contact your authorized Brother dealer or the nearest Brother authorized service center.	–
The LCD screen is fogged up.	
Condensation has formed on the LCD screen. • After a while, the cloudiness will disappear.	–

■ While sewing

Symptom, Cause/solution	Reference
Machine does not operate.	
“Start/Stop” button was not pressed.	23
The bobbin winder shaft is pushed to the right.	12
There is no stitch selected.	23
Presser foot is not lowered.	24
“Start/Stop” button was pressed with the foot controller attached.	24
Needle breaks.	
Needle is installed incorrectly.	20
Needle clamp screw is not tightened.	20
Needle is turned or bent.	20
Using improper needle or thread for the selected fabric.	19
Wrong presser foot was used.	21
Upper thread tension is too tight.	27
Fabric is pulled during sewing.	–
Spool of thread is set incorrectly.	12
There are scratches around the opening in the needle plate. * There is a notch on the left side of the opening in the needle plate. This is not a scratch.	*
	
There are scratches around the opening in the presser foot.	*
There are scratches on the bobbin case.	*
A bobbin designed specifically for this machine is not used.	12
Upper threading is incorrect.	15

Symptom, Cause/solution	Reference
Bobbin is set incorrectly.	14
Presser foot is attached incorrectly.	21
Screw of the presser foot holder is loose.	22
Fabric is too thick.	19, 30
Fabric is fed forcefully when sewing thick fabric or thick seams.	30
Stitch length is too short.	27
Bobbin thread is incorrectly wound.	12
Upper thread breaks.	
Machine is not threaded correctly (used the wrong spool cap, spool cap is loose, the thread did not catch the needle bar threader, etc.).	15
Knotted or tangled thread is being used.	–
The selected needle is not appropriate for the thread being used.	19
Upper thread tension is too tight.	27
Thread is tangled.	57
Needle is turned, bent or the point is dull.	20
Needle is installed incorrectly.	20
There are scratches around the opening of the needle plate. * There is a notch on the left side of the opening in the needle plate. This is not a scratch.	*
	
There are scratches around the opening in the presser foot.	*
There are scratches on the bobbin case.	*
Using improper needle or thread for the selected fabric.	19
A bobbin designed specifically for this machine is not used.	12
The thread is tangled on the wrong side of the fabric.	
Upper threading is incorrect.	15, 58
Using improper needle or thread for the selected fabric.	19
The upper thread is too tight.	
The bobbin thread is incorrectly installed.	14, 57

Symptom, Cause/solution	Reference
Bobbin thread breaks.	
Bobbin is set incorrectly.	14
Bobbin thread is incorrectly wound.	12
A scratched bobbin is being used.	14
Thread is tangled.	59
A bobbin designed specifically for this machine is not used.	12
Fabric puckers.	
There is a mistake in the upper or bobbin threading.	12, 15
Spool of thread is set incorrectly.	12
Using improper needle or thread for the selected fabric.	19
Needle is turned, bent or the point is dull.	20
Stitches are too long when sewing thin fabrics.	27
Thread tension is set incorrectly.	27, 58
Wrong presser foot was used.	21
The stitch is not sewn correctly.	
The presser foot that is used is not appropriate for the type of stitch that you wish to sew.	21
The thread tension is incorrect.	27, 58
The thread is tangled, for example, in the bobbin case.	59
Feed dogs are set in the down position. <ul style="list-style-type: none"> Slide the feed dog position switch to the right (▲▲). 	5, 48
Skipped stitches	
Machine is threaded incorrectly.	12, 15
Using improper needle or thread for the selected fabric.	19
Needle is turned, bent or the point is dull.	20
Needle is installed incorrectly.	20
Dust or lint has collected under the needle plate.	55
Thin or stretch fabrics are being sewn. <ul style="list-style-type: none"> Sew with non-woven water soluble stabilizer under the fabric. 	30

Symptom, Cause/solution	Reference
Not stitching	
Needle is turned, bent or the point is dull.	20
Bobbin is set incorrectly.	14
Upper threading is incorrect.	15
High-pitched sound while sewing	
Dust or lint is caught in the feed dogs.	55
Pieces of thread are caught in the race.	55
Upper threading is incorrect.	15
A bobbin designed specifically for this machine is not used.	12
There are needle holes or friction scratches in the bobbin case.	*
Fabric does not feed through the machine.	
Feed dogs are set in the down position. <ul style="list-style-type: none"> Slide the feed dog position switch to the right (▲▲). 	5
Stitches are too close together.	27
Wrong presser foot was used.	21
Needle is turned, bent or the point is dull.	20
Thread is entangled.	59
Zigzag foot "J" is slanted on a thick seam at the beginning of stitching.	30
The fabric feeds in the opposite direction.	
The feed mechanism is damaged.	*
The needle contacts the needle plate.	
The needle clamp screw is loose.	20
Needle is turned, bent or the point is dull.	20
Fabric being sewn with the machine cannot be removed.	
Thread is tangled below the needle plate.	59

Symptom, Cause/solution	Reference
A broken needle has fallen into the machine.	
<ul style="list-style-type: none"> Turn off the machine, and remove the needle plate. If the needle that fell into the machine can be seen, use tweezers to remove it. After removing the needle, return the needle plate to its original position and insert a new needle. Before turning on the machine, slowly turn the handwheel toward you to check that it turns smoothly and that the new needle enters through the center of the needle plate opening. If the handwheel does not turn smoothly or the needle that fell into the machine cannot be removed, consult your authorized Brother dealer or the nearest Brother authorized service center. 	59
The handwheel does not turn smoothly.	
Thread is tangled in the bobbin case.	55, 57, 59





■ After sewing

Symptom, Cause/solution	Reference
Thread tension is incorrect.	
Upper threading is incorrect.	15, 58
Bobbin is set incorrectly.	14, 58
Using improper needle or thread for the selected fabric.	19
Presser foot holder is not attached correctly.	21
Thread tension is set incorrectly.	27, 58
Bobbin thread is incorrectly wound.	14
Needle is turned, bent or the point is dull.	20
A bobbin designed specifically for this machine is not used.	12
Decorative stitch patterns are misaligned.	
Wrong presser foot was used.	33
Stitch pattern adjustment settings were set incorrectly.	54
Stitch pattern is irregular.	
Wrong presser foot was used.	21
Thin or stretch fabrics are being sewn. <ul style="list-style-type: none"> Attach stabilizer material to the fabric. 	30
Thread tension is set incorrectly.	27, 58
Fabric was pulled, pushed or fed at an angle while it was being sewn. <ul style="list-style-type: none"> Sew while guiding the fabric with your hands so that the fabric is fed in a straight line. 	23

Symptom, Cause/solution	Reference
The thread is tangled, for example, in the bobbin case.	55

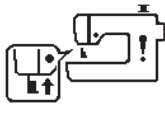
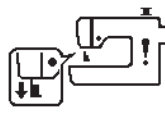
Error messages

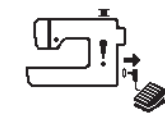
When erroneous operations are performed messages and advice on operation will be displayed on the LCD. Follow what is displayed. The error message will disappear if an operation button is pressed or the correct operation is performed while the error message is displayed.

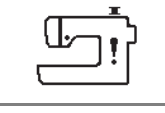
Error Messages		Cause	Solution
80/60/50 stitches models	16 stitches model		
E1		This message is displayed when a button, such as the "Start/Stop" button, is pressed (The foot controller was depressed if it is connected.) while the presser foot was raised.	Lower the presser foot lever before continuing the operation.
E2		This message is displayed when the buttonhole lever is down, a stitch other than a buttonhole is selected, presser foot is lowered and a button, such as the "Start/Stop" button, is pressed (The foot controller was depressed if it is connected.).	Raise the buttonhole lever before continuing the operation.
E3		This message is displayed when the buttonhole lever is up, a buttonhole stitch is selected, presser foot is lowered and a button, such as the "Start/Stop" button, is pressed (The foot controller was depressed if it is connected.).	Lower the buttonhole lever before continuing the operation.
E4		This message is displayed when a button, such as the Reverse stitch button, is pressed while the bobbin winder shaft is moved to the right.	Move the bobbin winder shaft to the left before continuing the operation.
E5		This message is displayed when the "Start/Stop" button is pressed while the foot controller is connected.	Disconnect the foot controller, and then press the "Start/Stop" button. Otherwise, operate the machine by using the foot controller.
E6		The motor locked up because the thread became tangled.	Clean the race to remove the tangled thread (page 55). After cleaning the race, insert the bobbin case properly. If the needle is bent or broken, replace the needle. Then, thread the upper and bobbin threads properly, and continue the operation.
E7	-	This message is displayed when the needle mode selection key is pressed while a stitch that cannot be used with the twin needle is selected.	Select a stitch that can be used with the twin needle.
E8	-	This message is displayed when  (Twin needle) is turned on, and a stitch pattern that cannot be sewn with the twin needle is selected.	Switch to the single needle mode, and replace the twin needle with a single needle before continuing the operation.
E9		This message is displayed when the needle plate cover is removed while the machine is still turned on.	Turn off the machine, and then attach the needle plate cover before continuing the operation.
F*	F*	If error message "F*" appears in the LCD while the machine is being used, the machine may be malfunctioning. ("F*" will be replaced with a number.)	Contact your nearest Brother authorized service center.

Operation beeps

If a correct operation is performed, the machine beeps one time.

If an incorrect operation is performed, the machine beeps two or four times.

If the machine locks up, for example, because the thread is tangled, the machine continues to beep for seven seconds, and then the machine automatically stops. Be sure to check for the cause of the error, and correct it before continuing to sew.

Index

A

Appliqué 45

B

Ball point needle 19
 Bar tack stitch 49
 Blind hem stitch 39
 Bobbin 12
 Bobbin case 56
 Bobbin installation 14
 Bobbin thread 12
 Bobbin winding 12
 Bobbin winding thread guide 12
 Button sewing 43
 Buttonhole 40

C

Cleaning 55
 Cylindrical pieces 29

D

Denim 19, 30

E

Elastic tape 49
 Error messages 65
 Even seam allowance 29

F

Fabric 19, 30
 Fagoting 50
 Feed dog position switch 5, 48
 Feed dogs 5
 Foot controller 24
 Free motion quilting 48

H

Heirloom stitching 53

I

Included accessories 7

J

Joining 51

L

LCD 6, 10
 Leather 31

M

Maintenance 55
 Metallic thread 12, 17

N

Needle 19, 20
 Needle plate 5, 59
 Needle plate cover 5, 55
 Needle position 10, 11, 29

Needle threader 17

O

Operation beep 11, 65
 Optional accessories 8
 Overcasting stitches 38

P

Patchwork 46
 Piecing 46
 Power supply 9
 Presser foot 10, 21, 24, 33
 Presser foot holder 5
 Pulling up bobbin thread 18

Q

Quilting 47
 Quilting guide 47

R

Race 56
 Reinforcement priority 27
 Reinforcement stitch 25, 33
 Reverse stitch 25, 33

S

Scallop stitching 50
 Sewing speed controller 6
 Shell tuck stitch 51
 Smocking 50
 Speed 13, 24
 Spool cap 12
 Spool net 12
 Stitch length 27
 Stitch width 27
 Straight stitch 29, 33, 46
 Stretch fabrics 31

T

Thick fabrics 30
 Thin fabrics 30
 Thread 19
 Thread tension 27, 58
 Transparent nylon thread 12, 13, 17, 19, 34
 Troubleshooting 57
 Twin needle 52

U

Upper thread 15, 19

V

Vinyl fabrics 31

W

Walking foot 47
 Wing needle 53

Z

Zigzag stitch 27
 Zipper 44





Please visit us at <http://s.brother/cpjah/> where you can get the support information (Instruction Videos, FAQs, etc.) for your Brother product.



To get information about Winding/Installing the Bobbin, please go to <http://s.brother/cvjac/>.



To get information about Upper threading, please go to <http://s.brother/cvjad/>.



To get information about troubleshooting, please go to <http://s.brother/cfjah/>.



Brother SupportCenter is a mobile app that provides the support information (Instruction Videos, FAQs, etc.) for your Brother product. Visit the App Store or Google Play™ to download.

