



View this machine and more at:

<https://www.thesewingstudio.co.uk>

# 1

## 4-thread overlock

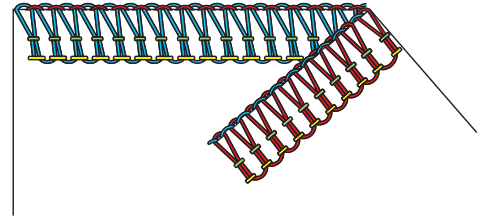

Threading / thread tension setting					Machine Setup				
Left needle	Right needle	Upper looper	Lower looper		Rolled hem lever	Upper looper converter	Cutting width	Stitch length	Differential feed
4	4	4	4		▲	-	6	2.5	1

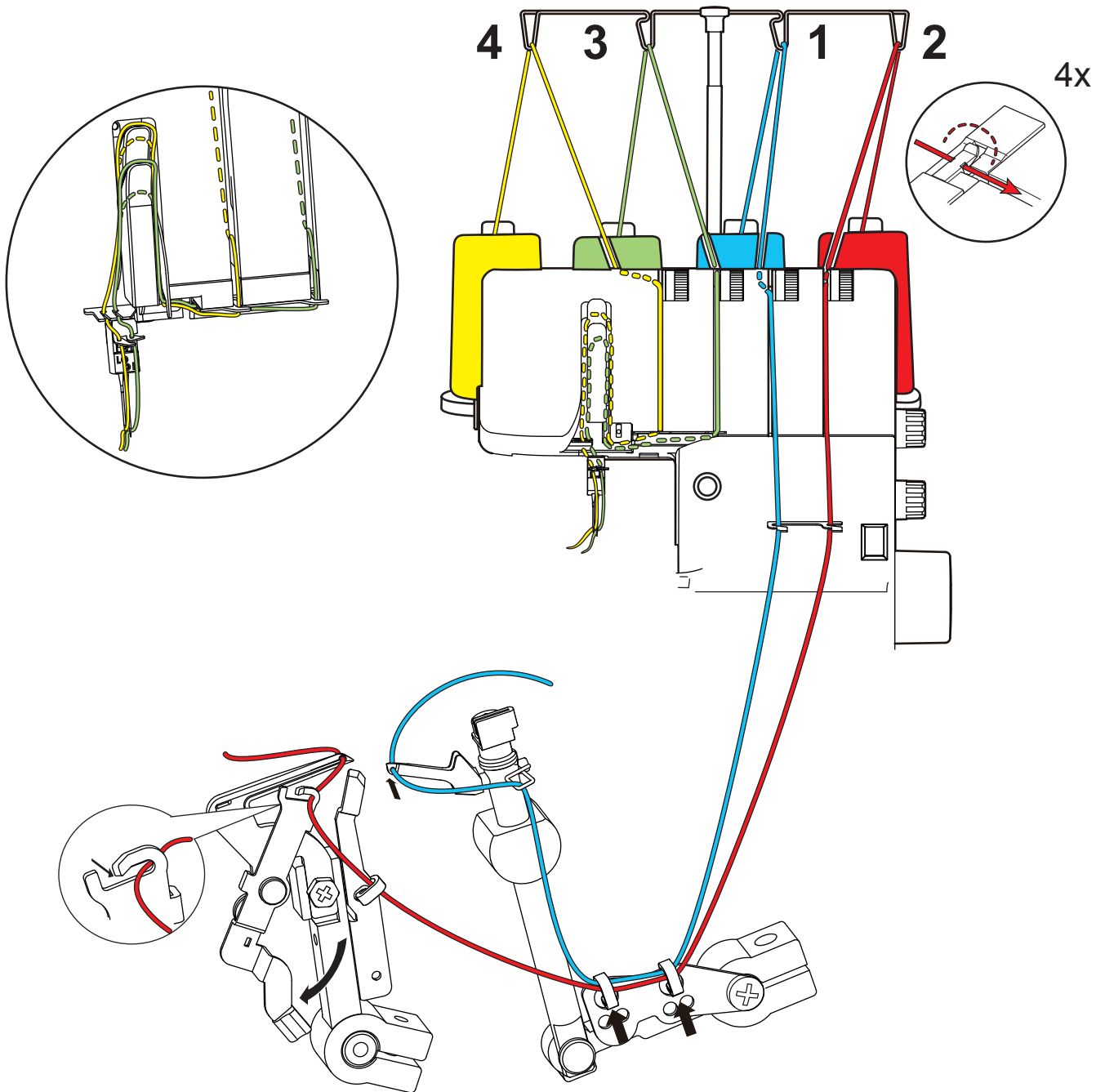

# 2

## 3-thread super stretch

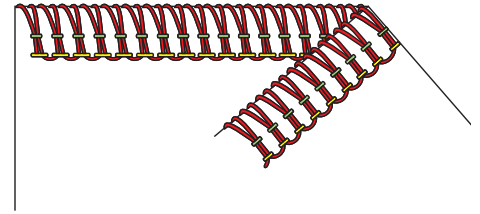

Threading / thread tension setting					Machine Setup				
Left needle	Right needle	Upper looper	Lower looper	Rolled hem lever	Upper looper converter	Cutting width	Stitch length	Differential feed	
4.5	4	-	3	▲		6	2.5	1	

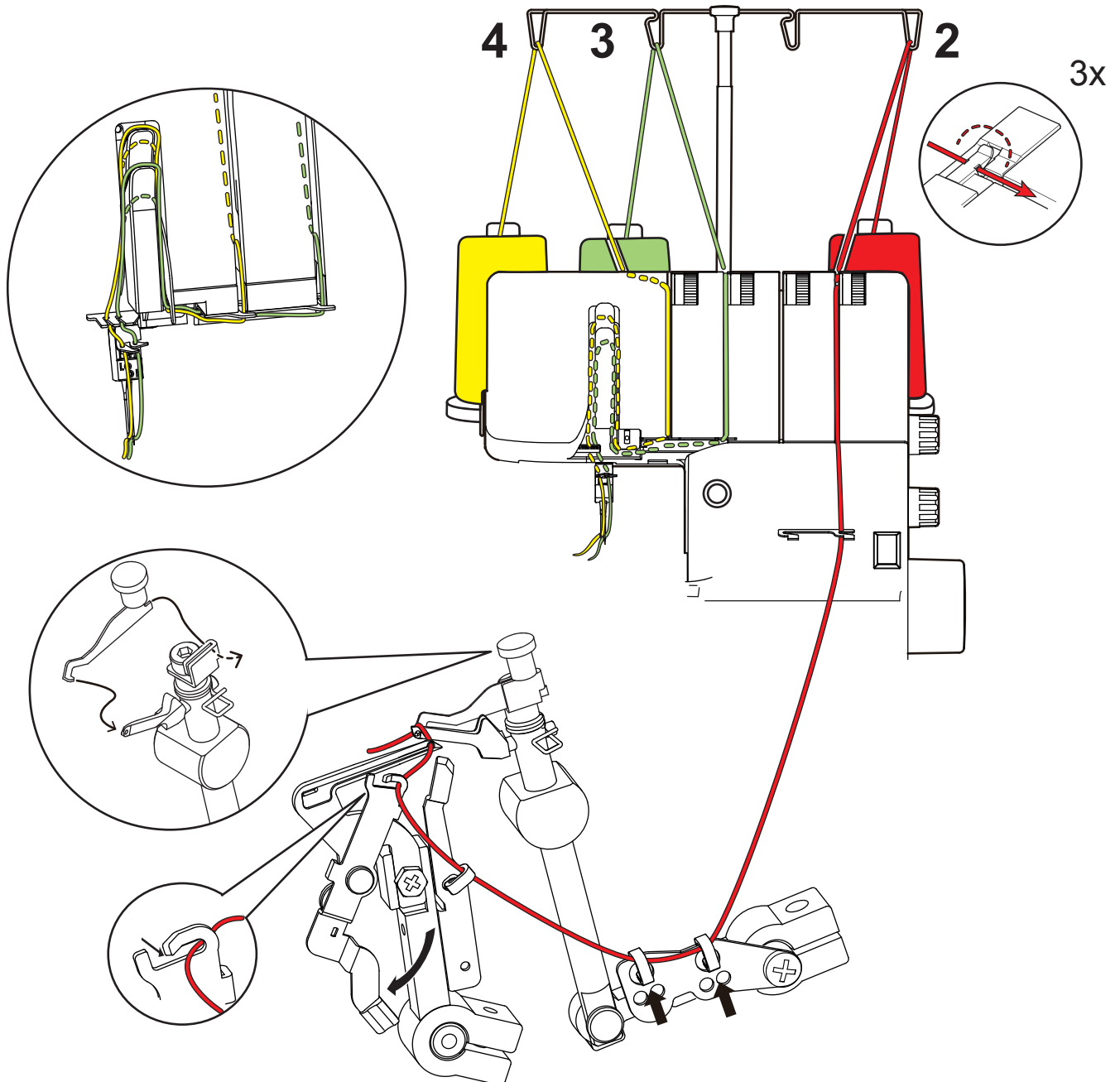

# 3

## 3-thread overlock (LN) (Left needle)

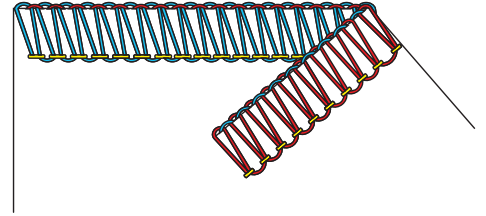

Threading / thread tension setting				Machine Setup					
Left needle	Right needle	Upper looper	Lower looper	Rolled hem lever	Upper looper converter	Cutting width	Stitch length	Differential feed	
4	-	4	4	▲	-	6	2.5	1	

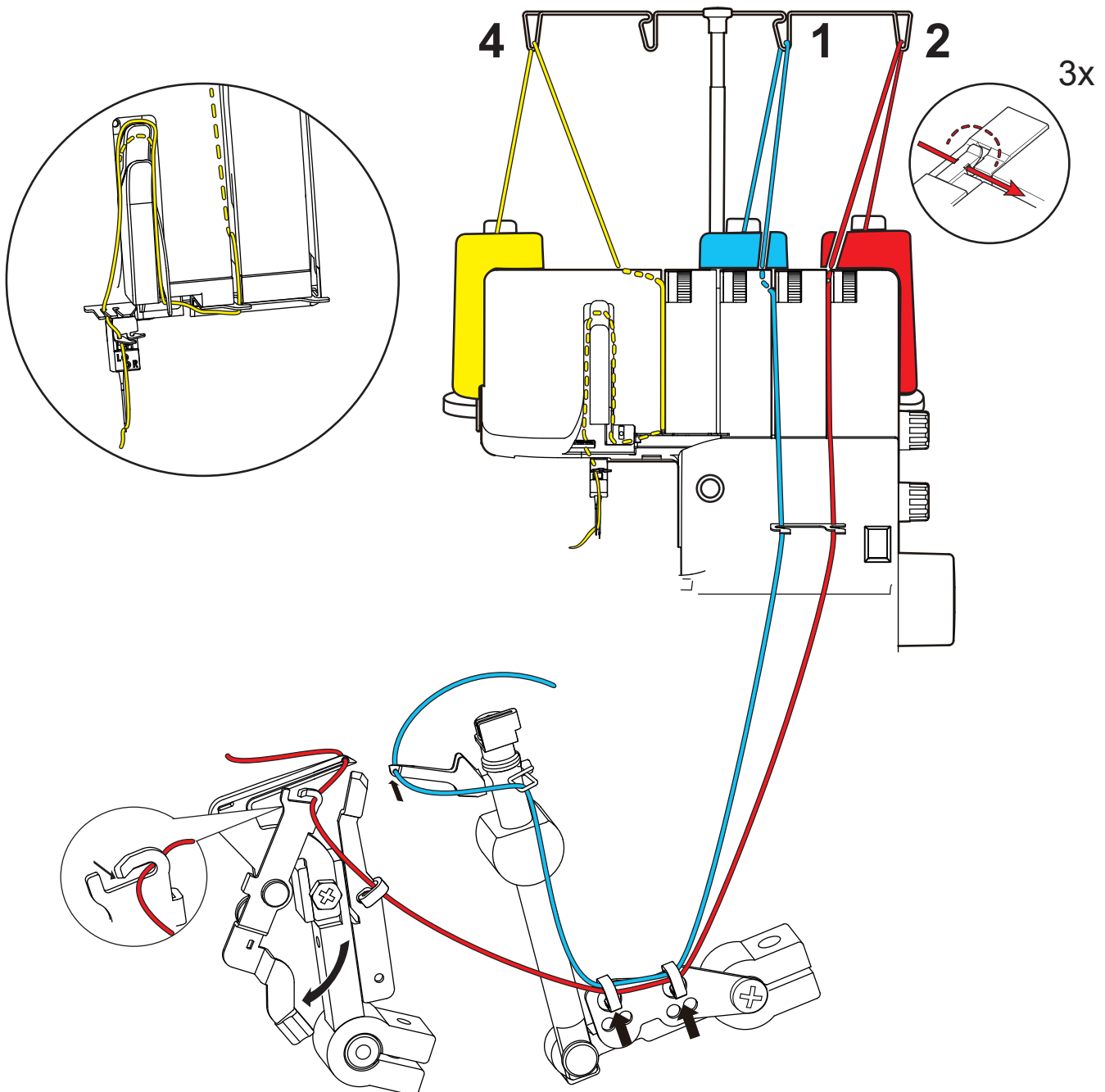



# 4

## 3-thread overlock (RN) (Right needle)

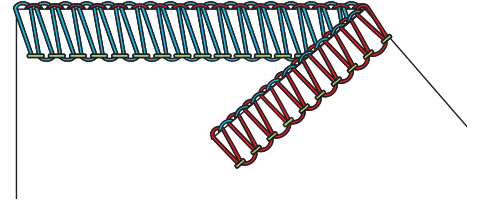

Threading / thread tension setting					Machine Setup				
Left needle	Right needle	Upper looper	Lower looper		Rolled hem lever	Upper looper converter	Cutting width	Stitch length	Differential feed
-	3.5	4	4		▲	-	6	2.5	1

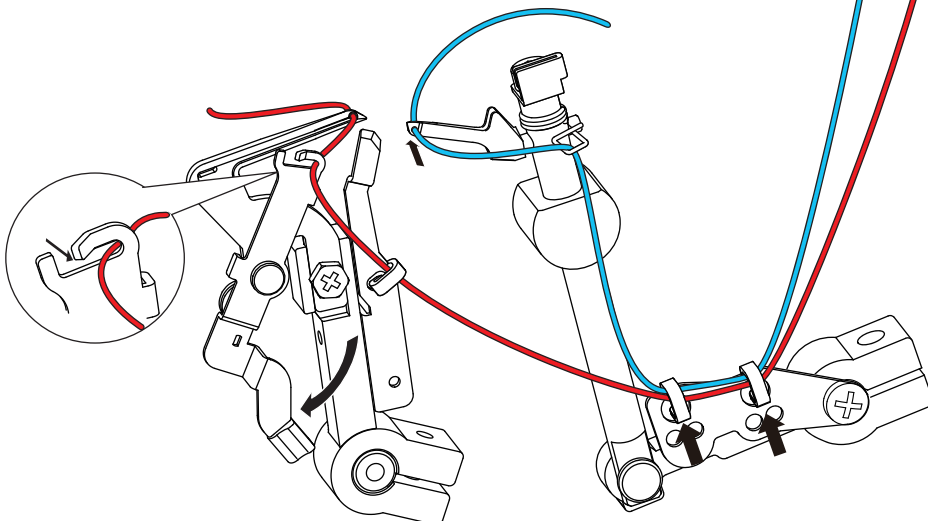
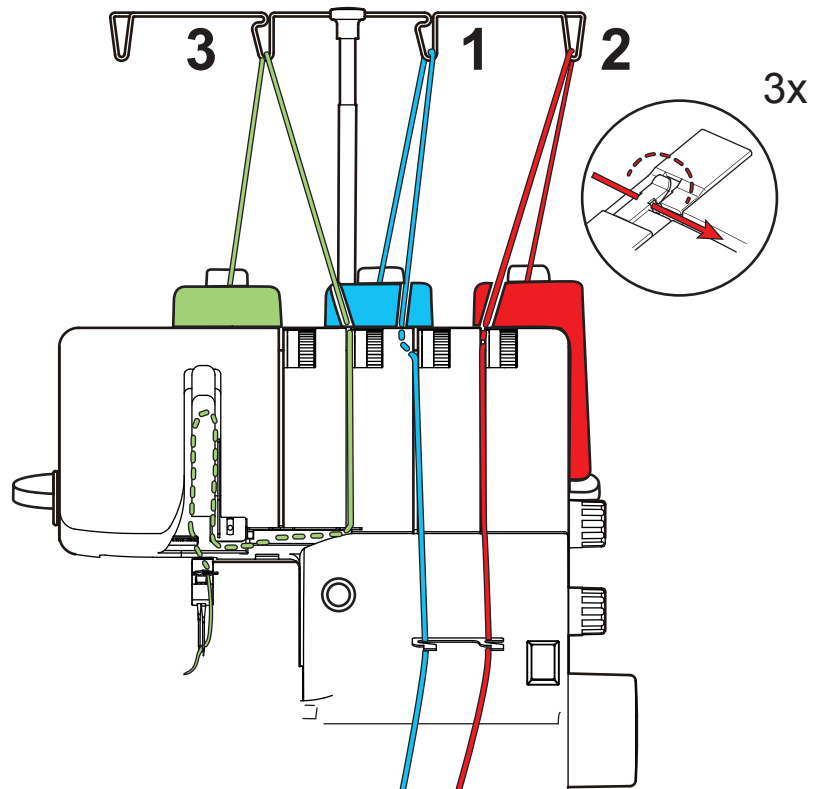
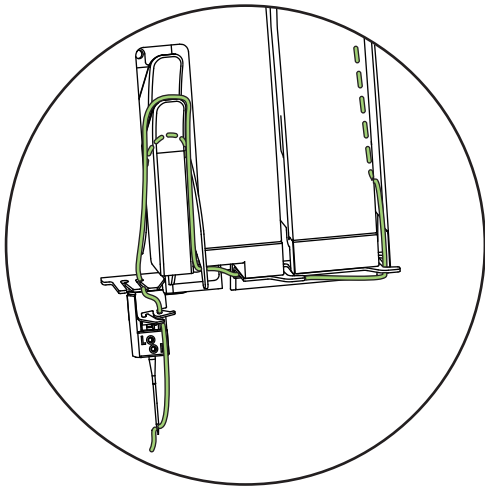

# 5

## 3-thread flatlock (LN) (Left needle)

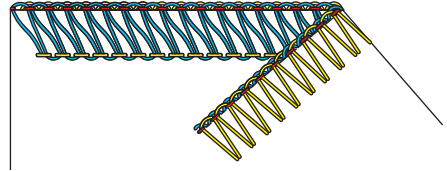

Threading / thread tension setting				Machine Setup					
Left needle	Right needle	Upper looper	Lower looper	Rolled hem lever	Upper looper converter	Cutting width	Stitch length	Differential feed	
1.5	-	3.5	7	▲	-	6.5	2.5	1	

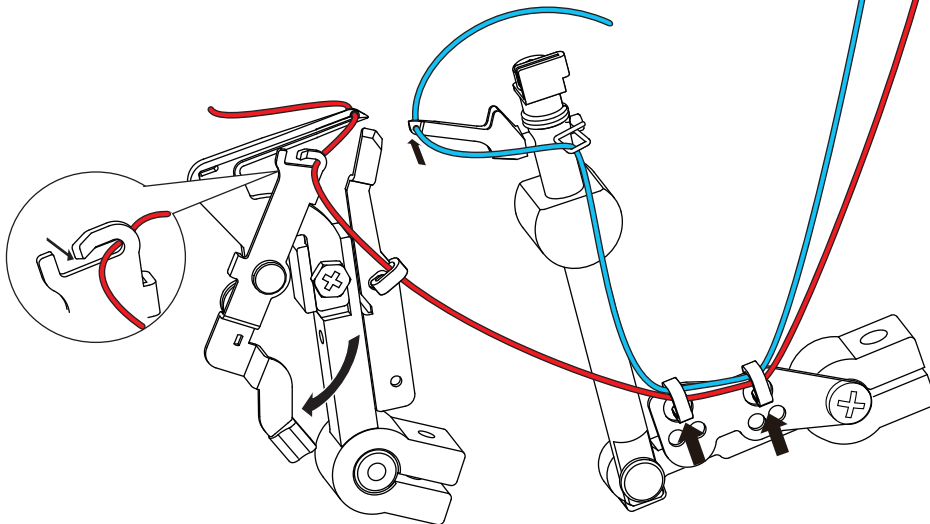
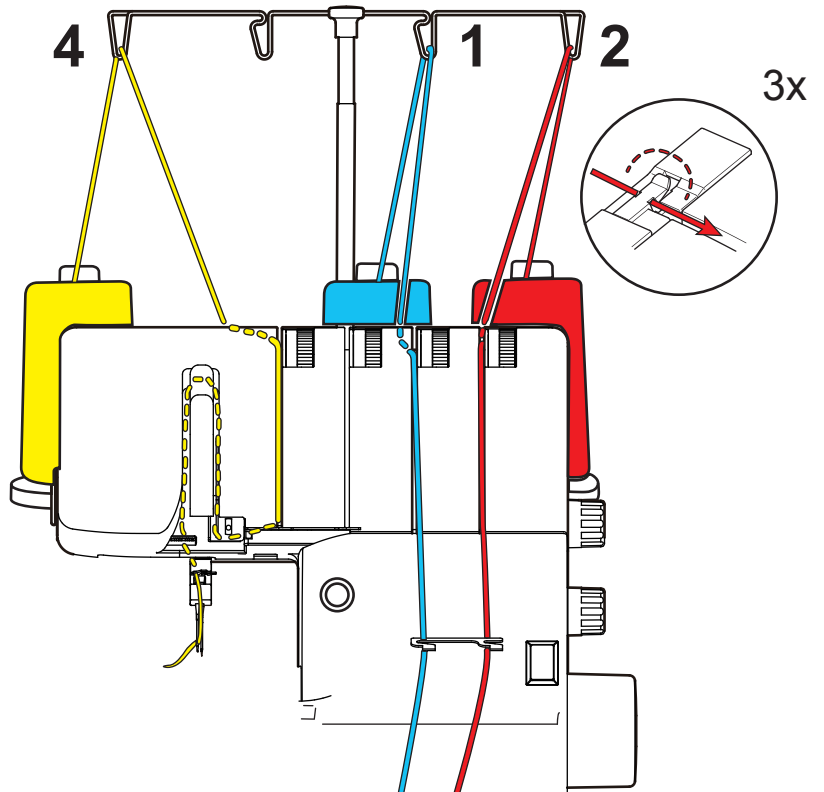
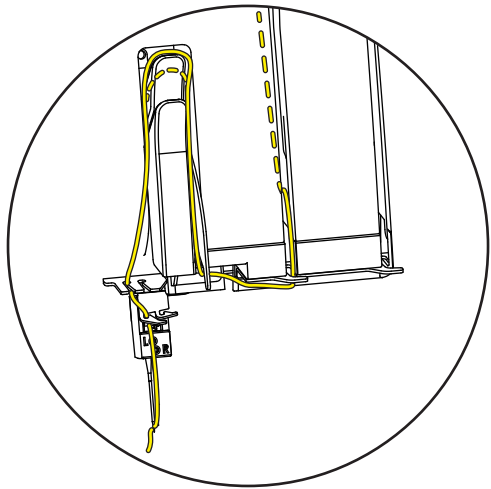

# 6

## 3-thread flatlock (RN) (Right needle)

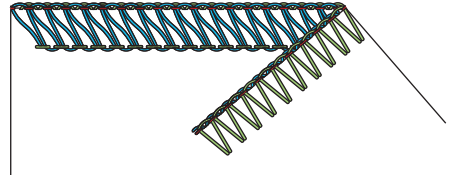

Threading / thread tension setting					Machine Setup				
Left needle	Right needle	Upper looper	Lower looper	Rolled hem lever	Upper looper converter	Cutting width	Stitch length	Differential feed	
-	2.5	4	7	▲	-	7	2.5	1	

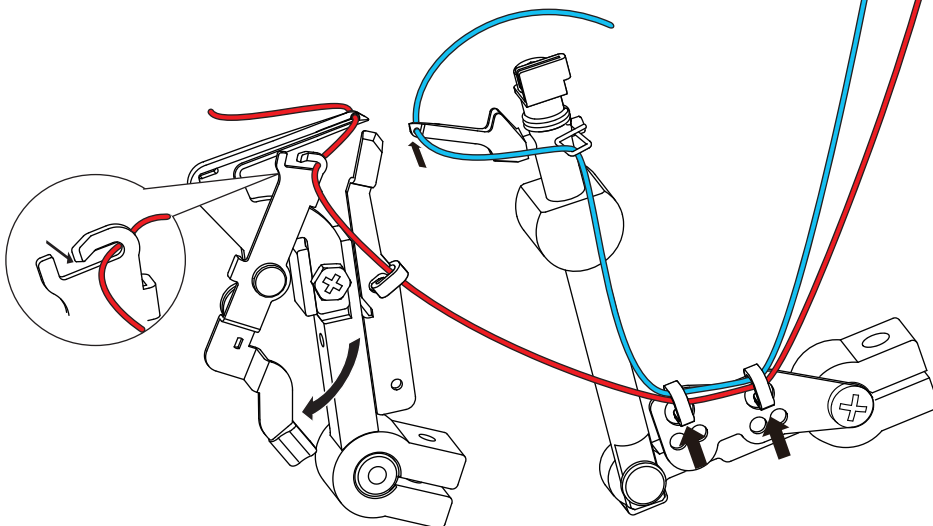
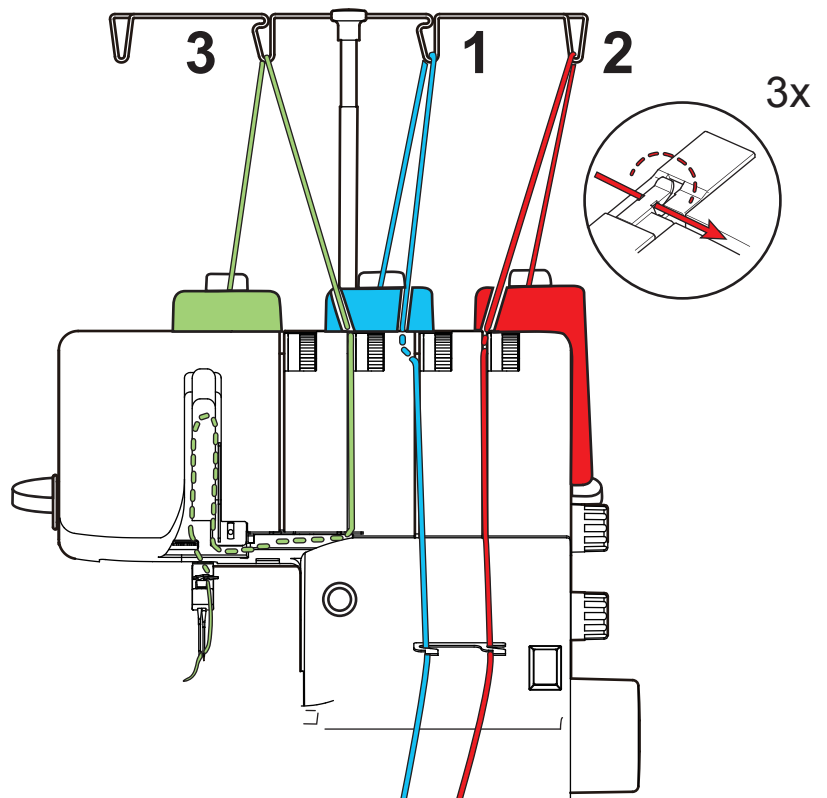
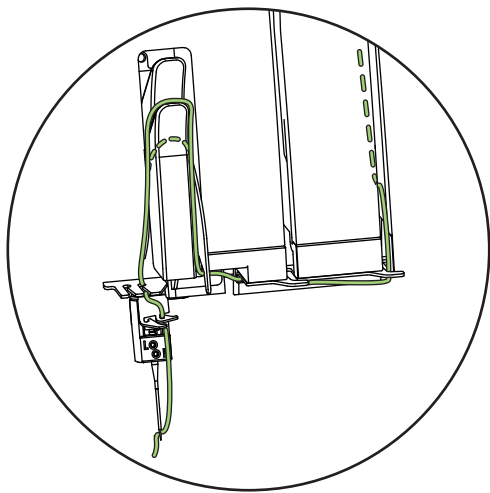

# 7

## 3-thread narrow seam

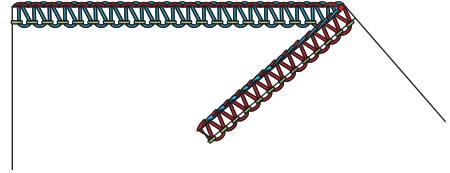

Threading / thread tension setting					Machine Setup				
Left needle	Right needle	Upper looper	Lower looper	Rolled hem lever	Upper looper converter	Cutting width	Stitch length	Differential feed	
-	4	4	4.5	▽	-	7	2	1	

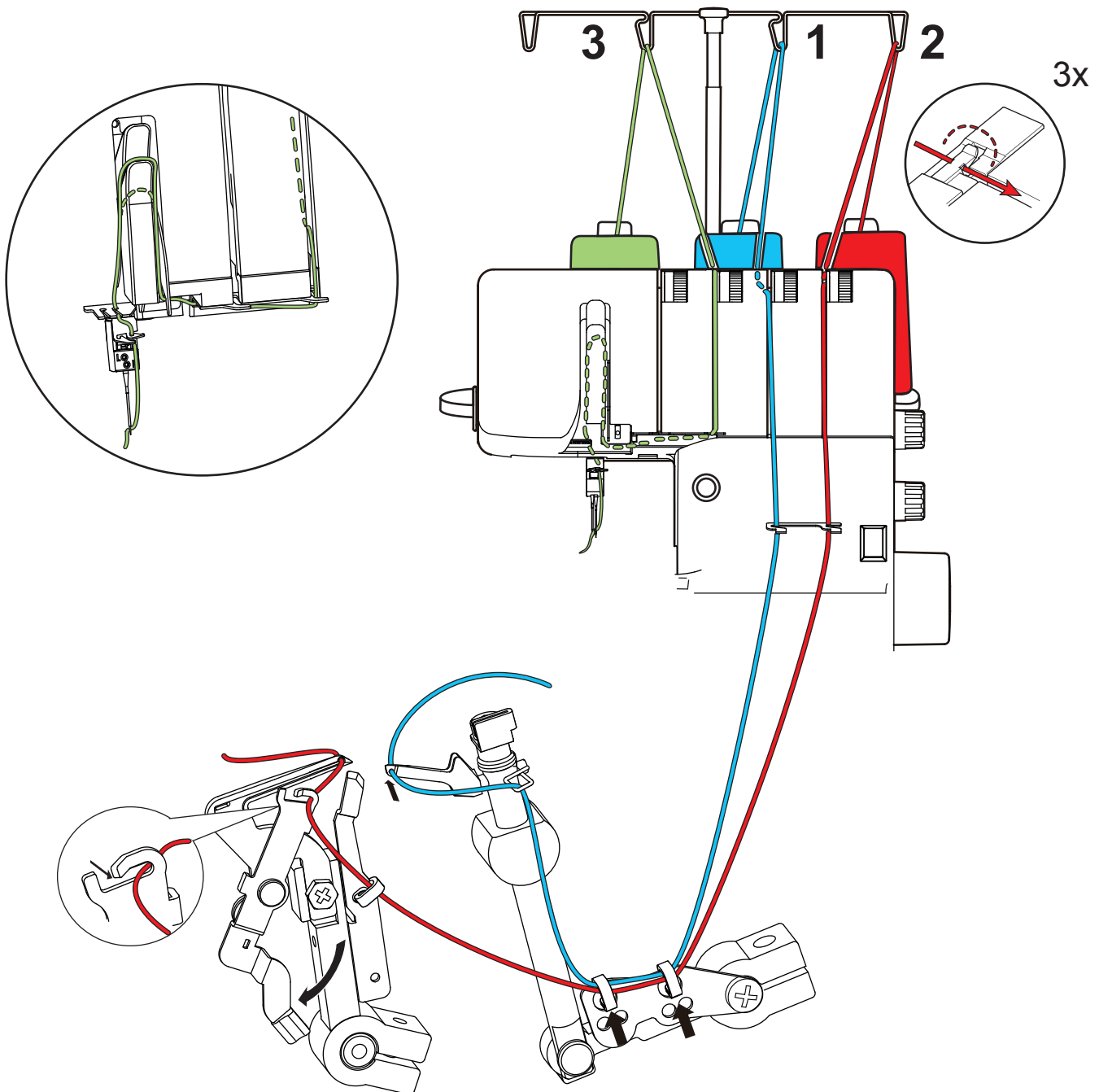

# 8

## 3-thread rolled hem

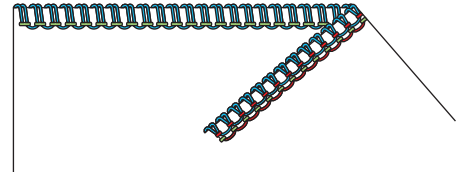

Threading / thread tension setting					Machine Setup				
Left needle	Right needle	Upper looper	Lower looper	Rolled hem lever	Upper looper converter	Cutting width	Stitch length	Differential feed	
-	3.5	4	7.5	▽	-	5	1	1	

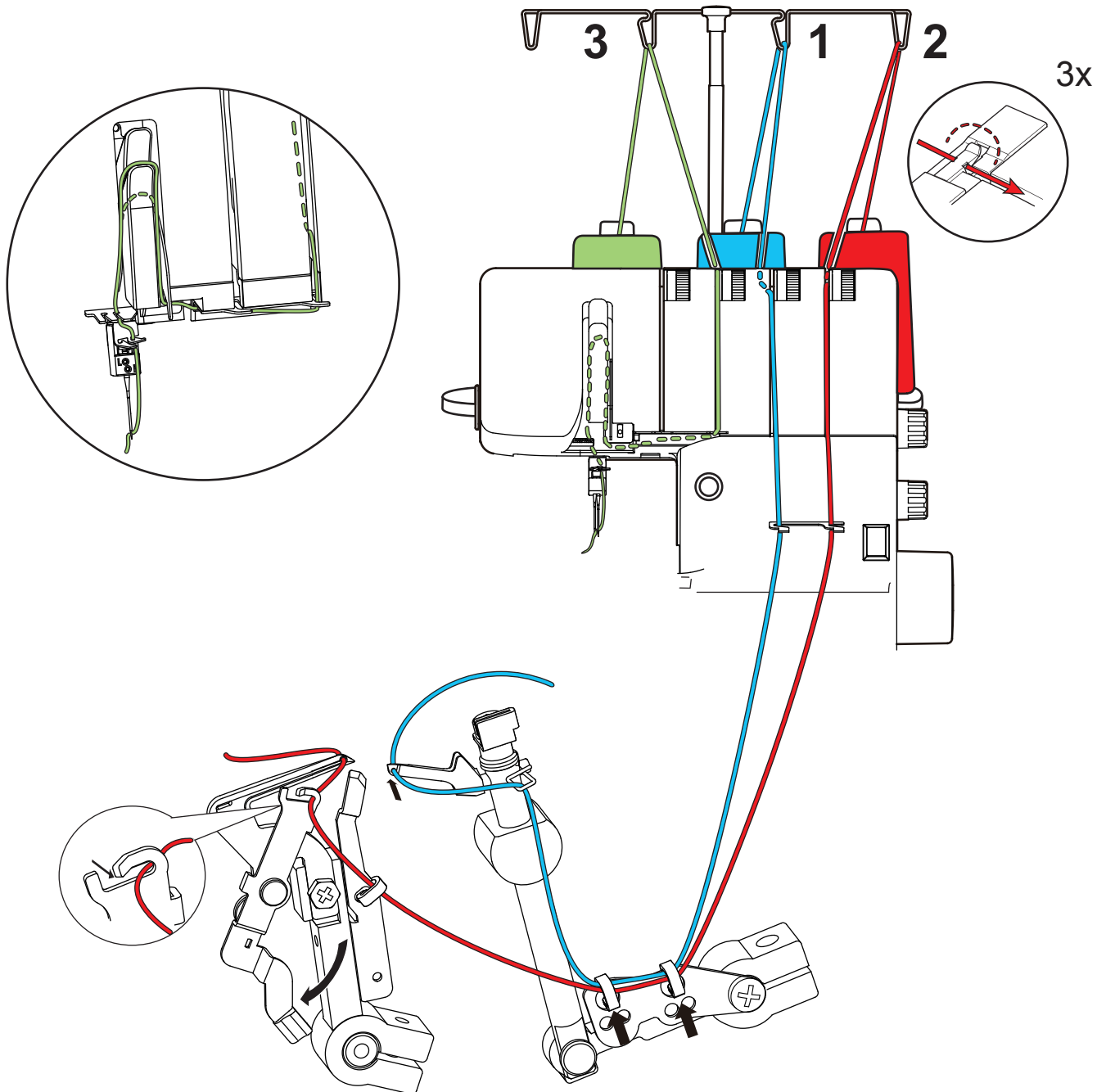

# 9

## 2-thread overlock (LN) (wrapped overlock left needle)

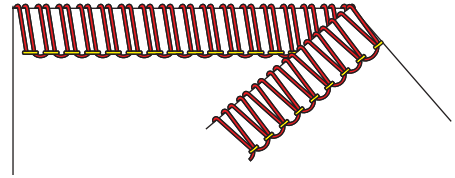

Threading / thread tension setting					Machine Setup				
Left needle	Right needle	Upper looper	Lower looper	Rolled hem lever	Upper looper converter	Cutting width	Stitch length	Differential feed	
5	-	-	3	▲		6	2.5	1	

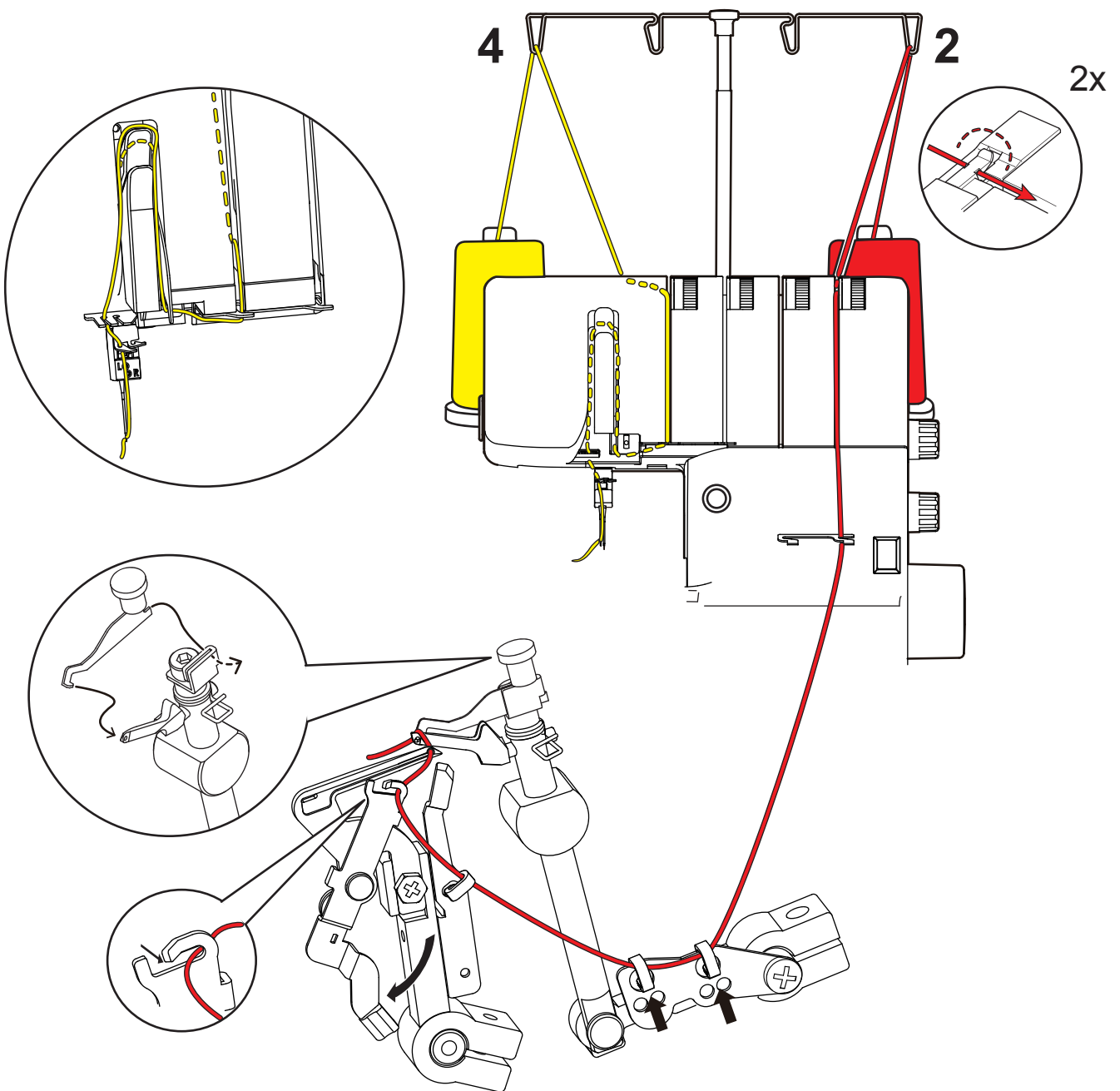

# 10

## 2-thread overlock (RN) (wrapped overlock right needle)

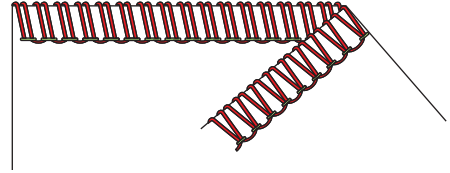

Threading / thread tension setting				Machine Setup					
Left needle	Right needle	Upper looper	Lower looper	Rolled hem lever	Upper looper converter	Cutting width	Stitch length	Differential feed	
-	6.5	-	3.5	▲		6	2.5	1	

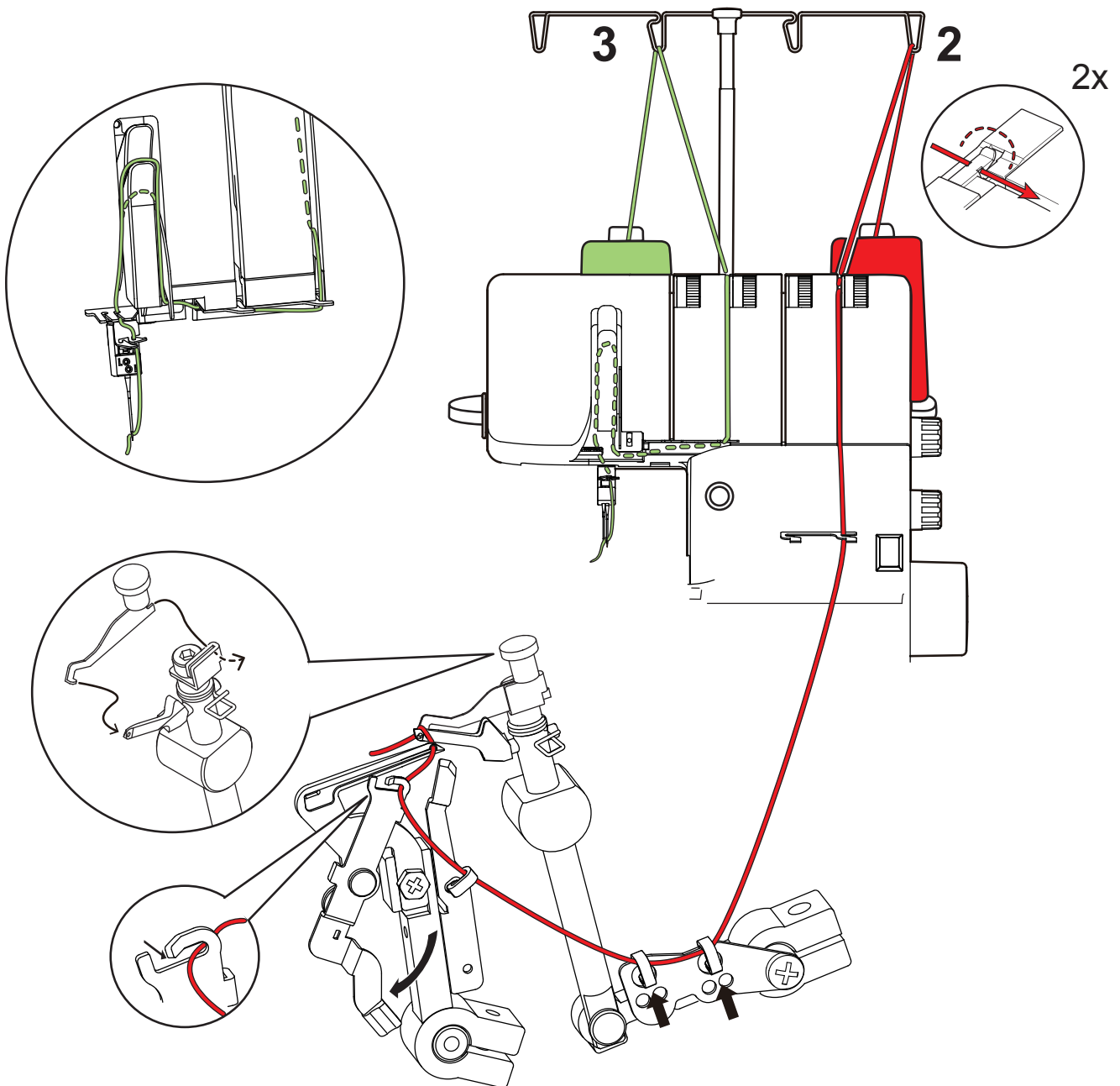



## 2-thread flatlock (LN) (Left needle)

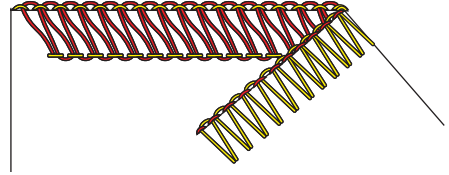

Threading / thread tension setting					Machine Setup				
Left needle	Right needle	Upper looper	Lower looper	Rolled hem lever	Upper looper converter	Cutting width	Stitch length	Differential feed	
2	-	-	4	▲		6.5	2.5	1	

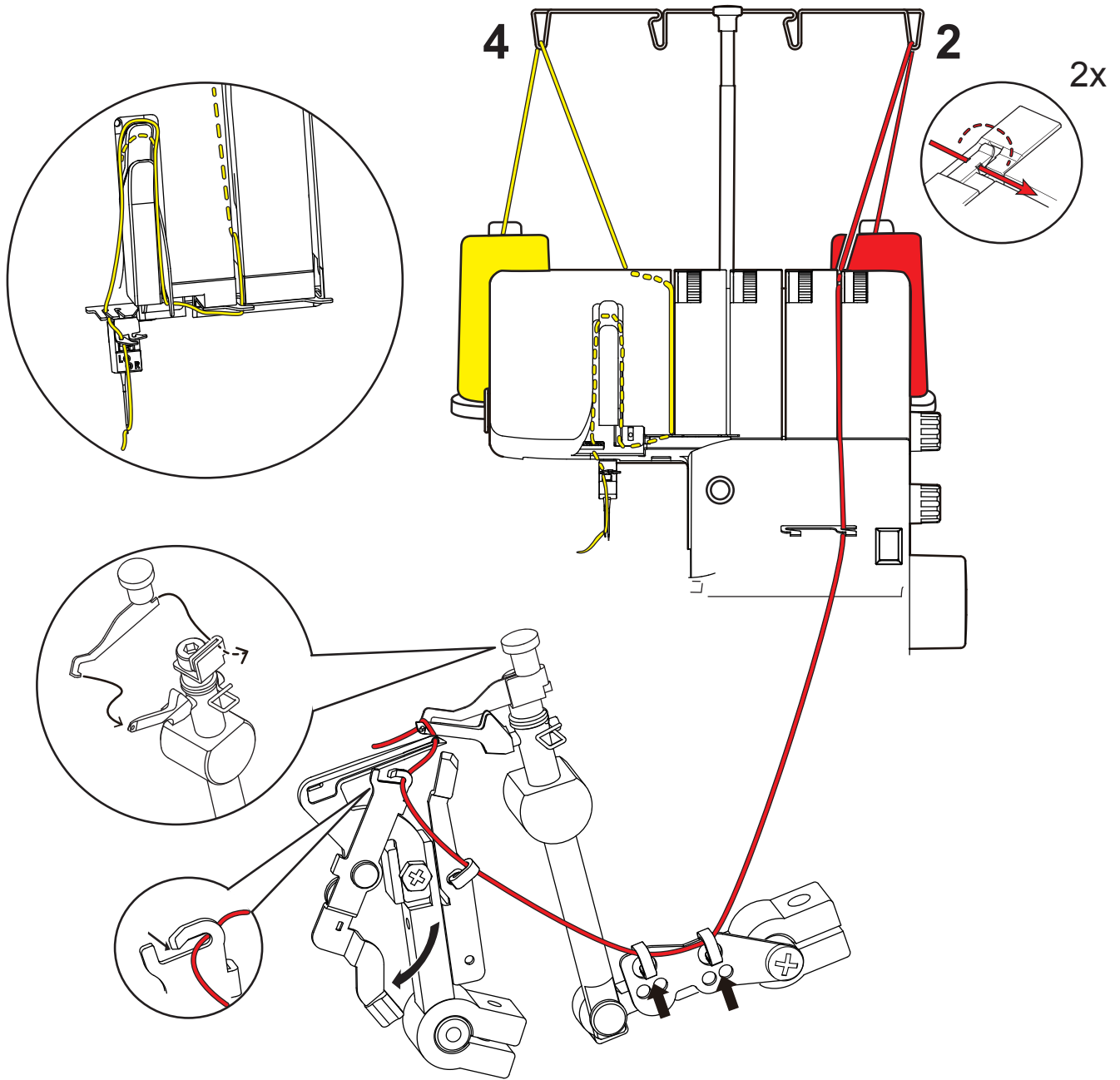



# 12

## 2-thread flatlock (RN) (Right needle)

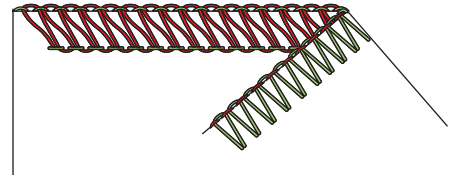

Threading / thread tension setting				Machine Setup					
Left needle	Right needle	Upper looper	Lower looper	Rolled hem lever	Upper looper converter	Cutting width	Stitch length	Differential feed	
-	2	-	4	▲		6	2.5	1	

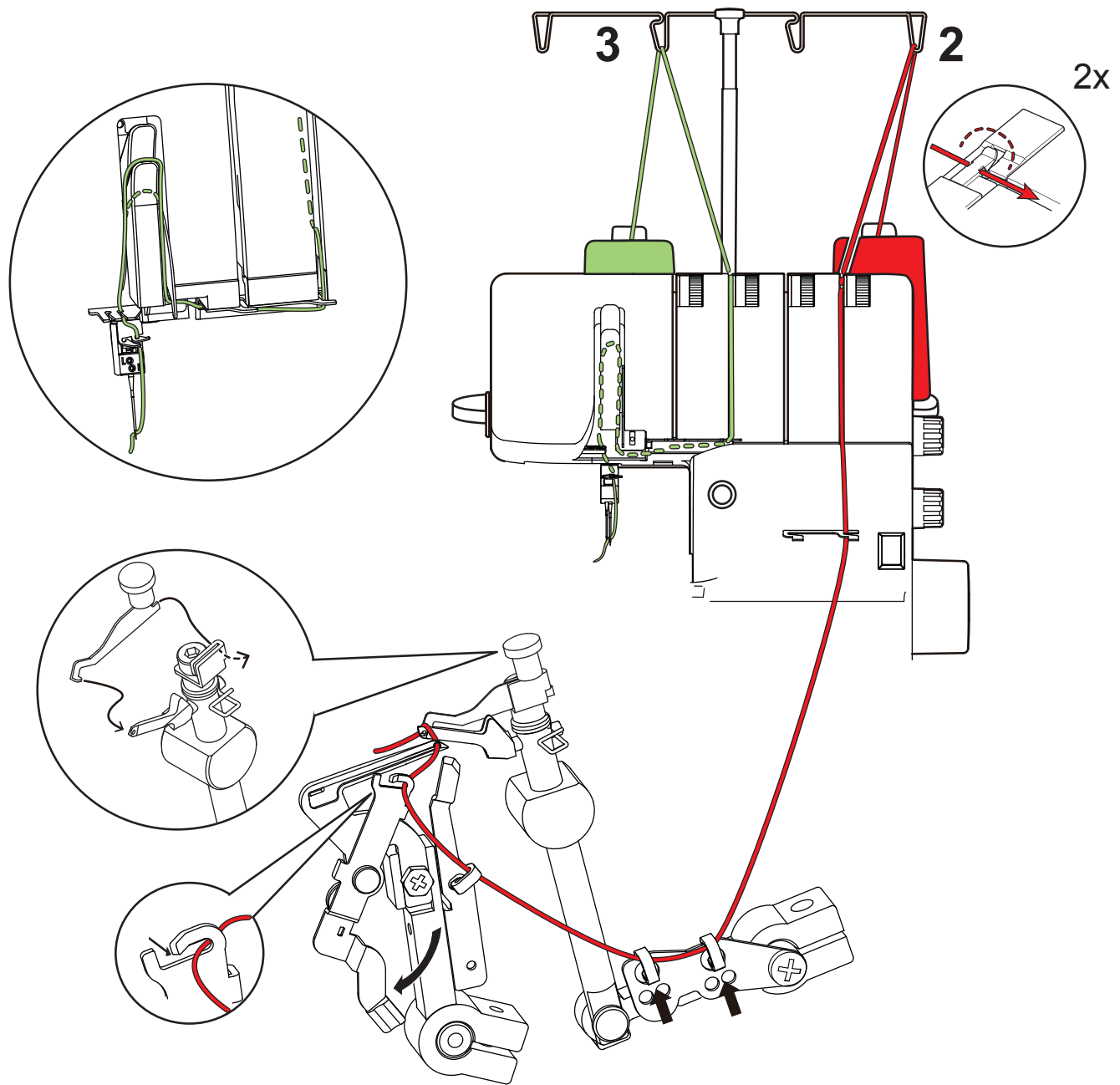

# 13

## 2-thread rolled hem

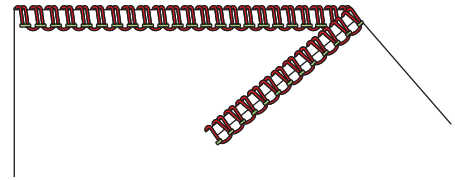

Threading / thread tension setting					Machine Setup				
Left needle	Right needle	Upper looper	Lower looper	Rolled hem lever	Upper looper converter	Cutting width	Stitch length	Differential feed	
-	4	-	4	▽		5	1	1	

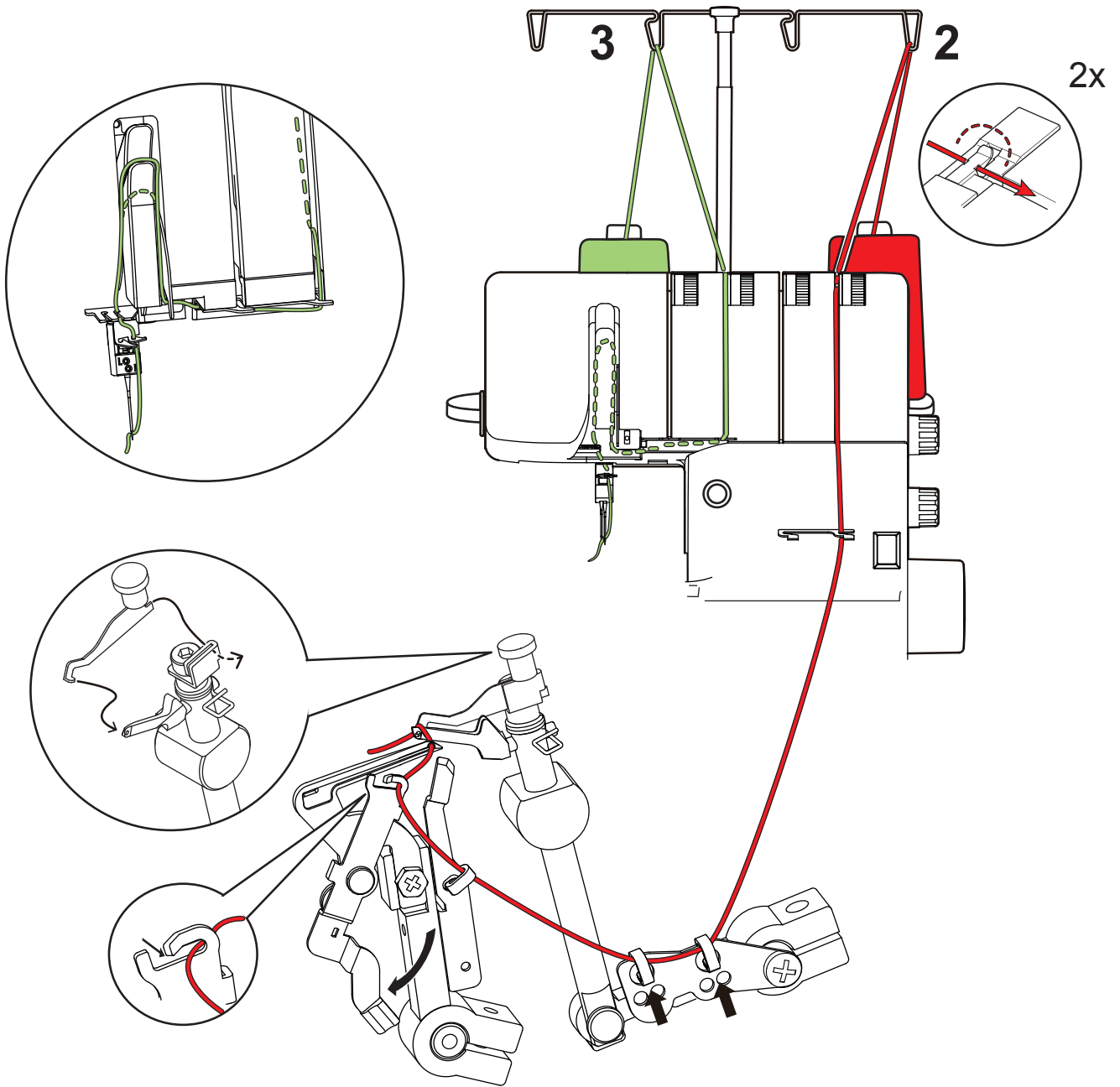

## 2-thread overlock (LN) (Left needle)

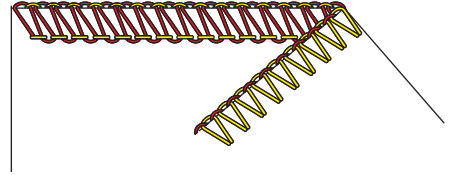

Threading / thread tension setting				Machine Setup					
Left needle	Right needle	Upper looper	Lower looper	Rolled hem lever	Upper looper converter	Cutting width	Stitch length	Differential feed	
2	-	-	4	▲		6	2.5	1	

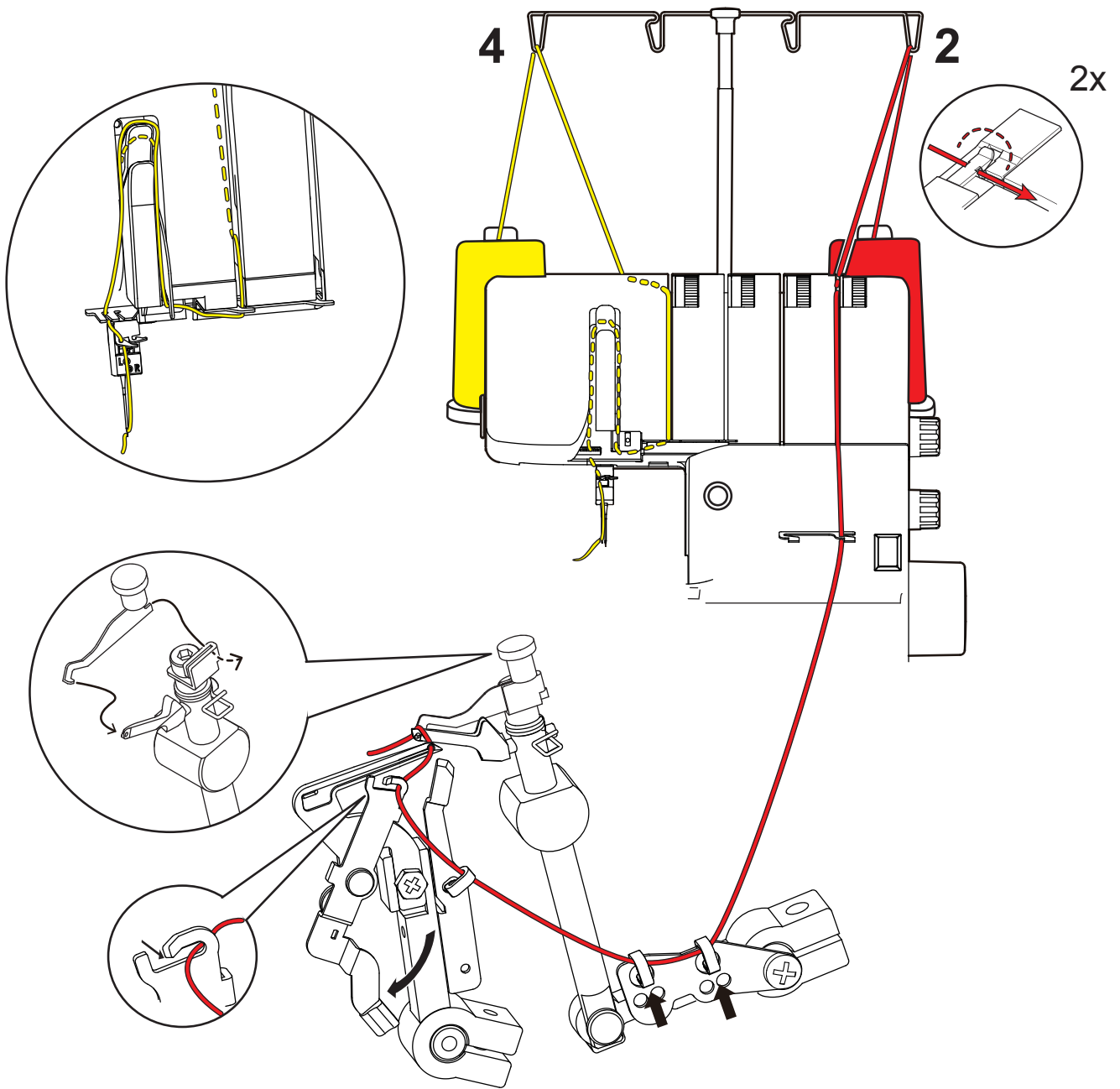

## 2-thread overlock (RN) (Right needle)

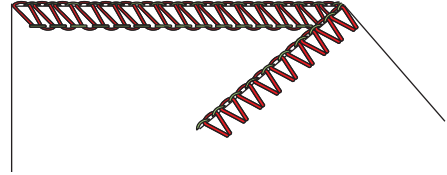

Threading / thread tension setting					Machine Setup				
Left needle	Right needle	Upper looper	Lower looper	Rolled hem lever	Upper looper converter	Cutting width	Stitch length	Differential feed	
-	2	-	4.5	▲		6	2.5	1	

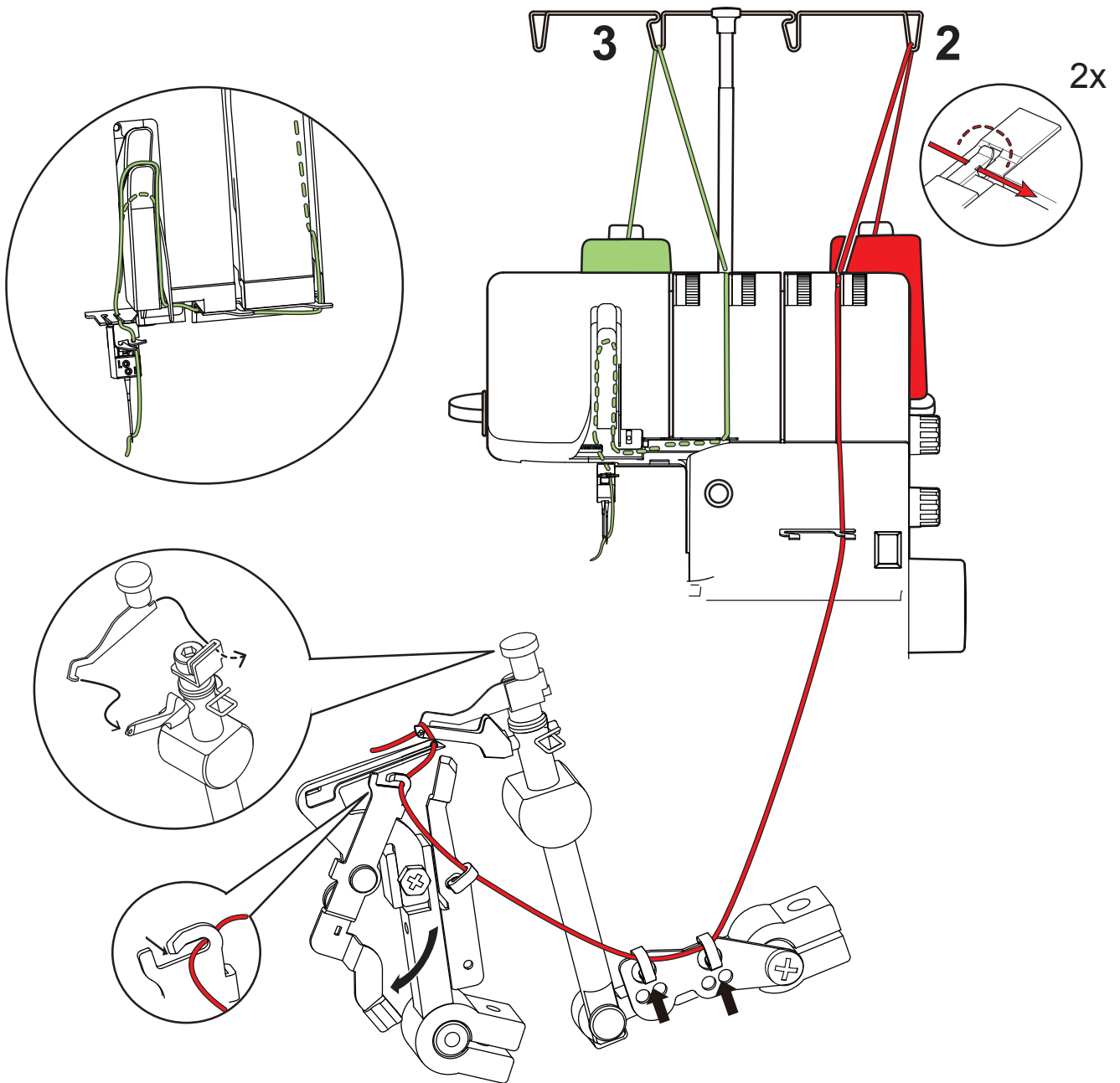

## 3-thread picot stitch

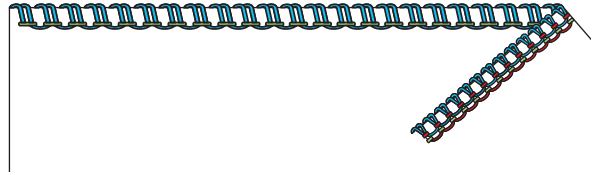

Threading / thread tension setting					Machine Setup				
Left needle	Right needle	Upper looper	Lower looper	Rolled hem lever	Upper looper converter	Cutting width	Stitch length	Differential feed	
-	3.5	3.5	6.5	▽	-	6	2.5	1	

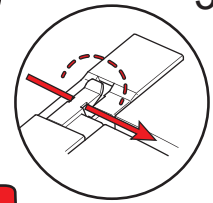
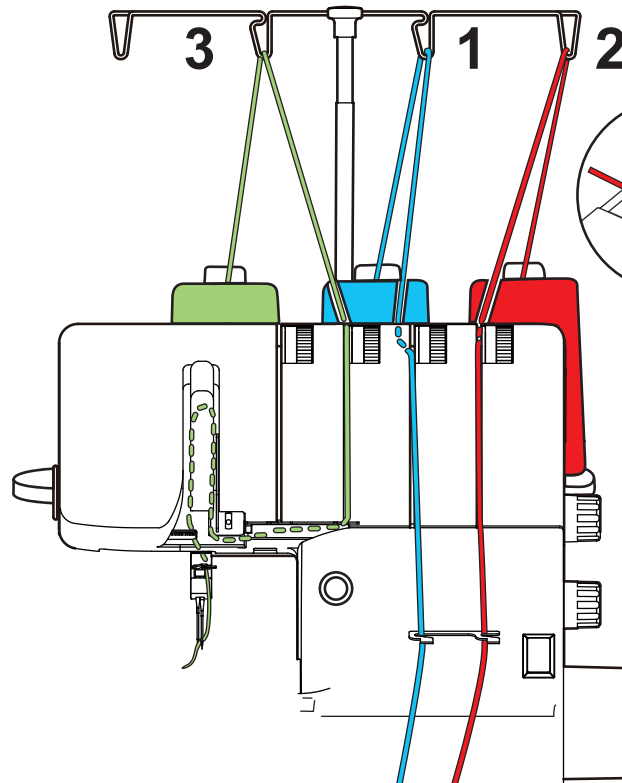
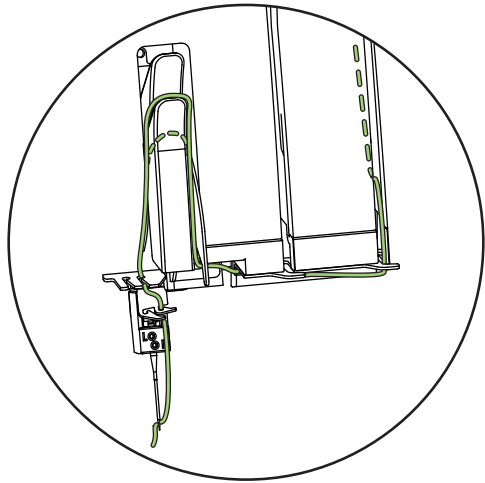

3x

