



View this machine and more at:

<https://www.thesewingstudio.co.uk>

KAFFE

BERNINA 570 QE  
KAFFE EDITION



made to create **BERNINA**



# Table of Contents

<b>IMPORTANT SAFETY INSTRUCTIONS .....</b>	<b>7</b>	2.5 Spool Pin .....	33
<b>Important Information .....</b>	<b>10</b>	Retractable Spool Pin .....	33
<b>1 My BERNINA .....</b>	<b>12</b>	Horizontal Spool Pin .....	34
1.1 Introduction .....	12	2.6 Feed Dog .....	35
1.2 BERNINA Quality Control .....	12	Adjusting the Feed Dog .....	35
1.3 Welcome to the World of BERNINA .....	12	2.7 Slide-on Table .....	35
1.4 Overview Machine .....	14	Using the Slide-on Table .....	35
Overview Front Controls .....	14	Using the Seam Guide .....	36
Overview - Front .....	15	2.8 Presser Foot .....	36
Overview - Side Panel .....	16	Adjusting the Presser Foot Position via the Knee Lifter of the Free Hand System .....	36
Overview - Back Panel .....	17	Adjusting the Presser Foot Position via the Button «Presser Foot Up/Down» .....	37
1.5 Supplied Accessories .....	18	Changing the Presser Foot .....	37
Overview Accessories Machine .....	18	Selecting the Presser Foot in the User Interface .....	37
Overview Presser Feet .....	20	Setting the Presser Foot Pressure .....	38
Accessories Box .....	21	2.9 Adjusting the Feed Dog .....	38
1.6 Overview User Interface .....	22	2.10 Needle and Stitch Plate .....	38
Overview Functions/Visual Information .....	22	Changing the Needle .....	38
Overview System Settings .....	22	Selecting the Needle in the User Interface .....	39
Overview Selection Menu Sewing .....	23	Selecting the Needle Type and the Needle Size .....	39
Software Operation .....	23	Adjusting the Needle Position Up/Down .....	39
1.7 Needle, Thread, Fabric .....	25	Adjusting the Needle Position Left/Right .....	39
Overview Needles .....	25	Needle Stop Up/Down (permanent) .....	40
Example for Needle Description .....	28	Changing the Stitch Plate .....	40
Thread Selection .....	28	Selecting the Stitch Plate in the User Interface .....	41
Needle/Thread Combination .....	29	2.11 Threading .....	41
<b>2 Sewing Preparation .....</b>	<b>30</b>	Threading the Upper Thread .....	41
2.1 Before Using the Machine for the First Time .....	30	Threading the Twin Needle .....	44
2.2 Accessories Box .....	30	Threading the Triple Needle .....	44
Removing and Mounting the Accessory Box from Machine .....	30	Winding the Bobbin Thread .....	45
Storing Accessory .....	30	Threading the Bobbin Thread .....	46
2.3 Connection and Switching On .....	31	Indicating Fill Level of Bobbin Thread .....	48
Connecting the Foot Control .....	31	<b>3 Setup Program .....</b>	<b>49</b>
Connecting the Machine .....	31	3.1 Sewing Settings .....	49
Attaching the Knee Lifter of the Free Hand System .....	32	Adjusting the Upper Thread Tension .....	49
Fixing the Touch Screen Pen .....	32	Adjusting the Maximum Sewing Speed .....	49
Switching the Machine On .....	32	Setting Securing Stitches (Smart Secure) .....	49
2.4 Foot Control .....	33	Adjusting the Hovering Height of the Presser Foot .....	50
Regulating the Speed via the Foot Control .....	33	Programming the Button «Pattern End» .....	50
Activate/Deactivate Additional Function .....	33	Programming the Button «Thread Cutter» .....	51
		Adjusting the Presser Foot Position with Needle Stop Down .....	52
		Programming the Button «Quick Reverse» .....	52



Programming the Foot Control .....	53	Programming Pattern Repeat .....	69
3.2 Embroidery Settings .....	53	Mirror Image of Stitch Patterns .....	69
Adjusting the Upper Thread Tension .....	53	Edit Stitch Pattern Length .....	69
Adjusting the Maximum Embroidering Speed .....	54	Programming the Stitch Counter Function .....	70
Setting the Embroidery Design Position when Opening .....	54	Sewing Stitch Patterns Using the Triple Stitch .....	70
Calibrating the Embroidery Hoop .....	55	Quick Reverse .....	70
Entering the Fabric Thickness .....	55	Permanent Quick Reverse .....	70
Activating/Deactivating the Function Thread Away .....	56	Backstepping .....	71
Programming Securing Stitches (Smart Secure) .....	56	5.6 Combining Stitch Patterns .....	71
Adjusting the Thread Cut .....	57	Overview Combi Mode .....	71
Changing the Measuring Unit .....	58	Creating Stitch Pattern Combinations .....	71
3.3 Selecting Personal Settings .....	58	Saving a stitch pattern combination .....	72
3.4 Monitoring Functions .....	58	Loading a Stitch Pattern Combination .....	72
Activating the Upper Thread Indicator .....	58	Overwriting a Stitch Pattern Combination .....	72
Activating the Bobbin Thread Indicator .....	59	Deleting a Stitch Pattern Combination .....	72
3.5 Activating the Audio Signals .....	59	Editing a Single Stitch Pattern .....	73
3.6 Machine Settings .....	60	Deleting a Single Stitch Pattern .....	73
Selecting a Language .....	60	Adding a Single Stitch Pattern .....	73
Adjusting the Brightness of the Display .....	60	Adapting the Stitch Pattern length and Stitch Pattern Width .....	74
Adjusting the Sewing Light .....	60	Mirroring a Stitch Pattern Combination .....	75
Reviewing the Total Number of Stitches .....	61	Stitch Pattern Combination Subdivider 1 .....	75
Registering Details of the Dealer .....	61	Stitch Pattern Combination Subdivider 2 .....	76
Saving Service Data .....	62	Securing a Stitch Pattern Combination .....	76
Back to Basic Setting .....	62	Programming Pattern Repeat .....	76
Deleting User Data .....	63	5.7 Administering Stitch Patterns .....	77
Deleting Designs on the BERNINA USB Stick .....	63	Saving Settings of Stitch Patterns .....	77
Calibrating the Buttonhole Foot #3A .....	64	Saving Stitch Patterns in Personal Memory .....	77
Packing the Embroidery Module .....	64	Overwriting Stitch Patterns from the Personal Memory .....	77
<b>4 System Settings .....</b>	<b>65</b>	Loading Stitch Patterns from the Personal Memory .....	77
4.1 Calling Up the Tutorial .....	65	Deleting Stitch Patterns from the Personal Memory .....	78
4.2 Calling Up the Creative Consultant .....	65	Saving Stitch Patterns on the BERNINA USB Stick .....	78
4.3 Using eco Mode .....	65	Uploading a Stitch Pattern from the BERNINA USB Stick .....	78
4.4 Calling Up the Help .....	65	Deleting Stitch Patterns from the BERNINA USB Stick .....	79
4.5 Cancelling Any Alterations with «clr» .....	65	5.8 Securing Stitches .....	79
<b>5 Creative Sewing .....</b>	<b>66</b>	Securing via the Icon «Securing» .....	79
5.1 Overview Selection Menu Sewing .....	66	Securing with the Button «Pattern End» .....	79
Selecting a Stitch Pattern .....	66	5.9 Height Compensation of Uneven Layers .....	79
5.2 BERNINA Dual Feed .....	66	5.10 Sewing Corners .....	80
5.3 Regulating the Speed .....	67	<b>6 Practical Stitches .....</b>	<b>81</b>
5.4 Adjusting the Upper Thread Tension .....	67	6.1 Overview Practical Stitches .....	81
5.5 Editing Stitch Patterns .....	68	6.2 Sewing Straight Stitch .....	83
Changing the Stitch Width .....	68	6.3 Securing with the Automatic Securing Program .....	84
Changing the Stitch Length .....	68	6.4 Sewing in the Zipper .....	84
Correcting the Balance .....	68	6.5 Sewing Both Sides of the Zipper from Bottom to Top .....	85



6.6	Sewing Triple Straight Stitch .....	86	9.8	Determining the Buttonhole Length with the Buttonhole Foot with Slide #3A .....	111
6.7	Sewing Triple Zigzag .....	87	9.9	Determining the buttonhole length with Buttonhole Foot #3C .....	111
6.8	Manual Darning .....	87	9.10	Sewing a Buttonhole Automatically .....	112
6.9	Automatic Darning .....	89	9.11	Programming the Heirloom Buttonhole .....	113
6.10	Reinforced Darning, Automatic .....	90	9.12	Sewing the manual 7-step buttonhole with the Buttonhole Foot #3C .....	113
6.11	Reinforced Darning .....	90	9.13	Sewing the Manual 5-step Buttonhole with the Buttonhole Foot #3C .....	114
6.12	Finishing Edges .....	91	9.14	Cutting the Buttonhole Open with the Seam Ripper .....	115
6.13	Sewing Double Overlock .....	92	9.15	Cutting Open Buttonholes with the Buttonhole Cutter (Optional Accessory) .....	115
6.14	Narrow Edgestitching .....	92	9.16	Sewing on a Button .....	115
6.15	Wide Edgestitching .....	92	9.17	Sewing Eyelets .....	116
6.16	Edgestitching Using the Seam Guide .....	93	<b>10</b>	<b>Quilting .....</b>	<b>117</b>
6.17	Sewing Hem Edges .....	93	10.1	Overview Quilt Stitches .....	117
6.18	Sewing Blind Hems .....	94	10.2	Quilting, Securing Program .....	118
6.19	Sewing Visible Hems .....	95	10.3	Sewing Handlook Quilt Stitches .....	118
6.20	Sewing Flat Joining Seams .....	96	10.4	Guiding the Quilt Work Freely .....	119
6.21	Sewing Basting Stitches .....	96	<b>11</b>	<b>BERNINA Stitch Regulator (BSR) .....</b>	<b>120</b>
<b>7</b>	<b>Decorative Stitches .....</b>	<b>97</b>	11.1	BSR Mode 1 .....	120
7.1	Overview Decorative Stitches .....	97	11.2	BSR Mode 2 .....	120
7.2	Bobbin-Play .....	98	11.3	BSR Function with Straight Stitch No. 1 .....	120
7.3	Sewing Cross Stitches .....	99	11.4	BSR Function with Zigzag No. 2 .....	120
7.4	Pintucks .....	99	11.5	Sewing Preparations for Quilting .....	120
	Pintucks .....	99		Attach the BSR Presser Foot .....	120
	Overview Pintuck Feet .....	100		Changing the Presser Foot .....	121
	Working with Cord .....	101	11.6	Using the BSR Mode .....	121
	Sewing Pintucks .....	102	11.7	Securing Stitches .....	122
<b>8</b>	<b>Alphabets .....</b>	<b>103</b>		Securing in BSR1 Mode with the Button «Start/Stop» ...	122
8.1	Overview Alphabet .....	103		Securing in BSR2 Mode .....	122
8.2	Creating Lettering .....	103	<b>12</b>	<b>My BERNINA Embroidery .....</b>	<b>124</b>
8.3	Alter Font Size .....	104	12.1	Overview Embroidery Module .....	124
<b>9</b>	<b>Buttonholes .....</b>	<b>105</b>	12.2	Supplied Accessories Embroidery Module .....	124
9.1	Overview Buttonholes .....	105		Overview Accessory Embroidery Module .....	124
9.2	Making Use of the Height Compensation Tool .....	106	12.3	Overview User Interface .....	126
9.3	Using the Compensation Plate .....	106		Overview Functions/Visual Information .....	126
9.4	Marking Buttonholes .....	107		Overview System Settings .....	126
9.5	Cord .....	108		Overview Selection Menu Embroidery .....	126
	Using Cord with the Buttonhole Foot with Slide #3A ..	108			
	Using cord with the Buttonhole Foot #3C .....	109			
9.6	Sewing a Test Sample .....	110			
9.7	Determining the Buttonhole Slit Width .....	110			



12.4	Important Embroidery Information .....	127	<b>14</b>	<b>Setup Program .....</b>	<b>142</b>
	Upper Thread .....	127	14.1	Adjusting the Embroidery Settings in the Setup Program .....	142
	Bobbin Thread .....	127	<b>15</b>	<b>Creative Embroidering .....</b>	<b>143</b>
	Selecting the Embroidery File Format .....	128	15.1	Overview Embroidering .....	143
	Embroidery Test .....	128	15.2	Selecting and Changing the Embroidery Design .....	143
	The Size of the Embroidery Design .....	128	15.3	Checking the Embroidery Time and the Embroidery Design Size .....	143
	Embroidering Designs by Third-party Providers .....	128	15.4	Regulating the Speed .....	143
	Underlay Stitches .....	128	15.5	Editing the Embroidery Design .....	144
	Satin or Leaf Stich .....	129		Overview Editing Embroidery Design .....	144
	Step Stitch .....	129		Scaling Up the Embroidery Design View .....	144
	Connecting Stitches .....	130		Downsizing the Embroidery Design .....	144
<b>13</b>	<b>Embroidering Preparation .....</b>	<b>131</b>		Moving the Embroidery Design View .....	145
13.1	Attaching the Embroidery Module .....	131		Moving the Embroidery Design in Enlarged View .....	145
13.2	Removing the Embroidery Module .....	131		Moving the Embroidery Design .....	145
13.3	Preparing the Machine .....	132		Rotating the Embroidery Design .....	146
	Lower the Feed-dog .....	132		Altering the Embroidery Design Size Proportionally .....	146
	Selecting the Embroidery Design .....	132		Altering the Embroidery Design Size Disproportionally ..	146
13.4	Embroidery Foot .....	132		Mirroring Embroidery Designs .....	147
	Attaching the Embroidery Foot .....	132		Changing the Stitch Type .....	147
	Selecting the Stitch Plate in the User Interface .....	133		Altering the Stitch Density .....	148
13.5	Needle and Stitch Plate .....	134		Checking the Size and the Position of the Embroidery Design .....	148
	Inserting the Embroidery Needle .....	134		Duplicating the Embroidery Design .....	149
	Selecting the Embroidery Needle in the User Interface ..	134		Deleting an Embroidery Design .....	149
	Selecting Needle Type and Needle Size .....	134	15.6	Combining Embroidery Designs .....	150
	Adjusting the Needle Position Up/Down .....	135		Combining Embroidery Designs .....	150
	Attaching the Stitch Plate .....	135		Deleting a Single Embroidery Design .....	150
	Selecting the Stitch Plate in the User Interface .....	136		Duplicating a Combination .....	150
	Thread-up Command .....	136	15.7	Creating Lettering .....	151
13.6	Embroidery Hoop .....	136		Overview Embroidery Alphabets .....	151
	Overview Embroidery Hoop Selection .....	136		Creating Lettering .....	152
	Selecting the Embroidery Hoop .....	136		Editing the Lettering .....	152
	Tear-away Stabilizers .....	137	15.8	Changing the Colors of the Embroidery Design .....	153
	Cut-away Stabilizers .....	137		Overview Changing the Color .....	153
	Using Adhesive Spray .....	137		Changing the Colors .....	153
	Using Spray Starch .....	137		Changing the Thread Brand .....	153
	Using iron-on Interfacing .....	137	15.9	Embroidering the Embroidery Design .....	154
	Using Paper-backed Adhesive Stabilizer .....	137		Overview Embroidery Menu .....	154
	Using Water-soluble Stabilizer .....	138		Adding Basting Stitches .....	154
	Preparing the Embroidery Hoop .....	138		Moving the Hoop .....	154
	Attaching the Hoop .....	139		Embroidery Sequence Control when the Thread Breaks .....	155
	Overview Embroidery Functions .....	140		Cutting Connecting Stitches .....	155
	Centering the Needle to the Embroidery Hoop .....	140		Reducing Color Changes .....	155
	Move Hoop to the Back .....	140		Multi-colored Embroidery Design On/Off .....	155
	Moving the Module for the Sewing Mode .....	140			
	Grid On/Off .....	141			
	Locating the Center of the Embroidery Design .....	141			
	Virtual Positioning of the Embroidery Hoop .....	141			

Color Indication .....	156	<b>20</b>	<b>Technical Data .....</b>	<b>177</b>
15.10 Freearm Embroidery .....	156	<b>21</b>	<b>Overview Stitch Patterns .....</b>	<b>178</b>
15.11 Administering Embroidery Designs .....	157	21.1	Overview Stitch Patterns .....	178
Administering Embroidery Designs .....	157		Practical Stitches .....	178
Saving Embroidery Designs in the Personal Memory ....	157		Buttonholes .....	178
Saving the Embroidery Design on the BERNINA USB Stick .....	157		Decorative Stitches .....	178
Overwriting the Embroidery Design in the Personal Memory .....	158		Quilt Stitches .....	181
Overwriting the Embroidery Design on the BERNINA USB Stick .....	158	21.2	Overview Embroidery Designs .....	182
Importing Stitch Patterns .....	158		Editing the Embroidery Design .....	182
Loading an Embroidery Design from the Personal Memory .....	159		Quilt Designs .....	182
Loading an Embroidery Design from the BERNINA USB Stick .....	159		Embellishment .....	187
Deleting an Embroidery Design from the Personal Memory .....	159		Flowers .....	191
Deleting an Embroidery Design from the BERNINA USB Stick .....	159		Children .....	193
<b>16 Embroidery .....</b>	<b>160</b>		Borders and Lace .....	197
16.1 Embroidering via the Button «Start/Stop» .....	160		Seasons .....	199
16.2 Increasing the Embroidery Speed .....	160		Sport and Hobbies .....	203
16.3 Adjusting the Upper Thread Tension .....	160		Animals .....	205
16.4 Embroidering via the Foot Control .....	161		Hoops .....	206
<b>17 Care and Maintenance .....</b>	<b>162</b>		DesignWorks .....	208
17.1 Firmware .....	162		Kaffe Fassett Stitches .....	210
Checking the Firmware Version .....	162		<b>Index .....</b>	<b>214</b>
Updating Firmware .....	162			
Recovering Saved Data .....	163			
17.2 Machine .....	163			
Cleaning the Display .....	163			
Cleaning the Feed Dog .....	163			
Cleaning the Hook .....	164			
Lubricating the Hook .....	165			
Cleaning the Thread Catcher .....	167			
<b>18 Errors and Faults .....</b>	<b>168</b>			
18.1 Error Messages .....	168			
18.2 Troubleshooting .....	173			
<b>19 Storage and Disposal .....</b>	<b>176</b>			
19.1 Storing the Machine .....	176			
19.2 Dispose of the Machine .....	176			





# IMPORTANT SAFETY INSTRUCTIONS

Please be aware of the following basic safety instructions when using your machine. Before using this machine, read instruction manual carefully.

## DANGER

To protect against electric shock, the following instructions must be observed.

- Never leave the machine unattended when it is connected to the power supply.
- Immediately after use and before cleaning, switch off the machine and disconnect the power cable from the outlet.

In order to protect against injury, the following instructions must be adhered to.

- Do not look directly into the LED lamp with optical instruments (e. g. magnifying glass).
- If the LED lamp is damaged or defective, have the LED lamp checked or repaired at your local authorized BERNINA dealer.
- Switch off the machine before working in the needle area.
- Before starting the machine, close all covers.

## WARNING

To reduce the risk of burns, fire, electric shock or injury to persons, the following instructions must be observed.

### General Facts

- This machine may only be used for the purpose described in this instruction manual.

### Working Environment

- Do not use the machine outdoors.
- Only use the machine in dry rooms.
- Do not use the machine in a humid area.
- Do not use the machine in rooms where aerosol products (sprays) are being used.
- Do not use the machine in rooms where oxygen is dispensed.

### Technical Condition

- Never use the machine when it is damp.
- Do not use the machine if it is not working properly.



- Do not use the machine if a cable or the plug is damaged.
- Do not use the machine if it has been dropped, damaged or has fallen into water.
- If the machine is damaged or does not work properly, have the machine checked or repaired by your local authorized BERNINA dealer.
- Keep all ventilation openings of the machine and the foot control free of lint, dust and loose cloth.
- Do not use the machine if the ventilation openings are blocked.

#### **Accessories and Supplies**

- Only use the accessories recommended by the manufacturer.
- Always use the original BERNINA Stitch Plate.  
An incorrect stitch plate can result in needle breakage.
- Use only straight needles of good quality.  
Bent or damaged needles can cause needle breakage.
- This machine is double-insulated (except for USA, Canada and Japan).  
Use only identical replacement parts. See instructions for Servicing of double-insulated products.
- To lubricate the machine, only use oil recommended by BERNINA.

#### **Safety Instructions**

- While operating the machine, all protective inserts must be in place and all covers must be closed.

#### **Appropriate Use**

- The machine may be used, cleaned and maintained by children older than eight or by people with reduced physical, sensory or mental capabilities or if there is a lack of experience and knowledge as long as they have been given instructions.
- Furthermore, these persons must be supervised while working with the machine, and/or they must know the safe operation of the machine and be aware of the resulting hazards.
- Children are not allowed to play with the system.
- Special care should be taken when the machine is operated by or in the presence of children.
- Only use the machine with the supplied power cable.
- USA and Canada only: Do not connect power plug NEMA 1-15 to circuits exceeding 150 volt-to-ground.
- Only use this machine with the supplied foot control of type LV-1.
- Do not insert any objects into the openings of the machine.

- Do not place any objects on the foot control.
- While sewing, guide the fabric gently.  
Pulling and pushing the fabric can cause needle breakage.
- Keep fingers away from all moving parts.
- Special care is required in the needle area.
- For activities in the needle area - such as threading the needle, changing the needle, threading the looper or changing the presser foot - switch off the machine.
- To switch off, set the power switch to «0».
- When protective covers are removed, when the machine is oiled or when other cleaning and maintenance operations mentioned in this instruction manual are carried out, switch off the machine and disconnect the power plug from the outlet.
- Pull the plug out of the outlet by pulling on the plug. Do not pull on the cable.

## Safety Signs on the Machine

Safety signs	Purpose
<div style="display: flex; justify-content: space-between;"> <div style="width: 45%;"> <p><b>ATTENTION</b> Pièces en rotation! Pour réduire les risques de blessure. Déconnecter avant toute opération d'entretien.</p> </div> <div style="width: 45%;"> <p><b>CAUTION</b> Moving Parts! To reduce risk of injury. Switch off before servicing.</p> </div> </div>	<p>Caution; moving parts.</p> <p>To reduce the risk of injury, switch off the machine before maintenance work.</p>



## Important Information

### Availability of the Instruction Manual

The instruction manual is supplied with the machine.



- Keep the instruction manual safe at a suitable place near the machine to have it at hand in case that you need to look up something.
- If you pass the machine to a third party, always include the instruction manual.
- The latest version of the instruction manual can be downloaded at [www.bernina.com](http://www.bernina.com)

### Proper Use

Your BERNINA machine is conceived and designed for private household use. It is intended for sewing fabrics and other materials as described in this instruction manual. Any other use is not considered proper. BERNINA assumes no liability for consequences resulting from improper use.


### Equipment and Scope of Delivery

Example images are used in these instructions for the purposes of illustration. The machines shown in the images and the accessories shown therefore do not always match the actual items included with your machine. The supplied accessory can vary depending on the country of delivery. You can acquire any accessories mentioned or shown that are not included in the scope of delivery as optional accessories from a specialist BERNINA dealer. Further accessories can be found at [www.bernina.com](http://www.bernina.com).

For technical reasons and in order to improve the product, changes may be made to the equipment of the machine and the scope of delivery at any time and without prior notice.

### Maintenance of Double-insulated Products

In a double-insulated product two systems of insulation are provided instead of grounding. No grounding means is provided on a double-insulated product nor should a means for grounded be added to the product. Servicing a double-insulated product requires extreme care and knowledge of the system and should only be done by qualified service personnel. Replacement parts for a double-insulated product must be identical to the original parts in the product. A double-insulated product is marked with the words: «Double-Insulation» or «double-insulated».

 The symbol may also be marked on the product.

### Environmental Protection

BERNINA International AG is committed to environmental protection. We strive to minimize the environmental impact of our products by continuously improving product design and our technology of manufacturing.



The machine is labeled with the symbol of the crossed-out wastebin. This means that the machine should not be disposed of in household waste when it is no longer needed. Improper disposal can result in dangerous substances getting into the groundwater and thus into our food chain, damaging our health.

The machine must be returned free of charge to a nearby collection point for waste electrical and electronic equipment or to a collection point for the reuse of the machine. Information on the collection points can be obtained from your local administration. When purchasing a new machine, the dealer is obliged to take back the old machine free of charge and dispose of it properly.

If the machine contains personal data, you are responsible for deleting the data yourself before returning the machine.





# 1 My BERNINA

## 1.1 Introduction

The purposes of your BERNINA 570 QE are sewing, embroidering and quilting. Delicate silk or satin fabrics as well as heavyweight linen, fleece and denim can be sewn without any problems with this machine.

Numerous practical as well as decorative stitches, buttonholes and embroidery designs are at your disposal.

In addition to this instruction manual, following Help Programs are provided at any time to give you useful advice and support how to operate your BERNINA 570 QE.

The **Tutorial** gives information and explanations about various aspects of sewing and embroidering as well as the different stitches.

The **Creative Consultant** informs you about decision support for sewing projects. After entering the choice of fabric and the intended sewing project, suggestions concerning the suitable needle or the appropriate presser foot are displayed.

The **Help Program** provides information about individual stitch patterns, functions and operations in the User Interface.

### Further Information



In addition to this instruction manual for your BERNINA 570 QE, further informative print media are enclosed.

The current version of your manual as well as many other information about the machine and the accessories can be found on our website <https://www.bernina.com>

## 1.2 BERNINA Quality Control

All BERNINA machines are assembled with utmost care and are subjected to an extensive functionality test. The integrated stitch counter therefore indicates that the machine has already sewn stitches, which were performed exclusively for test purposes and quality control. The subsequent thorough cleaning does not exclude the possibility that thread remnants may still be found in the machine.

## 1.3 Welcome to the World of BERNINA

Made to create, this is the slogan of BERNINA. Not only with our machines do we support you in the implementation of your ideas. In addition to the offers listed below, we offer you lots of suggestions and instructions for your future projects as well as the opportunity to exchange ideas with other sewing, quilting and embroidery enthusiasts. We wish you lots of pleasure.

### BERNINA YouTube Channel



On YouTube we offer a wide range of how-to videos and support concerning the most important functions of our machines. You can also find detailed explanations many presser feet, meaning that your projects will be a complete success.

<https://www.youtube.com/BerninaInternational>

Available in English and German.

### inspiration – the Sewing Magazine in the Online Shop



Are you looking for ideas, sewing patterns and instructions for great sewing projects? In this case, the BERNINA magazine «inspiration» is exactly what you need. Three times a year, inspiration offers fantastic sewing and embroidery ideas. From seasonal fashion trends to trendy accessories and practical tips to original decorations for your home or cute sewing ideas for children.

The magazine is available in English, German, Dutch, and French.

In our online shop you can purchase "inspiration" as an e-magazine or as a print version, either as individual issues or as a subscription. Furthermore, there are many individual downloadable cutting patterns to discover! Please have a look at <https://www.bernina.com/inspiration>

### **BERNINA Blog**



Subtle instructions, free cutting patterns and embroidery designs as well as many new ideas: All this you can find in the weekly blog of BERNINA. Our experts give useful tips and explain step by step how you can achieve the desired result. In the community you can upload your own projects and exchange experiences and ideas with other sewing and embroidering enthusiasts.

<https://www.bernina.com/blog>

Available in English, German, Dutch and French.

### **BERNINA Social Media**



Follow on social networks to learn more about events, thrilling projects as well as tips and tricks all about sewing, quilting and embroidering. We will keep you informed and we are looking forward to presenting you the one or the other highlight from the world of BERNINA.

<https://www.bernina.com/social-media>



## 1.4 Overview Machine

### Overview Front Controls



- |   |                        |   |                              |
|---|------------------------|---|------------------------------|
| 1 | «Quick Reverse»        | 6 | «Needle position Up/Down»    |
| 2 | «Thread Cutter»        | 7 | «Upper Multi-function Knob»  |
| 3 | «Presser Foot Up/Down» | 8 | «Lower Multi-function Knob»  |
| 4 | «Start/Stop»           | 9 | «Needle Position Right/Left» |
| 5 | «Pattern End»          |   |                              |



## Overview - Front



- |   |   |    |                                 |
|---|---|----|---------------------------------|
| 1 | Connection for Embroidery Module              | 8  | Speed Control                   |
| 2 | Bobbin Cover                                  | 9  | Thread Take-up Lever Cover      |
| 3 | Connection for Accessory (Optional Accessory) | 10 | Thread Take-up Lever            |
| 4 | Presser Foot                                  | 11 | Thread Cutter                   |
| 5 | Needle Threader                               | 12 | Fixing Screw                    |
| 6 | Sewing Light                                  | 13 | Connection for Slide-on Table   |
| 7 | Thread Cutter                                 | 14 | Connection for Free Hand System |

## Overview - Side Panel



- 1 Connection for Foot Control
- 2 Feed Dog Up/Down
- 3 PC-Connection
- 4 USB Port
- 5 Spool Pin
- 6 Bobbin Winding Unit

- 7 Retractable Spool Pin
- 8 Air Vents
- 9 Handwheel
- 10 Power Switch
- 11 Connection for Power Cable
- 12 Magnetic Holder for Touchscreen Pen

## Overview - Back Panel



- |   |                               |    |                          |
|---|-------------------------------|----|--------------------------|
| 1 | Air Vents                     | 9  | Bobbin Winding Unit      |
| 2 | Connection for Slide-on Table | 10 | Bobbin Winder Pretension |
| 3 | Connection for Darning Hoop   | 11 | Thread Take-up Lever     |
| 4 | BERNINA Dual Feed             | 12 | Thread Guide             |
| 5 | Carrying Handle               | 13 | Thread Cutter            |
| 6 | Spool Pin                     | 14 | BSR Connection           |
| 7 | Thread Guide Eye              | 15 | Feed Dog                 |
| 8 | Retractable Spool Pin         | 16 | Stitch Plate             |

## 1.5 Supplied Accessories

### Overview Accessories Machine


















Illustration	Name	Purpose
	Dust Cover	To protect the machine from dust and contamination.
	BERNINA Accessories Box	To store the supplied accessories as well as optional accessories.
	Free Hand System (FHS)	To raise and lower the presser foot.
	Slide-On Table	To increase the sewing surface.
	Seam Guide for Slide-On Table	To support wide topstitching of edges.
	Spool Cap	To support the regular unwinding of the thread from the spool.
	Bobbin for B9 Hook Set of 4	To wind the bobbin thread.
	Foam Pad 2 pieces	The foam pad prevents the thread from slipping, tangling or breaking on the spool pin.

Illustration	Name	Purpose
	Touchscreen Pen	For precise operation of the touch screen.
	Seam Ripper	To undo seams and to cut buttonholes open.
	Height Compensating Tool	To level an angled position of the presser foot sole when sliding over thick seams.
	Needle Assortment	For any common applications.
	Screwdriver red (slot)	To loosen and tighten slotted screws.
	Brush/Needle Inserter	To clean the feed dog and the looper area.
	Sewing Machine Oil	To oil the machine.
	Power Cable	To connect the machine with the power supply system.
	Foot Control	To start and stop the machine. To control the sewing speed.

## Overview Presser Feet

### Supplied Standard Presser Feet






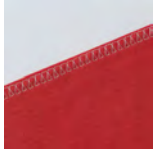





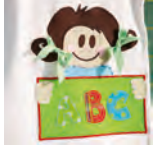

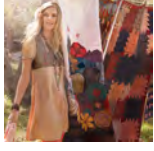


Illustration	Number	Name	Purpose	Example
	#1C	Reverse Pattern Foot	For sewing different practical and decorative stitches.  To sew forward and in reverse.	
	#1D	Reverse Pattern Foot	For sewing different practical and decorative stitches.  To sew forward and in reverse.	
	#2A	Overlock Foot	To finish edges in stretch material.	
	#3A	Buttonhole Foot with Slide	To sew buttonholes automatically.	
	#4D	Zipper Foot	For sewing in zippers.	
	#20C	Open Embroidery Foot	For sewing applications and decorative patterns.	
	#42	BERNINA Stitch Regulator (BSR)	Free-motion quilting with regular stitch length.	

Illustration	Number	Name	Purpose	Example
	#97D	Patchwork Foot	For patchwork and other exact work, if working with BERNINA Dual Feed.	

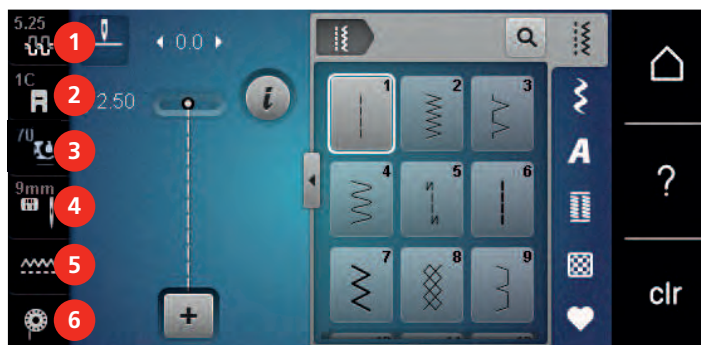
### Accessories Box



- |   |              |   |   |
|---|--------------|---|---|
| 1 | Drawer       | 5 | Foam Pad                                  |
| 2 | Presser Feet | 6 | Buttonhole Foot with Slide                |
| 3 | Spool Pin    | 7 | Needle Assortment                         |
| 4 | Spool Caps   | 8 | Holder for 5.5 mm and 9.0 mm presser feet |

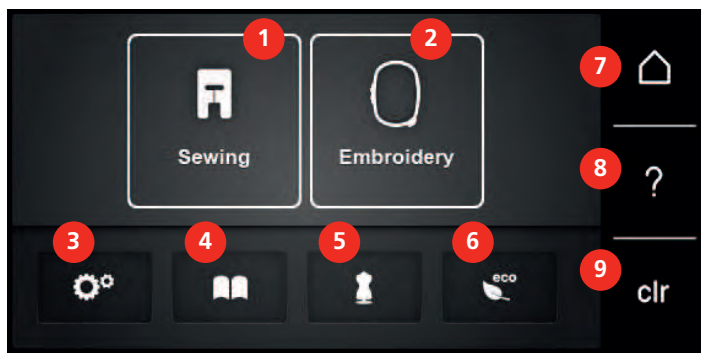
## 1.6 Overview User Interface

### Overview Functions/Visual Information



- |   |   |   |                                 |
|---|---|---|---------------------------------|
| 1 | «Upper Thread Tension»                          | 4 | «Stitch Plate/Needle Selection» |
| 2 | «Presser Foot Indicator/Presser Foot Selection» | 5 | «Feed Dog Indicator»            |
| 3 | «Foot Pressure»                                 | 6 | «Bobbin Thread»                 |

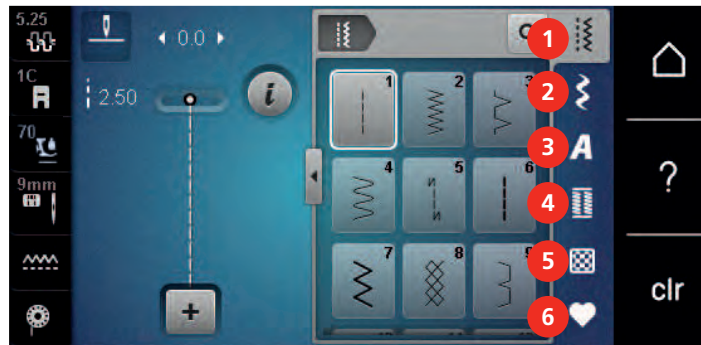
### Overview System Settings



- |   |                       |   |                  |
|---|-----------------------|---|------------------|
| 1 | «Sewing Mode»         | 6 | «eco Mode»       |
| 2 | «Embroidery Mode»     | 7 | «Home»           |
| 3 | «Setup Program»       | 8 | «Help»           |
| 4 | «Tutorial»            | 9 | «Clear Settings» |
| 5 | «Creative Consultant» |   |                  |



## Overview Selection Menu Sewing



- |   |                       |   |                   |
|---|-----------------------|---|-------------------|
| 1 | «Practical Stitches»  | 4 | «Buttonholes»     |
| 2 | «Decorative Stitches» | 5 | «Quilt Stitches»  |
| 3 | «Alphabets»           | 6 | «Personal Memory» |

## Software Operation

The touch-sensitive display can be operated with the finger or stylus.

**Tap:** Short tap of an element..





**Swipe:** Tap an element and swipe quickly on the display.

**Draw:** Tap the display and slowly move in one direction, eg. for scrolling up and down.


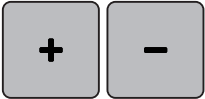

### Navigation

Illustration	Name	Purpose
	«Home»	Switch between «Home screen» and «Sewing screen».
	Navigation Path	Show a previous menu level.
	«Close»	Close the window.
	More	Show more features or information.
	Continue	Scroll to next display.
	Back	Scroll to previous display.

### Activate/Deactivate Functions

Illustration	Element	Status
	Switch	Function is activated.
		Function is deactivated.
	Icon	Function is deactivated.
		Function is activated.

### Adjust Values

Illustration	Name	Purpose
	Slider Control	Set the value with the slider control. Reset the value to the default value by tapping the small bullet.
	Field «Plus» / «Minus»	«Plus» increase, «Minus» reduce the value.
	Yellow Frame	Indication that the set value differs from the default value. Reset the value to the default value by tapping.

### Enter Text and Numbers

To enter numerical values or text, a corresponding keyboard is shown.











Illustration	Name	Purpose
	Entry Field	Display of the entry. Delete all characters entered with a single tap.

Illustration	Name	Purpose
	«Deleting»	Delete the last character.
	«Lower Case Characters»	Show the available letters in lower case letters.
	«Upper Case Characters»	Show the available letters in upper case letters.
	«Numbers and Mathematical Characters»	Show the available numbers and mathematical characters.
	«Special Characters»	Show the available special characters.
	«Confirm»	Confirm the entry and leave the submenu.
	«Cancel»	Cancel the entry and the view closes.

## 1.7 Needle, Thread, Fabric

Needles will wear down over time. Therefore, the needle should be replaced regularly. Only a perfect point results in a good stitching result. In general, the thinner the fabric, the finer the needle. The illustrated needles are either standard or optional accessory, depending on the machine.

- Needle sizes 70, 75: for light-weight fabrics.
- Needle sizes 80, 90: for medium fabrics.
- Needle sizes 100, 110 and 120: for heavy fabrics.

### Overview Needles

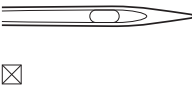
Illustration	Needle name	Needle description	Purpose
	<b>Universal Needle</b> 130/705 H 60/8 – 120/19	With a slightly rounded point.	For woven fabrics (light, medium, heavy-weight), knitwear, leather, plastic, jeans/denim. For natural and synthetic fabrics.  For general sewing, sewing on buttons and buttonholes, zippers, hems and topstitching, decorative sewing, embroidery, patchwork, quilting.

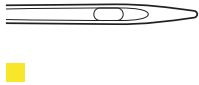
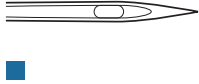

Illustration	Needle name	Needle description	Purpose
	<b>Stretch Needle</b> 130/705 H-S 75/11 – 90/14	With a medium ball point.	For knitwear (jersey, tricot, knit and stretch material).  For general sewing, sewing on buttons and buttonholes, zippers, hems and topstitching, decorative sewing, embroidery.
	<b>Jersey/ Embroidery Needle</b> 130/705 H SUK 80/12	With a medium ball point.	For woven fabrics (light, medium, heavy-weight), knitwear, plastic.  For general sewing, sewing on buttons and buttonholes, zippers, hems and topstitching, decorative sewing, embroidery.
	<b>Jeans Needle</b> 130/705 H-J 80/12 – 110/18	With slim, particularly acute point.	Woven fabrics (light, medium, heavy-weight), leather, jeans/denim.  For general sewing, sewing on buttons and buttonholes, zippers, hems and topstitching, decorative sewing, embroidery, patchwork, quilting.
	<b>Leather Needle</b> Leather Needle 90/14, 100/16	With a cutting point (LR = special point to sew leather).	For leather, imitation leather and other similar materials.  For zippers, hems and topstitching, materials that tend to stick.
	Microtex Needle 130/705 H-M 60/8 – 110/18	With a particularly pointed and slender tip.	For woven fabrics (light, medium, heavy), artificial materials and materials that are difficult to work with. For silk, microfibre fabrics, foils, coated and hard-sliding materials.  For sewing in general, sewing on buttons and buttonholes, zips, hems and topstitching and decorative sewing. For ultra straight stitches when topstitching edges.
	<b>Quilting Needle</b> 130/705 H-Q 75/11 – 90/14	With a very slim, slightly rounded point.	For woven fabrics (light, medium and heavy-weight).  Decorative sewing, patchwork, quilting. For stitching/topstitching tasks, such as quilting and patchwork.

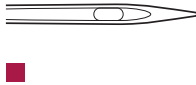
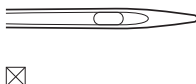
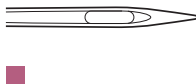
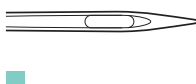
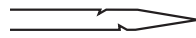
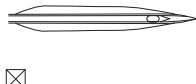
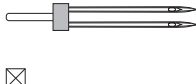
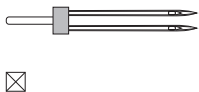
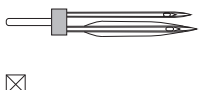
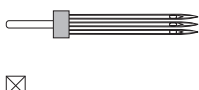
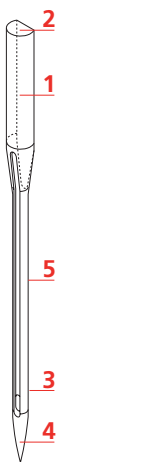
Illustration	Needle name	Needle description	Purpose
	<b>Embroidery Needle</b> 130/705 H-E 75/11 – 90/14	With a light ball point and a particularly wide eye and wide groove.	For woven fabrics (light, medium, heavy-weight), knitwear. For voluminous and woolen threads.  For general sewing, sewing on buttons and buttonholes, zippers, hems and topstitching, decorative sewing, embroidery.
	<b>Fine Fabrics Needle</b> 130/705 H SES 70/10 – 90/14	With a light ball point.	For fine, delicate materials, such as velvet.  For general sewing, sewing on buttons and buttonholes, zippers, hems and topstitching, decorative sewing, embroidery, patchwork, quilting.
	<b>Metafil Needle</b> 130/705 H METAFIL 80/12	With medium ball point and long eye (2 mm).	For woven fabrics (light, medium, heavy-weight), knitwear. For sewing with special effects and fancy threads, especially metallic threads.  For embroidery with metallic thread. For hems and topstitching, decorative sewing and embroidery.
	<b>Topstitch Needle</b> 130/705 H-N 80/12 – 100/16	With medium ball point and long eye (2 mm).	For woven fabrics (light, medium and heavy-weight).  For hems and topstitching, decorative sewing and embroidery. For decorative and quilting work with several sewing threads and also for embroidery.
	<b>Felting Needle</b> PUNCH	With small barbs.	For woven fabrics (light, medium, heavy-weight), jeans/denim.  For felting a variety of yarns and threads into base fabrics.
	<b>Hemstitch Needle</b> 130/705 H WING 100/16, 120/20	With a «wing» on each side of the needle blade.	For woven fabrics (light, medium and heavy-weight).  For special effects with hemstitch embroidery.
	<b>Universal Twin Needle</b> 130/705 H ZWI 70-100	Needle distance: 1.0/1.6/2.0/2.5/3.0/4.0/6.0/8.0	For visible hems in stretch fabrics, pintucks, decorative sewing.

Illustration	Needle name	Needle description	Purpose
	<b>Stretch Twin Needle</b> 130/705 H-S ZWI 75	Needle distance: 2.5/4.0	For visible hems in stretch fabrics, pintucks, decorative sewing.
	<b>Hemstitch Twin Needle</b> 130/705 H ZWIHO 100	Needle distance: 2.5	For special effects with hemstitch embroidery.
	<b>Universal Triple Needle</b> 130/705 H DRI 80	Needle distance: 3.0	For visible hems in stretch fabrics, decorative sewing.

### Example for Needle Description

The 130/705 system, which is the most common for household machines, is explained by the following picture of a Jersey/Stretch needle.

	<p><b>130/705 H-S/70</b></p> <p><b>130</b> = Shank length (1)</p> <p><b>705</b> = Flat shank (2)</p> <p><b>H</b> = Needle scarf (3)</p> <p><b>S</b> = Needle point (here medium ball point) (4)</p> <p><b>70</b> = Needle size 0.7 mm (5)</p>
---	---

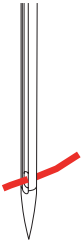
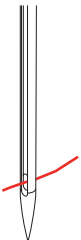
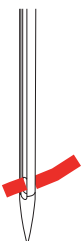
### Thread Selection

For a perfect sewing result, thread and fabric quality play an important role.

We recommend purchasing quality threads to achieve good sewing results.

- Cotton threads have the advantage of being a natural fiber and therefore are especially suitable for sewing cotton fabrics.
- Mercerized cotton threads have a slight sheen that is not lost with washing.
- Polyester threads have a high tensile strength and is particularly colorfast.
- Polyester threads are more flexible and are recommended where a strong and elastic seam is required.
- Rayon threads are made of natural fibers and have a brilliant sheen.
- Rayon threads are suitable for decorative stitches and achieve a more beautiful effect.

## Needle/Thread Combination

	<p>The needle/thread combination is correct, when the thread fits perfectly into the long groove and goes easily through the needle eye. The thread can be optimally sewn.</p>
	<p>The thread can break and skipped stitches can occur when there is too much clearance in the long groove and the needle eye.</p>
	<p>The thread can break and get stuck when the thread scrapes against the edge of the long groove not fit well into the needle eye optimally.</p>

## 2 Sewing Preparation

### 2.1 Before Using the Machine for the First Time



BERNINA recommends lubricating the hook before using the machine for the first time or after a longer period of non-use. (see page 162)

By oiling the hook, the occurrence of unwanted noises in the hook area can be avoided.

### 2.2 Accessories Box

#### Removing and Mounting the Accessory Box from Machine

The accessory box is fixed to the machine by means of four magnets. When attaching, the drawer has to be integrated in the accessory box.

- > Turn the carrying handle up and hold it in place.
- > Tilt the accessory box slightly forward and pull it off.



- > Close the doors of the accessory box.
- > Attach the accessory box to the machine, having the back towards the machine.

#### Storing Accessory



- > Insert the holders (1) for bobbins, feet and needles.
- > Store small parts in the drawer\_(2), e.g. oiler.

#### NOTICE

#### Scratched Sensor Surfaces of the Bobbin

Malfunction of the lower thread indicator. If the sensor surfaces of the bobbins are scratched or dirty, the bobbin thread indicator will no longer detect the low thread level.

- > Always position the bobbins in the bobbin holder with the silver sensor surface to the right.

- > Insert the bobbins into the compartment (3) of the accessory box so that the silvery sensor surfaces are on the right side.
- > To remove a bobbin, press the compartment holder down.
- > Place the small and the medium spool caps on the pin (4).
- > Store foam pads in the compartment (5).



- > Store the Buttonhole Foot with Slide #3A in compartment (6).
- > Store the provided needle assortment in the special compartment (7).
- > Store the presser feet in the holders (1) (5.5 mm or 9.0 mm).

## 2.3 Connection and Switching On

### Connecting the Foot Control

The cable of the foot control is rolled up on its underside.

- > Unroll the cable of the foot control to the desired length and fix it in the cable holders of the foot control..



- > Insert the plug of the cable into the foot control socket of the machine.



- > Place the foot control under the table.
- > If the cable is too long, roll up the excess length and fix it in the cable holders of the foot control.

### Connecting the Machine

To ensure safe operation of the machine, only the supplied mains cable may be used. The supplied power cable is designed for the voltage range applicable in the country of use. If the machine is to be used in a country other than the country of origin, the power cable suitable for that country must be obtained from the Authorized BERNINA dealer.

The power cable for the USA and Canada has a polarized power plug (one contact is wider than the other). To reduce the risk of an electric shock, the plug can only be inserted into the socket in one way. If the power plug does not fit in the socket, reverse then insert the power plug. If the reversed power plug still does not fit, an electrician must install an appropriate socket. Do not modify the power plug in any way.

- > Insert the device connector of the power cable into the machine's power cable connection.



- > Insert the power plug of the power cable into the socket.

### Attaching the Knee Lifter of the Free Hand System



The lateral position of the lever can be adjusted by your local BERNINA Dealer required.

- > Insert the knee lifter into the opening at the front side of the machine.
- > Adjust the sitting height so that the knee lifter can be operated with the knee.



### Fixing the Touch Screen Pen

- > Store the touchscreen pen at the magnet holder.



### Switching the Machine On

- > Set the Power Switch to «I».



## 2.4 Foot Control

### Regulating the Speed via the Foot Control

Via the foot control the speed can be adjusted infinitely variable.

- > Press the foot control down carefully to start the machine.
- > To sew faster, press the foot control harder.
- > Release the foot control to stop the machine.



### Activate/Deactivate Additional Function

The Foot Control can be programmed with a second function that can be activated and deactivated by a Back-kick. On delivery, the Back-kick is programmed with the function «Needle Up/Down».

- > To raise or lower the needle, press the foot control downward with your heel.



The Back-kick function can be programmed individually. (see page 53)

## 2.5 Spool Pin

### Retractable Spool Pin

Raise the Retractable Spool Pin



With metallic or other special threads, it is recommend to use the retractable spool pin.

The retractable spool pin is required when sewing with multiple threads, and can be used for spooling while sewing.

- > To raise the spool pin, push the spool pin down and release it.



- > To lock the spool pin, turn the spool pin anti-clockwise as far as it will go.
- > To release the lock, turn the spool pin clockwise as far as it will go.
- > To lower the spool pin, push the spool pin down until it clicks into place.

#### Inserting Foam Pad and Thread Spool

The foam pad prevents the thread from getting hooked at the spool pin.

- > Place the foam pad on the spool pin.
- > Place the thread spool on the spool pin.



#### Horizontal Spool Pin

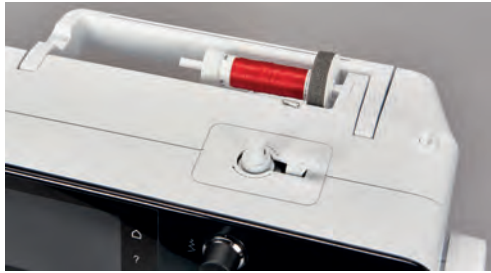
##### Placing the Foam Pad, the Thread Spool and the Spool Cap

Spool caps hold the thread spool in place for proper release of thread from the spool. The spool cap is only used with the horizontal spool holder.

- > Place the foam pad on the spool pin.
- > Place the thread spool on the spool pin.



- > Position the appropriate spool cap on the spool pin so that there is no space between the spool cap and the thread spool.



### Using the Spool Net

The spool net holds the thread on the thread spool and prevents the thread from knotting and breaking.

- > If available, slide the spool net over the thread spool. Ensure when doing so that the spool net does not slip off the thread spool, e.g. double-insert the net over the thread spools or insert a part of the net into the thread spool at the rear.



## 2.6 Feed Dog

### Adjusting the Feed Dog

- > To lower the feed dog, push the button «Feed Dog Up/Down».



- > To raise the feed dog, push the button «Feed Dog Up/Down» again.

## 2.7 Slide-on Table

### Using the Slide-on Table

The Slide-on Freearm Extension Table, attached to the freearm, enables the available sewing area to be extended.

- > Raise the needle.
- > Raise the presser foot.
- > Switch off the machine.

- > Push the Slide-on Freearm Extension Table from the left to the right over the freearm until it engages.



- > To remove the Slide-on Freearm Extension Table, press the button at the table down and pull the slide-on table over the free arm to the left.



### Using the Seam Guide

The seam guide for the slide-on table facilitates sewing of evenly wide edges and hems.

Prerequisite:

- The slide-on table has been fitted.
- > Touch the release button and engage the seam guide from the front to the back on the slide-on table.

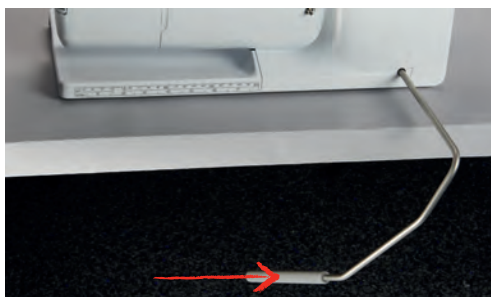


- > To determine the edge width, press the release button and move the seam guide to the right or left.
- > Touch the release button and pull the seam guide away to the front.

## 2.8 Presser Foot

### Adjusting the Presser Foot Position via the Knee Lifter of the Free Hand System

- > Adjust the sitting height so that the knee lifter can be operated with the knee.
- > Push the knee lifter with the knee to the right to raise the presser foot.



- Simultaneously the feed dog is lowered and the thread tension is released.
- > Release the knee lifter slowly to lower the presser foot.

## Adjusting the Presser Foot Position via the Button «Presser Foot Up/Down»



- > To raise the presser foot, push the button «Presser Foot Up/Down».
- > To lower the presser foot, push the button «Presser Foot Up/Down» again.

## Changing the Presser Foot

- > Raise the needle.
- > Raise the presser foot.
- > Switch the machine off.
- > Push the clamping lever up (1).
- > Remove the presser foot (2).



- > Guide the new presser foot upwards over the cone.
- > Press the clamping lever down.

## Selecting the Presser Foot in the User Interface

After changing the presser foot, a check can be performed to determine whether it is suitable for the selected stitch pattern. Additionally, alternative presser feet are displayed, which are available for the selected stitch pattern.

- > Switch the machine on.
- > Select the stitch pattern.
- > Tap «Presser Foot Indicator/Presser Foot Selection».



- > To display all suitable presser feet for the selected stitch pattern, tap «Optional Presser Feet».



- > Select the attached presser foot.
  - When the selected presser foot is suitable, sewing can start.
  - If the selected presser foot is not suitable for the selected stitch pattern, it can still be selected but the machine is automatically prevented from starting. An error message is displayed. If an incorrect presser foot is selected, the sewing stitch is displayed in red in the sewing stitch preview.



### Setting the Presser Foot Pressure



The presser foot pressure is designed to adjust the pressure of the presser foot optimally to the fabric thickness. When working with thick fabrics, it is recommended to reduce the presser foot pressure. This provides the advantage that the fabric can be moved more easily. When the presser foot pressure is set below 0, the presser foot even lifts to give more space to the thick fabric. When working with thin fabrics, it is recommended to increase the presser foot pressure. This provides the advantage that the fabric cannot be moved too easily under the presser foot.



- > Tap «Foot Pressure».
- > Adjust the presser foot pressure.

## 2.9 Adjusting the Feed Dog



- > Tap «Feed Dog Indicator».
- > Raise or lower the feed dog according to the animation.

## 2.10 Needle and Stitch Plate

### Changing the Needle

- > Switch the machine off.
- > Remove the presser foot.
- > Loosen the fixing screw for the needle by hand.



- > Pull the needle down.
- > Hold the new needle with the flat side to the back.
- > Insert the needle as far as it will go.
- > Tighten the fixing screw by hand.



## Selecting the Needle in the User Interface

After changing the needle, you can check whether this can be used with the selected stitch plate.



- > Tap «Stitch Plate/Needle Selection».
- > Select the fitted needle.



- If the selected needle is suitable in combination with the selected presser foot, sewing can be started. If the selected needle does not correspond with the selected presser foot, there will be an error message when switching on the machine, and the machine will not start.

## Selecting the Needle Type and the Needle Size

Useful reminder function: So that no information is lost, the needle type and needle thickness can also be saved on the machine. This means that the saved needle type and needle thickness can be checked at any time.



- > Tap «Stitch Plate/Needle Selection».



- > Tap «Needle Selection».



- > Select the needle type (1) of the fitted needle.
- > Select the needle type (2) of the fitted needle.

## Adjusting the Needle Position Up/Down



- > To lower the needle, push the button «Needle position Up/Down».
- > To raise the needle, push the button «Needle position Up/Down» again.

## Adjusting the Needle Position Left/Right

There is a total of 11 needle positions. The needle position is indicated by the needle position number in the display.

- > To position the needle position to the left, push the button «Needle Position Left» (1).

- > To position the needle position to the right, push the button «Needle Position Right» (2).



### Needle Stop Up/Down (permanent)



- > To set the needle stop position permanently, tap «Needle Stop Up/Down».
  - The machine stops with needle position down as soon as the foot control is released or the button «Start/Stop» has been pushed.
- > Tap «Needle Stop Up/Down» again.
  - The machine stops with needle position up as soon as the foot control is released or the button «Start/Stop» has been pushed.

### Changing the Stitch Plate

The stitch plate is marked with vertical, horizontal and diagonal lines in millimeters (mm) and inches (inch). These markings are helpful for sewing or precise top-stitching.

Prerequisite:

- The feed dog is lowered.
  - The machine is switched off.
  - The needle and presser foot are removed.
- > At the marking on the upper right corner of the stitch plate, push the stitch plate downwards until it tips.

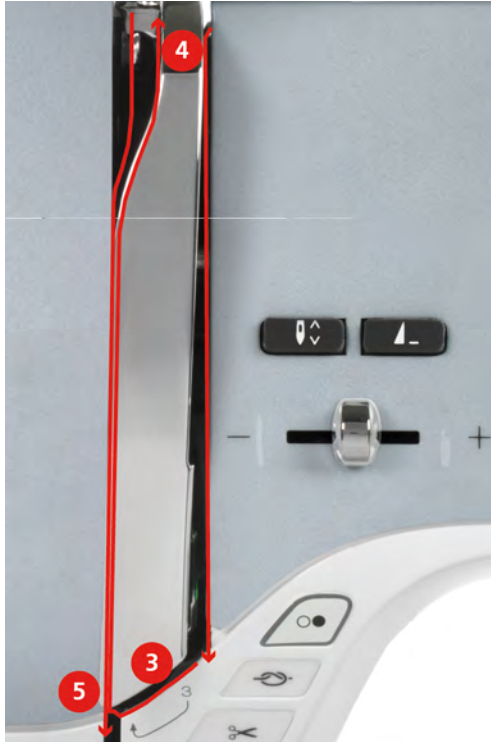


- > Remove the stitch plate.





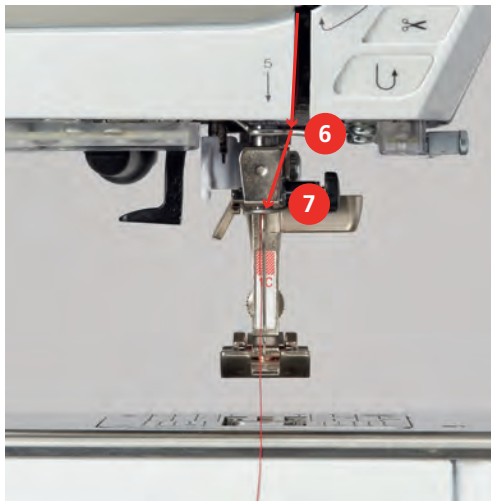
- > Insert the thread in the thread take-up lever (4).



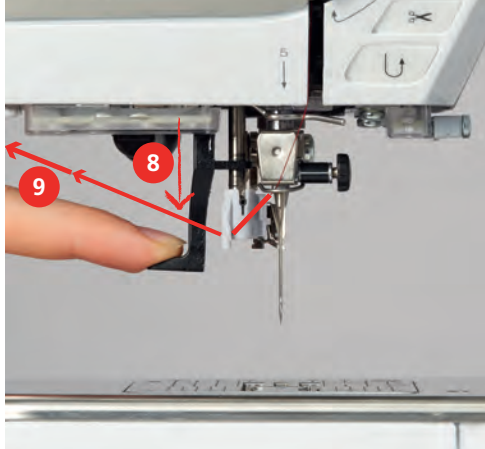
- > Guide the thread downwards again (5).
- > Only release the thread now.
- > Switch the machine off.

### Threading the Needle

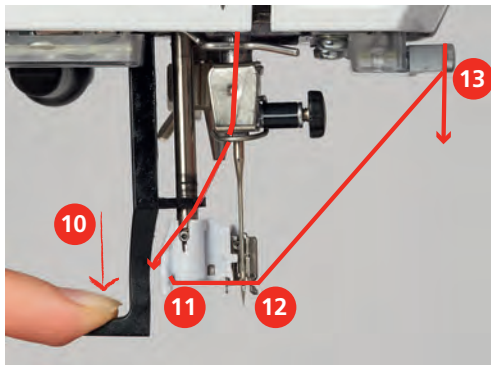
- > Guide the thread through the guides (6/7) above the presser foot.



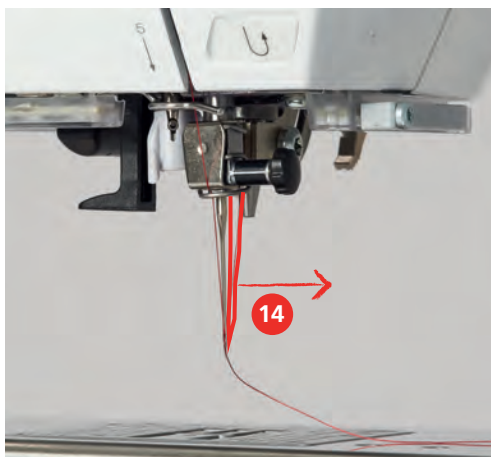
- > Push the semi-automatic needle-threading lever (8) halfway down and pull the thread behind the grey needle-threading finger/hook to the left (9).



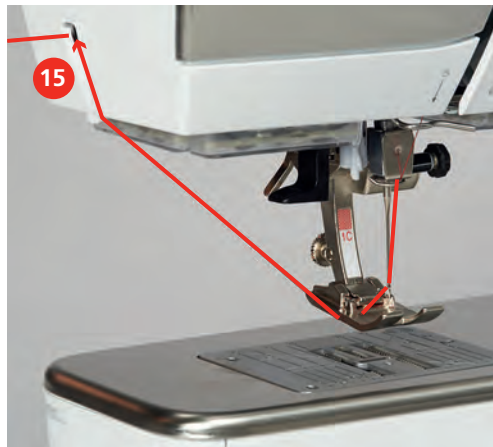
- > Guide the thread from the left to the right in front of the gray needle-threading finger/hook (11).
- > Push the needle-threading lever down as far as it will go (10).
- > Pull the thread from left to right (11) through the needle-threading slot (12) until it catches on the wire hook.
- > Pull the thread over the thread cutter (13) from the back and cut.



- > Release the needle-threading lever.
  - The thread is pushed through the needle eye.
- > Pull the loop of thread (14) to the rear until the end of the thread is pulled through the needle.



- > Pull the thread below the presser foot and through to the thread cutter (15), and cut it.



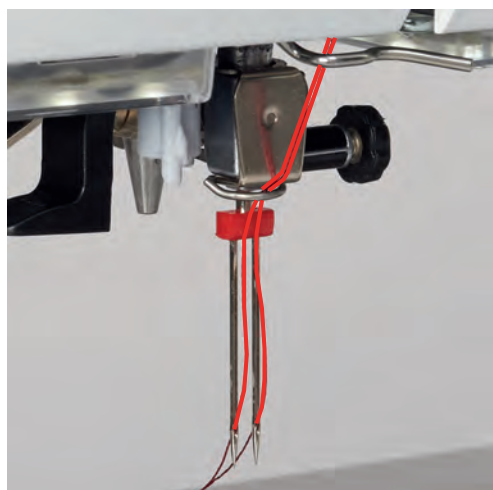
### Threading the Twin Needle

Prerequisite:

- The twin needle is inserted.
- > Guide the first thread in direction of the arrow on the right side of the tension disc (1).
- > Guide the second thread in direction of the arrow on the left side of the tension disc (1).



- > Guide the first and the second thread to the thread guide above the needle.
- > Thread the first thread manually into the right needle.
- > Thread the second thread manually into the left needle.



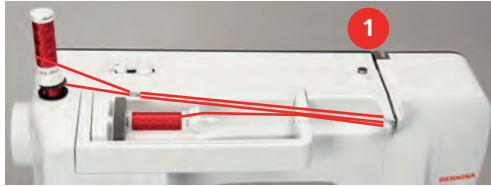
### Threading the Triple Needle

Prerequisite:

- The triple needle is inserted.
- > Place the foam pad, the thread spool and the appropriate spool cap on the horizontal spool pin.
- > Place the foam pad on the vertical spool pin.



- > Fit the filled bobbin.
- > Attach the appropriate spool cap.
- > Attach the thread spool in the opposite direction to the bobbin.
- > Thread the 3 threads up to the upper thread guide.



- > Guide 2 threads (vertical spool pin) past the thread tension disc (1) on the left and up to the thread guide above the needle.
- > Guide 1 thread (horizontal spool pin) past the thread tension disc (1) on the right and up to the thread guide above the needle.
- > Thread 1 thread of the vertical thread spool pin into the left and right needle by hand.
- > Thread the thread of the horizontal spool pin into the center needle manually.

### Winding the Bobbin Thread



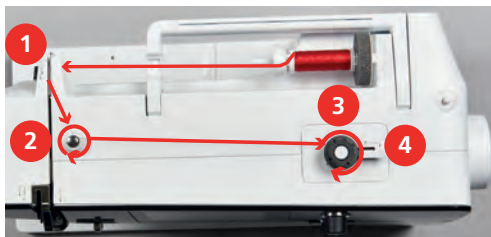
The bobbin thread can be wound while embroidering if the swiveling spool pin is used for winding.

Prerequisite:

- The foam pad, the thread spool and the appropriate spool cap are positioned.
- > Attach the empty bobbin on the winding unit so that the silvery sensor surface is down.



- > Guide the thread to the left into the rear thread guide (1).
- > Guide the thread around the bobbin winder pretension clockwise (2).
- > Wind the thread clockwise 2 – 3 times around the empty bobbin (3).
- > Pull the thread over the thread cutter at the engaging lever (4) and cut.







- > Insert the new bobbin so that the silvery sensor surface is facing the back of the bobbin case.



- > Pull the thread into the slot (2) from the left.



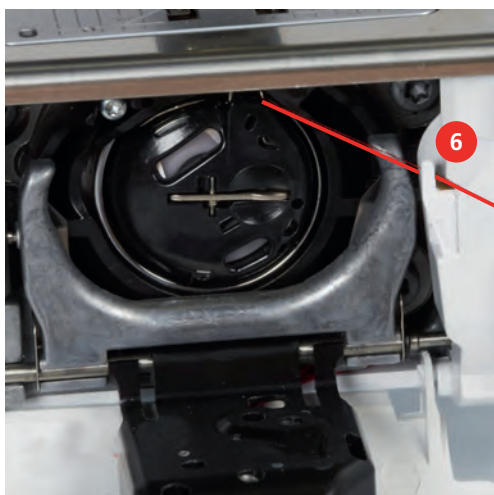
- > Pull the thread to the right under the spring (3), then pass it below the two thread guides (4) and pull it upwards.



- > To insert the bobbin case into the machine, hold it so that the thread guide (5) points upwards.



- > Insert the bobbin case.
- > Press onto the center of the bobbin case until it engages.
- > Pull the thread through the thread cutter (6) and cut.



- > Close the looper cover.

### Indicating Fill Level of Bobbin Thread

When the fill level of the bobbin thread is low, an animation appears in the icon «Bobbin Thread» to indicate that the bobbin thread is about to run out.



- > To thread the bobbin thread according to the animation, tap, «Bobbin Thread».



## 3 Setup Program

### 3.1 Sewing Settings

#### Adjusting the Upper Thread Tension

Changes to the upper thread tension in the Setup Program affect all of the stitch patterns. The setting in the setup is retained after the machine is switched off.



> Tap «Home».



> Tap «Setup Program».



> Tap «Sewing Settings».



> Tap «Adjusting the Upper Thread Tension».  
> Adjust the upper thread tension.

#### Adjusting the Maximum Sewing Speed

You can use this function to set the maximum speed.



> Tap «Home».



> Tap «Setup Program».



> Tap «Sewing Settings».



> Tap «Maximum Sewing Speed».  
> Set the maximum sewing speed.

#### Setting Securing Stitches (Smart Secure)

If the function is switched on, 4 securing stitches are automatically sewn at the start of the pattern after the thread cut.



> Tap «Home».



> Tap «Setup Program».



> Tap «Sewing Settings».



> Switch «Securing Stitches at the Start of the Pattern» on or off.

### Adjusting the Hovering Height of the Presser Foot

The hovering height of the presser foot can be adjusted according to the fabric thickness from 0 to maximal 7 mm.

Set hovering height = fabric thickness + required clearance between the fabric and the presser foot in the floating position.



> Tap «Home».



> Tap «Setup Program».



> Tap «Sewing Settings».



> Tap «Programming Buttons and Icons».



> Tap «Programming the Hovering Height of the Presser Foot».  
> Adjust the distance between the fabric and the presser foot.

### Programming the Button «Pattern End»

The presser foot can be positioned, the thread cut and the automatic securing can be programmed.



> Tap «Home».



> Tap «Setup Program».



> Tap «Sewing Settings».



> Tap «Programming Buttons and Icons».



> Tap «Programming the Button Pattern End».



## Adjusting the Presser Foot Position with Needle Stop Down

With the needle lowered, 3 different presser foot positions can be selected: Presser foot lowered, presser foot raised to hovering position and presser foot raised to maximum height.



> Tap «Home».



> Tap «Setup Program».



> Tap «Sewing Settings».



> Tap «Programming Buttons and Icons».



> Tap «Pressure Foot Position with Needle Stop Down».



> Select the desired presser foot position.

## Programming the Button «Quick Reverse»

It can be either chosen «Reverse Sewing» or «Backstepping».



> Tap «Home».



> Tap «Setup Program».



> Tap «Sewing Settings».



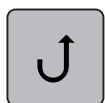
> Tap «Programming Buttons and Icons».



> Tap «Programming the Button Quick Reverse».



> To set the stitch-precise reverse sewing, tap «Backstepping».



> To set the reverse sewing, tap «Quick Reverse».

## Programming the Foot Control

If «Needle Up/Down» is activated, the needle is raised or lowered with the back-kick on the foot control. Alternatively, the presser foot can be positioned, the thread can be cut and the automatic securing can be programmed.



> Tap «Home».



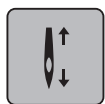
> Tap «Setup Program».



> Tap «Sewing Settings».



> Tap «Programming the Foot Control».



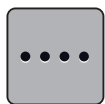
- «Needle Up/Down» is activated in the default setting.
- The back-kick on the foot control raises or lowers the needle.



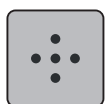
> To program the Back-kick, tap «Programming the Back-kick».



- > To deactivate the automatic securing via the Back-kick, tap «Securing Stitches».
- > To activate the automatic securing via the Back-kick, tap «Securing Stitches» again.



- > To program subsequent securing stitches, tap «Securing Stitches in Close Succession».
- > To program the number of securing stitches, tap «Minus» or «Plus».



> To program 4 securing stitches in place, tap «Securing Stitches in Place».



- > To deactivate the automatic thread cut via the Back-kick, tap «Automatic Thread Cutter».
- > To activate the automatic thread cut via the Back-kick, tap «Automatic Thread Cutter» again.



- > To keep the lowered position of the presser foot via the Back-kick, tap «Raise the Presser Foot».
- > To keep the raised position of the presser foot via the Back-kick, tap «Raise the Presser Foot» again.

## 3.2 Embroidery Settings

### Adjusting the Upper Thread Tension

Changes to the upper thread tension in the Setup Program affect all of the embroidery designs. The setting in the Setup Program is retained after the machine is switched off.





> Tap «Home».



> Tap «Setup Program».



> Tap «Embroidery Settings».



> Tap «Adjusting the Upper Thread Tension».  
> Adjust the upper thread tension.

### Adjusting the Maximum Embroidering Speed

The maximum speed can be reduced by this function.



> Tap «Home».



> Tap «Setup Program».



> Tap «Embroidery Settings».



> Tap «Maximum Embroidery Speed».  
> Set the maximum sewing speed.

### Setting the Embroidery Design Position when Opening

As the default setting, opened embroidery designs are always displayed in the center of the hoop. You can use the switch «Restore saved embroidery design position» to set that embroidery designs are opened at the position in the hoop at which they had been saved in the BERNINA stitch software.



> Tap «Home».



> Tap «Setup Program».



> Tap «Embroidery Settings».



> Tap «Centering the Embroidery Design».



> To open the embroidery design at the saved position, set the switch «Restore saved embroidery design position» to «I».



- > To open the embroidery design in the center of the hoop, set the switch «Restore saved embroidery design position» to «0».

## Calibrating the Embroidery Hoop

The calibration of the embroidery hoop is the coordination of the needle to the center of the embroidery hoop.

Prerequisite:

- The embroidery module is connected.
- The hoop is fitted with the corresponding embroidery pattern.



- > Tap «Home».



- > Tap «Setup Program».



- > Tap «Embroidery Settings».



- > Tap «Calibrating the Embroidery Hoop».
- > Use the arrow icons on the display to move the needle precisely to the center of the pattern.



- > To save the calibration, tap «Confirm».

## Entering the Fabric Thickness

If the fabric thickness is more than 4 mm, e. g. such as terry cloth, then it is recommended to choose 7.5 mm or 10 mm. The thicker the fabric, the slower the machine embroiders. When the machine is switched off, the changes are reset to the default setting of 4 mm.



- > Tap «Home».



- > Tap «Setup Program».



> Tap «Embroidery Settings».



> Tap «Entering the Fabric Thickness».  
> Select fabric thickness.

### Activating/Deactivating the Function Thread Away

To pull the thread end out of the fabric being cut, the function must be activated. For embroidery designs with long stitches, it is recommended to deactivate the function thread away. When the distance between the presser foot and the embroidery hoop is too short, the function is not carried out.



> Tap «Home».



> Tap «Setup Program».



> Tap «Embroidery Settings».



> Tap «Thread Away».



> Activating/Deactivating the function Thread Away.

### Programming Securing Stitches (Smart Secure)

Embroidery designs are programmed with or without securing stitches. If the embroidery design has programmed securing stitches, they will be embroidered. If embroidery designs are programmed with securing stitches, the securing stitches can be removed using the BERNINA Embroidery Software.



> Tap «Home».



> Tap «Setup Program».



> Tap «Embroidery Settings».





> Tap «Securing Stitches».



> To deactivate the securing stitches at the start, switch off the switch in the upper section.  
– If the embroidery design doesn't have any programmed securing stitches, none are embroidered.



> Turn on the switch in the upper section to deactivate the securing stitches at the start.  
– If the embroidery design doesn't have any programmed securing stitches, the securing stitches are added and will be embroidered.

-  > Turn off the switch in the lower section to deactivate the securing stitches at the end.
  - If the embroidery design doesn't have any programmed securing stitches, none are embroidered.
-  > Turn on the switch in the lower section to activate the securing stitches at the end.
  - If the embroidery design doesn't have any programmed securing stitches, the securing stitches are added and will be embroidered.

## Adjusting the Thread Cut

The settings for the thread cut can be customized. Deactivate the thread cut before a color change (1) or adjust the length of the connecting stitch (3). The machine does the cutting of the connecting threads at the determined length for you. First, set the length from which the connecting stitches are cut, and then select the embroidery design.



The length of the connecting thread can be adjusted between 1 mm and 15 mm, the default setting is 6 mm. This means that all connecting stitches longer than 6 mm are cut automatically. If the value is reduced to 1 mm, more thread cuts are carried out, it takes longer to embroider and more loose thread ends can be seen on the wrong side of the fabric, especially when the function 'Thread-away' is activated too. On the right side of the fabric there will be practically none or merely very short connecting stitches which results in a wonderful stitch formation. Reducing the length of the thread cut to 1 mm is particularly of advantage when embroidering texts where usually many short connecting threads occur. When both sides of the embroidery designs are visible, it may be reasonable to not reduce the length of the thread cut so much so that there won't be too many loose thread ends on the wrong side of the fabric. Loose ends get sewn over and can hardly be removed afterwards.



> Tap «Home».



> Tap «Setup Program».



> Tap «Embroidery Settings».



> Tap «Thread Cut Settings».



- > To deactivate the automatic thread cut before changing a thread, tap the switch in the upper section of the display (1).
- > To activate the automatic thread cut before changing a thread, tap the switch in the upper section of the display (1) again.
- > Tap the switch in the middle section of the display (2) so that the machine will stop after about 7 stitches and the remaining thread can be cut manually.

- > Tap the switch in the middle section of the display (2) again and the machine won't stop for a manual thread cut.
- > To adjust the length from where the connecting stitches are cut, tap «Minus» or «Plus» (3).

### Changing the Measuring Unit

The unit of measurement in the embroidery mode can be changed from mm to inches. The default setting is mm.



- > Tap «Home».



- > Tap «Setup Program».



- > Tap «Embroidery Settings».



- > Tap «Measuring Unit».
- > To display the measurements in the Embroidery Mode in inch, tap «inch».
- > To display the measurements in the Embroidery Mode in mm, tap «mm».

### 3.3 Selecting Personal Settings



- > Tap «Home».



- > Tap «Setup Program».



- > Tap «Personal Settings».
- > Select the required display color and background.
- > Tap the text box above the color settings.
- > Enter and confirm the welcome text.

### 3.4 Monitoring Functions

#### Activating the Upper Thread Indicator



- > Tap «Home».



> Tap «Setup Program».



> Tap «Monitoring Functions».



> Tap the switch in the upper section of the display to deactivate the upper thread indicator.  
> Tap the switch again to activate the upper thread indicator.

### Activating the Bobbin Thread Indicator



> Tap «Home».



> Tap «Setup Program».

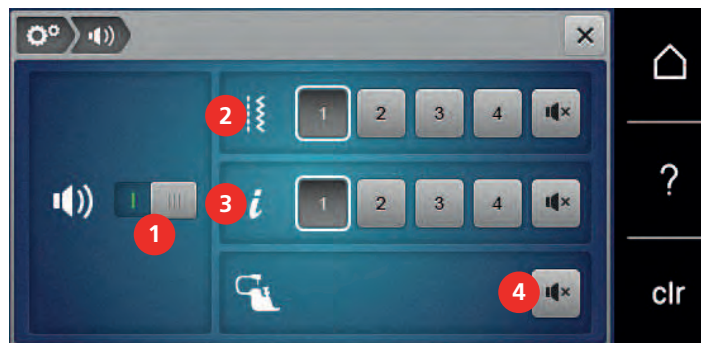


> Tap «Monitoring Functions».



> Tap the switch in the lower section of the display to deactivate the bobbin thread indicator.  
> Tap the switch again to activate the bobbin thread indicator.

### 3.5 Activating the Audio Signals



> Tap «Home».



> Tap «Setup Program».



> Tap «Setting Sound».  
> To switch all audio signals on or off, tap (1).



> To switch off the sound when selecting a stitch pattern, tap the corresponding «Switching Sounds On/Off» in area (2).  
> To switch on the sound when selecting a stitch pattern, tap the corresponding in area (2) «1 – 4».



> To switch off the sound for selecting functions, tap the corresponding «Switching Sounds On/Off» in area (3).



> To switch on the sound for selecting functions, tap the corresponding in area (3) «1 – 4».

> To deactivate the sound of the beeper when using the BSR Modes, tap «Switching Sounds On/Off» in the sector (4).

### 3.6 Machine Settings

#### Selecting a Language



> Tap «Home».



> Tap «Setup Program».



> Tap «Machine Settings».



> Tap «Language Selection».

> Tap the required language.

#### Adjusting the Brightness of the Display

The brightness of the display can be set to meet your individual needs.



> Tap «Home».



> Tap «Setup Program».



> Tap «Machine Settings».



> Tap «Display Settings».

> Adjust the brightness of the display in the upper section of the screen.

#### Adjusting the Sewing Light

The brightness of the sewing light can be adjusted corresponding to the personal preferences.



> Tap «Home».



> Tap «Setup Program».



> Tap «Machine Settings».



> Tap «Display Settings».  
> Adjust the brightness of the sewing light in the lower section of the screen.



> Tap the switch to switch the sewing light off.  
> Tap the switch again to switch the sewing light on.

### Reviewing the Total Number of Stitches

The total number of stitches by the machine and the number of stitches since the last maintenance carried out by a specialist BERNINA dealer are displayed.



> Tap «Home».



> Tap «Setup Program».



> Tap «Machine Settings».



> Tap «Information».



> Tap «Firmware and hardware information».

### Registering Details of the Dealer

The contact details for your specialized BERNINA dealer can be entered.



> Tap «Home».



> Tap «Setup Program».



> Tap «Machine Settings».



> Tap «Information».



> To enter the dealer data, tap «Dealer Data».

## Setup Program



> To enter the company name of the specialist BERNINA dealer, tap «Name».



> To enter the address of the specialized BERNINA dealer, tap «Address».



> To enter the telephone number of the specialized BERNINA dealer, tap «Phone Number».



> To enter the website or e-mail address of the specialized BERNINA dealer, tap «E-mail address».

### Saving Service Data

The service data regarding the current status of the machine can be saved on a USB stick and consequently provided to the specialized BERNINA dealer.

> Insert a USB stick which provides enough free capacity into the USB port of the machine.

> Tap «Home».



> Tap «Setup Program».



> Tap «Machine Settings».



> Tap «Information».



> Tap «Service Data».

> Tap «Export the Service Data».

– The icon «Export the Service Data» is outlined in white.

> If the white frame is no longer displayed, remove the USB stick.



### Back to Basic Setting

**CAUTION:** Using this function will delete all individually made settings.

> Tap «Home».



> Tap «Setup Program».



> Tap «Machine Settings».







> Tap «Factory Setting».



> To restore all default settings for sewing, tap «Default Setting Sewing» and confirm.



> To restore all default settings for embroidering, tap «Default Setting Embroidering» and confirm.



> To restore all default settings, tap «Default Setting Machine», confirm and restart the machine.

### Deleting User Data

Patterns which are not needed anymore can be deleted to create space for new designs.



> Tap «Home».



> Tap «Setup Program».



> Tap «Machine Settings».



> Tap «Factory Setting».



> To delete all data from the Personal Memory, tap «Delete Data from Own Storage Medium» and confirm.



> To delete all embroidery designs from the Personal Memory, tap «Delete Personal Embroidery Designs» and confirm.

### Deleting Designs on the BERNINA USB Stick

When designs which won't be needed anymore are saved on the BERNINA USB Stick, the stick can be connected to the machine and the data can be deleted.

> Insert the BERNINA USB stick into the USB port of the machine.

> Tap «Home».



> Tap «Setup Program».



> Tap «Machine Settings».



> Tap «Factory Setting».



> Tap «Deleting USB Stick» and confirm.



## Calibrating the Buttonhole Foot #3A

The Buttonhole Foot with Slide #3A is calibrated to the machine and they should only be used both together.

Prerequisite:

- The Buttonhole Foot with Slide #3A is fitted.
- The needle is not threaded.



> Tap «Home».



> Tap «Setup Program».



> Tap «Machine Settings».



> Tap «Maintenance/Update».



> Tap «Calibrating the Buttonhole Foot #3A».



> To start the calibration, push the button «Start/Stop».  
– When the calibration is complete, the result is shown in the display.

## Packing the Embroidery Module

To pack the embroidery module into the original packaging without moving the embroidery arm manually, the embroidery arm needs to be brought to its packing position.

Prerequisite:

- The embroidery module is connected with the machine.



> Tap «Home».



> Tap «Setup Program».



> Tap «Machine Settings».



> Tap «Maintenance/Update».



> Tap «Packing Position».  
> Follow the instructions on the display.

## 4 System Settings

### 4.1 Calling Up the Tutorial

The Tutorial gives information and explanations, covering various aspects of sewing, embroidering, and the different stitches.



- > Tap «Home».



- > Tap «Tutorial».
- > Select the desired topic in order to view information.

### 4.2 Calling Up the Creative Consultant

The Creative Consultant informs you about decision support for sewing projects. After entering the kind of fabric and the desired sewing project, suggestions concerning the suitable needle or the appropriate presser foot are displayed.



- > Tap «Home».



- > Tap «Creative Consultant».
- > Select the fabric on which you want to sew.
- > Select the sewing project.



- > Tap «Confirm».
- The settings are adjusted.

### 4.3 Using eco Mode

If work is interrupted for an extended period, the machine can be put into energy-saving mode. The power save mode eco also serves as a child safety feature. Nothing can be selected in the display and the machine cannot be started.



- > Tap «Home».



- > To activate the power save mode, tap «eco Mode».
- The display goes to sleep. The power consumption is reduced and the sewing light is off.
- > To deactivate the power save mode, tap «eco Mode» again.

### 4.4 Calling Up the Help

- > Touch the window in the display where help is needed.
- > To start the Help Mode, tap «Help» twice.
- > Tap the icon in the display where help is needed.



### 4.5 Cancelling Any Alterations with «clr»

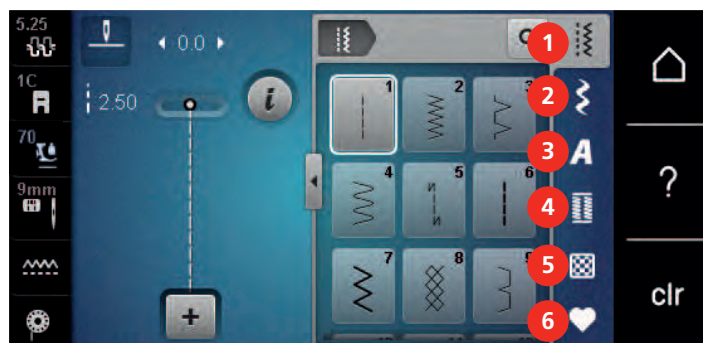
Any alterations to designs can be reset to basic setting. Exceptions are saved designs which have been filed in the personal memory and monitoring functions.



- > Tap «Clear Settings».

## 5 Creative Sewing

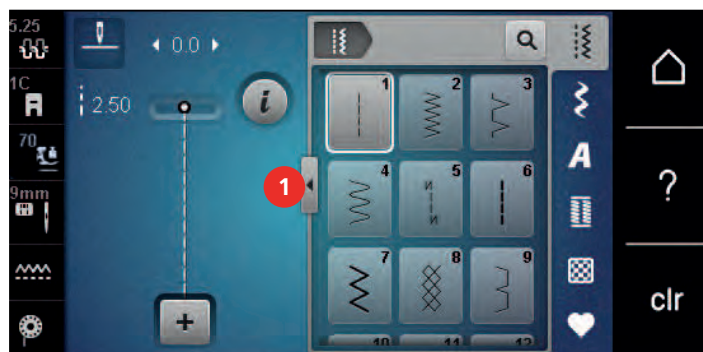
### 5.1 Overview Selection Menu Sewing



- |   |                       |   |                   |
|---|-----------------------|---|-------------------|
| 1 | «Practical Stitches»  | 4 | «Buttonholes»     |
| 2 | «Decorative Stitches» | 5 | «Quilt Stitches»  |
| 3 | «Alphabets»           | 6 | «Personal Memory» |

#### Selecting a Stitch Pattern

- > Select a stitch pattern, alphabet or buttonhole.
- > Wipe up in the area of the practical stitches, alphabets or buttonholes to have more stitch patterns displayed.
- > To increase the view, tap «Increasing/Decreasing the Display Size» (1).



- > To decrease the view, tap «Increasing/Decreasing the Display Size» again.
- > To select the stitch pattern via the stitch number entry, tap «Stitch Pattern Selection via Number».



### 5.2 BERNINA Dual Feed

The BERNINA Dual Feed feeds the fabric from above and from beneath simultaneously. This provides an even and careful feed forward even for smooth and thin materials. Striped and checkered patterns can be matched perfectly by even feeding.

In general, the BERNINA Dual Feed is used for the following sewing projects:

- Sewing: All sewing applications with difficult fabrics, e. g. seams, zippers.
- Patchwork: With accurate stripes, blocks and with decorative stitches up to a stitch width of 9 mm.
- Appliqués: Sewing on ribbons and bias binding.

Difficult-to-work-with fabrics are:

- Velvet, normally sewn with the grain.
- Toweling.
- Jersey, especially when sewing it crosswise to knit.
- Fake fur or coated fake fur.
- Fleece-types of fabrics.
- Batted fabrics.
- Stripes and checks.
- Curtain fabrics with pattern repeats.

«Sticky» fabrics are:

- Imitation leather, coated fabrics (optimally with optional accessory Zigzag Foot with Non-Stick Sole #52D).

### 5.3 Regulating the Speed

The sewing speed can be adjusted infinitely variable with the slide.

- > Move the slide to the left to reduce the sewing speed.
- > Move the slide to the right to increase the sewing speed.

### 5.4 Adjusting the Upper Thread Tension

The default setting of the upper thread tension is set automatically as soon as a stitch pattern or an embroidery design is selected.

The upper thread tension is set optimally at the BERNINA factory and the machine has been tested. Metrosene/Seralon thread size 100/2 (Mettler, Switzerland) is used for the upper and bobbin thread.

When using different types of sewing or embroidery threads, the upper thread tension may vary. Therefore it may be necessary to adjust the upper thread tension according to the sewing or embroidering project as well as the desired stitch pattern or the embroidery design individually.

The higher the upper thread tension is set, the tighter the upper thread is tensioned, and the bobbin thread is pulled deeper into the fabric. When the upper thread tension is low, the upper thread is less tightened, and the bobbin thread is pulled up less into the fabric.

Alterations of the upper thread tension affect the currently selected stitch pattern and all embroidery designs. Permanent alterations of the upper thread tension for the sewing mode (see page 53) and for the embroidering mode (see page 49) can be made in the Setup Program.

Prerequisite:

- The upper thread tension has been altered in the Setup Program.
- > Tap «Upper Thread Tension».
- > Adjust the upper thread tension.

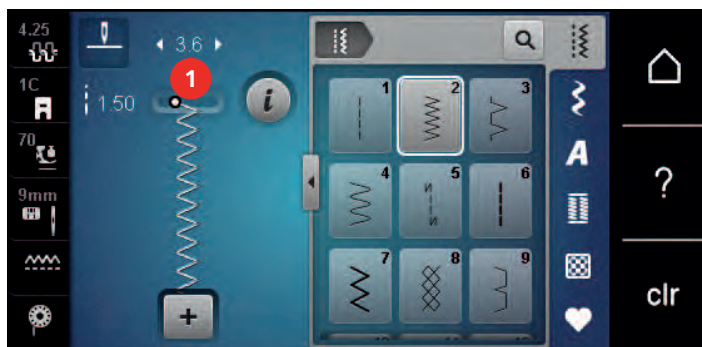


- > Tap the yellow-outlined icon on the right side to reset the alterations to the default setting.
- > Tap the yellow-outlined icon on the left side to reset the alteration to default setting in the **Setup Program**.

## 5.5 Editing Stitch Patterns

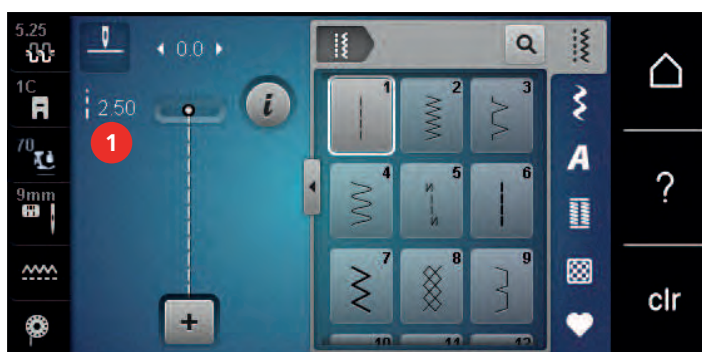
### Changing the Stitch Width

- > Turn the «Upper Multi-function Knob» to the left to narrow the stitch width.
- > Turn the «Upper Multi-function Knob» to the right to widen the stitch width.
- > To call up further setting options, tap the icon «Stitch width» (1).



### Changing the Stitch Length

- > Turn the «Lower Multi-function Knob» to the left to shorten the stitch length.
- > Turn the «Lower Multi-function Knob» to the right to elongate the stitch length.
- > To call up other setting options, tap «Stitch Length» (1).



### Correcting the Balance

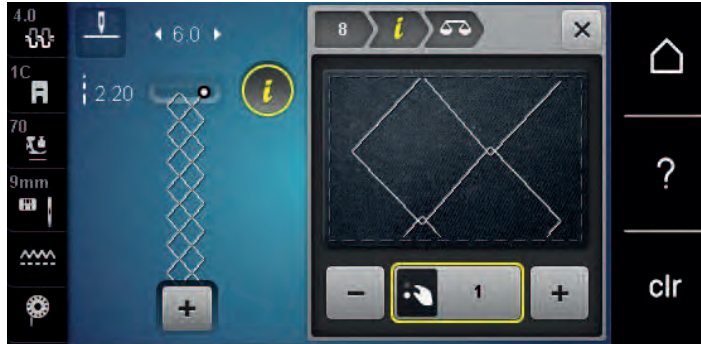
Different fabrics, threads and stabilizers can affect the programmed stitch patterns so that they cannot be sewn out correctly. The electronic balance can correct these deviation and the stitch pattern can be adjusted optimally to the selected fabric.

- > Select a stitch pattern or alphabet.
- > Sewing stitch pattern.
- > Tap «i-Dialog».





- > Tap «Balance».
- A preview of the stitch pattern is displayed.



- > To correct the longitudinal direction of the stitch pattern, turn the «Lower Multi-function Knob» until the preview of the stitch pattern matches the stitch pattern sewn on the fabric.



- > Altered Balance settings can be saved for each stitch in the «Personal Memory» .
- > Altered Balance settings only remain valid until the «Clear Settings» is pushed or the machine is switched off.

### Programming Pattern Repeat

Stitch patterns can be repeated up to 99 times.

- > Select a stitch pattern or alphabet.
- > Tap «i-Dialog».



- > Tap «Pattern Repeat».
- > Enter the required number of stitch patterns.



- > Tap «Confirm».



- > To deactivate the pattern repeat, tap and hold «Pattern Repeat».

### Mirror Image of Stitch Patterns

- > Select a stitch pattern or alphabet.
- > Tap «i-Dialog».



- > To mirror the stitch pattern from left to right, tap «Mirror Image Left/Right».



- > To mirror the stitch pattern in sewing direction, tap «Mirror Image Up/Down».

### Edit Stitch Pattern Length

The stitch patterns can be lengthwise extended or shortened.

- > Select a stitch pattern or alphabet.





> Tap «i-Dialog».



> Tap «Edit Stitch Pattern Length».  
> Adjust the stitch pattern length.

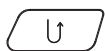
### Programming the Stitch Counter Function

The Stitch Counter function cannot be set for all stitch patterns. If, for example, the Honeycomb Stitch No. 8 is selected, the stitch counter function cannot be used.

> Select the stitch pattern.  
> Tap «i-Dialog».



> Tap «Programming the Length via the Stitch Counter».  
> Sew the desired length.

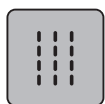


> Push the button «Quick Reverse».  
– The display changes to «Auto» and the selected stitch pattern in the new length is saved until the machine is switched off.

### Sewing Stitch Patterns Using the Triple Stitch

The stitch pattern can be sewn three times for a more attractive result. Not all stitch patterns can be sewn using the triple stitch.

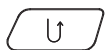
> Select the stitch pattern.  
> Tap «i-Dialog».



> Tap «Triple Stitch».

### Quick Reverse

> Select a stitch pattern or alphabet.  
> To switch immediately to sewing in reverse when pushing the button «Quick Reverse», select Needle Stop Down (permanent).  
> Program needle stop up (permanent) to sew another stitch forward before the machine switches to reverse sewing.



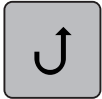
> Push and hold the button «Quick Reverse».

### Permanent Quick Reverse

> Select a stitch pattern or alphabet.  
> Tap «i-Dialog».







- > To sew permanently in reverse, tap «Quick Reverse».
  - The machine sews permanently in reverse until «Quick Reverse» is tapped again.

### Backstepping



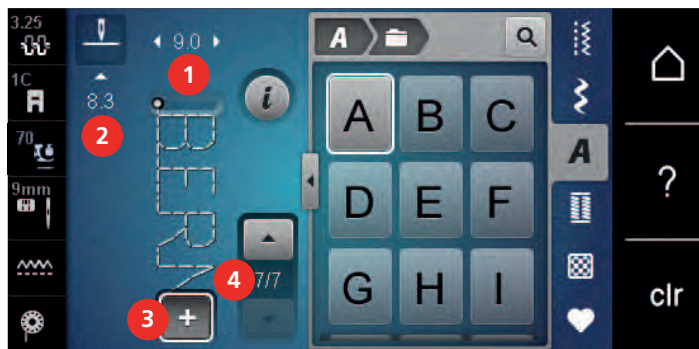
- > Select a stitch pattern or alphabet.
- > Tap «i-Dialog».



- > To backstep the last 200 stitches, tap «Backstepping».

## 5.6 Combining Stitch Patterns

### Overview Combi Mode



- |   |                 |   |  |
|---|-----------------|---|--|
| 1 | «Stitch Width»  | 3 | «Combination Mode/Single Mode»                   |
| 2 | «Stitch Length» | 4 | Individual Stitch Pattern within the Combination |

### Creating Stitch Pattern Combinations

In the Combi Mode stitch patterns and alphabets can be combined according to your wish. By combining any alphabet letters, the logo BERNINA can be created.



- > Tap «Combination Mode/Single Mode».
- > Select the desired stitch patterns.



- > To get back to the Single Mode, tap «Combination Mode/Single Mode» again.

## Saving a stitch pattern combination

To use an individually created stitch pattern combinations again, they can be saved in the folder «Personal Memory».

Prerequisite:

- A stitch pattern combination has been created.



> Tap «Personal Memory».



> Tap «Save Stitch Pattern».



> To save the stitch pattern combination, tap «Confirm».

## Loading a Stitch Pattern Combination



> Tap «Combination Mode/Single Mode».



> Tap «Personal Memory».



> Tap «Loading a Stitch Pattern Combination».

> Select a stitch pattern combination.

## Overwriting a Stitch Pattern Combination

Prerequisite:

- A stitch pattern combination has been created.



> Tap «Personal Memory».



> Tap «Save Stitch Pattern».

> Select the stitch pattern combination which is to be overwritten.



> To overwrite the stitch pattern combination, tap «Confirm».

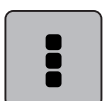
## Deleting a Stitch Pattern Combination

Prerequisite:

- A stitch pattern combination has been created.



> Tap «i-Dialog».



> Tap «Edit Entire Combination».



> Tap «Deleting».



> Tap «Confirm».

## Editing a Single Stitch Pattern

Prerequisite:

- A stitch pattern combination has been created.
- > To select a single stitch pattern, tap the desired position (1) within the stitch pattern combination.



- > To edit the single stitch pattern, tap «i-Dialog».

## Deleting a Single Stitch Pattern

Prerequisite:

- A stitch pattern combination has been created.
- > Tap the desired stitch pattern (1) within the stitch pattern combination.



- > Tap «i-Dialog».



- > Tap «Deleting».

## Adding a Single Stitch Pattern

The new stitch pattern is always inserted after the selected stitch pattern.

Prerequisite:

- A stitch pattern combination has been created.

> To select a single stitch pattern, tap the desired position (1) within the stitch pattern combination.



> Select a new stitch pattern.

### Adapting the Stitch Pattern length and Stitch Pattern Width

The length and width of the individual stitch patterns in a stitch pattern combination can be adapted to the longest and widest stitch patterns in the combination.

Prerequisite:

- A stitch pattern combination has been created.

> Tap «i-Dialog».



> Tap «Edit Entire Combination».

> Tap «Total Pattern Length» (1).



> Tap «Adjust Length within the Combination» (2).

- The lengths of the stitch patterns are adapted to the length of the longest stitch pattern in the combination.

> Tap «Stitch Width» (3).





- > Tap «Adjust Width within the Combination» (4).
  - The widths of all of the stitch patterns are adapted to the width of the widest stitch pattern in the combination.

Furthermore, the length and width of the stitch pattern combination are increased or decreased proportionally.

- > To decrease the width of the stitch pattern combination proportionally, turn the «Upper Multi-function knob» to the left.
- > To increase the width of the stitch pattern combination proportionally, turn the «Upper Multi-function knob» to the right.
- > To decrease the length of the stitch pattern combination proportionally, turn the «Lower Multi-function knob» to the left.
- > To increase the length of the stitch pattern combination proportionally, turn the «Lower Multi-function knob» to the right.

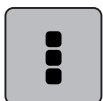
### Mirroring a Stitch Pattern Combination

Prerequisite:

- A stitch pattern combination has been created.



- > Tap «i-Dialog».



- > Tap «Edit Entire Combination».



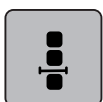
- > To mirror the whole stitch pattern combination from left to right, tap, «Mirror Image Left/Right».
- > To reset the changes and revert to the default settings, tap «Mirror Image Left/Right».

### Stitch Pattern Combination Subdivider 1

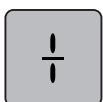
A stitch pattern combination can be subdivided into several sections. The subdivision is inserted below the cursor. Only the section in which the cursor is placed will be sewn. To sew the next section, the cursor must be placed in this section.

Prerequisite:

- A stitch pattern combination has been created.
- > Select the desired position within the stitch pattern combination where the stitch pattern combination is to be subdivided.
- > Tap «i-Dialog».



- > Tap «Edit Combination at Cursor Position».



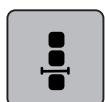
- > Tap «Combination Subdivider (1)».

## Stitch Pattern Combination Subdivider 2

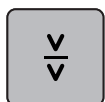
A stitch pattern combination can be interrupted at different positions. The interruption is inserted below the cursor.

Prerequisite:

- A stitch pattern combination has been created.
- > Select the desired position within the stitch pattern combination where the stitch pattern combination is to be interrupted.
- > Tap «i-Dialog».



- > Tap «Edit Combination at Cursor Position».

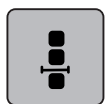


- > Tap «Combination Subdivider (2)».
- > Sew stitch pattern combination up to the interruption and reposition the fabric.

## Securing a Stitch Pattern Combination

Prerequisite:

- A stitch pattern combination has been created.
- > Select the desired position within the stitch pattern combination where the stitch pattern combination is to be secured.
- > Tap «i-Dialog».



- > Tap «Edit Combination at Cursor Position».

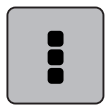


- > Tap «Securing Stitches».
  - Every single pattern of the stitch pattern combination can be secured at the start or at the end.

## Programming Pattern Repeat

Prerequisite:

- A stitch pattern combination has been created.
- > Tap «i-Dialog».



- > Tap «Edit Entire Combination».



- > To repeat the stitch pattern combination, tap «Pattern Repeat» 1x.
- > To repeat the stitch pattern combination up to 9x, tap «Pattern Repeat» again.
- > To deactivate the pattern repeat, tap and hold «Pattern Repeat» or tap «Clear Settings».

## 5.7 Administering Stitch Patterns

### Saving Settings of Stitch Patterns



- > Select a stitch pattern, alphabet or buttonhole.
- > Tap «i-Dialog».
- > Edit the stitch, alphabet or buttonhole.



- > To save all alterations permanently, tap «Saving Settings of Stitch Patterns».



- > To cancel all alterations, tap «Reset Stitch Pattern».

### Saving Stitch Patterns in Personal Memory

In the folder «Personal Memory» any stitch patterns, also those which have been individually edited, can be saved.

- > Select a stitch pattern, alphabet or buttonhole.
- > Edit the stitch pattern.
- > Tap «Personal Memory».



- > Tap «Save Stitch Pattern».
- > Select the file where the pattern is to be saved.



- > Tap «Confirm».

### Overwriting Stitch Patterns from the Personal Memory

Prerequisite:

- The stitch pattern is saved in the personal memory.
- > Select a stitch pattern, alphabet or buttonhole.
- > Edit the stitch pattern.
- > Tap «Personal Memory».



- > Tap «Save Stitch Pattern».
- > Select the file where the stitch pattern to be overwritten has been saved.
- > Select the stitch pattern which should be overwritten.



- > Tap «Confirm».

### Loading Stitch Patterns from the Personal Memory

Prerequisite:

- The stitch pattern is saved in the personal memory.
- > Tap «Personal Memory».



- > Tap «Load Embroidery Design».
- > Select the file where the stitch pattern has been saved.
- > Select the stitch pattern.

### Deleting Stitch Patterns from the Personal Memory

Prerequisite:

- The stitch pattern is saved in the personal memory.



- > Tap «Personal Memory».



- > Tap «Deleting».
- > Select the file where the stitch pattern has been saved.
- > Select the stitch pattern.



- > To delete the stitch pattern, tap «Confirm».

### Saving Stitch Patterns on the BERNINA USB Stick

On the BERNINA USB stick stitch patterns, also those which have been individually edited, can be saved.

- > Select a stitch pattern or alphabet.
- > Editing stitch patterns.
- > Tap «Personal Memory».



- > Tap «Save Stitch Pattern».
- > Insert the BERNINA USB stick into the USB port of the machine.



- > Tap «USB Stick».



- > Tap «Confirm».

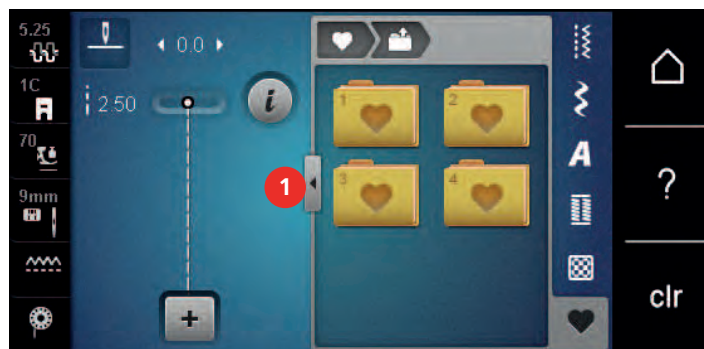
### Uploading a Stitch Pattern from the BERNINA USB Stick



- > Tap «Personal Memory».



- > Tap «Load Embroidery Design».
- > Tap «Increasing/Decreasing the Display Size» (1).



- > Insert the BERNINA USB stick into the USB port of the machine.
- > Tap «USB Stick».
- > Select the desired stitch pattern.



## Deleting Stitch Patterns from the BERNINA USB Stick



- > Tap «Personal Memory».



- > Tap «Deleting».
- > Insert the BERNINA USB stick into the USB port of the machine.
- > Select the stitch pattern which is to be deleted.



- > Tap «Confirm».

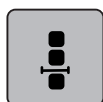
## 5.8 Securing Stitches

### Securing via the Icon «Securing»

Every single pattern of the stitch pattern combination can be secured at the start or at the end.



- > Tap «i-Dialog».



- > Tap «Edit Combination at Cursor Position».



- > Tap «Securing Stitches» before sewing is started.
  - The stitch pattern/stitch pattern combination is secured with 4 stitches at the beginning.
- > Tap «Securing Stitches» while sewing.
  - The stitch pattern or the active stitch pattern of the stitch pattern combination is secured with 4 stitches at the end.

### Securing with the Button «Pattern End»

The «Pattern End» button can be programmed with various securing stitches.

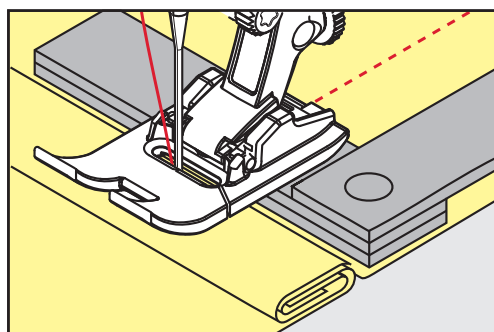


- > Push the button «Pattern End» before sewing is started or while sewing.
  - While sewing, a stop icon indicates that the function is activated and the stitch pattern or the current combination of a stitch pattern will be secured at the end with the programmed number of stitches.

## 5.9 Height Compensation of Uneven Layers

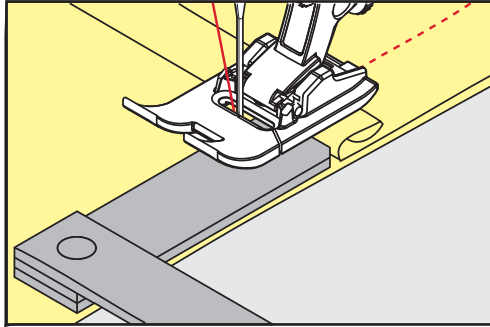
If the presser foot is at an angle when sewing over a thick seam, the feed dog cannot grip the fabric and the sewing project cannot be sewn out properly.

- > Place 1 – 3 compensating plates as required from the back of the presser foot close to the needle to level the fabric layer.



- The presser foot is leveled with the sewing project.

- > Place 1 – 3 compensating plates as required from the front of the presser foot close to the needle to level the fabric layer.

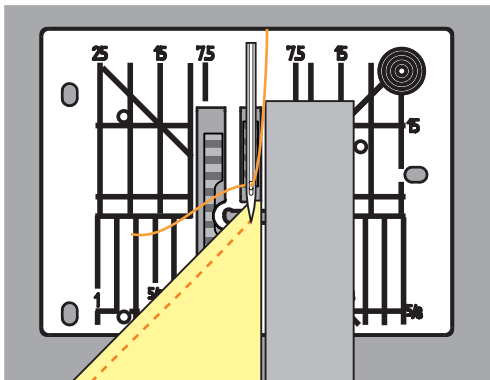


- The presser foot is leveled with the sewing project.
- > Sew until the complete presser foot has passed the thick seam.
- > Remove the plates of the height compensation.

### 5.10 Sewing Corners

When sewing corners, only a small section of the fabric is actually on the feed dog. Therefore it cannot grip the fabric well. By means of the height compensation tool the fabric can be fed evenly.

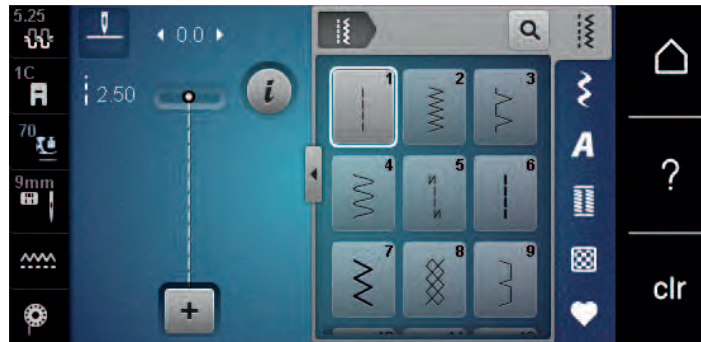
- > When the fabric edge is reached, stop the sewing process with needle position down.
- > Raise the presser foot.
- > Turn the fabric and place in desired position.
- > Place 1 – 3 compensating plates as required on the right of the presser foot close to the sewing project.
- > Lower the presser foot.

















- > Resume sewing until the sewing project is on the feed dog again.










## 6 Practical Stitches

### 6.1 Overview Practical Stitches

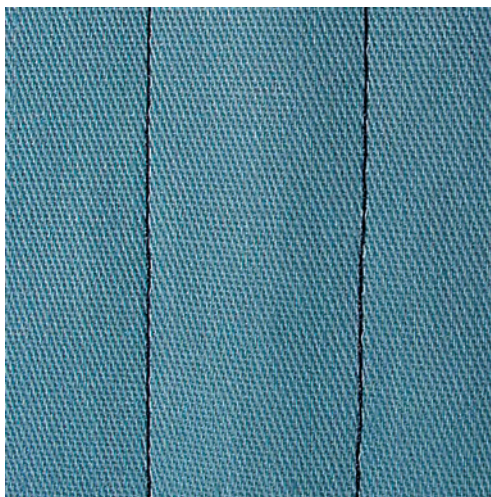


Stitch patterns	Stitch number	Name	Description
---	1	Straight Stitch	To join seams, for topstitching and basting.
W	2	Zigzag	To finish edges, to sew elastic seams, to sew on lace inserts and elastics.
VV	3	Vari-Overlock	For finishing edges, sewing together and simultaneously finishing elastic fabrics.
W	4	Running Stitch	For darning and reinforcing fabric edges or attaching lace or rubber tape.
N S	5	Securing Program	For automatic securing at the start of the seam with forward and reverse stitches.
---	6	Triple Straight Stitch	For reinforced seams on heavy fabrics and decorative effects.
W	7	Triple Zig zag	For durable seams on strong fabrics, visible hems and decorative seams.
X	8	Honeycomb Stitch	For stretch fabrics and hems, including with rubber threads.
W	9	Blind Stitch	For blind hems on most fabric types and for shell edging on soft jerseys and fine fabric.
W	10	Double Overlock	For simultaneously sewing together and finishing elastic fabrics.
W	11	Superstretch Stitch	For highly stretch open seams.

	12	Gathering Stitch	For gathering with rubber threads and for flat joining seams on medium-weight fabrics.
	13	Stretch Overlock	For simultaneously sewing together and finishing elastic fabrics, as well as for flat joining seams.
	14	Tricot Stitch	For visible hems and seams in lingerie and sweaters and for mending tricot fabric.
	15	Universal Stitch	For flat joining seams, visible hems and decorative seams in strong fabrics such as felt and leather and for attaching rubber tape.
	16	Sewn-out Zigzag	For finishing and reinforcing fabric edges, for sewing on rubber tape and for decorative seams.
	17	Lycra Stitch	For flat joining seams, visible hems on Lycra fabric and for stitching over seams in foundation garments.
	18	Stretch Stitch	For stretchable seams and hems in woven and knitted fabrics.
	19	Reinforced Overlock	For overlock seams or flat joining seams on medium-weight knit fabrics and toweling.
	20	Knit Overlock	For stretchable seams and hems in woven and knitted fabric, for sewing and finishing.
	22	Simple Darning Program	For automatic darning in fine to strong fabrics.
	23	Reinforced Darning Program	For automatic darning in strong materials.
	24	Bartack Program	For reinforcing pocket openings, buttonhole bars and for sewing belt loops.
	25	Bartack Program	For reinforcing pocket openings, sewing belt loops and securing seam ends.
	26	Large Fly Stitch	For reinforcing pocket openings, zippers and slits in medium-weight to thick fabrics.

	27	Small Fly Stitch	For reinforcing pocket openings, zippers and slits in fine to medium-weight fabrics.
	29	Narrow Blind Stitch	For blind hems and shell edging in light, fine and soft fabrics.
	30	Manual Basting Stitch	For work where a very long stitch length is required.
	32	Single Straight Stitch	As a connecting stitch in a combination for one straight stitch.
	33	Three Single Straight Stitches	As connecting stitches in a combination for three individual straight stitches.
	34	Darning Stitch	For darning together with the function "Permanent reverse sewing".
	35	Open Overlock Stitch	For simultaneously sewing together and finishing elastic fabrics with a reinforced edge.
	36	Overlock	For medium-weight knitted goods.
	37	Reinforced Overlock Stitch	For simultaneously sewing together, finishing and reinforcing elastic fabrics.

## 6.2 Sewing Straight Stitch



Adjust the stitch length for the sewing project, e.g. a long stitch for denim (approx. 3 – 4 mm) and a short stitch for delicate fabric (approx. 2 – 2.5 mm). Adjust the stitch length depending on the thread thickness, e.g. a long stitch (approx. 3 – 5 mm) for top-stitching with gimp.

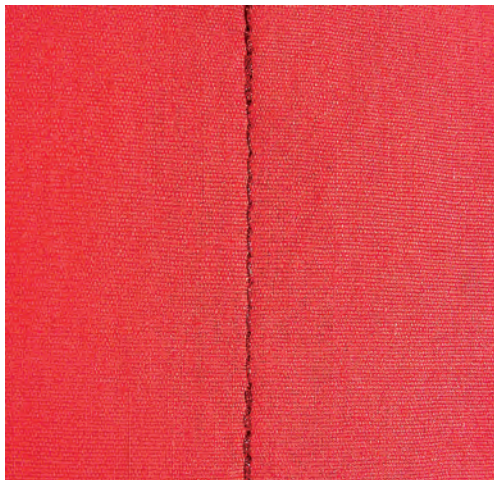
Prerequisite:

- The Reverse Pattern Foot #1C/1D is fitted.



- > Tap «Practical Stitches».
- > Select Straight Stitch No. 1.

### 6.3 Securing with the Automatic Securing Program



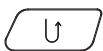
Due to a determined number of 6 stitches sewn forwards and 6 stitches sewn in reverse, the securing is regular.

Prerequisite:

- The Reverse Pattern Foot #1C is fitted.

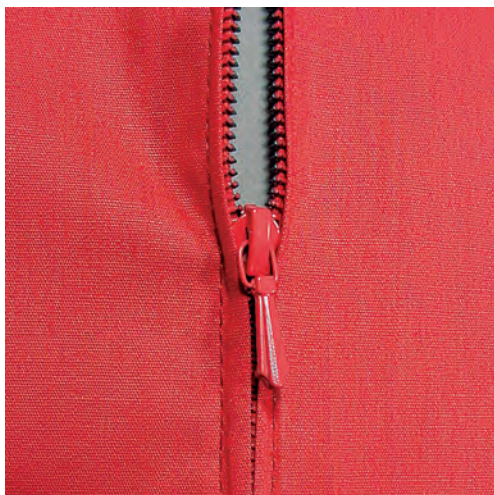


- > Tap «Practical Stitches».
- > Select Securing Program No. 5.
- > Press the foot control.
  - The machine secures automatically.



- > Sew the seam at the desired length.
- > Push the button «Quick Reverse».
  - The machine secures automatically and stops at the end of the securing program.

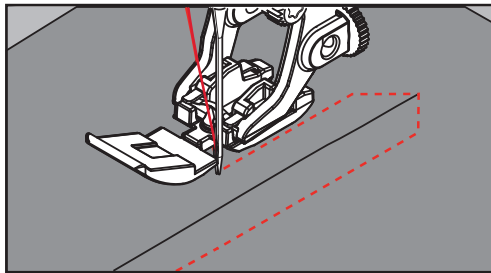
### 6.4 Sewing in the Zipper



As the fabric feed can be difficult when starting to sew, it is recommended to hold the threads firmly or to pull the fabric slightly to the back for a few stitches or to sew 1 – 2 cm reverse first.



- > Fit the Reverse Pattern Foot #1C.
- > Tap «Practical Stitches».
- > Select Straight Stitch No. 1.
- > Sew the seam up to where the zipper starts.
- > Sew the securing stitches.
- > Close the zipper length with long stitches.
- > Finish the seam allowances.
- > Iron the seam.
- > Open the zipper length.
- > Baste the zipper under the fabric so that the fabric folded edges meet over the center of the zipper.
- > Open the zipper a few centimeters.
- > Fit the Zipper Foot #4D.
- > Move the needle position to the right.
- > Use the Free Hand System to raise the presser foot and to position the sewing project.
- > Start sewing from top left.
- > Guide the foot so that the needle stitches along the zipper coils.
- > Stop in front of the zipper pull with needle position down.
- > Raise the presser foot.
- > Close the zipper.
- > Continue to sew and stop in front of the base of the zipper with needle position down.
- > Raise the presser foot and turn the sewing project.
- > Sew across the other side of the zipper and stop with needle position down.
- > Raise the presser foot and turn the sewing project.
- > Sew the second side from bottom to top.



## 6.5 Sewing Both Sides of the Zipper from Bottom to Top

For fabrics with pile, such as velvet, it is recommended to sew in the zipper on both sides from bottom to top.



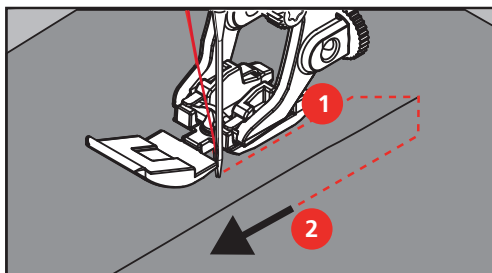
When the fabric is firm or densely woven, it is recommended to use a needle with the size 90 – 100. This results in an even stitch formation.



- > Fit the Reverse Pattern Foot #1C.
- > Tap «Practical Stitches».
- > Select Straight Stitch No. 1.
- > Sew the seam up to where the zipper starts.
- > Sew the securing stitches.
- > Close the zipper length with long stitches.
- > Finish the seam allowances.
- > Iron the seam.
- > Open the zipper length.
- > Baste the zipper under the fabric so that the fabric folded edges meet over the center of the zipper.
- > Fit the Zipper Foot #4D.
- > Move the needle position to the right.



- > Use the Free Hand System to raise the presser foot and to position the sewing project.
- > Start sewing in the center of the seam at the end of the zipper.
- > Sew diagonally along the edge of the zipper coils.
- > Sew the first side (1) from bottom to top.
- > Stop in front of the zipper pull with needle position down.
- > Raise the presser foot.
- > Open the zipper as far as behind the presser foot.
- > Lower the presser foot and continue sewing.
- > Move the needle position to the left.
- > Sew the second side (2) in exactly the same way from bottom to top.



## 6.6 Sewing Triple Straight Stitch



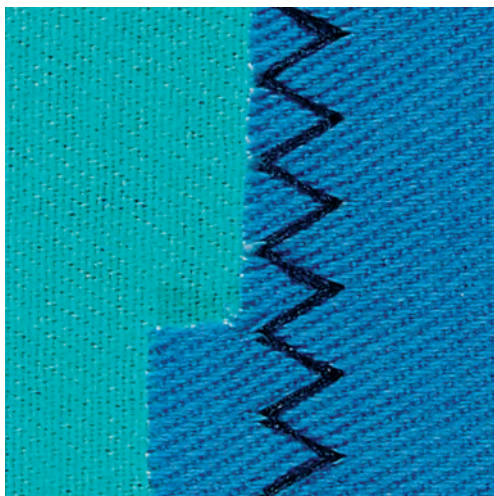
The triple straight stitch is especially suitable for durable seams and for firm, densely woven fabrics such as denim and corduroy. For firm or densely woven materials, it is recommended to fit the Jeans Foot #8. This will help to sew denim or canvas. For decorative topstitching, the stitch length can be elongated.

- > Fit the Reverse Pattern Foot #1C/1D.
- > Tap «Practical Stitches».
- > Select Triple Straight Stitch No. 6.





## 6.7 Sewing Triple Zigzag

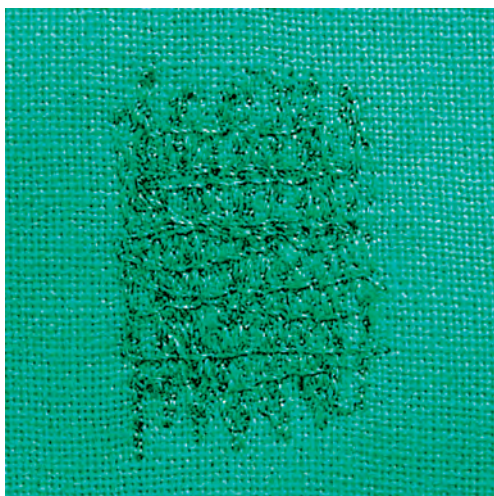


In firm fabrics, particularly for denim fabrics, deckchair covers, awnings. Hems on items that are frequently washed. Finish the seam edges first.

- > Fit the Reverse Pattern Foot #1C/1D.
- > Tap «Practical Stitches».
- > Select Triple Zig zag No. 7.



## 6.8 Manual Darning



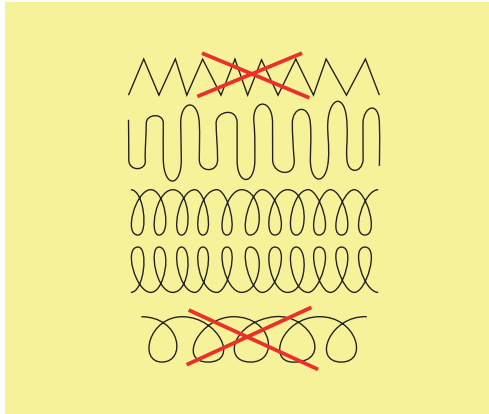
Used for darning holes or worn areas in all fabric types.

If the thread is lying on top and a poor stitch formation results, slow down the movement of the sewing project. If there are knots on the wrong side of the fabric, move the sewing project faster. When the thread breaks, guide the sewing project more consistently.

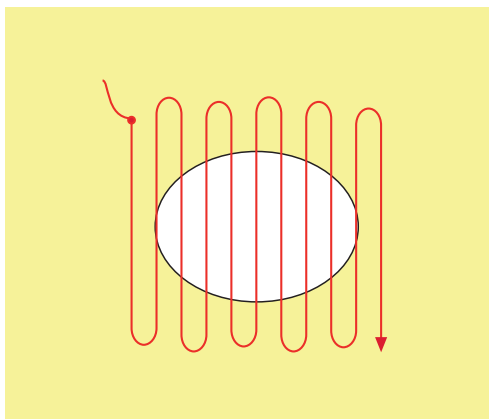
- > Fit the Darning Foot #9.
- > Tap «Practical Stitches».
- > Select Straight Stitch No. 1.
- > Lower the feed dog.
- > Attach the Slide-on Freearm Extension Table.
- > Hoop the sewing project in the round embroidery hoop (optional accessory).
  - The darning area stays evenly taut and cannot be distorted.
- > Sew from the left to the right, guide the fabric evenly by hand without using pressure.



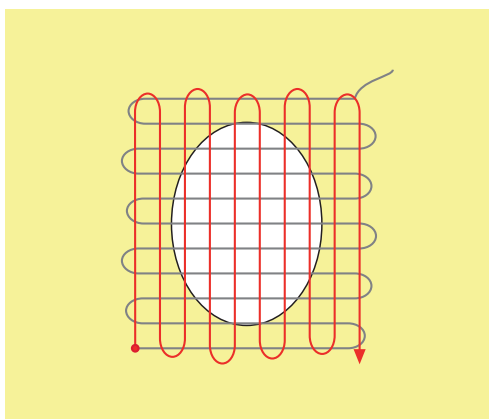
- > Move in curves when changing the direction to avoid holes and thread breakage.
- > Work the edges in irregular lengths so that the thread is better spread over the fabric.



- > Sew the first rows not too close together and beyond the worn area.
- > Sew the rows in irregular lengths.



- > Turn the sewing project by 90°.
- > Sew the first rows not too close.



- > Turn the sewing project by 180°.



## 6.10 Reinforced Darning, Automatic



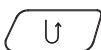
The Reinforced Darning Program No. 23 is particularly suitable for quick darning of worn areas or tears. The Reinforced Darning Program No. 23 replaces the longitudinal threads in all fabrics.



If the Darning Program does not cover the whole worn or damaged area, it is recommended to reposition the work and sew the Darning Program again. The length is programmed and can be repeated as often as desired.

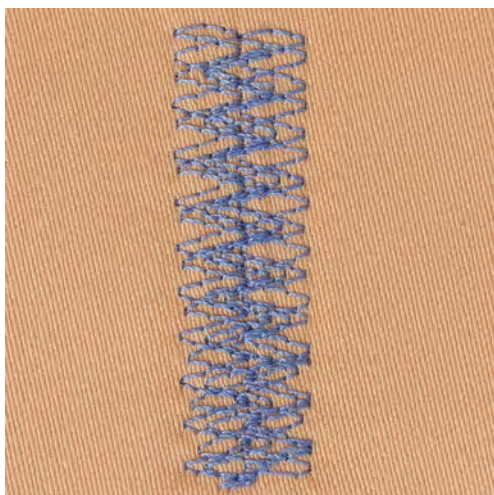


- > Fit the Buttonhole Foot with Slide #3A.
- > Tap «Practical Stitches».
- > Select Reinforced Darning Program No. 23.
- > Hoop light-weight materials in the round embroidery hoop (optional accessory).
  - The darning area stays evenly taut and cannot be distorted.
- > Start sewing top left.
- > Sew the first row.
- > Stop the machine.



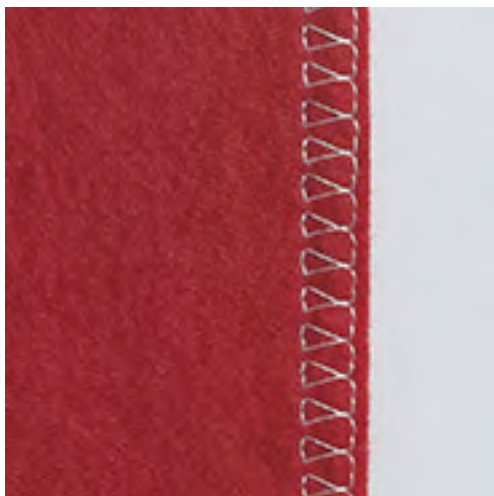
- > Push the button «Quick Reverse».
  - The darning length is programmed.
- > Finish sewing the Darning Program.
  - The machine stops automatically.

## 6.11 Reinforced Darning





### 6.13 Sewing Double Overlock



A double overlock seam is suitable for loose knits and cross seams in knits. When working with jersey, a jersey needle should be used to prevent damaging the knit fabric. When sewing stretch materials, use a stretch needle.

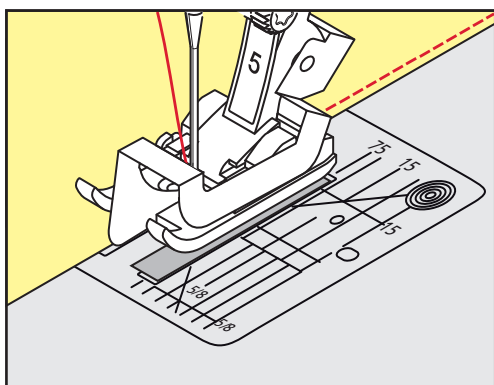


- > Fit the Reverse Pattern Foot #1C or Overlock Foot #2A.
- > Tap «Practical Stitches».
- > Select Double Overlock No. 10.

### 6.14 Narrow Edgestitching



- > Fit the Blindstitch Foot #5 or Edgestitch Foot #10/10C/10D.
- > Tap «Practical Stitches».
- > Select Straight Stitch No. 1.
- > Place the edge against the left-hand guide of the Blindstitch Foot.
- > Select the left-hand needle position at the desired distance to the edge.



### 6.15 Wide Edgestitching

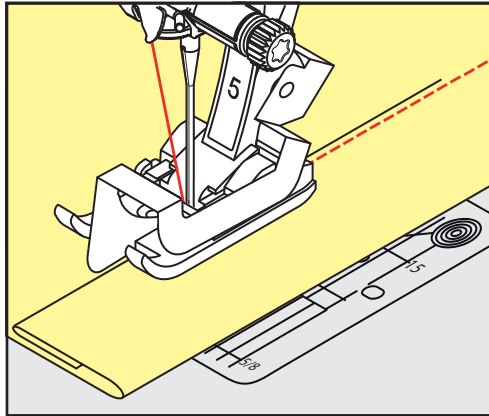


- > Fit the Reverse Pattern Foot #1C.
- > Tap «Practical Stitches».
- > Select Straight Stitch No. 1.
- > Guide the edge along the presser foot or at a distance of 1 – 2.5 cm along the marks on the stitch plate.

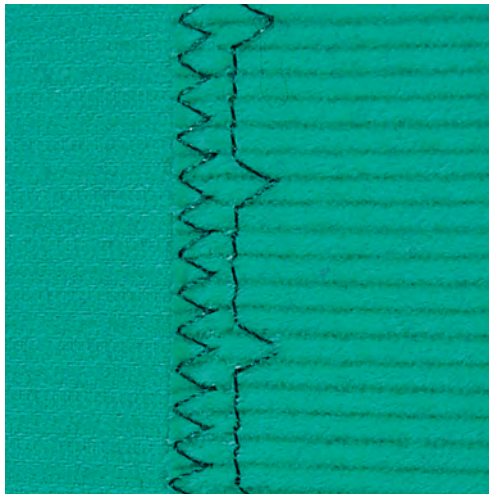




- > Select the needle position to the far right in order to sew along the upper edge.



## 6.18 Sewing Blind Hems



For invisible hems in medium to heavy weight cotton, wool and blended materials.

Prerequisite:

- The fabric edges are finished.

> Fit the Blindstitch Foot #5.

> Tap «Practical Stitches».

> Select Blind Stitch No. 9.

> Fold the fabric so that the finished fabric edge is on the right side.

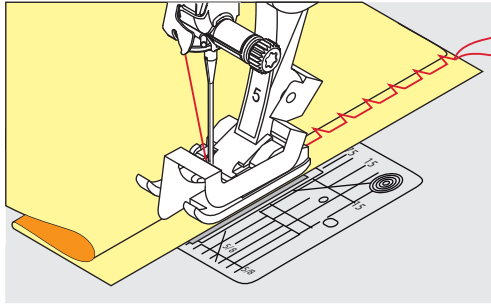
> Place the fabric under the presser foot and move the folded edge against the metal guide on the presser foot.

> Guide the folded edge evenly along the metal guide of the presser foot to sew the stitches evenly deep.  
– Make sure that the needle only pierces the edge of the fold.

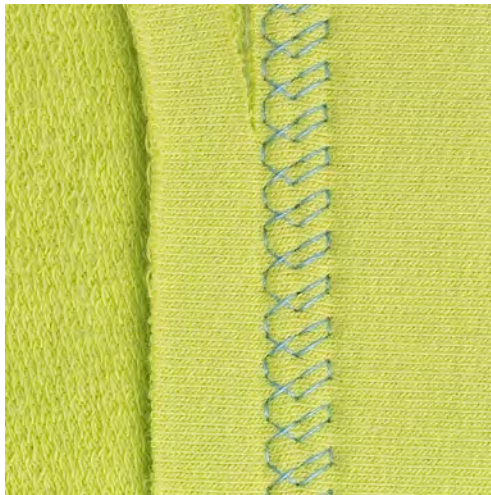




- > After sewing about 10 cm, check both sides of the fabric and adjust the width again if necessary.



## 6.19 Sewing Visible Hems

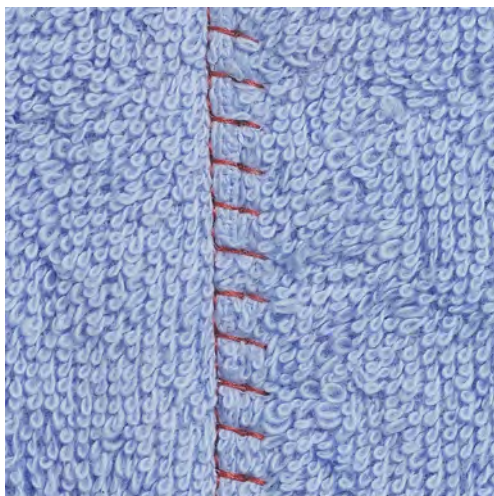


The visible hem is particularly suitable for elastic seams in tricot made of cotton, wool, synthetic and mixed fibers.



- > Fit the Reverse Pattern Foot #1C/1D.
- > Tap «Practical Stitches».
- > Select Tricot Stitch No. 14.
- > Iron the hem and baste if necessary.
- > Reduce the presser foot pressure if necessary.
- > Sew the hem in the desired depth on the right side of the fabric.
- > Trim off the remaining fabric on the wrong side of the fabric.

## 6.20 Sewing Flat Joining Seams

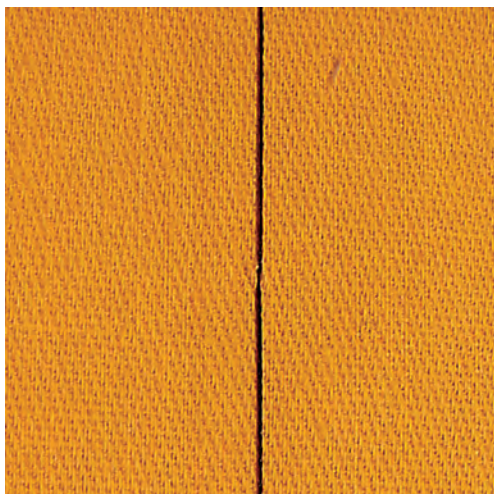


The flat joining seam is especially suitable for long-pile or thick materials such as terrycloth, felt or leather.



- > Fit the Reverse Pattern Foot #1C.
- > Tap «Practical Stitches».
- > Select Stretch Overlock No. 13.
- > Overlap the fabric edges.
- > Sew along the fabric edge.
- > To get a very flat, durable seam, make sure the needle stitches right over the top edge of the fabric into the bottom fabric.

## 6.21 Sewing Basting Stitches



When sewing basting stitches, it is recommended to use a fine darning thread. This is easier to remove. The basting stitch is suitable for sewing projects where a very long stitch length is required.



- > Fit the Darning Foot #9 (optional accessory).
- > Lower the feed dog.
- > Tap «Practical Stitches».
- > Select Manual Basting Stitch No. 30.
- > Pin the fabric layers at a right angle to basting direction to prevent the layers from slipping.
- > Hold the threads and sew 3 – 4 securing stitches at the beginning.
- > Sew a stitch and pull the fabric back at the desired stitch length.
- > Sew a stitch.
- > At the end sew 3 – 4 securing stitches.

## 7 Decorative Stitches











### 7.1 Overview Decorative Stitches

Easier or more difficult decorative stitches come into their own depending on the type of fabric.

- Decorative stitches which are programmed with simple straight stitches are particularly appropriate for lightweight materials, e. g. Decorative Stitch No. 101.
- Decorative stitches which are programmed with triple straight stitches or with a few satin stitches are particularly appropriate for medium-weight materials, e. g. Decorative Stitch No. 107.
- Decorative stitches which are programmed with satin stitches are particularly appropriate for heavyweight materials, e. g. Decorative Stitch No. 401.

For a perfect stitch formation, it is of advantage to use the same thread color for upper and bobbin thread and a stabilizer. With pile or longfiber materials, it is recommended to use an additional water-soluble stabilizer, which can be easily removed after sewing, on the right side of the fabric.



Decorative stitch	Category	Name
	Category 100	Nature stitches
	Category 300	Cross stitches
	Category 400	Satin stitches
	Category 600	Geometric stitches
	Category 700	Heirloom stitches
	Category 900	Children stitches
	Category 1100	Special stitches
	Category 1700	International
	Category 2000	Seasons
	Category 7100	Kaffe Fassett Stitches

## 7.2 Bobbin-Play



The bobbin can be filled with different thread material. For free-motion stitching to add texture. This method is similar to "normal" free-motion sewing, but is done on the **wrong** side of the fabric.

Reinforce the area to be sewn with embroidery stabilizer. The design can be drawn on the wrong side of the fabric. You can also draw the design on the front side of the fabric. The lines can be followed with a freely guided straight stitch using polyester, cotton or rayon thread. The rows of stitching are visible on the wrong side of the fabric, and they serve as guidelines for the bobbin-thread sewing.

The BSR function can be used for bobbin-thread sewing. We recommend guiding your project evenly under the needle at a consistent speed, following the lines of the design. The stabilizer must be removed after sewing.

Sew a sample first to check what the result looks like on the wrong side of the fabric.

Not all decorative stitches are suitable for this technique. Simple decorative stitches provide best results. Avoid compact stitch types and satin stitches.

### NOTICE

#### Inappropriate Bobbin Case is Used

Damage to the bobbin case.

> Use the bobbinwork bobbin case (optional accessory).



> Fit the Open Embroidery Foot #20C/20D.

> Tap «Decorative Stitches».

> Select an appropriate decorative stitch.






> Turn the «Upper Multifunction Knob» and the «Lower Multi-function Knob» to set the stitch length and stitch width so that a beautiful stitch formation can be achieved even when sewing with thick thread.



> To adjust the upper thread tension, tap «Upper Thread Tension».



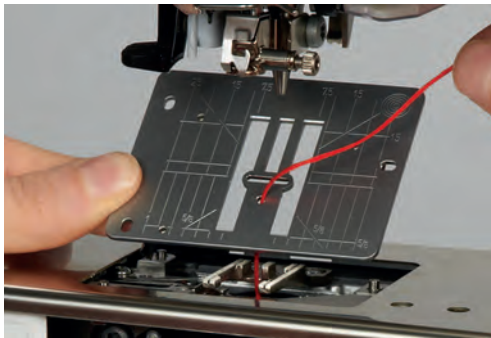
## Overview Pintuck Feet

Pintuck Foot	Number	Description
	# 30 (optional accessory)	3 grooves For heavy-weight fabrics. In combination with the 4 mm twin needle
	# 31 (optional accessory)	5 grooves For heavy to medium-weight fabrics. In combination with the 3 mm twin needle
	# 32 (optional accessory)	7 grooves For light to medium-weight fabrics. In combination with the 2 mm twin needle
	# 33 (optional accessory)	9 grooves For very light fabrics (without extra cord). In combination with the 1 or 1.6 mm twin needle
	# 46C (optional accessory)	5 grooves In combination with the 1.6 – 2.5 mm twin needle For very light to medium-weight fabrics.

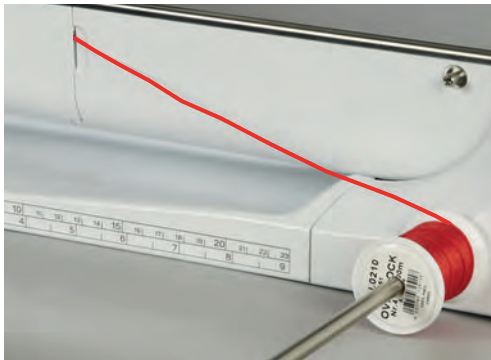
## Working with Cord

The pintucks look more distinctive and relief-like when they are sewn with a supplementary cord. Choose a cord that fits well into the grooves of the respective foot. The cord must be colorfast and shrink-proof.

- > Switch off the machine.
- > Remove the needle.
- > Remove the presser foot.
- > Remove the stitch plate.
- > Open the hook cover.
- > Pull the cord through the hook opening from the bottom and through the opening of the stitch plate.
- > Replace the stitch plate.
- > Close the hook cover.
- > Make sure that the cord slides through the thread slot of the bobbin cover.



- > Place the spool on the knee lifter.



- > Check that the cord runs smoothly.
- > If the thread doesn't glide smoothly at the hook cover, leave the hook cover open.
- > If the hook cover is opened, deactivate the lower thread indicator in the Setup Program.
  - The cord lies on the wrong side of the material and is hold/sewn over by the bobbin thread.

### Sewing Pintucks

- > Insert the corresponding twin needle.
- > Threading the double needle.
- > Thread-up command.
- > Sewing the first pintuck.
- > Place the first pintuck in one of the side grooves in the presser foot.
- > Sew additional pintucks parallel.



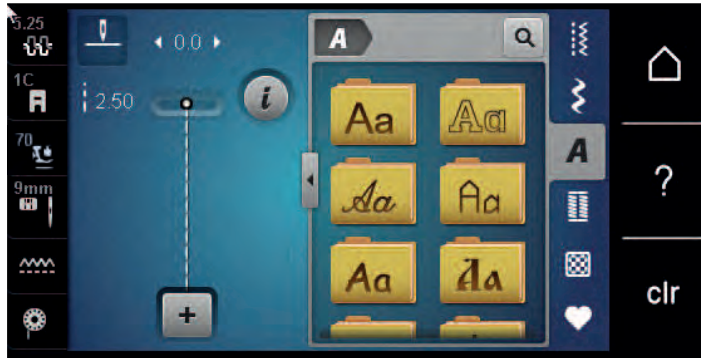


## 8 Alphabets

### 8.1 Overview Alphabet

Block- outline, script, quilt and comic writing, as well as Cyrillic and Cyrillic script can be sewn in two different sizes. Block- outline, script, quilt and comic writing, as well as Cyrillic and Cyrillic script can also be sewn in small letters.

For a perfect stitch formation, it is recommended to use the same thread color for upper and bobbin threads. The fabric can be reinforced with embroidery stabilizer on the wrong side. When working with pile or napped fabrics, e.g. toweling, use an additional, water-soluble stabilizer on the right side of the fabric.



Stitch Pattern	Name
ABCabc	Block alphabet
ABCabc	Double-Block
<i>ABCabc</i>	Script (Italics)
ABCabc	Quilt Text
ABCabc	Comic
АБВабв	Cyrillic
<i>АБВ абв</i>	Cyrillic script
あいう	Hiragana

### 8.2 Creating Lettering



It is recommend to sew a test sample using the desired thread, the original fabric and the original stabilizer. Please make sure that the fabric is fed evenly and lightly without colloding and being caught. Do not pull, push or hold the fabric while sewing.



- > Tap «Alphabets».
- > Select the font.



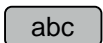
- > To create a combination, tap «Combination Mode/Single Mode».
- > To open the extended Enter Mode, tap «Increasing/Decreasing the Display Size» (1).



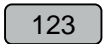
- > Select the letters.



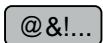
- > To use upper-case letters, tap «Upper Case Characters» (standard setting).



- > To use lower-case letters, tap «Lower Case Characters».



- > To use figures and mathematical symbols, tap «Numbers and Mathematical Characters».



- > To use special characters, tap «Special Characters».



- > To delete individual syllables of the entered text, tap «Deleting».
- > To close the extended Enter Mode, tap «Increasing/Decreasing the Display Size» again.

### 8.3 Alter Font Size

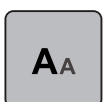
Block- outline, script, quilt and comic writing, as well as Cyrillic and Cyrillic script can be scaled down in single mode.



- > Tap «Alphabets».
- > Select the font.
- > Select the letters.



- > Tap «i-Dialog».

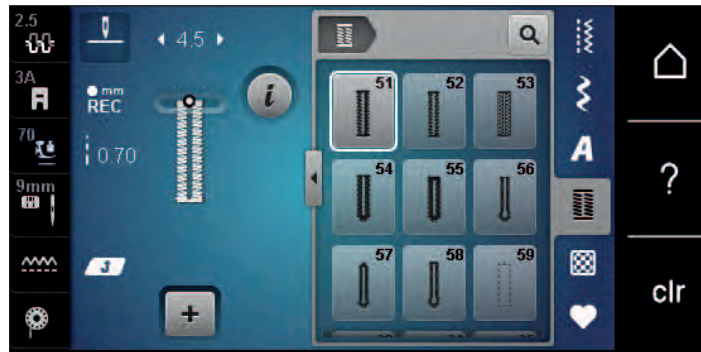











- > To reduce the font size, tap «Alter Font Size».
- > To scale up the font size to 9 mm, tap «Alter Font Size» again.









## 9 Buttonholes

### 9.1 Overview Buttonholes

To be able to create the right buttonhole for every button, every purpose and also for every garment, the BERNINA 570 QE comes with an extensive collection of buttonholes. The corresponding button can be sewn on automatically. Eyelets can also be sewn.



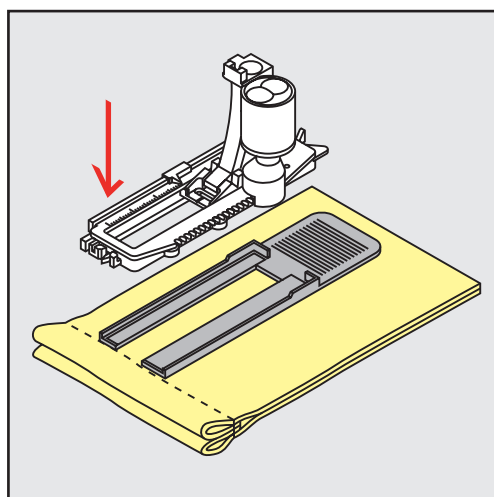
Stitch patterns	Stitch number	Name	Description
	51	Standard Buttonhole	For light to medium-weight fabrics. e.g. blouses, dresses and bed linen.
	52	Narrow Standard Buttonhole	For light to medium-weight fabrics, e.g. blouses, dresses, children's and baby clothes, crafts.
	53	Stretch Buttonhole	For all elastic fabrics.
	54	Round Buttonhole with Normal Bartack	For medium-weight to heavy fabrics. e.g. dresses, jackets, coats and rainwear.
	55	Round Buttonhole with Horizontal Bartack	For medium-weight to heavy fabrics, with a reinforced bar, e.g. dresses, jackets, coats and rainwear.
	56	Keyhole Buttonhole	For heavy, non-stretch fabrics, e.g. jackets, coats and leisurewear.
	57	Keyhole Buttonhole with Pointed Bartack	For stronger, non-stretch fabrics, e.g. jackets, coats, jeans and leisurewear.
	58	Keyhole Buttonhole with Horizontal Bartack	For strong, non-stretch fabrics, e.g. jackets, coats and leisurewear.
	59	Straight Stitch Buttonhole	For staystitching and reinforcing buttonholes and as button hole edging, especially for buttonholes in leather and imitation leather.

	60	Button Sew-on Program	Sews buttons with 2 or 4 holes.
	61	Eyelet with Small Zigzag	Openings for cords or narrow ribbons and for decorative work.
	62	Eyelet with Straight Stitch	Openings for cords or narrow ribbons and for decorative work.
	63	Heirloom Buttonhole	For handlook stitching effects on clothes and handicrafts on light to medium-weight fabrics.
	64	Double-rounded Buttonhole	For medium-weight to heavy fabrics made from different fabrics.
	65	Double-rounded Heirloom Buttonhole	For light to medium-weight woven fabrics, e.g. blouses, dresses and bedlinen.
	67	Round Buttonhole with Bartack	For medium-weight woven fabrics, e.g. blouses, dresses and jackets.
	69	Decorative Buttonhole with Double Pointed Bartack	For decorative buttonholes in firmer, non-elastic fabrics.

## 9.2 Making Use of the Height Compensation Tool

When a buttonhole is to be sewn at right angles to the project edge, it is recommend to use the height compensation plates (optional accessory).

- > Place the plates from the back between the sewing project and the bottom of the slide to the thick part of the sewing project.

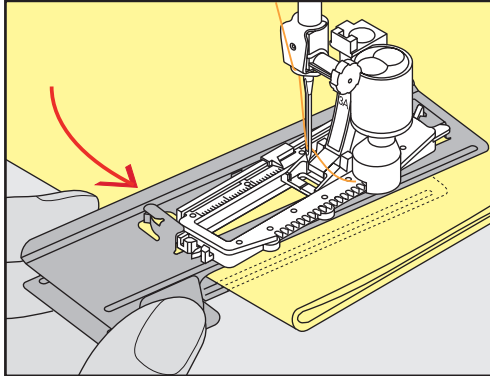


- > Lower the presser foot.

## 9.3 Using the Compensation Plate

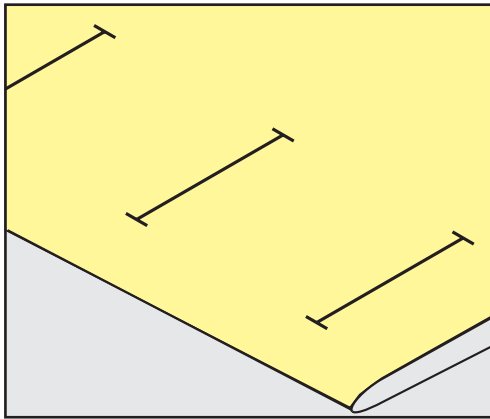
For sewing a buttonhole in problematic fabrics, it is recommended to use the Height Compensation Tool (optional accessory). The Height Compensation Tool can be used in combination with the Buttonhole Foot with Slide #3A.

- > Insert the compensation plate carefully from the side.

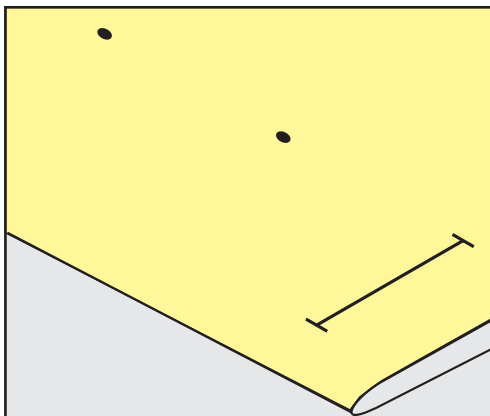


#### 9.4 Marking Buttonholes

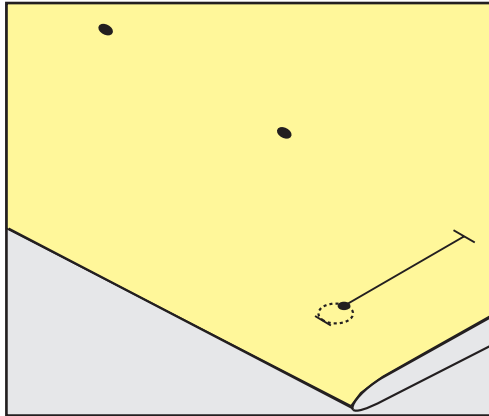
- > For the buttonholes to be sewn manually, mark the position and the length on the fabric using chalk or a water-soluble pen.



- > For the buttonholes to be sewn automatically, mark the complete length of 1 buttonhole on the fabric using chalk or a water-soluble pen. For any subsequent buttonholes mark the starting point.



- > For keyhole and round buttonholes mark the length of the bead with chalk or a water-soluble pen on the fabric. For any subsequent buttonholes mark the starting point. The length of the keyhole is sewn additionally.



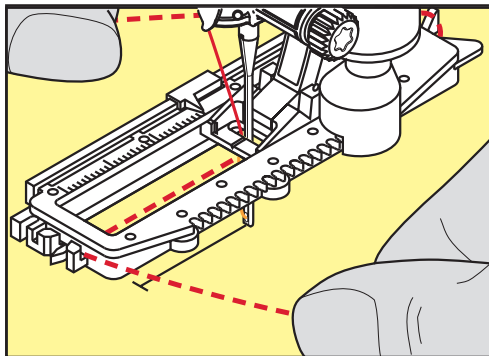
## 9.5 Cord

### Using Cord with the Buttonhole Foot with Slide #3A

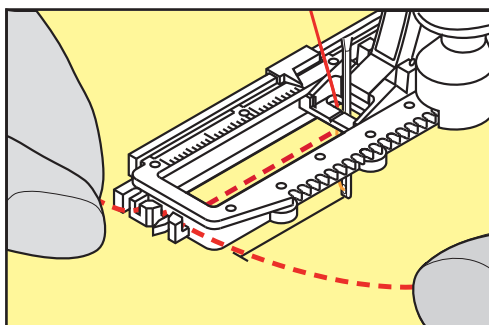
The additional cord reinforces and embellishes the buttonhole and is particularly suitable for the Buttonhole No. 51. Ideal cords are Perle cotton No. 8, strong hand-sewing thread and fine crochet yarn. It is recommended to not hold the cord while sewing.

Prerequisite:

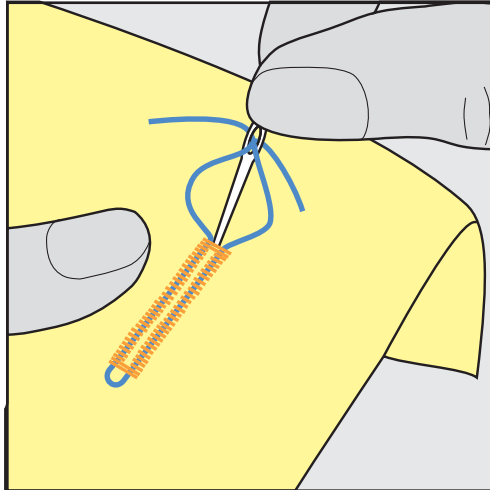
- The Buttonhole Foot with Slide #3A is fitted and raised.
- > Insert the needle at the beginning of the buttonhole.
- > Guide the cord on the right side under the Buttonhole Foot with Slide.
- > Hook the cord over the pin at the back of the Buttonhole Foot with Slide.



- > Pull the cord on the left side under the Buttonhole Foot with Slide to the front.



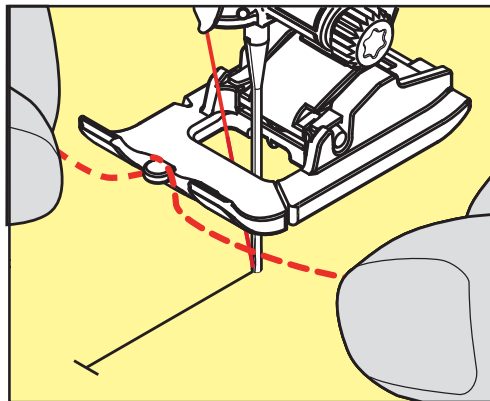
- > Pull the cord ends into the slits.
- > Lower the Buttonhole Foot with Slide.
- > Sew the buttonhole in the usual manner.
- > Pull the cord loop until the loop disappears in the bartack.
- > Pull the ends of the cord through to the wrong side of the fabric (using a hand sewing needle) and knot or secure them with stitches.



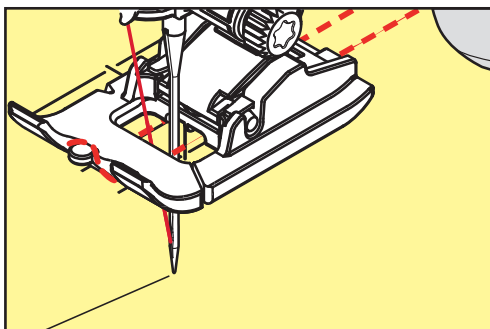
### Using cord with the Buttonhole Foot #3C

Prerequisite:

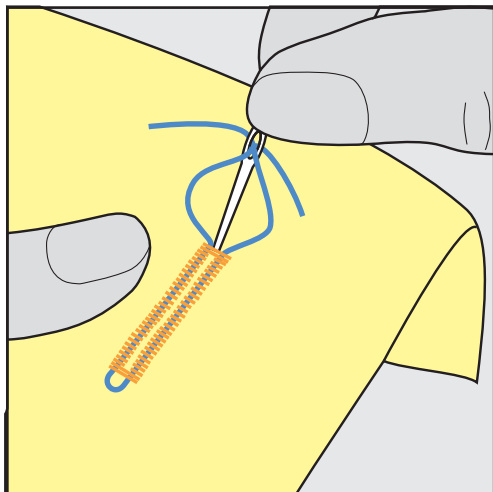
- The Buttonhole Foot #3C is fitted and raised.
- > Insert the needle at the beginning of the buttonhole.
- > Hook the cord over the center pin at the front of the Buttonhole Foot.



- > Pull both cords ends under the Buttonhole Foot to the back and place each a cord into a groove of the sole.



- > Lower the Buttonhole Foot.
- > Sew the buttonhole in the usual manner.
- > Pull the cord loop until the loop disappears in the bartack.
- > Pull the cord ends with the sewing needle to the back and knot or secure them.



## 9.6 Sewing a Test Sample

Always sew a test sample of the buttonhole on the same fabric: It is recommended to use the same stabilizer and to select the same buttonhole. The test sample should also be sewn in the respective direction. By sewing a test sample the settings can be adjusted until the sewing result is satisfying.

It is worth underlaying the buttonholes with the Straight Stitch Buttonhole No. 59 when working with soft loosely woven materials and for buttonholes which are severely strained. This is also recommended to reinforce buttonholes in leather, vinyl or felt.

Alterations of the Balance when sewing a manual standard buttonhole as well as the Keyhole and the Round Buttonhole affect both beads in the same way. With the manual keyhole or round buttonhole, the alterations affect both sides in the opposite way.

If the Stitch Counter function is used, and alterations are made concerning the Balance, the alterations affect both buttonhole beads differently.



- > Tap «Buttonholes».
- > Select the buttonhole.
- > Select and fit the desired presser foot.
- > Place the fabric under the presser foot and lower the presser foot.
- > Press the foot control carefully and start sewing. Guide the fabric slightly.
- > Check the Balance while sewing and adjust if necessary.
- > Check the test sample and make further amendments if necessary.

## 9.7 Determining the Buttonhole Slit Width

The width of the buttonhole slit can be adjusted between 0.1 – 2.0 mm before sewing.

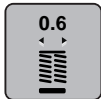


- > Tap «Buttonholes».
- > Select the buttonhole.



- > Tap «i-Dialog».





- > Tap «Buttonhole Slit Width».
- > To adjust the desired width of the buttonhole slit, turn the Upper Multi-function Knob or the «Lower Multi-function Knob».

## 9.8 Determining the Buttonhole Length with the Buttonhole Foot with Slide #3A



The button can be centered in the yellow circle on the display. By turning the «Upper/Lower Multifunction knobs», the yellow circle can be enlarged or downsized to determine the diameter of the button.

2 mm is automatically added to the diameter of the button for the buttonhole length. If the diameter of the button is 14 mm, for example, 16 mm is calculated for the buttonhole length.

Prerequisite:

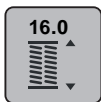
- The Buttonhole Foot with Slide #3A is fitted.



- > Tap «Buttonholes».
- > Select the buttonhole.



- > Tap «i-Dialog».



- > Tap «Direct Entry Buttonhole Length».
- > Turn the «Upper Multi-function Knob» or the «Lower Multi-function Knob» to adjust the buttonhole length.

## 9.9 Determining the buttonhole length with Buttonhole Foot #3C

When the Buttonhole Foot #3C is used, the buttonhole length must be determined via the function Stitch Counter. The stitch counter function is suitable for all types of buttonholes. The left buttonhole bead is sewn forward, the right buttonhole bead is sewn in reverse. If alterations are made to the balance, the stitch counter function has to be saved for every buttonhole separately.

Prerequisite:

- The Buttonhole Foot #3C is fitted.



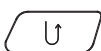
- > Tap «Buttonholes».
- > Select the buttonhole.



- > Tap «i-Dialog».

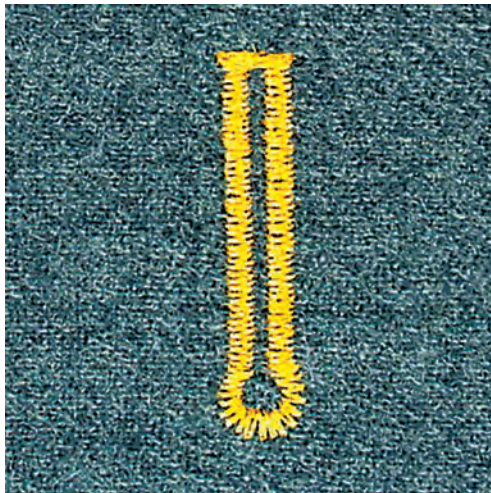
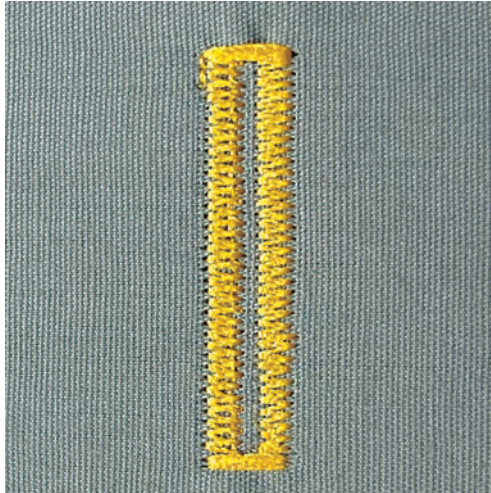


- > Tap «Programming the Length via the Stitch Counter».
- > Sew the desired length of the buttonhole.
- > Stop the machine.



- > The machine sews the lower bartack and the second bead in reverse when the button «Quick Reverse» is pushed.
- > Stop the machine at the height of the first stitch.
- > The machine sews the upper bartack and the securing stitches when the button «Quick Reverse» is pushed again.
  - The length of the buttonhole remains saved and every subsequent buttonhole is sewn identically until the machine is switched off.

## 9.10 Sewing a Buttonhole Automatically



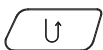
When the Buttonhole Foot with Slide #3A is used, the length of the buttonhole is measured automatically by the lens on the presser foot. The buttonhole will be exactly duplicated and the machine switches to the next step automatically when the maximum length is reached. The Buttonhole Foot with Slide #3A is suitable for buttonholes at a length of 4 – 31 mm, depending on the buttonhole type. The Buttonhole Foot with Slide #3A must lie perfectly flat on the fabric so that the length can be measured accurately. Programmed buttonholes are all at the same length and of the same nice look.

Prerequisite:

- The Buttonhole Foot with Slide #3A is fitted.



- > Tap «Buttonholes».
- > Select the buttonhole.
- > Sew the desired length of the buttonhole.



- > To program the length, push the button «Quick Reverse».



- > Push the button «Start/Stop» or press the foot control.
  - The machine finishes the buttonhole automatically. All subsequent buttonholes are sewn at the same length.

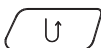
## 9.11 Programming the Heirloom Buttonhole

Prerequisite:

- The Buttonhole Foot with Slide #3A is fitted.



- > Tap «Buttonholes».
- > Select Heirloom Buttonhole No. 63.
- > Sew the desired length of the buttonhole.



- > To program the length, push the button «Quick Reverse».
  - The machine finishes the buttonhole automatically. All subsequent buttonholes are sewn at the same length.

## 9.12 Sewing the manual 7-step buttonhole with the Buttonhole Foot #3C

The length of the buttonhole is determined manually when sewing. The bartack, eye and securing stitches are preprogrammed. The individual steps can also be selected by scrolling using the arrow icons or by pressing the button «Quick Reverse».

Prerequisite:

- The Buttonhole Foot #3C is fitted.



- > Tap «Buttonholes».
- > Select Standard Buttonhole No. 51.



- > Tap «i-Dialog».



- > Tap «Manual Length Adjustment».
  - Step 1 is activated in the display to start the buttonhole.
- > Sew the desired length of the buttonhole.
  - Step 2 is activated.



- > Stop when the required length of the buttonhole or the length marking is reached.
- > Step 3 appears by tapping «Scroll Down».
  - The machine sews straight stitches in reverse.
- > Stop at the height of the first stitch at the start of the buttonhole.
- > Step 4 appears by tapping «Scroll Down».
  - The machine sews the upper bartack and stops automatically.
- > Step 5 appears by tapping «Scroll Down».
  - The machine sews the second bead.
- > Stop the machine at the level of the last stitch of the first bead.

- > Step 6 appears by tapping «Scroll Down».
  - The machine sews the lower bartack and stops automatically.
- > Step 7 appears by tapping «Scroll Down».
  - The machine secures and stops automatically.

### 9.13 Sewing the Manual 5-step Buttonhole with the Buttonhole Foot #3C

The length of the buttonhole is determined manually when sewing. The bartack, eye and securing stitches are preprogrammed. The individual steps can also be selected by scrolling using the arrow icons or by pressing the button «Quick Reverse».

Prerequisite:

- The Buttonhole Foot #3C is fitted.



- > Tap «Buttonholes».
- > Select Round Buttonhole with Normal Bartack No. 54.



- > Tap «i-Dialog».



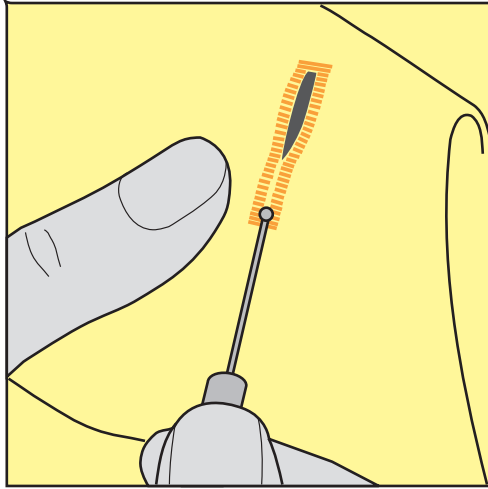
- > Tap «Manual Length Adjustment».
  - Step 1 is activated in the display to start the buttonhole.
- > Sew the desired length of the buttonhole.
  - Step 2 is activated.



- > Stop when the required length of the bead or the length marking is reached.
- > Step 3 appears by tapping «Scroll Down».
- > The machine sews the curve or eye and stops automatically.
- > Step 4 appears by tapping «Scroll Down».
  - The machine sews the second bead in reverse.
- > Stop the machine at the level of the first stitch where the buttonhole begins.
- > Step 5 appears by tapping «Scroll Down».
  - The machine sews the upper bartack and secures automatically.

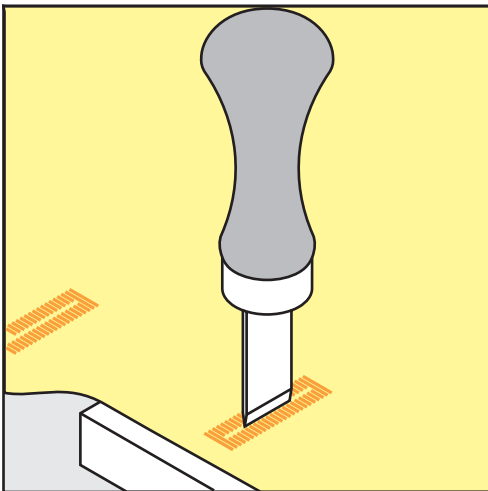
### 9.14 Cutting the Buttonhole Open with the Seam Ripper

- > Place a pin in each end of the buttonhole to avoid accidental cutting into ends of buttonhole.
- > Cut the buttonhole from both ends to the middle.



### 9.15 Cutting Open Buttonholes with the Buttonhole Cutter (Optional Accessory)

- > Place the fabric on an appropriate wood.



- > Position the cutter in the center of the buttonhole.
- > Press down on the cutter with your hand.

### 9.16 Sewing on a Button

The Button sew-on Program can be used to sew on buttons with two or four holes, press studs or snap fasteners.

Recommended sewing program: Button Sew-on Program No. 60

Recommended presser foot : Button Sew-On Foot #18

Alternative presser feet:

- Reverse Pattern Foot #1/1C
- Darning Foot #9
- Reverse Pattern Foot with Clear Sole #34/34C

## Adjusting the Thread Shank

For buttons on thicker fabrics, increase the thread shank = the distance between the button and the fabric. Buttons sewn on thin fabrics or buttons for decorative purposes only are stitched without a «thread shank».

**NOTICE! The adjustment of the thread shank is only possible when using the Button Sew-On Foot #18.**

- > Loosen the screw on the back of the presser foot.
- > Push the bar upwards according to the thickness of the fabric.
- > Tighten the screw.

## Sewing on a Button

Prerequisite:

- The shank length is adjusted according the fabric thickness.
- The Button Sew-On Foot #18 or an alternative presser foot is fitted.
- The fitted presser foot has been selected in the user interface.
- The feed dog is lowered.



- > Tap «Buttonholes».
- > Select Button Sew-on Program No. 60.
- > Turn the handwheel until the bobbin thread comes up.
- > **NOTICE! The Button sew-on program always starts above the left hole of the button.** Position the button on the fabric. Place the button and the fabric beneath the needle so that the needle stitches into the left hole. For buttons with 4 holes, sew the first front pair of holes first.
- > Lower the presser foot.
- > Perform the first stitches in the left hole via the handwheel.
- > Keep turning the handwheel until the needle changes to the right hole. In doing so, check whether the needle goes into the right hole. If necessary, adjust the stitch width by turning the upper Multifunction knob.
- > Hold the threads and push the foot control.
  - The machine sews on the button and stops automatically.
- > For increased stability, sew the Button sew-on Program again.
- > Cut the threads with the machine. Alternatively, pull the sewing projects from under the sewing machine and trim the threads by hand. Pull the upper thread to the wrong side of the fabric and knot it with the bobbin thread.

## 9.17 Sewing Eyelets



For increased stability sew the eyelet twice. Adjust stitch with the balance if necessary.

Prerequisite:

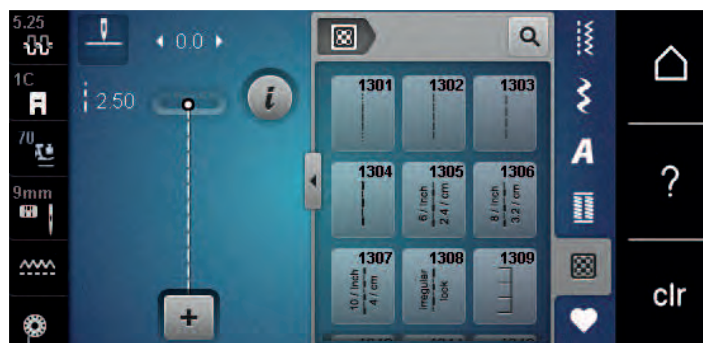
- The Reverse Pattern Foot #1C or the Open Embroidery Foot #20C is fitted.





- > Tap «Buttonholes».
- > Select Eyelet with Small Zigzag No. 61 or Eyelet with Straight Stitch No. 62.
- > Turn the, «Upper Multi-function Knob» or «Lower Multi-function Knob» to alter the size of the eyelet.
- > Sew the Eyelet Program.
  - The machine stops automatically at the end of the Eyelet Program.
- > Use an awl, punch pliers or a hole punch to open the eyelet.

## 10 Quilting

### 10.1 Overview Quilt Stitches



Stitch Pattern	Stitch Number	Name	Description
	No. 1301	Quilting, Securing Program	To secure at the sewing start and sewing end with short stitches forward.
	No. 1302	Quilting, Straight stitch	For machine quilting using a straight stitch with a 3 mm stitch length.
	No. 1303	Piecing stitch/Straight stitch	For sewing patchwork parts together using a straight stitch with a 2 mm stitch length.
	No. 1304 – No. 1308	Hand-look Quilt Stitch	For attaching an imitation of hand-look stitch with monofilament.
	No. 1309 – No. 1314	Blanket Stitch	For appliqués and sewing on ribbons.
	No. 1317 – No. 1327 No. 1329 – No. 1330 No. 1339 – No. 1346 No. 1363 – No. 1371 No. 1373 – No. 1394	Decorative Quilt Stitch	For quilting, crazy patchwork, embellishing and finishing.
	No. 1315	Satin Stitch	For appliqué.
	No. 1316	Narrow Blind Stitch	For hidden sewing of applications.

Stitch Pattern	Stitch Number	Name	Description
	No. 1331	Stippling Stitch/ Stippling Quilt Stitch	For imitations of stippling stitch.
	No. 1332 – No. 1338	Feather Stitch	For quilting, crazy patchwork, embellishing and finishing.

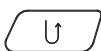
## 10.2 Quilting, Securing Program

Prerequisite:

- The Reverse Pattern Foot #1C is fitted.

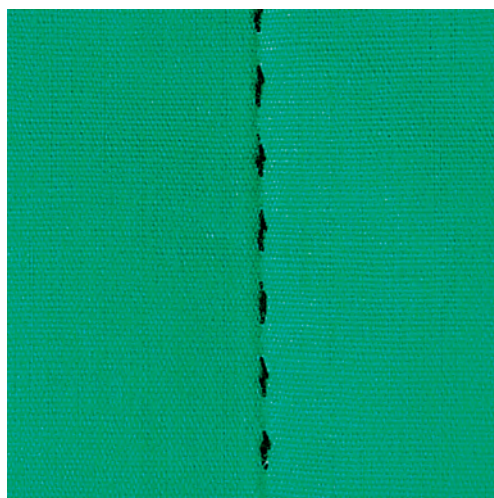


- > Tap «Quilt Stitches».
- > Select Quilting, Securing Program No. 1301.
- > Press the foot control.
  - The machine sews 6 stitches forward automatically when sewing is started.



- > Sew the seam at the desired length.
- > Push the button «Quick Reverse».
  - The machine sews 6 stitches forward automatically and stops automatically at the end of the Securing Program.

## 10.3 Sewing Handlook Quilt Stitches



Hand-look quilt stitches are suitable for all fabrics and sewing projects that should look like hand-sewn. It is recommended to use a monofilament thread as upper thread and an embroidery thread as bobbin thread. The sewing speed should be moderate to prevent the monofilament from breaking. If required, the upper thread tension and the balance can be adjusted to the sewing project and the desired quilt stitch.

Prerequisite:

- The Reverse Pattern Foot #1C is fitted.



- > Tap «Quilt Stitches».
- > Select a Hand-look Quilt Stitch No. 1304 – No. 1308.
- > If necessary, adjust the upper thread tension and the Balance to suit the sewing project and the desired quilt stitch.
- > To start the machine, press the foot control or push the button «Start/Stop».



## 10.4 Guiding the Quilt Work Freely



Freehand quilting and darning use the same principle of free movement. With stipple quilting, entire surfaces of the fabric are filled with quilt stitches. The single lines of stitching are rounded and never cross one another.



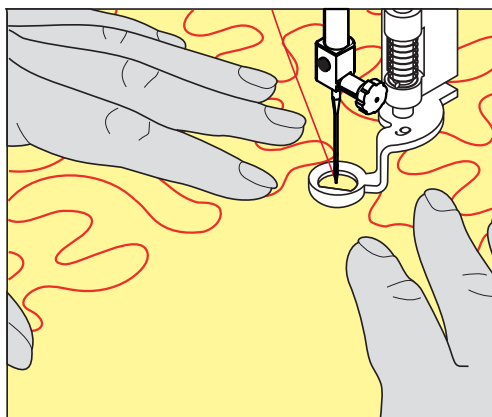
- Quilting gloves with rubber nubs make it easier to guide the fabric.
- For the best possible results use the High Thread Tension Bobbin Case (optional accessory).
- It is recommended to use the slide-on table and the Free Hand System.
- With free motion quilting, it is of advantage to quilt from the center outwards and to guide the fabric using smooth, round movements to form the design of your choice.

Prerequisite:

- The top layer, the batting and the backing are pinned together or basted.
- The feed dog is lowered.
- The Darning Foot #9 is fitted.



- > Tap «Practical Stitches».
- > Select Straight Stitch No. 1.
- > If required, adjust the upper thread tension.
- > To prevent the fabric from shifting, select the needle position down.
- > To start the machine, press the foot control or push the button «Start/Stop».
- > Hold both hands close to the presser foot like an embroidery hoop to guide the fabric. Make sure that the needle does not pierce the same place several times in a row.
- > To ensure a minimum stitch distance when quilting corners, reduce the embroidery speed.
- > If the thread is lying on top of the fabric, slow down the movement.
- > If there are knots on the wrong side of the fabric, move the fabric more quickly.



## 11 BERNINA Stitch Regulator (BSR)

The BERNINA Stitch regulator equalizes the stitch length which results of the free movement of the fabric while free-motion sewing - a sewing technique which grows more and more popular. When free-motion sewing with the BSR presser foot, every stitch is equally long and the stitch formation is perfectly regular.

As soon as the BSR presser foot is attached and the feed dog is lowered, the selection menu of the desired mode appears in the display of the machine. The BSR presser foot can be used with sewing straight stitch as well as zig zag.

The BSR presser foot reacts on the movement of the fabric and therefore controls the speed of the machine up to the highest possible speed. It can be said: The faster the movement of the material, the higher the speed of the machine.

If the fabric is moved too quickly, an acoustic signal sounds. The beeper can be activated or deactivated in the «BSR» display. The sound of the beeper can also be activated or deactivated in the Setup Program.

### 11.1 BSR Mode 1

The BSR function can be controlled via the foot control or the button «Start/Stop». Start the BSR mode. At the BSR presser foot a red light is on. By moving the fabric the machine accelerates. If the fabric isn't moved, securing in place is possible without pressing an additional button. When working via the foot control or when using the button «Start/Stop», the BSR mode doesn't stop automatically.

### 11.2 BSR Mode 2

The BSR function can be controlled via the foot control or the button «Start/Stop». The machine starts only when the foot control or the button «Start/Stop» is pressed and the fabric is moved simultaneously. Without moving the fabric, the BSR2 mode stops after 7\_seconds. The red light goes off (only when working with the button «Start/Stop»). When working via the foot control, the red light doesn't go off.

### 11.3 BSR Function with Straight Stitch No. 1

This function allows free-motion quilting with straight stitch and a pre-programmed stitch length up to 4 mm. The programmed stitch length is maintained within a certain speed, independent of the fabric movement.

### 11.4 BSR Function with Zigzag No. 2

The zig zag can be used e.g. for thread painting. The set stitch length will **not** be maintained when sewing the zig zag stitch, but the BSR function simplifies the application. Anwendung.

## 11.5 Sewing Preparations for Quilting

### Attach the BSR Presser Foot

Prerequisite:

- The machine is switched off.
  - The needle is raised.
  - The presser foot is raised.
- > Remove the fitted presser foot.  
> Attach the BSR presser foot.

- > Insert the plug for the cable vertically into the BSR connection (1) until you feel it click into place.



- > Switch the machine on.
  - The BSR display opens and the BSR 1 mode is activated.

## Changing the Presser Foot

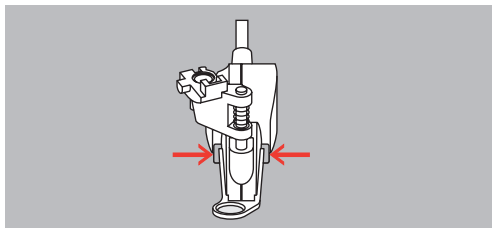
### NOTICE

#### The Lens of the BSR Presser Foot is Dirty

The machine doesn't recognize the BSR presser foot.

- > Clean the lens with a soft, slightly damp cloth.

- > Raise the needle.
- > Raise the BSR foot.
- > Switch off the machine.
- > Remove the BSR foot from the machine.
- > Press both push buttons at the BSR foot against each other.



- > Pull the presser foot sole out of the guide downwards.
- > Insert the new presser foot sole into the guide and push upwards until it clicks into place.
- > Attach the BSR presser foot.

## 11.6 Using the BSR Mode

The BSR function can either be operated via the foot control or via the button «Start/Stop».

Start via the Foot Control: The foot control must be pressed down while quilting is in progress. The machine keeps running in BSR Mode 1 until the foot control is released, even if the fabric is not moved.

If quilting in BSR Mode 2 is stopped, the machine sews another stitch depending on the needle position and stops with needle position up.

Prerequisite:

- The slide-on table has been fitted.
- The knee lifter is attached.

> Lower the feed dog.

> Select the desired BSR Mode.



> To lower the presser foot, push the button «Start/Stop» or press the foot control.

> To start the BSR Mode, push the button «Start/Stop» again or press and hold the foot control again.

- A red light is lit on the BSR Presser Foot.

> Move the fabric to control the speed of the machine in the BSR Mode.



> To stop the BSR Mode, push the button «Start/Stop» again or release the foot control.

- The BSR Mode stops and the red light at the presser foot goes off.



> To deactivate the BSR Mode and to quilt without automatic stitch lengths, tap «BSR Mode».



## 11.7 Securing Stitches

### Securing in BSR1 Mode with the Button «Start/Stop»

Prerequisite:

- The BSR presser foot is fitted and connected to the machine.
- The BSR display opens and a BSR1 Mode is active.

> Lower the feed dog.

> Lower the presser foot.



> Push the button «Needle position Up/Down» 2x.

- The bobbin thread is brought up.

> Hold the upper and the bobbin thread.



> Push the button «Start/Stop».

- Start the BSR Mode.

> Sew 5 – 6 securing stitches.



> Push the button «Start/Stop».

- The BSR Mode stops.

> Cut the thread.

### Securing in BSR2 Mode

Prerequisite:

- The BSR presser foot is fitted and connected to the machine.
- The BSR display opens and a BSR2 Mode is active.

> Lower the presser foot.



## 12 My BERNINA Embroidery

### 12.1 Overview Embroidery Module



- |   |                                |   |                             |
|---|--------------------------------|---|-----------------------------|
| 1 | Release Lever/Carrying Handle  | 4 | Guide Rails for the Machine |
| 2 | Embroidery Arm                 | 5 | Connection to the Machine   |
| 3 | Coupling for Securing the Hoop |   |                             |

### 12.2 Supplied Accessories Embroidery Module

#### Overview Accessory Embroidery Module







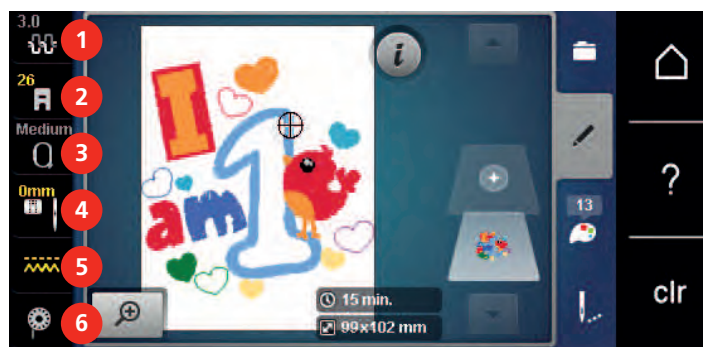
Illustration	Name	Purpose
	Drop-shaped Embroidery Foot #26	For embroidering, darning and freehand quilting.

Illustration	Name	Purpose
	<p>Large Oval Embroidery Hoop</p>	<p>To embroider large embroidery designs or design combinations up to 145 x 255 mm (5.70 x 10.04 in).</p> <p>Template for precise fabric positioning included.</p>
	<p>Medium Embroidery Hoop</p>	<p>To embroider medium-sized embroidery designs up to 100 x 130 mm (3.94 x 5.12 in).</p> <p>Template for precise fabric positioning included.</p>
	<p>Embroidery Needle Assortment</p>	<p>For embroidering.</p>
	<p>Template Holder</p>	<p>To place and remove the template in or out of the embroidery hoop.</p>
	<p>Spool Net</p>	<p>For even thread unwinding with smooth threads from the thread spool, e.g. nylon, rayon, silk threads or metallic yarns.</p>

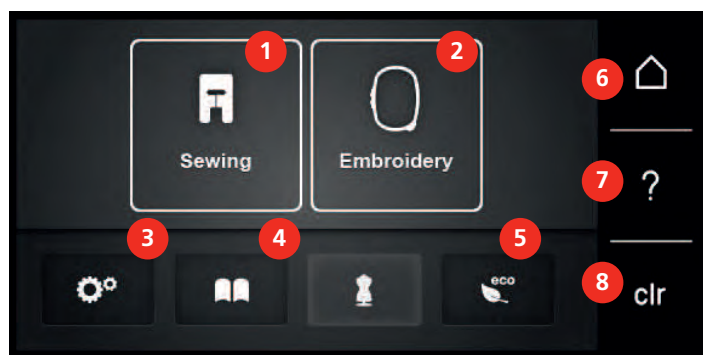
## 12.3 Overview User Interface

### Overview Functions/Visual Information



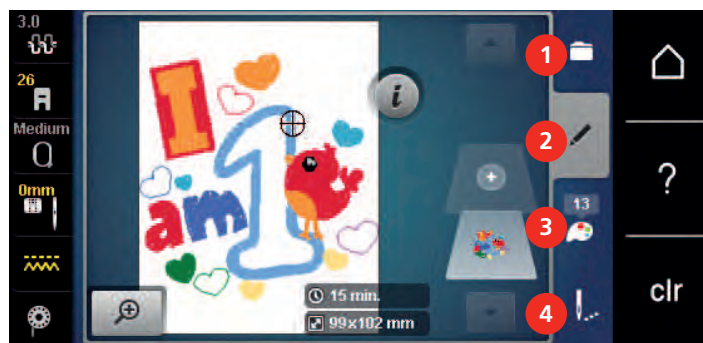
- |   |   |   |                                 |
|---|---|---|---------------------------------|
| 1 | «Upper Thread Tension»                          | 4 | «Stitch Plate/Needle Selection» |
| 2 | «Presser Foot Indicator/Presser Foot Selection» | 5 | «Feed Dog Indicator»            |
| 3 | «Hoop Indicator/Select Hoop»                    | 6 | «Bobbin Thread»                 |

### Overview System Settings



- |   |                   |   |                  |
|---|-------------------|---|------------------|
| 1 | «Sewing Mode»     | 5 | «eco Mode»       |
| 2 | «Embroidery Mode» | 6 | «Home»           |
| 3 | «Setup Program»   | 7 | «Help»           |
| 4 | «Tutorial»        | 8 | «Clear Settings» |

### Overview Selection Menu Embroidery



- |   |             |   |                     |
|---|-------------|---|---------------------|
| 1 | «Selection» | 3 | «Color Information» |
| 2 | «Edit»      | 4 | «Embroidery»        |



## 12.4 Important Embroidery Information

### Upper Thread

A good quality thread (name-brand manufacturer) is essential for embroidery so that the embroidery is not affected negatively because of poor thread or thread breakage.

Embroidery is particularly effective if you use 40wt glossy rayon or polyester embroidery threads as upper threads. They are available in a wide range of colors for beautiful embroidery.

- Polyester with a brilliant sheen is a hard-wearing, colorfast thread and has a high tensile strength which is suitable for all types of embroidery.
- Rayon is a soft viscose fiber with a brilliant sheen and suitable for fine, delicate embroidery, or items that will not receive excessive wear and tear.
- Metallic thread is a light to medium-weight thread suitable for special effects in embroidery.
- When working with metallic threads, the automatic bobbin thread cutter should be deactivated. The other thread cutters shouldn't be used either because the knives are likely to wear off very quickly.
- When using metallic threads, the speed and the upper thread tension should be reduced.



### Bobbin Thread

In most cases black or white bobbin thread is used for embroidering. When both sides should have the same look, it is recommended to use the same color for bobbin and upper thread.

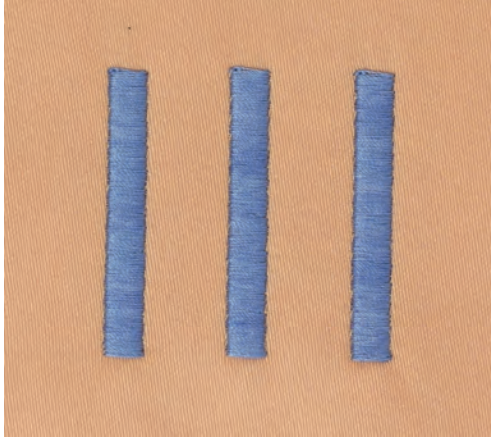
- Bobbin Fill is an especially soft and light polyester thread which is suited to be used as bobbin thread. This special bobbin thread ensures a steady thread tension and an optimal intertwining of the upper and bobbin thread.
- Darning and embroidery threads are fine mercerized cotton threads which are suitable for embroidery on cotton.





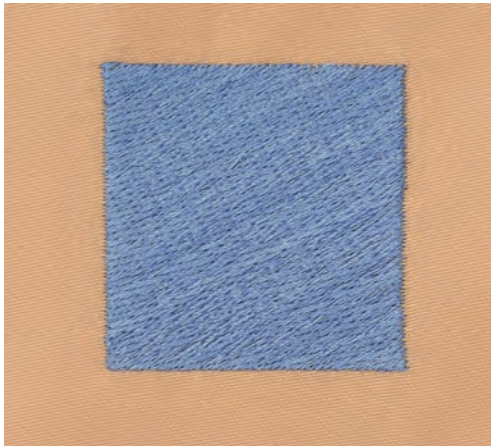
### Satin or Leaf Stich

The needle moves left to right and vice versa. The result is a very dense, covering zig zag stitching to fill the shape. Satin stitching fills are ideal for narrow and small shapes. Satin stitching is, however, not suitable for larger areas, since wide stitches are too loose and do not cover the fabric properly. In addition there is the risk that with too long stitches the threads could catch on something which would damage the embroidery.



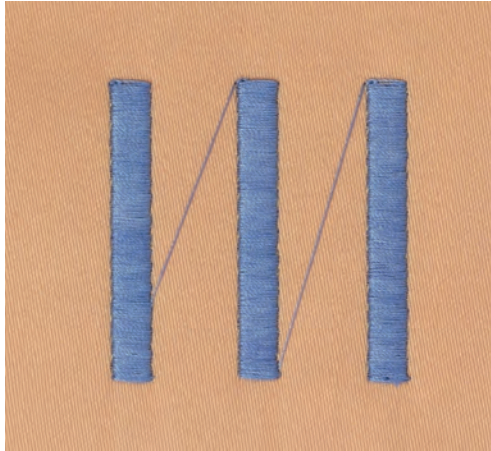
### Step Stitch

Many short, equally long stitches are embroidered in offset rows closely next to each other which results in a densely filled area.



## Connecting Stitches

Long stitches which are used to get from one part of the motif to the next. Before and after the connecting stitch securing stitches are sewn. Connecting stitches are trimmed.



## 13 Embroidering Preparation

### 13.1 Attaching the Embroidery Module

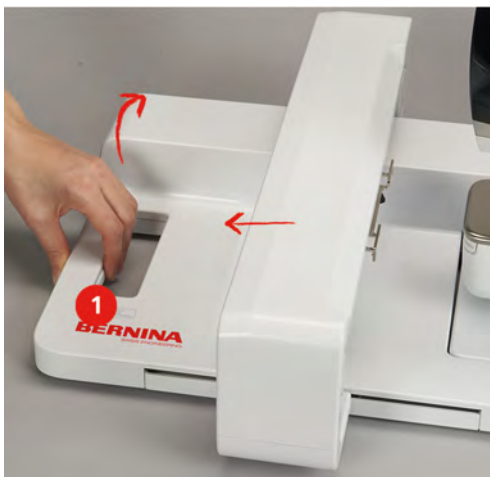
Prerequisite:

- Extension table must not be fitted.
- > Make sure that the module and the machine are placed on a stable, even surface.
- > Ensure that the embroidery arm can move freely.
- > Carefully slide the embroidery module from left to right into the machine's embroidery module connection (1) and the guide rail (2).



### 13.2 Removing the Embroidery Module

- > Push the release lever (1) at the carrying handle of the embroidery module, keep it pressed and at the same time, move the embroidery module carefully to the left.



## 13.3 Preparing the Machine

### Lower the Feed-dog

- > To lower the feed dog, push the button «Feed Dog Up/Down».



- > Fit the straight- and CutWork stitch plate (optional accessory).
- > Fit the needle.
- > Fit the embroidery foot.

### Selecting the Embroidery Design

All of the embroidery designs can be either directly embroidered or can be changed using different functions offered by the embroidering machine. All the embroidery designs can be found at the end of this instruction manual. In addition to that, embroidery designs can be loaded from the personal memory or from the BERNINA USB stick (optional accessory).



- > Tap «Home».



- > Tap «Embroidery Mode».
- > Select an alphabet, embroidery design or a personal embroidery design from one of the files.



## 13.4 Embroidery Foot

### Attaching the Embroidery Foot

- > Raise the needle.
- > Raise the presser foot.
- > Switch off the machine.
- > Push the clamping lever up (1).

- > Remove the presser foot (2).



- > Insert the embroidery foot from below into the bracket.
- > Press the clamping lever down.



### Selecting the Stitch Plate in the User Interface

After having fitted the appropriate embroidery foot (Embroidery Foot #26, supplied accessory) it can be selected and saved on the machine. Moreover optional presser feet can be displayed which are available for the currently selected embroidery design.

- > Switch the machine on.
- > Select the embroidery design.
- > Tap «Presser Foot Indicator/Presser Foot Selection».
- > Select the fitted embroidery foot.



## 13.5 Needle and Stitch Plate

### Inserting the Embroidery Needle



Embroidery needles of the type 130/705 H-SUK provide a larger eye and are slightly rounded. This avoids thread abrasion when using Rayon- and cotton embroidery thread. Depending on the embroidery thread use a size No. 70-SUK to No. 90-SUK needle.

- > Raise the needle.
- > Switch off the machine.
- > Remove the fitted foot.
- > Loosen the fixing screw for the needle by hand.



- > Pull the needle down.
- > Hold the new needle with the flat side to the back.
- > Insert the needle as far as it will go.
- > Tighten the fixing screw by hand.

### Selecting the Embroidery Needle in the User Interface

After changing the needle, you can check whether this can be used with the selected stitch plate.



- > Tap «Stitch Plate/Needle Selection».
- > Select the fitted needle.



- If the selected needle is suitable in combination with the stitch plate, embroidering can be started.
- If the selected needle is not suitable in combination with the stitch plate, starting the machine is automatically blocked.

### Selecting Needle Type and Needle Size

Useful reminder function: So that no information is lost, the needle type and needle thickness can also be saved on the machine. This means that the saved needle type and needle thickness can be checked at any time.

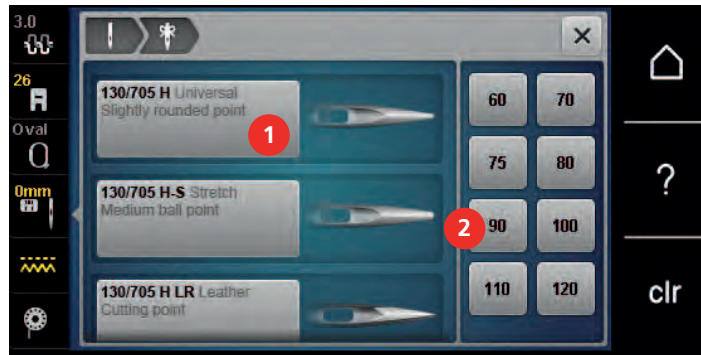


- > Tap «Stitch Plate/Needle Selection».





- > Tap «Needle Information».



- > Select the needle type (1) of the fitted needle.
- > Select the needle type (2) of the fitted needle.

### Adjusting the Needle Position Up/Down



- > To bring the thread up, push the button «Needle position Up/Down».
  - The needle is lowered and raised once.

### Attaching the Stitch Plate

The stitch plate (Straight and CutWork Stitch Plate) has a small hole in the needle area. The stitch formation (thread knotting of upper and bobbin thread) is thus optimized. This results in a more beautiful stitch appearance.

- > To lower the feed dog, push the button «Feed Dog Up/Down».



- > Switch off the machine.
- > Remove the needle.
- > Remove the presser foot.
- > At the marking on the upper right corner of the stitch plate, push the stitch plate downwards until it tips.



- > Remove the stitch plate.
- > Place the opening of the stitch plate (Straight and CutWork Stitch Plate) above the corresponding guide pins and press it down until it clicks into place.

## Selecting the Stitch Plate in the User Interface

After changing the stitch plate, you can check whether it can be used with the selected needle.



- > Tap «Stitch Plate/Needle Selection».
- > Select Straight and CutWork Stitch Plate.



## Thread-up Command

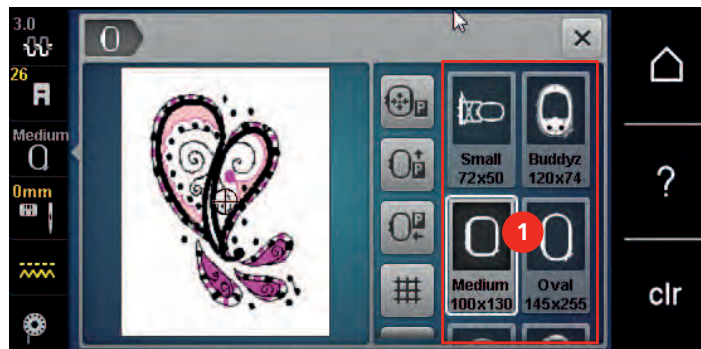
The machine must be ready for embroidery to bring up the bobbin thread. The bobbin thread can be brought up in one step for a manual knotting. If no securing stitches are wanted, it is recommended to deactivate the securing stitches in the Setup.



- > Hold the upper thread.
- > Push the button «Presser Foot Up/Down».
  - The bobbin thread is brought up automatically.

## 13.6 Embroidery Hoop

### Overview Embroidery Hoop Selection



1 Hoop Selection

## Selecting the Embroidery Hoop

The best embroidery result is achieved when the smallest possible embroidery hoop for the embroidery design is selected.

The embroidery design has a pre-set size which is displayed.

Prerequisite:

- The embroidery design is selected.



- > Position the fabric to be embroidered on the stabilizer and press it on place.
- > Remove any adhesive residue before starting the machine.

### Using Water-soluble Stabilizer



For lace embroidery it is recommended to hoop 1 - 3 layers of water-soluble stabilizer in the embroidery hoop. As the embroidery design is not embroidered on the fabric, only the thread embroidered design is left. The embroidery designs should be combined with short stitches otherwise the individual designs may fall out.

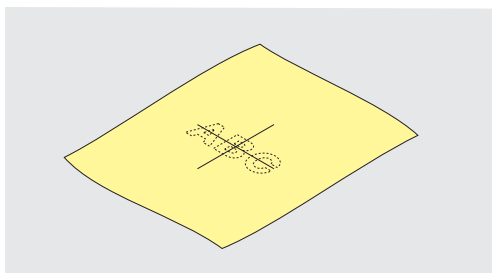
Water-soluble stabilizers are ideal for fine, sheer fabrics where other stabilizers may show through the embroidery stitches as well as for lace embroidery. The stabilizer dissolves in water. Water-soluble stabilizers are an ideal protection for looped pile fabrics preventing the loops from being damaged. It prevents threads from sinking into the material and keeps the fabric pile from poking through the embroidery.

- > Place the stabilizer on the underside of the material.
- > Use adhesive spray to adhere stabilizer if necessary.
- > For material with a pile, reinforce with additional, suitable stabilizer on the wrong side.
- > Place all the layers together into the embroidery hoop.
- > After dissolving, lay the motif down flat and let dry.

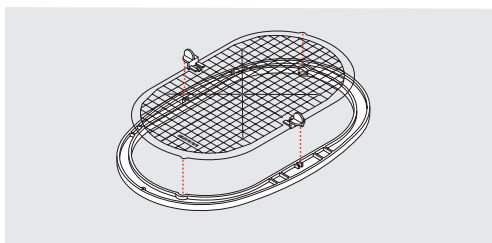
### Preparing the Embroidery Hoop

The embroidery hoop consists of an outer and an inner hoop. There is a corresponding template for every hoop. The area to be embroidered is marked in 1 cm (0.39 inch) squares. The center and corner points are marked with holes. The required marks can be transferred to the material.

- > Mark the center of an embroidery design on the fabric, using a water-soluble pen.

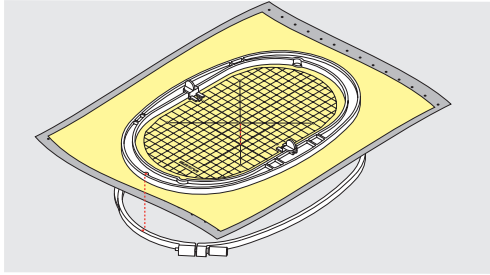


- > Loosen the screw on the outer hoop.
- > Remove the inner hoop.
- > Make sure that the arrows marks of both hoops match.
- > Attach the template holder.
- > Place the template in the inner hoop, so the BERNINA logo is at the front edge at the arrow mark until it clicks into place.



- > Place the fabric under the inner hoop.
- > Line up the marked center point on the center of the template.

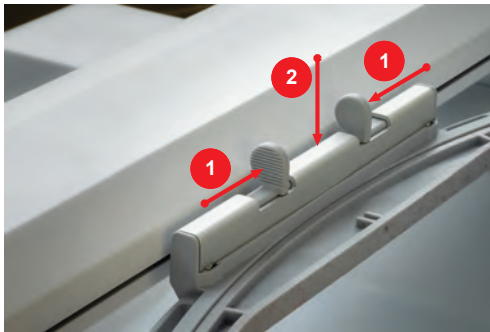
- > Place the material and the inner hoop on the outer hoop, so that the arrow markings of both hoops are aligned.



- > Fit the hoops into each other so that the material does not move.
- > Hoop the fabric tautly in the embroidery hoop.
- > Tighten the screw.
- > Remove the template from the hoop by using the template holder.
- > To avoid scratches on the free arm, press the inner hoop into the outer hoop so that the inner hoop including the fabric protrudes downwards by up to 1 mm.

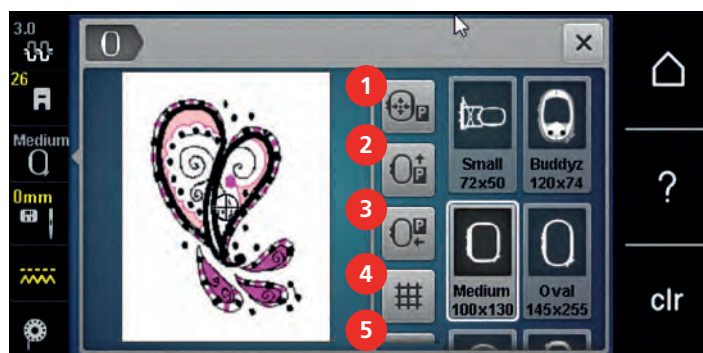
### Attaching the Hoop

- > Raise the needle.
- > Raise the embroidery foot.
- > Hold the hoop with the right side of the fabric up with the attaching mechanism to the left.
- > Position the hoop below the embroidery foot.
- > Press both attaching mechanisms (1) of the hoop towards each other.
- > Position the embroidery hoop (2) above the bracket of the embroidery arm.
- > Press the hoop down until it clicks in position.
- > Release the attaching mechanism (1).



- > Press the attaching mechanisms of the hoop towards each other to remove the hoop.
- > Remove the hoop.

## Overview Embroidery Functions



- |   |   |   |   |
|---|---|---|---|
| 1 | «Centering the Needle to the Embroidery Hoop» | 4 | «Grid On/Off»   |
| 2 | «Move Hoop to the Back»                       | 5 | «Center of Embroidery Design»                           |
| 3 | «Move Hoop to the Left»                       | 6 | «Virtual Positioning»<br>(becomes visible by scrolling) |

## Centering the Needle to the Embroidery Hoop

Relocating the embroidery hoop facilitates threading when the needle is close to the embroidery hoop.



- > Tap «Hoop Indicator/Select Hoop».



- > Tap «Centering the Needle to the Embroidery Hoop».
- > Thread the upper thread.



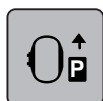
- > To move the hoop back to its previous position, push the button «Start/Stop».

## Move Hoop to the Back

To facilitate changing the bobbin, it is recommended to move the hoop to the back before threading. This makes it easier to open the bobbin cover.



- > Tap «Hoop Indicator/Select Hoop».



- > Tap «Move Hoop to the Back».
- > Thread the bobbin thread. (see page 46)



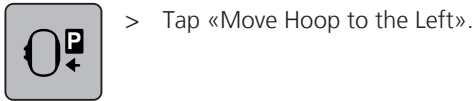
- > To move the hoop back to its previous position, push the button «Start/Stop». If necessary, pull back the upper thread.

## Moving the Module for the Sewing Mode

The embroidery module can be positioned so that any sewing projects can be carried out even if the module is connected.



- > Tap «Hoop Indicator/Select Hoop».
- > Remove the hoop.



> Tap «Move Hoop to the Left».



> Tap «Home».



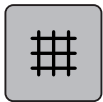
> Tap «Sewing Mode».

### Grid On/Off

When the center of the hoop and the grid are displayed, the embroidery design can be positioned more exactly.



> Tap «Hoop Indicator/Select Hoop».



> To show the hoop center on the display, tap «Grid On/Off».

> To show the grid lines, tap «Grid On/Off» again.

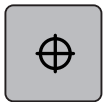
> To hide the hoop center and the grid lines, tap «Grid On/Off» again.

### Locating the Center of the Embroidery Design

The embroidery hoop is positioned so that the needle is exactly above the center of the embroidery design or the motif begin.



> Tap «Hoop Indicator/Select Hoop».



> To position the hoop so that the needle is placed exactly over the center of the embroidery design, tap «Center of Embroidery Design».

> To position the hoop so that the needle is placed exactly over the motif start, tap «Center of Embroidery Design» again.

### Virtual Positioning of the Embroidery Hoop

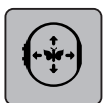
The embroidery hoop is automatically moved to the new position as soon as the embroidery design is repositioned. Therefore, the icon «Virtual Positioning» is activated automatically and outlined in yellow when an embroidery hoop is attached.

Prerequisite:

- The hoop is attached.



> Tap «Hoop Indicator/Select Hoop».



> To deactivate the automatic movement of the hoop after repositioning the embroidery design, tap «Virtual Positioning».

– The «Virtual Positioning» is not yellow-outlined.

> To activate the automatic movement of the hoop after repositioning the embroidery design, tap «Virtual Positioning» again.

## 14 Setup Program

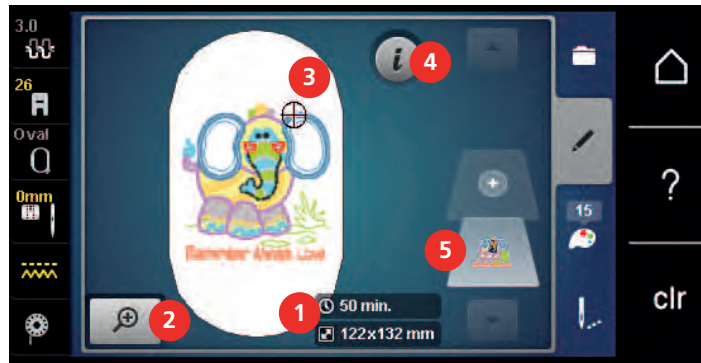
### 14.1 Adjusting the Embroidery Settings in the Setup Program

Further information about this topic (see page 53).



## 15 Creative Embroidering

### 15.1 Overview Embroidering



- |   |  |   |                          |
|---|--|---|--------------------------|
| 1 | Embroidery Time/Embroidery Design Size                       | 4 | «i-Dialog»               |
| 2 | Scaling Up, Downsizing and Moving the Embroidery Design View | 5 | Embroidery design Layers |
| 3 | Area to be Embroidered                                       |   |                          |

### 15.2 Selecting and Changing the Embroidery Design



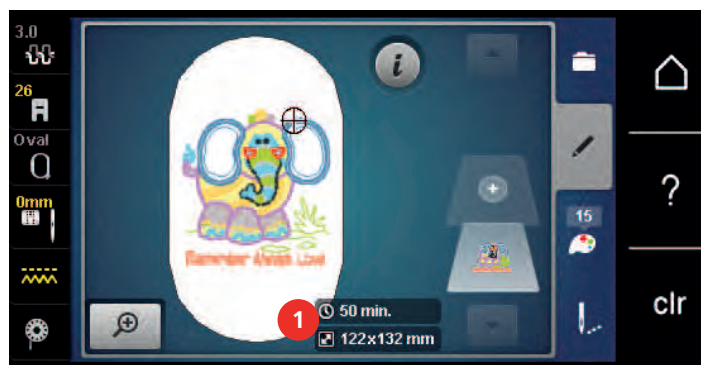
- > Tap «Selection».



- > Tap «Loading the Embroidery Design».
- > Select a new embroidery design.

### 15.3 Checking the Embroidery Time and the Embroidery Design Size

In the display «Editing» at lower right (1), the estimated embroidery time is indicated in minutes and the width and height of the embroidery design is indicated in millimeters.



### 15.4 Regulating the Speed

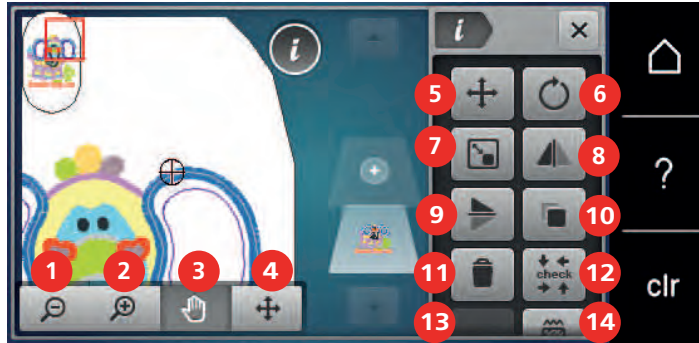
The sewing speed can be adjusted infinitely variable with the slide.

- > Move the slide to the left to reduce the sewing speed.
- > Move the slide to the right to increase the sewing speed.

## 15.5 Editing the Embroidery Design

### Overview Editing Embroidery Design

- > To edit an embroidery design, select the embroidery design.
- > Tap «i-Dialog».



- |   |                                  |    |  |
|---|----------------------------------|----|--|
| 1 | «Zoom Out»                       | 8  | «Mirror Image Left/Right»                  |
| 2 | «Zoom In»                        | 9  | «Mirror Image Up/Down»                     |
| 3 | «Move View»                      | 10 | «Duplicating»                              |
| 4 | «Relocating a Stitch Pattern»    | 11 | «Deleting»                                 |
| 5 | «Relocating a Stitch Pattern»    | 12 | «Check Embroidery Design Size»             |
| 6 | «Rotating the Embroidery Design» | 13 | «WordArt»<br>(only with selected alphabet) |
| 7 | «Change Design Size»             | 14 | «Alter Stitch Type/Stitch Density»         |

### Scaling Up the Embroidery Design View

The view of the embroidery design can be scaled up. In addition to that, the view can be adjusted with or without changing the embroidery position.

- > Select the embroidery design.
- > To edit the view of the embroidery design, tap «Zoom In».



- > To scale up the view of the embroidery design, tap «Zoom In» 1 up to 4 times.



- > To get back to the Edit Mode, tap «Zoom Out» 1 up to 4 times.

### Downsizing the Embroidery Design

The view of the embroidery design can be downsized. In addition to that, the view can be adjusted with or without changing the embroidery position.

- > Select the embroidery design.
- > To edit the view of the embroidery design, tap «Zoom In».



- > To downsize the view of the enlarged embroidery design gradually, tap «Zoom Out» 1 – 4 times.

## Moving the Embroidery Design View

The view of the embroidery design can be moved. In addition to that, the view can be adjusted with or without changing the embroidery position.



- > Select the embroidery design.
- > To activate «Move View», tap «Zoom In».



- «Move View» is activated (dark gray).
- > Move the view of the embroidery design.
- The embroidery position is not altered.



- > To get back to the Edit Mode, tap «Zoom Out».

## Moving the Embroidery Design in Enlarged View

In addition to that, the view can be adjusted with or without changing the embroidery position. In addition to that, the view can be adjusted with or without changing the embroidery position.



- > Select the embroidery design.
- > To display the icon «Relocating a Stitch Pattern», tap «Zoom In».



- > Tap «Moving the Embroidery Design».
- The icon turns dark gray.
- > Move the view of the embroidery design.
- The embroidery position is altered.

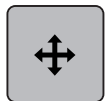


- > To get back to the Edit Mode, tap «Zoom Out».

## Moving the Embroidery Design



- > Select the embroidery design.
- > Tap «i-Dialog».



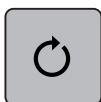
- > Tap «Moving the Embroidery Design».
- > Turn the «Upper Multi-function Knob» to move the embroidery design horizontally in 1/10-mm steps.
- > Turn the «Lower Multi-function Knob» to move the embroidery design vertically in 1/10 mm steps or tap and hold the embroidery design to move the embroidery design as you like.
- The relocation is indicated in the yellow-outlined icons.



- > Tap «Center of Embroidery Design».
- The embroidery design is repositioned in the center of the embroidery hoop.

## Rotating the Embroidery Design

- > Select the embroidery design.
- > Tap «i-Dialog».



- > Tap «Rotating the Embroidery Design».
- > Turn the «Upper Multi-function Knob» or the «Lower Multi-function Knob» to the right to rotate the embroidery design clockwise.
- > Turn the «Upper Multi-function Knob» or the «Lower Multi-function Knob» to the left to rotate the embroidery design counter-clockwise.



- > To rotate the embroidery design in 90°-steps, tap «Rotate the Embroidery Design +90°».

## Altering the Embroidery Design Size Proportionally



Enlargements or reductions of the motif size up to maximum 20 % achieve the best results.

If the motif size is to be altered by more than 20 %, the motif should be adapted in a separate embroidery software and then reloaded onto the machine.

- > Select the embroidery design.
- > Tap «i-Dialog».



- > Tap «Change Design Size».



- > If «Retain Proportions» is not outlined in white, tap «Retain Proportions».
  - «Retain Proportions» is outlined in white.



- > Turn the «Upper/Lower Multi-function Knob» to the right to scale up the embroidery design proportionally.
- > Turn the «Upper/Lower Multi-function Knob» to the left to downsize the embroidery design proportionally.

## Altering the Embroidery Design Size Disproportionally



Enlargements or reductions of the motif size up to maximum 20 % achieve the best results.

If the motif size is to be altered by more than 20 %, the motif should be adapted in a separate embroidery software and then reloaded onto the machine.

- > Select the embroidery design.
- > Tap «i-Dialog».



- > Tap «Change Design Size».



- > If «Retain Proportions» is outlined in white, tap «Retain Proportions».
- «Retain Proportions» is not outlined in white.



- > To make the embroidery design wider, turn the «Upper Multi-function Knob» clockwise.
- > To make the embroidery design narrower, turn the «Upper Multi-function Knob» anti-clockwise.
- > To make the embroidery design longer, turn the «Lower Multi-function Knob» clockwise.
- > To make the embroidery design shorter, turn the «Lower Multi-function Knob» anti-clockwise.

### Mirroring Embroidery Designs

Embroidery designs can be mirror-imaged both vertically and horizontally.

- > Select the embroidery design.
- > Tap «i-Dialog».



- > To mirror the embroidery design horizontally, tap «Mirror Image Left/Right».



- > To mirror the embroidery design vertically, tap «Mirror Image Up/Down».



### Changing the Stitch Type

If the satin stitches are too long, they can be changed to step stitches.

- > Select the Embroidery Design.
- > Tap «i-Dialog».





> Tap «Alter Stitch Type/Stitch Density».



- > Touch the switch in the upper section of the display (1) to change the satin stitch to the step stitch.
- > Set and confirm the stitch length 2.

### Altering the Stitch Density

If the satin stitches are embroidered too densely, the stitch density can be adjusted.

- > Select the embroidery design.
- > Tap «i-Dialog».



> Tap «Alter Stitch Type/Stitch Density».



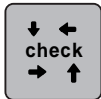
- > Adjust the stitch density (1).

### Checking the Size and the Position of the Embroidery Design

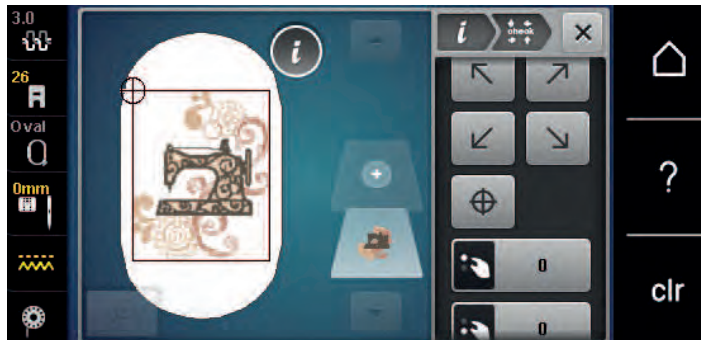
It can be checked whether or not the embroidery design matches the designated position/location on the fabric. Points which are beyond the embroidery hoop are not traveled to.

- > Select the embroidery design.
- > Tap «i-Dialog».





- > Tap «Check Embroidery Design Size».
  - The embroidery hoop travels all the way until the needle is at the position as it is indicated in the display.



- > To select the desired corner of the embroidery design, tap the respective arrow.
  - The embroidery hoop travels all the way until the needle is at the position as it is indicated in the display. If the embroidery design hasn't been positioned correctly yet, the position can be altered via the «Upper/Lower Multi-function knobs» and the complete embroidery positions can be checked again.



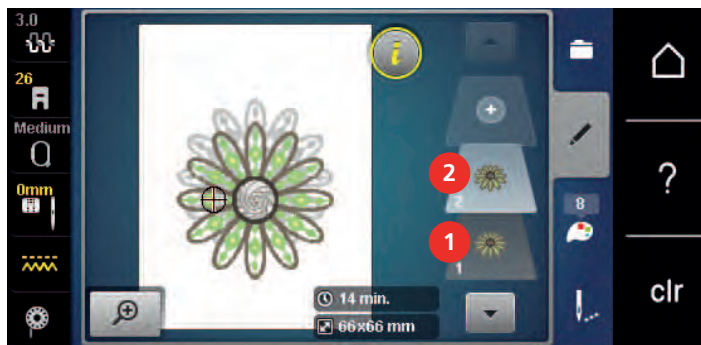
- > To position the needle in the center of the embroidery design, tap «Center of Embroidery Design».
- > Turn the «Upper Multi-function Knob» to move the embroidery design horizontally.
- > Turn the «Lower Multi-function Knob» to move the embroidery design vertically.

## Duplicating the Embroidery Design

- > Select the embroidery design.
- > Tap «i-Dialog».



- > Tap «Duplicating».
  - The embroidery design (1) is duplicated (2).



## Deleting an Embroidery Design

The active embroidery design is deleted.

- > Select the embroidery design.
- > Tap «i-Dialog».



- > Tap «Deleting».

## 15.6 Combining Embroidery Designs

### Combining Embroidery Designs

In the Combi-mode several embroidery designs can be combined.

- > Select the embroidery design.
- > Tap «Adding an Embroidery Design».

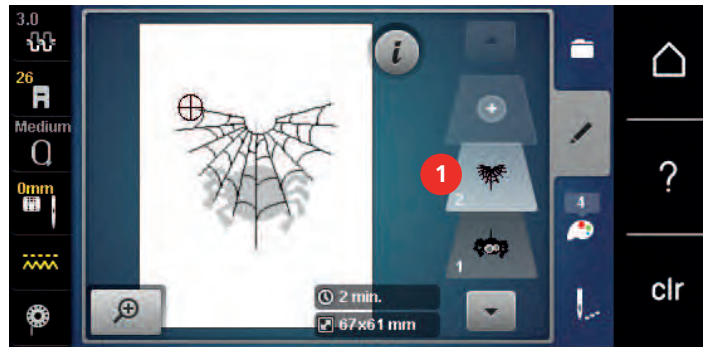


- > Select another embroidery design.

### Deleting a Single Embroidery Design

Prerequisite:

- A combination of embroidery designs has been created.
- > Tap the desired embroidery design in the area of the embroidery design level (1), keep it touched and drag it outwards.
  - A new window opens.



- > To delete the selected embroidery design, tap «Confirm».

### Duplicating a Combination

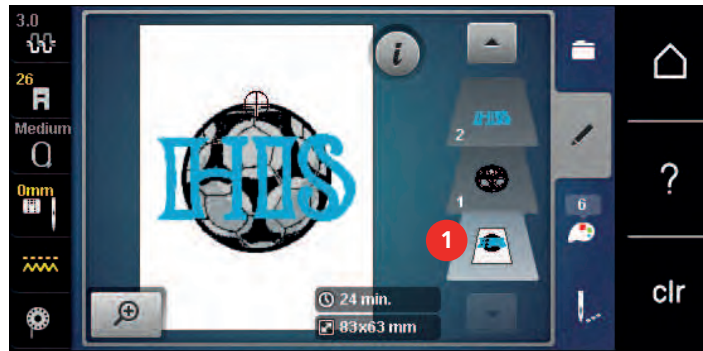
When a combination is duplicated, the individual embroidery designs cannot be selected anymore.

- > Select the embroidery design.
- > Tap «Adding an Embroidery Design».
- > Select another embroidery design.





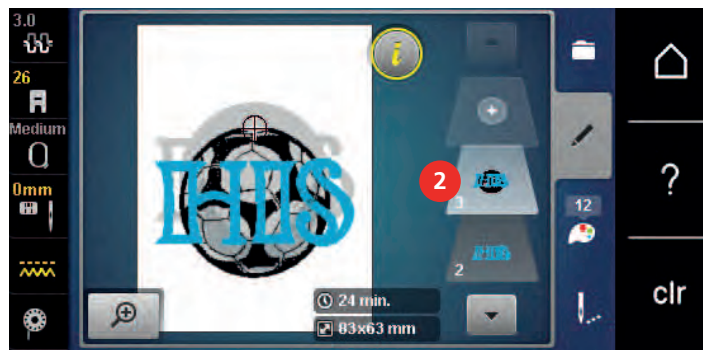
> Select the combination (1).



> Tap «i-Dialog».



> Tap «Duplicating».



– The combination is duplicated (2).

## 15.7 Creating Lettering

### Overview Embroidery Alphabets

Embroidery Design	Name
<b>ABC</b>	Swiss Block
<i>ABC</i>	Anniversary
ABC	Quilt Block
<b>ABC</b>	Childs Play
<b>АБВ</b>	Russian Textbook
<i>ABC</i>	Curly
<b>ABC</b>	Rounded Sans

## Creating Lettering



- |   |                         |   |                                       |
|---|-------------------------|---|---------------------------------------|
| 1 | Entry Field             | 5 | «Numbers and Mathematical Characters» |
| 2 | «Deleting»              | 6 | «Special Characters»                  |
| 3 | «Upper Case Characters» | 7 | «Cancel»                              |
| 4 | «Lower Case Characters» | 8 | «Confirm»                             |



A lettering is always embroidered in one color. To embroider single letters or single words in another color, every letter or every word has to be selected individually and placed in the area to be embroidered.

Lettering can be positioned within the hoop as you like. When the embroidery design is positioned outside the area to be embroidered, the hoop is outlined in red on the display. By means of the hoop selection it is possible to check whether or not the embroidery design can be embroidered in another hoop. If a lettering does not fit into one hoop, individual words can be combined and positioned one below one another, for example.



- > Select «Alphabets».
- > Select an alphabet.
- > Enter and confirm the text.

## Editing the Lettering



- > A lettering has been created.
- > Tap «i-Dialog».



- > Tap «WordArt».
- > To change the distance between the characters in increments of one millimeter, turn the «Upper Multi-function Knob».
- > Turn the «Lower Multi-function Knob» to the left or right to curve the writing upwards or downwards.

## 15.8 Changing the Colors of the Embroidery Design

### Overview Changing the Color

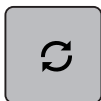


- |   |                            |   |                        |
|---|----------------------------|---|------------------------|
| 1 | «Color Indication»         | 4 | «Altering Color/Brand» |
| 2 | Preview for Selected Color | 5 | «Color Information»    |
| 3 | «Assign Thread Brand»      |   |                        |

### Changing the Colors



- > Select the embroidery design.
- > Tap «Color Information».



- > To change a color, tap «Altering Color/Brand» next to the color to be changed.
- > To display additional colors, swipe up or down on the display.

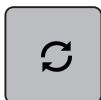


- > To select the color by entering the color number, tap «Color Selection via Number».
- > Enter the number for the required color.
  - The color icon is displayed on the left.
- > To confirm the color selection, touch the color icon that is displayed on the left.

### Changing the Thread Brand



- > Select the embroidery design.
- > Tap «Color Information».



- > Tap «Altering Color/Brand».
- > To display other thread brands, scroll to the left and to the right.



- > Tap «Assign Thread Brand».
- Any thread colors of the selected embroidery design will be matched with the selected thread brand.

## 15.9 Embroidering the Embroidery Design

### Overview Embroidery Menu



- |   |                               |   |   |
|---|-------------------------------|---|---|
| 1 | «Basting»                     | 5 | «Multi-colored Embroidery Design On/Off»                            |
| 2 | «Moving the Hoop»             | 6 | «Increasing the Embroidery Speed»<br>(becomes visible by scrolling) |
| 3 | «Embroidery Sequence Control» | 7 | «Reduce Color Changes»<br>(becomes visible by scrolling)            |
| 4 | «Cut Connecting Stitches»     | 8 | «Color Indication»  |

### Adding Basting Stitches

The basting stitches can be embroidered along the embroidery design. As a result, the fabric and the stabilizer are better fixed together.



- > Select the embroidery design.
- > Tap «Embroidery».



- > To embroider the basting stitches along an embroidery design, tap «Basting».
- > To embroider the basting stitches along the hoop, tap «Basting» again.
- > To deactivate the basting stitches, tap «Basting» again.

### Moving the Hoop

If the embroidery design is so big that repeated rehooping is necessary, the embroidered design can be moved again.



- > Select the embroidery design.
- > Tap «Embroidery».



- > Tap «Moving the Hoop».
- > Turn the «Upper Multi-function Knob» to move the embroidery design horizontally.
- > Turn the «Lower Multi-function Knob» to move the embroidery design vertically.



- > To accept the settings, tap «Embroidery» in the Process Navigation.

## Embroidery Sequence Control when the Thread Breaks

If the thread breaks, the needle can be repositioned in the embroidery design using the function Embroidery Sequence Control.

- > Select the embroidery design.
- > Tap «Embroidery».



- > Tap «Embroidery Sequence Control».
  - A compact view of the embroidery design appears on the left side of the display. On the right side the embroidery design is shown in enlarged view.
- > Select the desired position in the compact view.
- > Turn the «Upper Multi-function Knob» to move the hoop stitch by stitch.
- > Turn the «Lower Multi-function Knob» to move the hoop in large steps.
  - The number in the yellow-outlined icon indicates the number of stitches within the embroidery sequence.



- > To select the desired stitch by entry, tap the icon «Stitch Position via Number».

## Cutting Connecting Stitches

The function is activated as standard and the connection stitches are automatically cut. If the function is deactivated, the connection stitches must be cut by hand.

- > Select the embroidery design.
- > Tap «Embroidery».



- > To switch off the function, tap «Cut Connecting Stitches».
- > To switch on the function, tap «Cut Connecting Stitches» again.



## Reducing Color Changes

When the embroidery designs overlap, the color changes **cannot** be reduced.

- > Select the embroidery design.
- > Tap «Embroidery».



- > Tap «Reduce Color Changes».
  - Identical colors of the embroidery design are collected to one color.



## Multi-colored Embroidery Design On/Off

Multi-colored embroidery designs can also be embroidered in one color.

- > Select the embroidery design.
- > Tap «Embroidery».





- > Tap «Multi-colored Embroidery Design On/Off».
  - The embroidery design is embroidered in one color.

### Color Indication

Every color of the embroidery design can be selected individually. The hoop moves to the first stitch of the current color. The currently active color can be embroidered individually or in another sequence.



- > Select the embroidery design.
- > Tap «Embroidery».
- > Touch the icon Scroll up to select the previous color of the embroidery design.

## 15.10 Freearm Embroidery

Free arm embroidering is defined as embroidering tubular fabrics or garments which are positioned around the free arm of the embroidery machine while being embroidered. Often used with sleeves, pant legs or other narrow-tailored garments.



A fabric tube can be conveniently placed around the freearm of the machine if the embroidery hoop is moved to the left into the park position before attaching or removing it. To return the hoop to the embroidery position afterwards, push the button «Start/Stop».

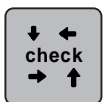
If possible, use a full bobbin as the embroidery hoop must be removed when the bobbin is changed.

The movability of the embroidery arm can be limited or impeded with very narrow tubes. Therefore please make sure that the embroidery hoop can move forwards and backwards sufficiently. An impediment of the embroidery arm caused by a tube which is too tight can result in embroidery design offset or in damaging the fabric.

### Check the Movability of the Freearm

Please note: With tiny fabric tubes, deactivate the thread-away in the Setup Program if necessary.

- > Open the embroidery design on the machine and edit as desired.
- > Mark the embroidery design position and the size on the fabric in a suitable way.
- > Select the embroidery hoop as small as possible.
- > Hoop or stick the fabric along with the appropriate stabilizer in the embroidery hoop, depending on the stabilizer.
- > Pull the fabric tube carefully over the freearm of the machine and attach the embroidery hoop at the clutch of the embroidery module.
- > If necessary, reposition the embroidery design.
- > Tap «Check Embroidery Design Size».
- > After the successful check of the embroidery design size, start the embroidery process.
  - Detailed instructions about embroidery, the use of suitable materials or selecting the required embroidery settings of the machine can be found in the “Tutorial” under embroidery techniques --> Embroidering.



## 15.11 Administering Embroidery Designs

### Administering Embroidery Designs



- |   |                                 |   |                                 |
|---|---------------------------------|---|---------------------------------|
| 1 | «Loading the Embroidery Design» | 3 | «Deleting an Embroidery Design» |
| 2 | «Save Embroidery Design»        |   |                                 |

### Saving Embroidery Designs in the Personal Memory

In the file «Save Embroidery Designs» any embroidery designs including individually edited embroidery designs can be saved.

- > Select the embroidery design.
- > Edit the embroidery design.
- > Tap «Selection».



- > Tap «Save Embroidery Design».
  - The embroidery design to be saved is outlined in yellow.
  - The «Embroidery Machine» is activated.



- > Tap «Confirm».

### Saving the Embroidery Design on the BERNINA USB Stick

- > Select the embroidery design.
- > Edit the embroidery design.
- > Tap «Selection».



- > Tap «Save Embroidery Design».
  - The embroidery design to be saved is outlined in yellow.

> Insert the BERNINA USB stick into the USB port of the machine.



- > Tap «USB Stick».



- > Tap «Confirm».

### Overwriting the Embroidery Design in the Personal Memory

- > Select the embroidery design.
- > Edit the embroidery design.
- > Tap «Selection».



- > Tap «Save Embroidery Design».
  - The embroidery design to be saved is outlined in yellow.
  - The «Embroidery Machine» is activated.



- > Select the embroidery design which is to be overwritten.



- > Tap «Confirm».

### Overwriting the Embroidery Design on the BERNINA USB Stick

- > Select the embroidery design.
- > Edit the embroidery design.
- > Tap «Selection».



- > Tap «Save Embroidery Design».
  - The embroidery design to be saved is outlined in yellow.
- > Insert the BERNINA USB stick into the USB port of the machine.



- > Tap «USB Stick».
- > Select the embroidery design which is to be overwritten.



- > Tap «Confirm».

### Importing Stitch Patterns

Stitch patterns or stitch pattern combinations can be imported from sewing mode into embroidery mode and edited like embroidery designs. For example, border designs can be quickly and easily created and saved as embroidery designs in the folder «Personal embroidery designs».

- > Tap «Home».



- > Tap «Sewing Mode».
- > Select the stitch pattern.



- > Tap «Home».



- > Tap «Embroidery Mode».
  - The stitch pattern is automatically stored in the folder «Personal Embroidery Design».



- > Select «Personal Embroidery Design».
- > Select the stitch pattern.





### Loading an Embroidery Design from the Personal Memory



> Tap «Selection».



> Tap «Loading the Embroidery Design».



> Select «Personal Embroidery Design».  
> Select the embroidery design.

### Loading an Embroidery Design from the BERNINA USB Stick



> Tap «Selection».  
> Insert the BERNINA USB stick into the USB port of the machine.



> Tap «USB Stick».  
> Select a personal embroidery design.

### Deleting an Embroidery Design from the Personal Memory

The embroidery designs which are saved in the personal memory can be deleted individually.



> Tap «Selection».



> Tap «Deleting».



– The «Embroidery Machine» is activated.

> Select the embroidery design which is to be deleted.



> Tap «Confirm».

### Deleting an Embroidery Design from the BERNINA USB Stick



> Tap «Selection».



> Tap «Deleting».  
> Insert the BERNINA USB stick into the USB port of the machine.



> Tap «USB Stick».  
> Select the embroidery design which is to be deleted.



> Tap «Confirm».

## 16 Embroidery

### 16.1 Embroidering via the Button «Start/Stop»

In case of a power cut the embroidery process is interrupted. After the restart the machine goes to the position which was embroidered last.



- > Push the button «Start/Stop» until the embroidery machine starts.
  - All parts of the motif being in the current color are embroidered.
  - The embroidery machine stops automatically at the end.
  - Both threads are cut automatically.
  - The embroidery machine switches to the next color automatically.



- > Change the upper thread.
- > To embroider the new color, push the button «Start/Stop».
  - After finishing the embroidery design, the machine stops automatically and the threads are cut automatically.

### 16.2 Increasing the Embroidery Speed

To ensure the best embroidery quality, the speed when embroidering is reduced depending on the embroidery position. Choose between the two options to either embroider at optimal or maximum speed. Standard = optimal speed. It has to be considered that the quality of the embroidered embroidery design at maximum speed cannot be ensured.

By switching the machine off and on, the optimal embroidery speed is activated.

Prerequisite:

- The embroidery design is selected.



- > Tap «Embroidery Speed».
  - The maximum speed is activated.
- > Tap «Embroidery Speed» again.
  - The optimal speed is activated.

### 16.3 Adjusting the Upper Thread Tension

The default setting of the upper thread tension is set automatically as soon as a stitch pattern or an embroidery design is selected.

The upper thread tension is set optimally at the BERNINA factory and the machine has been tested. Metrosene/Seralon thread size 100/2 (Mettler, Switzerland) is used for the upper and bobbin thread.

When using different types of sewing or embroidery threads, the upper thread tension may vary. Therefore it may be necessary to adjust the upper thread tension according to the sewing or embroidering project as well as the desired stitch pattern or the embroidery design individually.

The higher the upper thread tension is set, the tighter the upper thread is tensioned, and the bobbin thread is pulled deeper into the fabric. When the upper thread tension is low, the upper thread is less tightened, and the bobbin thread is pulled up less into the fabric.

Alterations of the upper thread tension affect the currently selected stitch pattern and all embroidery designs. (see page 49) Permanent alterations of the upper thread tension for the sewing mode and for the embroidering mode (see page 53) can be made in the Setup Program.

Prerequisite:

- The upper thread tension has been altered in the Setup Program.



- > Tap «Upper Thread Tension».
- > Adjust the upper thread tension.



- > Tap the yellow-outlined icon on the right side to reset the alterations to the default setting.
- > Tap the yellow-outlined icon on the left side to reset the alteration to default setting in the **Setup Program**.

## 16.4 Embroidering via the Foot Control

Embroidering with the foot control is recommended if small sequences are to be embroidered, e. g. for stumpwork.

- > To start embroidering, press and keep the foot control pressed.

## 17 Care and Maintenance

### 17.1 Firmware

#### Checking the Firmware Version

The machine's firmware and hardware versions are displayed.



> Tap «Home».



> Tap «Setup Program».



> Tap «Machine Settings».



> Tap «Information».



> Tap «Machine Data».

#### Updating Firmware



The machine's current firmware and detailed step-by-step instructions for the update process can be downloaded from [www.bernina.com](http://www.bernina.com). In general, personal data and settings are automatically transferred during a firmware update. For safety reasons, it is also recommended to save data and settings on a BERNINA USB stick before the firmware update is started. If personal data and settings should be lost during a firmware update, they can be transferred to the machine again afterwards.

Prerequisite:

- Accessories such as the Embroidery module or the BSR Foot which are connected to the machine have been removed.

> Insert the USB stick with the new firmware version into the machine.

> Tap «Home».



> Tap «Setup Program».



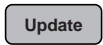
> Tap «Machine Settings».



> Tap «Maintenance/Update».



> Tap «Updating Firmware».



> To start the firmware update, tap «Update»  
 . **Please note:** The update may take several minutes. During the update, do not switch the machine off and do not remove the USB stick.  
 – The machine restarts. Once the update is complete, a message appears.

## Recovering Saved Data

If personal data and settings after a software update are not available anymore, they can be transferred to the machine again afterwards.

> Insert the BERNINA USB stick which provides the saved data and settings into the USB port of the machine.



> Tap «Home».



> Tap «Setup Program».



> Tap «Machine Settings».



> Tap «Maintenance/Update».



> Tap «Updating Firmware».

### NOTICE

BERNINA USB Stick (Optional Accessory) has been removed too early

Saved data cannot be transferred and the machine cannot be used.

> Remove the BERNINA USB stick (optional accessory) only after the saved data has been transferred successfully.



> Tap «Load Data».  
 – After the data has been transferred, a green tick is temporarily displayed.

## 17.2 Machine

### Cleaning the Display

> Clean the display when it is switched off with a soft slightly damp microfiber cloth.

### Cleaning the Feed Dog

Remaining threads under the stitch plate must occasionally be removed.

> Raise the needle and presser foot.

**CAUTION**

### Electronically Driven Components

Risk of injury near the needle and the hook.

> Switch off the machine and disconnect it from the power supply.

> Remove the needle and presser foot.

> Lower feed dog.



> Remove the stitch plate.

**NOTICE**

### Dust and Thread residues inside the Machine

Damage to mechanical and electronic components.

> Use a brush or a soft cloth.

> Do not use compressed air spray.

> Clean the feed dog with the brush.

### Cleaning the Hook

**CAUTION**

### Electronically Driven Components

Risk of injury near the needle and the hook.

> Switch off the machine and disconnect it from the power supply.

> Open the hook cover.

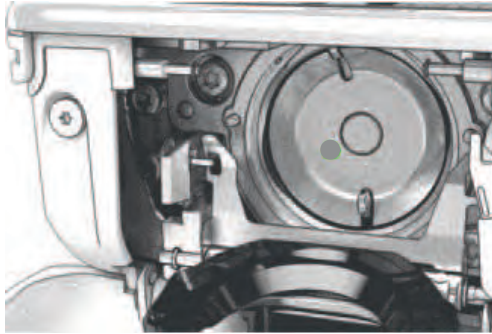
> Remove the bobbin case.

> Push the release bracket to the left.



> Flap down the fastening bracket along with the black hook race cover.

- > Remove the hook.

**NOTICE****Dust and Thread residues inside the Machine**

Damage to mechanical and electronic components.

- > Use a brush or a soft cloth.
- > Do not use compressed air spray.

- > Clean the hook race area with a brush and a soft cloth. Never use any sharp instruments.
- > Hold the hook at the pin in the center with two fingers.
- > Guide the hook with the lower edge diagonally from the top to the bottom behind the hook race cover.
- > Position the hook so that the two lugs on the hook driver fit into the corresponding openings on the hook, and the colored marking on the hook driver is visible in the hole of the hook.
- > Insert the hook.
  - The hook is magnetic and therefore fastened to the correct position.
- > Close the hook race cover and the fastening bracket until the release bracket engages.
- > As a check, turn the handwheel.
- > Insert the bobbin case.

**Lubricating the Hook**

By oiling the hook, the occurrence of unwanted noises in the hook area can be avoided. BERNINA recommends oiling the hook at the following intervals:

- Before using the machine for the first time
- After a longer downtime of the machine
- For intensive use: Daily before sewing
- When the message " Lubricate the Machine " is displayed
- In case of unwanted noises in the hook area

**CAUTION****Electronically Driven Components**

Risk of injury near the needle and the hook.

- > Switch off the machine and disconnect it from the power supply.
- 
- > Remove the bobbin case.

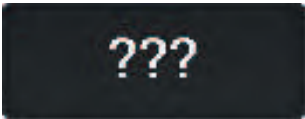









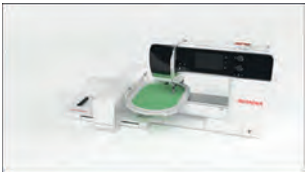
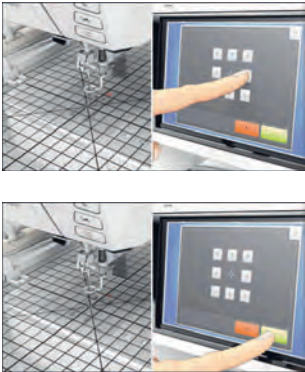

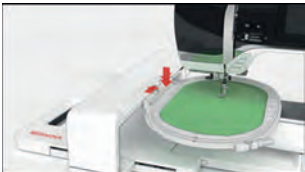
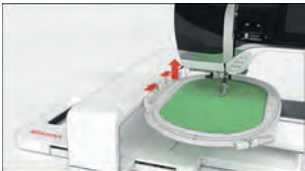











## 18 Errors and Faults


### 18.1 Error Messages

Message on the Display	Cause	Repair
	Stitch number unknown.	> Check the entry and enter the new number.
	Selection of stitch patterns not possible in combi-mode.	> Combine other stitch patterns.
	The feed dog is not lowered.	> To lower the feed dog, push the button «Feed Dog Up/Down».
	The selected needle and stitch plate cannot be used in combination.	> Replace the needle. > Replace the stitch plate.
	The needle is not at its top end.	> Adjust the needle position via the handwheel.
	The upper thread is used up.	> Rethread.
	The upper thread has broken.	> Rethread.
	The bobbin thread is used up.	> Rethread.
	The bobbin thread has broken.	> Clean the hook. > Rethread.


Message on the Display	Cause	Repair
	<p>The main motor is not running.</p>	<ul style="list-style-type: none"> <li>&gt; Turn the handwheel clockwise until the needle is at its top position.</li> <li>&gt; Remove the stitch plate.</li> <li>&gt; Remove the thread remnants.</li> <li>&gt; Clean the hook.</li> <li>&gt; Remove the hook and make sure that there are no pieces of broken needle points on the magnetic back of the hook.</li> <li>&gt; Insert the hook correctly.</li> </ul>
	<p>The contact between the machine and the embroidery module is interrupted as a result of vibrations.</p>	<ul style="list-style-type: none"> <li>&gt; Make sure that the embroidery module and the machine are standing on a stable, even surface.</li> <li>&gt; Connect the embroidery module to the machine.</li> </ul>
	<p>The needle position doesn't correspond with the center of the hoop.</p>	<ul style="list-style-type: none"> <li>&gt; Calibrate the hoop.</li> </ul>
	<p>The embroidery module is not attached.</p>	<ul style="list-style-type: none"> <li>&gt; Connect the embroidery module to the machine.</li> <li>&gt; Contact the specialized BERNINA dealer to have the machine checked.</li> </ul>
	<p>The hoop is not attached.</p>	<ul style="list-style-type: none"> <li>&gt; Attach the hoop.</li> </ul>
	<p>The hoop is attached.</p>	<ul style="list-style-type: none"> <li>&gt; Remove the hoop.</li> </ul>


Message on the Display	Cause	Repair
	The movement of the hoop follows.	> Tap «Confirm».
	Mega Hoop top.	> Bring the Mega Hoop to the top position.
	Mega Hoop center.	> Bring the Mega Hoop to the center position.
	Mega Hoop bottom.	> Bring the Mega Hoop to the lower position.
	The embroidery design is partly outside the hoop.	> Reposition the embroidery design and start embroidering it again.
	The embroidery design is too large.	> Reduce the size of the embroidery design. > Attach a larger hoop.
Not enough free capacity on the BERNINA USB stick (optional accessory).	There is not enough free capacity on the BERNINA USB stick (optional accessory).	> Make sure that the BERNINA USB stick (optional accessory) is used. > Delete data from the BERNINA USB stick (optional accessory).

Message on the Display	Cause	Repair
No personal data on the BERNINA USB stick (optional accessory).	No personal data for recovery available on the BERNINA USB stick (optional accessory).	> Make sure that the data and settings have been saved on the BERNINA USB stick (optional accessory).
The recovery of personal data has failed.	The firmware update has been successful but the personal data could not be recovered.	> Make sure that the data and settings have been saved on the BERNINA USB stick. > Transfer saved data to the machine.
No BERNINA USB stick is inserted. Make sure that the same BERNINA USB stick remains connected during the entire automatic update process.	The BERNINA USB stick (optional accessory) is not inserted.	> Use a BERNINA USB stick (optional accessory) which provides enough free capacity.
The firmware update has failed.	The latest firmware version cannot be found on the USB stick.	> Make sure that the compressed zip file has been unzipped for the firmware update. > Check whether the data for the software update is saved directly on the data medium and not in a file on the USB stick. > Updating Firmware.
	The machine must be cleaned/ lubricated.	> Clean the machine. > Lubricate the hook.  <b>Important Information on Lubricating:</b> Too much oil may stain the fabric and the thread. > After lubricating, sew/embroider a test piece first.
The automatic thread cutter (at the thread catcher) needs cleaning.	The automatic thread cutter needs cleaning. The message appears every time when the machine is started as soon as 1000 cutting cycles have been carried out.	> Tap «Confirm». – The machine calls up the function «Clean the Thread Catcher». > Clean the thread catcher according to the instructions on the display. – The counter for the cutting cycles is reset.

Message on the Display	Cause	Repair
<p>It is time for the regular maintenance. Please contact your authorized BERNINA dealer to make an appointment.</p>	<p>The machine needs maintenance. The message appears after the programmed service interval has expired.</p> <p><b>Important Information:</b> Having your machine cleaned and serviced properly at the appropriate times ensures its proper functioning and a long service life. In case of non-compliance, the service life may be negatively affected and the warranty service may possibly become limited. The cost allocation for maintenance work is regulated nationally. Consult your authorized BERNINA dealer or your service center for more details.</p>	<ul style="list-style-type: none"> <li>&gt; Contact an authorized BERNINA dealer.</li> <li>&gt; Delete the message temporarily by touching the icon «ESC».</li> </ul> <p>After the third deletion, the message is not displayed until the next service interval is reached.</p>
	<p>The calibration of the Buttonhole Foot with Slide #3A has failed.</p>	<ul style="list-style-type: none"> <li>&gt; Check the presser foot for ease of movement. If necessary, remove lint, dust and fabric remnants.</li> <li>&gt; Clean the reflector with a soft, slightly damp microfiber cloth.</li> <li>&gt; Check the position of the reflector. If necessary, correct the position of the reflector or replace the presser foot.</li> <li>&gt; Check the plastic on the underside of the presser foot for signs of wear. If necessary, replace the presser foot.</li> <li>&gt; Clean the feed dog.</li> <li>&gt; If the error still occurs, contact your authorized BERNINA dealer.</li> </ul>

## 18.2 Troubleshooting

Fault	Cause	Repair
<b>Uneven Stitch Formation</b>	Upper thread too tight or too loose.	> Adjust the upper thread tension. > Check the thread feed from the thread spool.
	Needle blunt or bent.	> Replace the needle, make sure that a new BERNINA quality needle is used.
	Poor quality needle.	> Use a new BERNINA quality needle.
	Poor quality thread.	> Use quality thread.
	Incorrect needle/thread combination.	> Match the needle with the thread size.
	Incorrectly threaded.	> Rethread.
	The fabric has been pulled.	> Feed the fabric evenly.
<b>Uneven Stitch Formation</b>	Incorrect bobbin case is used.	> Use the supplied bobbin case marked with the triangle.
		
<b>Skipped Stitches</b>	Incorrect needle.	> Use the needle system 130/705H.
	Needle blunt or bent.	> Replace the needle.
	Poor quality needle.	> Use a new BERNINA quality needle.
	The needle is incorrectly inserted.	> Insert the needle with the flat side to the back as far up as it will go into the needle holder and tighten the screw.
	Incorrect needle point.	> Match the needle point to the texture of the material.
<b>Faulty Stitching</b>	Thread remnants between the thread tension discs.	> Fold a piece of thin material and slide the folded edge (not the raw edges) between the thread tension discs.
	Incorrectly threaded.	> Rethread.
	Thread remnants below the bobbin case spring.	> Remove the thread remnants under the spring.

Fault	Cause	Repair
<b>Upper Thread Breaks</b>	Incorrect needle/thread combination.	> Match the needle with the thread size.
	Upper thread is too tight.	> Reduce the upper thread tension.
	Incorrectly threaded.	> Rethread.
	Poor quality thread.	> Use quality thread.
	The stitch plate or the hook tip is damaged.	> Contact the nearest specialized BERNINA dealer to have the damages repaired. > Replace the stitch plate.
	The thread is caught in the area of the thread take-up lever.	> Slide the headframe (1) to the left, then remove it. > Remove the thread remnants. > Insert the 4 knobs of the headframe into the provided notches and slide the headframe to the right.
		
<b>Lower Thread Breaks</b>	The bobbin case is damaged.	> Replace the bobbin case.
	The stitch hole in the stitch plate damaged.	> Contact the nearest specialized BERNINA dealer to have the damages repaired. > Replace the stitch plate.
	Needle blunt or bent.	> Replace the needle.
<b>Needle Breaks</b>	The needle is incorrectly inserted.	> Insert the needle with the flat side to the back as far up as it will go into the needle holder and tighten the screw.
	The fabric has been pulled.	> Feed the fabric evenly.
	Thick fabric has been pushed.	> Use a suitable presser foot, e. g. Jeans Foot #8, for thick fabric. > Use the height compensating tool when sewing over a thick seam.
	Knotted thread.	> Use quality thread.
<b>Stitch Width Not Adjustable</b>	The selected needle and stitch plate cannot be used in combination.	> Replace the needle. > Replace the stitch plate.







## 20 Technical Data

Designation	Value	Unit
Maximum Fabric Thickness	10.5 (0.41)	mm (inch)
Sewing Light	12 to 16	LED
Maximum Speed	1000	Stitches per Minute
Measurements without the Spool Pin (W × H × D)	465 × 330 × 200 (18.30 × 12.99 × 7.87)	mm (inch)
Weight	11.5	kg
Energy Consumption	90	W
Input Voltage	100 – 240	V
Protection Class (Electrical Engineering)	II	
Production Date: To be seen on the type label under «Code».		

## Index

### A

Activate/Deactivate Functions.....	24
Activating the Audio Signals .....	59
Activating the Bobbin Thread Indicator .....	59
Activating the Upper Thread Indicator.....	58
Adjust Values.....	24
Adjusting the Brightness of the Display .....	60
Adjusting the Maximum Sewing Speed .....	49
Adjusting the Presser Foot Position via the Knee Lifter of the Free Hand System.....	36
Adjusting the Sewing Light .....	60
Adjusting the Upper Thread Tension .....	49
Alphabets .....	103
Altering the Embroidery Design Size Disproportionally.....	146
Altering the Embroidery Design Size Proportionally .....	146
Altering the Stitch Density.....	148
Attach the BSR Presser Foot .....	120
Attaching the Hoop .....	139
Attaching the Knee Lifter of the Free Hand System .....	32
Attaching the Module.....	131
Attaching the Stitch Plate.....	135

### B

Back to Basic Setting.....	62
BERNINA Dual Feed.....	66
Buttonholes .....	105

### C

Calibrating the Buttonhole Foot with Slide #3A.....	64
Calibrating the Embroidery Hoop .....	55
Calling Up the Creative Consultant .....	65
Calling Up the Help.....	65
Calling Up the Tutorial .....	65
Changing the Color .....	153
Changing the Needle.....	38
Changing the Presser Foot .....	37
Changing the Stitch Plate.....	40
Checking the Firmware Version.....	162
Child Safety Lock .....	65
Cleaning the Feed Dog .....	163
Cleaning the Hook.....	164
Cleaning the Thread Catcher .....	167

Combination Mode.....	150
Combining Embroidery Designs .....	150
Cord.....	108
Creating Lettering.....	152

### D

Decorative Stitches.....	97
Dispose of the Machine .....	176

### E

Editing the Lettering .....	152
Embroidery file format .....	128
Embroidery Test.....	128
Energy-saving Mode .....	65
Entering Dealer Data.....	61
Environmental Protection .....	10
Error Messages .....	168
Explanation of Symbols .....	11

### F

Firmware	
Activate/Deactivate Functions.....	24
Adjust Values .....	24
Navigation .....	23
Foot Control .....	33
Connecting .....	31

### I

Inserting the Embroidery Needle .....	134
Inserting the Spool Cap.....	34

### L

Lubricating the Hook .....	165
----------------------------	-----

### M

Maintenance and Cleaning .....	163
Moving the hoop to the Back.....	140
Moving the Module for the Sewing Mode.....	140

### N

Navigation .....	23
Needle Stop Up/Down (permanent).....	40
Needle Up/Down	

