



View this machine and more at:

<https://www.thesewingstudio.co.uk>



b77



bernette
SWISS DESIGN

Table of Contents

IMPORTANT SAFETY INSTRUCTIONS	4		
Important information	6		
1 My bernette	8		
1.1 Overview Machine	8		
Overview front controls	8		
Overview front	11		
Overview top	12		
Overview back	12		
1.2 Accessory	13		
Included accessories	13		
Overview presser feet	14		
1.3 Overview User Interface	15		
Overview System settings	15		
Overview functions/visual information	15		
Overview Functions and Views	15		
1.4 Needle, Thread, Fabric	16		
Overview Needles	16		
Example for needle description	18		
Thread selection	18		
Needle/thread combination	18		
2 Sewing preparation	19		
2.1 Connection and Switching on	19		
Connecting the machine	19		
Use of the power cable (only USA/Canada)	19		
Connecting the foot control	19		
Attaching the knee lifter of the Free Hand System	20		
Switching the machine on	20		
Fixing the touchscreen pen	20		
Regulating the speed via the foot control	21		
Raising/Lowering the needle	21		
Programming the foot control individually	21		
2.2 Spool pin	21		
Horizontal spool pin	21		
Second spool pin	22		
2.3 Free arm	23		
2.4 Sewing table and accessory box	23		
2.5 Raising or Lowering the Feed dog	24		
2.6 Using the slide-on table	24		
2.7 Presser foot	25		
			Adjusting the presser position via the knee lifter of the Free Hand System
			25
			Changing the presser foot sole
			25
			Having the presser foot sole displayed in the user interface
			26
			Adjusting the presser foot pressure
			27
	2.8	Needle and stitch plate	27
		Changing the needle	27
		Selecting the needle in the User Interface	28
		Needle stop up/down (permanent)	28
		Changing the stitch plate	28
		Checking the stitch plate in the user interface	29
	2.9	Threading	30
		Threading preparation	30
		Threading the upper thread	30
		Threading the double needle	33
		Winding the bobbin thread	35
		Threading the bobbin thread	36
	3	Setup Program	38
	3.1	Sewing settings	38
		Adjusting the upper thread tension	38
		Adjusting the maximum sewing speed	38
		Programming the securing stitches	38
		Adjusting the hovering height of the presser foot	39
		Programming the button «Securing»	39
		Programming the button «Thread cutter»	40
		Adjusting the presser foot position with needle stop down	40
		Programming the button «Quick reverse»	41
		Programming the foot control individually	41
		Fabric thickness measurement	42
		Adjusting the general balance	42
	3.2	Selecting personal settings	43
	3.3	Monitoring functions	43
		Activating the upper thread indicator	43
		Activating the bobbin thread indicator	43
	3.4	Sound on/off	44
	3.5	Machine settings	44
		Adjusting the brightness of the display	44
		Adjusting the sewing light	44
		Calibrating the display	44
		Back to basic settings	45
		Checking the firmware version	45

Table of Contents

Reviewing the total number of stitches	46	6.4 Sewing in the zipper	63
4 System settings	47	6.5 Sewing Triple straight stitch	64
4.1 Using eco mode	47	6.6 Sewing Triple zigzag	64
4.2 Calling up the Creative Consultant	47	6.7 Manual darning	65
4.3 Cancelling any alterations with «clr»	48	6.8 Automatic darning and Reinforced darning	65
5 Creative sewing	49	6.9 Finishing edges	67
5.1 Overview selection menu sewing	49	6.10 Sewing Double overlock	68
Selecting a stitch pattern	49	6.11 Sewing Vari overlock	68
5.2 Dual Feed (DF)	50	6.12 Edgestitching using the seam guide	68
Application of the Dual Feed	50	6.13 Sewing a narrow hem	69
Use the Dual Feed	50	6.14 Sewing blind hems	70
5.3 Regulating the speed	51	6.15 Sewing visible hems	71
5.4 Adjusting the upper thread tension	51	6.16 Sewing basting stitches	71
5.5 Editing stitch patterns	51	6.17 Sew thick areas	71
Changing the stitch width	51	6.18 Sewing Corners	72
Changing the stitch length	52	7 Decorative stitches	73
Correcting the balance	52	7.1 Overview Decorative Stitches	73
Programming pattern repeat	53	7.2 Altering the stitch density	74
Mirror image of stitch patterns	53	7.3 Sewing cross stitches	74
Editing stitch pattern length	53	8 Alphabets	75
Permanent Quick reverse	54	8.1 Overview Alphabet	75
Backstepping	54	8.2 Creating lettering	75
5.6 Combining stitch patterns	54	9 Buttonholes	77
Overview Combi mode	54	9.1 Overview Buttonholes	77
Creating Stitch pattern combinations	55	9.2 Marking buttonholes	78
Editing a single stitch pattern	55	9.3 Sewing a buttonhole automatically	79
Deleting a single stitch pattern	55	9.4 Reinforce buttonhole	81
Adding a single stitch pattern	56	9.5 Sewing on buttons	81
Mirroring a stitch pattern combination	56	9.6 Sewing eyelets	82
Programming pattern repeat	57	10 Quilting	83
Securing a stitch pattern combination	57	10.1 Overview Quilt Stitches	83
Saving a stitch pattern combination	57	10.2 Quilting, Securing Program	84
Loading a stitch pattern combination	57	10.3 Sewing handlook quilt stitches	84
Overwriting a stitch pattern combination	58	10.4 Guiding the quilt work freely	85
Deleting a stitch pattern combination	58	11 Appendix	86
5.7 Administering stitch patterns	58	11.1 Maintenance and cleaning	86
Saving stitch patterns in personal memory	58		
Overwriting stitch patterns from the personal memory	58		
Loading stitch patterns from the personal memory	59		
Deleting stitch patterns from the personal memory	59		
6 Practical stitches	60		
6.1 Overview Practical stitches	60		
6.2 Sewing straight stitch	62		
6.3 Securing with the automatic Securing Program	62		

Cleaning and maintenance intervals	86
Cleaning the display	86
Cleaning the feed dog	86
Cleaning the hook	86
Oiling the needle bar	88
11.2 Troubleshooting	89
11.3 Error messages	92
11.4 Technical data	94
12 Overview stitch patterns	95
12.1 Overview Stitch patterns	95
Practical stitches	95
Buttonholes	95
Decorative stitches	95
Quilt stitches	97
Index	98

IMPORTANT SAFETY INSTRUCTIONS

Please be aware of the following basic safety instructions when using your machine. Before using this machine, read instruction manual carefully.

DANGER!

To reduce the risk of electrical shock:

- Never leave the machine unattended as long as it is plugged in.
- Always unplug the machine from the electrical outlet immediately after using.

Protection against LED radiation:

- Do not view the LED light directly with optical instruments (e.g. magnifier). The LED light corresponds with protection class 1M.
- When the LED light is damaged or defective, contact your bernette specialist dealer.

WARNING

To reduce the risk of burns, fire, electric shock or injury to persons:

- To operate the machine always use the supplied power cable. USA and Canada only: Do not connect power plug NEMA 1-15 to circuits exceeding 150 volt-to-ground.
- Use this machine only for purposes as described in this manual.
- Only use the machine in dry rooms.
- Do not use the machine in a damp condition or in a damp environment.
- Do not use this machine as a toy. Close attention is necessary when this machine is used by or near children.
- The machine can be used by children older than 8 or by people with reduced physical, sensory or mental capabilities or if there is a lack of experience and knowledge how to operate the machine as long as they are supervised or have been given instruction concerning the responsible use of the appliance and are aware of the involved risks.
- Children are not allowed to play with this machine.
- Cleaning and maintenance work must not be carried out by children unless they are supervised.
- Never operate this machine if it has a damaged cord or plug, if it is not working properly, if it has been dropped or damaged, or dropped into water. Contact the nearest authorized bernette dealer to arrange further details.

- Only use accessory recommended by the manufacturer.
- Don't use this machine when the ventilation openings are blocked. Keep the ventilation openings and the foot control free from the accumulation of lint, dust and loose cloth.
- Never insert any objects into any openings of the machine.
- Do not place any objects on the foot control.
- Always use the machine with a foot control of this type FC-210.
- Do not operate the machine where aerosol products (sprays) or oxygen are being used.
- Keep fingers away from all moving parts. Special care is required around the needle.
- Neither pull nor push the fabric while sewing. This can cause needle breakage.
- When making any adjustments in the needle area – such as such as threading the needle, changing the needle, threading the hook or changing the presser foot – turn power switch to «0».
- Do not use bent needles.
- Always use the original bernette stitch plate. The wrong stitch plate can cause needle breakage.
- To disconnect, turn power switch to «0» and then remove the plug from the outlet. Do not unplug by pulling the cord, instead grasp the plug to pull it from the outlet.
- Always disconnect the power plug from the electrical outlet when the covers are removed or opened, when the machine is lubricated or during any other maintenance adjustments mentioned in the instruction manual.
- This machine is provided with double insulation (except USA, Canada and Japan). Use only identical replacement parts. See instructions for Servicing of double-insulated products.
- The sound pressure level is lower than 70 dB(A) under normal conditions.

Important information

Availability of the instruction manual

The short manual is part of the machine.

- Keep the short manual of the machine in a suitable place near the machine and have it ready for reference.
- A detailed instruction manual can be downloaded from www.mybernette.com.
- When passing on the machine to a third party, enclose the short manual of the machine.

Proper use

Your bernette machine is conceived and designed for private household use. It is intended for sewing fabrics and other materials as described in this instruction manual. Any other use is not considered proper. bernette assumes no liability concerning consequences resulting from an improper use.

Equipment and scope of delivery

Example images are used in these operating instructions for the purposes of illustration. The machines shown in the images and the accessories shown therefore do not always match the actual items included with your machine. The supplied accessory can vary depending on the country of delivery. Accessories mentioned or shown, which are not included in the scope of delivery, can be purchased as optional accessories from a bernette specialized dealer. Further accessories can be found at www.mybernette.com.

For technical reasons and in order to improve the product, changes may be made to the equipment of the machine and the scope of delivery at any time and without prior notice.

Maintenance of double-insulated products

In a double-insulated product, two systems of insulation are provided instead of grounding. No grounding means is provided on a double-insulated product nor should a means for grounding be added to the product. Servicing a double-insulated product requires extreme care and knowledge of the system and should only be done by qualified service personnel. Only original spare parts should be used for service and repairs. A double-insulated product is marked with the words: «Double-Insulation »or «double-insulated».

 The symbol may also be marked on the product.

Environmental Protection

BERNINA is committed to the protection of the environment. We strive to minimize the environmental impact of our products by continuously improving product design and our technology of manufacturing.



The machine is labeled with the symbol of the crossed-out wastebin. This means that the machine should not be disposed of in household waste when it is no longer needed. Improper disposal can result in dangerous substances getting into the groundwater and thus into our food chain, damaging our health.

The machine must be returned free of charge to a nearby collection point for waste electrical and electronic equipment or to a collection point for the reuse of the machine. Information on the collection points can be obtained from your local administration. When purchasing a new machine, the dealer is obliged to take back the old machine free of charge and dispose of it properly.

If the machine contains personal data, you are responsible for deleting the data yourself before returning the machine.

Explanation of symbols



Designates a high-risk hazard which can lead to serious injuries or potentially even death if not avoided.



Designates a medium-risk hazard which can lead to serious injuries if not avoided.



Designates a low-risk hazard which can lead to minor or moderate injuries if not avoided.



Designates a hazard which can lead to material damage if not avoided.

1 My bernette

1.1 Overview Machine

Overview front controls



1 Quick reverse

2 Thread cutter

3 Presser foot up/down

4 Start/Stop

5 Securing





6 Needle up/down



7 Upper Multifunctional knob

8 Lower Multifunctional knob

9 Needle left/right

Operation buttons

Number	Buttons	Name	Purpose
1		Quick reverse	<ul style="list-style-type: none"> > «Keep Quick reverse» pressed to sew in reverse. > Touch the icon «Quick reverse» to sew permanently in reverse. <p>«Quick reverse» doesn't work with the stitch patterns 22-24 and with the buttonhole patterns 51-71.</p>
2		Thread cutter	<ul style="list-style-type: none"> > Press the «Thread cutter» button in order to cut the upper and lower threads automatically. <p>2-6 securing stitches can be programmed in the Setup-Program. These are sewn before the thread is cut.</p>
3		Presser foot up/down	<ul style="list-style-type: none"> > Press the button «Presser foot up/down» to raise the presser foot into hovering position. > Push the button «Presser foot up/down» to raise the presser foot.
4		Start/Stop	<p>The button «Start/Stop» serves the purpose to change the presser foot position and to start the machine.</p> <ul style="list-style-type: none"> > To start the machine, keep the button «Start/Stop» pressed for 2 seconds. > Press the button «Presser foot up/down» briefly to move the presser foot into hovering position.
5		Needle up/down	<ul style="list-style-type: none"> > Push the button «Needle up/down» to lower the needle. > Push the «Needle up/down» button again to raise the needle.

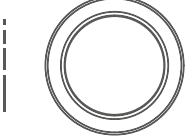
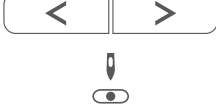
Number	Buttons	Name	Purpose
6		Securing	<p>The function «Securing at sewing start» is activated in the Setup by default and can be deactivated by pressing the button «Securing».</p> <p>When the function «Securing at sewing start» is not activated in the Setup, it can be programmed by pressing the button «Securing».</p> <p>A securing icon which appears on the display during sewing indicates that the function is activated.</p> <p>The number of securing stitches can be programmed in the Setup-Program.</p> <ul style="list-style-type: none"> > To sew the securing stitches first, press the button «Securing» before you start sewing. > To sew the securing stitches at the pattern end, press the button «Securing» while sewing. > To sew securing stitches within a stitch pattern combination, press the button «Securing». <ul style="list-style-type: none"> – The selected pattern of the combination is secured according to the setting.
7		Upper Multifunctional knob	Settings can be changed with the «Upper Multifunctional knob» and the Lower Multifunctional knob.
8		Lower Multifunctional knob	Settings can be changed with the «Lower Multifunctional knob» and the Lower Multifunctional knob.
9		Needle left/right	<p>There is a total of 15 needle positions. The needle position is indicated by the needle position number in the display.</p> <ul style="list-style-type: none"> > Press the «Needle left» button to move the needle to the left. > Press the «Needle right» button to move the needle to the right.

Overview front



- | | | | |
|---|--------------------|----|---------------------------------|
| 1 | Feed dog lever | 8 | Thread cutter |
| 2 | Stitch plate cover | 9 | Slide speed control |
| 3 | Stitch plate | 10 | Thread take-up lever |
| 4 | Presser foot | 11 | Top cover |
| 5 | Sewing light | 12 | LCD Display |
| 6 | Needle threader | 13 | Connection for Free Hand System |
| 7 | Buttonhole lever | 14 | Sewing table and accessory box |



Overview top

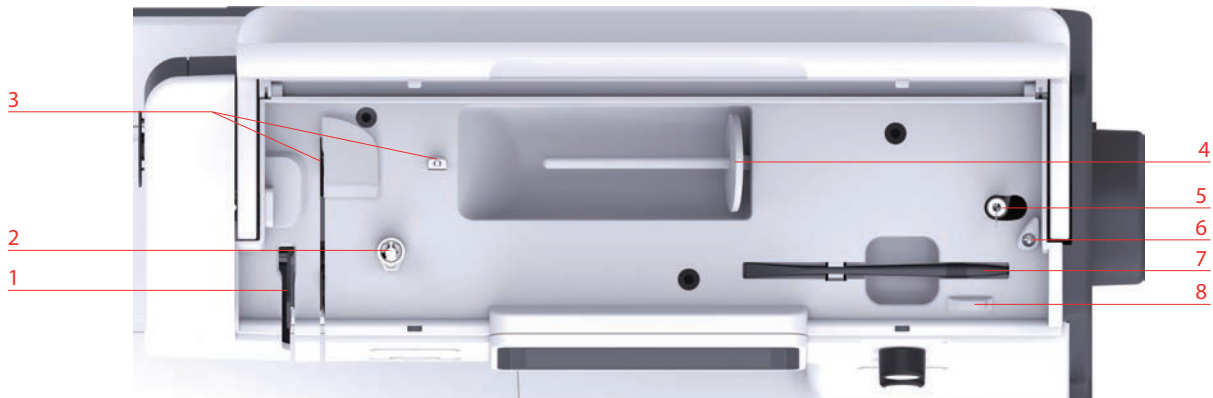

- | | | | |
|---|----------------------|---|--|
| 1 | Thread take-up lever | 5 | Winding unit and holder for second spool pin |
| 2 | Thread pretension | 6 | Stopper winding unit |
| 3 | Thread guide | 7 | Touchscreen pen |
| 4 | Spool pin | 8 | Thread cutter |

Overview back



- | | | | |
|---|-----------------------------|---|--------------------------------|
| 1 | Connection for power cable | 6 | Carrying handle |
| 2 | Air vents | 7 | Air vents |
| 3 | Connection for foot control | 8 | Dual Feed (DF) |
| 4 | Power switch | 9 | Sewing table and accessory box |
| 5 | Handwheel | | |









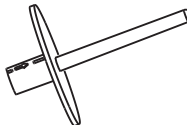
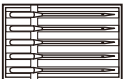

1.2 Accessory

All rights reserved: For technical reasons and for the purpose of product improvements, changes concerning the features of the machine can be made at any time and without advance notice. The supplied accessory can vary depending on the country of delivery.

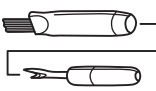
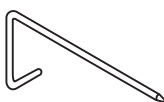

Included accessories

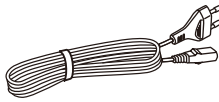
Visit www.mybernette.com/accessories for more accessory information.

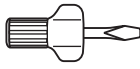
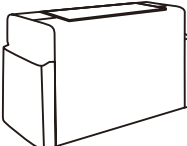
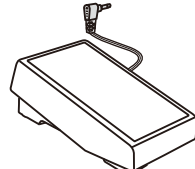
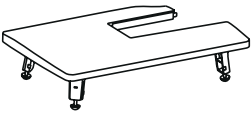
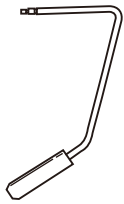

Illustration	Name	Illustration	Name
	Bobbin (3x)		Felt disc
	Spool net		Second spool pin
	Selection of needles		Touchscreen pen
	Brush/ Seam ripper		Seam guide
	Spool disc large		Lubricator
	Spool disc middle (1x)		Power cable
	Spool disc small		Screwdriver
	Dust cover		Foot control
	Slide-on table		Free Hand System

Overview presser feet

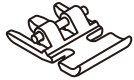
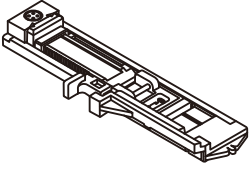
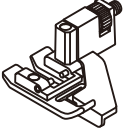
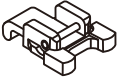
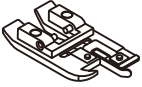
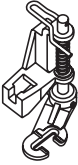
Illustration	Name	Purpose
	Zigzag foot (DA)	To sew practical, decorative stitches and hems.
	Embroidery foot (JK)	To sew buttonholes, appliqués and decorative stitches.
	Zipper foot (JB)	Used to sew with dual feed. To sew in zippers.
	Buttonhole foot with slide (RJ)	To sew buttonholes.
	Blindstitch foot (DM)	To sew blind-stitch hems with Dual Feed.
	Button-sew-on foot (RC)	To sew on button.
	Overlock foot (DI)	Used to sew with dual feed. Overlock stitches over the fabric edge.
	Free motion foot (RX)	For embroidering, darning and free motion quilting.

1.3 Overview User Interface

Overview System settings

Overview functions/visual information

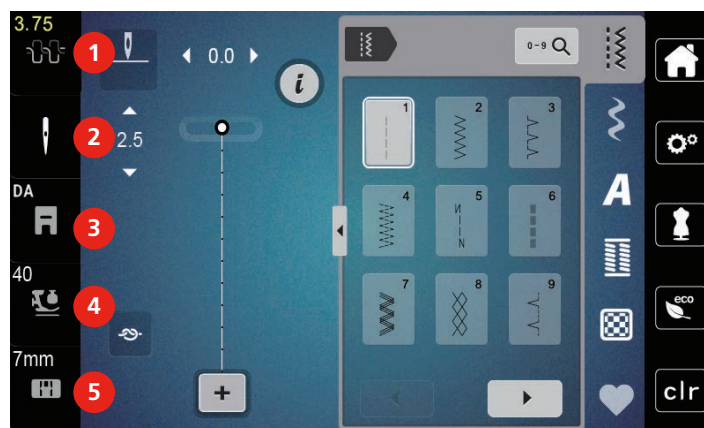

- | | | | |
|---|------------------------|---|------------------------|
| 1 | Upper thread tension | 4 | Presser foot pressure |
| 2 | Needle selection | 5 | Stitch plate selection |
| 3 | Presser foot indicator | | |

Overview Functions and Views







Illustration	Name	Purpose
	Close	The display is closed and the previously made adjustments are saved.
	Icons «-/+»	By touching the icons «-» and «+» the setting values are changed.
	Confirm	Confirms the previously adjusted alterations. The display is closed.
	Cancel	The process is canceled. The display is closed and the previously made adjustments are not saved.
	Slide	By moving the slide the setting values are changed.
	Switch	Activates or deactivates functions.

Illustration	Name	Purpose
	USB storage space	The percentage of used USB storage (%) will be displayed in the green bar icon.
	Yellow-framed icon	Touch the yellow-framed icon to reset the alterations to default setting.



1.4 Needle, Thread, Fabric

In the course of time a needle wears out. Therefore, the needle should be replaced regularly. Only a perfect point results in a good stitching result. In general it can be said: the thinner the thread, the finer the needle. The illustrated needles are either standard or optional accessory, depending on the machine.

- Needle sizes 70, 75: for light-weight fabrics.
- Needle sizes 80, 90: for medium fabrics.
- Needle sizes 100: for heavy fabrics.

Overview Needles

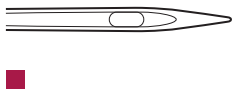
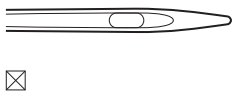
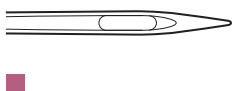
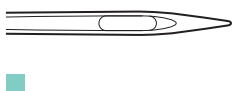
Illustration	Needle name	Needle description	Purpose
	Universal needle 130/705 H 60-120	Slightly rounded point	For nearly all natural and synthetic fabrics (woven and knitted).
	Stretch needle 130/705 H-S 75, 90	Mid-sized ball point, special eye shape and needle scarf	For jersey, tricot, knit and stretch fabrics.
	Jersey/Embroidery needle 130/705 H SUK 60-100	Mid-sized ball point	For knitware, knitted good. For embroidering.
	Jeans needle 130/705 H-J 80-110	Point, narrow point, reinforced shaft	For heavy-weight fabrics such as jeans or canvas.
	Leather needle 130/705 H LR 90, 100	With cutting point (LR = special point to sew leather)	For all types of leather, synthetic leather, plastic, sheeting.
	Microtex needle 130/705 H-M 60-110	Especially sharp, narrow point	For micro fiber fabrics and silk.
	Quilting needle 130/705 H-Q 75, 90	Slightly rounded fine point	For straight and topstitching.

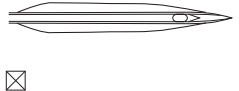
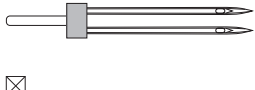
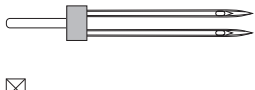
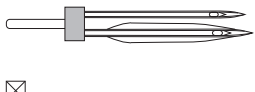
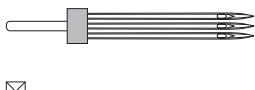
Illustration	Needle name	Needle description	Purpose
	Embroidery needle 130/705 H-E 75, 90	Small ball point, especially wide needle eye and wide thread groove	For embroidery on all natural and synthetic fabrics.
	Fine-material needle 130/705 H SES 70, 90	Small ball point	For fine knitware and knitted materials. For embroidery on fine, delicate fabrics.
	Metafil needle 130/705 H METAFIL 80	Long needle eye (2 mm) in all needle sizes	For sewing or embroidering with metallic threads.
	Cordonnet needle (to patch embroidery) 130/705 H-N 70-100	Long needle eye (2 mm) in all needle sizes	Topstitching with thick thread.
	Felt needle PUNCH	Needle with barbed hook	For felt work.
	Hemstitch needle 130/705 H WING 100-120	Wing-like widened needle shaft (wing)	To sew blind stitches.
	Universal double needle 130/705 H ZWI 70-100	Needle distance: 1.0/1.6/2.0/2.5/3.0/4.0/6.0/8.0	For visible hems in stretch fabrics, pintucks, decorative sewing.
	Stretch double needle 130/705 H-S ZWI 75	Needle distance: 2.5/4.0	For visible hems in stretch fabrics, pintucks, decorative sewing.
	Hemstitch double needle 130/705 H ZWIHO 100	Needle distance: 2.5	For special effects with hemstitch embroidery.
	Universal triple needle 130/705 H DRI 80	Needle distance: 3.0	For visible hems in stretch fabrics, decorative sewing.

Example for needle description

The 130/705 system, which is the most common for household machines, is explained by the following picture of a Jersey/Stretch needle.

	<p>130/705 H-S/70</p> <p>130 = Shank length (1)</p> <p>705 = Flat shank (2)</p> <p>H = Needle scarf (3)</p> <p>S = Needle point (here medium ball point) (4)</p> <p>70 = Needle size 0.7 mm (5)</p>
--	---

Thread selection

For a perfect sewing result, thread and fabric quality play an important role.

We recommend purchasing quality threads to achieve good sewing results.

- Cotton threads have the advantage of being a natural fiber and therefore are especially suitable for sewing cotton fabrics.
- Mercerized cotton threads have a slight sheen that is not lost with washing.
- Polyester threads have a high tensile strength and is particularly colorfast.
- Polyester threads are more flexible and are recommended where a strong and elastic seam is required.
- Rayon threads are made of natural fibers and have a brilliant sheen.
- Rayon threads are suitable for decorative stitches and achieve a more beautiful effect.

Needle/thread combination

	<p>The needle/thread combination is correct, when the thread fits perfectly into the long groove and goes easily through the needle eye. The thread can be optimally sewn.</p>
	<p>The thread can break and cause skipped stitches if there is too much play in the long groove or eye of the needle.</p>
	<p>The thread can break and become jammed if it frays on the edges of the long groove and is not guided optimally through the eye of the needle.</p>

2 Sewing preparation

2.1 Connection and Switching on

Connecting the machine

- > Insert the power cable into the power cord connection.



- > Insert the power cable into the power cord connection.

Use of the power cable (only USA/Canada)

The machine has a polarized plug (one contact is wider than the other). To reduce the risk of electric shock, the plug can only be plugged into the socket in one way. If the plug does not fit into the socket, turn the plug. If it still does not fit, contact an electrician to install an appropriate outlet. Do not modify the plug in any way.

Connecting the foot control



- > Insert the cable of the foot control into the foot control connection.



Attaching the knee lifter of the Free Hand System

The presser foot may be raised and lowered with the Free Hand System. The knee lifter is extremely helpful when sewing appliqué, patchwork and quilting since it allows you to handle the fabric while your knee controls the presser foot.

- > Insert the knee lifter into the opening at the front side of the machine.
- > Adjust the sitting height so that the knee lifter can be operated with the knee.



Switching the machine on

- > Switch on the machine at the main switch to «I».



Fixing the touchscreen pen

- > Store the touchscreen pen on the top holder.

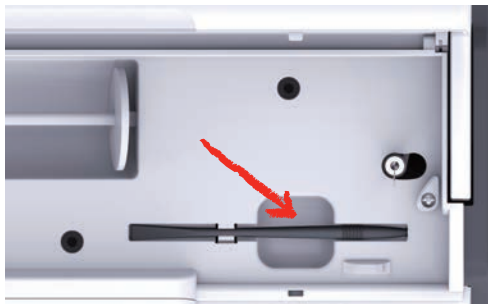

Regulating the speed via the foot control

Via the foot control the speed can be adjusted infinitely variable.

- > Press the foot control down carefully to start the machine.
- > To sew faster, press the foot control harder.
- > Release the foot control to stop the machine.



Raising/Lowering the needle

- > Sink the heel back on the foot control to raise/lower the needle.



Programming the foot control individually

The foot control can be programmed individually.

2.2 Spool pin

Horizontal spool pin

Placing the thread spool and the thread disc

Spool discs hold the thread spool in place for proper release of thread from the spool. The thread disc is only used with the horizontal spool holder.

- > Place the thread spool on the spool holder.
- > Position the appropriate spool disc on the spool holder so that there is no space between the spool disc and the thread spool.

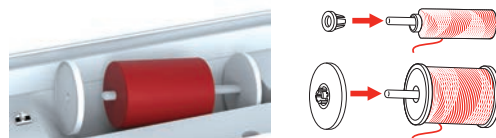

Using a spool net

The spool net provides an even unwinding of the thread from the thread spool and prevents the thread from knotting and breaking. The spool net is only used with the horizontal spool holder.

- > Pull the spool net over the thread spool.

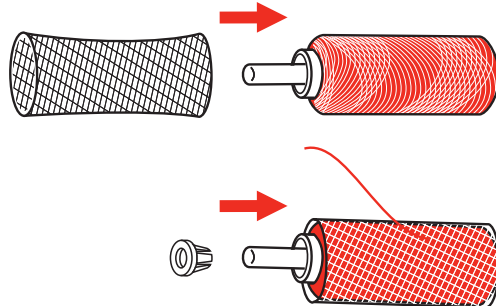

Second spool pin

Installing the second spool pin

The second spool pin is necessary when several threads are sewn.

- > Insert the second spool pin onto the end of the bobbin winding unit(1).
- > Align the notch (2) with the spring (3) on the bobbin winding unit.

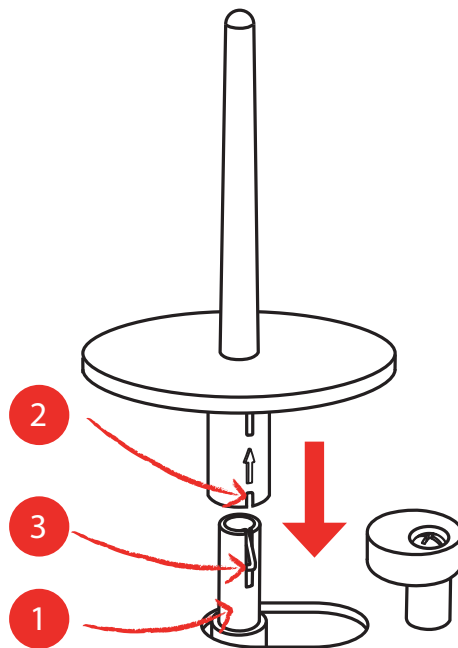

Inserting thread spool

The felt disc prevents the thread from getting hooked at the second spool pin.

- > Place the felt disc (1) on the second spool pin.

- > Place the thread spool on the second spool pin.

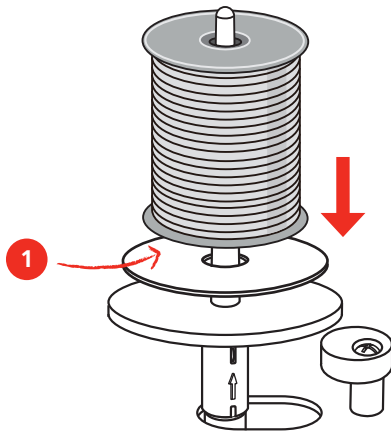

2.3 Free arm

The bernette b77 provides a solidly designed free arm which offers a lot of space for large project on the right of the needle.

2.4 Sewing table and accessory box

The sewing table is used as an accessory box.

- > To remove the sewing table, hold the sewing table by the handle on the left and pull in the direction of the arrow.



- > To open the accessory box, tilt the cover towards you.
- > To close the accessory box, tilt the cover backwards until it clicks into place.

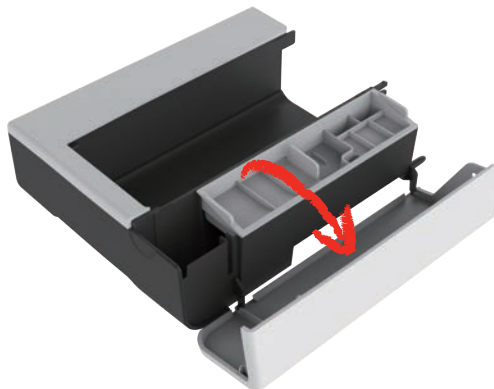

2.5 Raising or Lowering the Feed dog

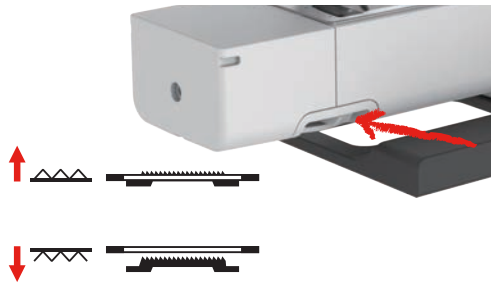

- > To raise the feed dog, push the feed dog lever to the right.
 - The feed dog is raised when the first stitch is sewn.
- > Slide the «Feed dog lever» left to lower the feed dog.
 - The feed dog is lowered.

2.6 Using the slide-on table

When attached to the free arm, it expands the already existing sewing area.

- > Raise the needle.
- > Raise the presser foot.
- > Switch the machine off and disconnect it from the power supply system.
- > Push the slide-on table to the right over the free arm until it engages.



- > To remove the slide-on table, pull the slide-on table over the free arm to the left.



2.7 Presser foot

Adjusting the presser position via the knee lifter of the Free Hand System

- > Adjust the sitting height so that the knee lifter can be operated with the knee.
- > Push the knee lifter with the knee to the right to raise the presser foot.



- Simultaneously the thread tension is released.
- > Release the knee lifter slowly to lower the presser foot.

Changing the presser foot sole

Removing the presser foot sole

- > Raise the presser foot.
- > Press down on the front of the presser foot sole by hand.

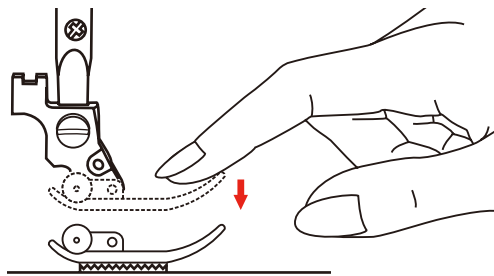

Attaching the presser foot sole

- > Raise the presser foot (1).
- > Place the presser foot sole (2) under the shaft groove (3) so that the shaft groove is above the presser foot sole pin (4).
- > Then push the new presser foot sole upward until it engages.

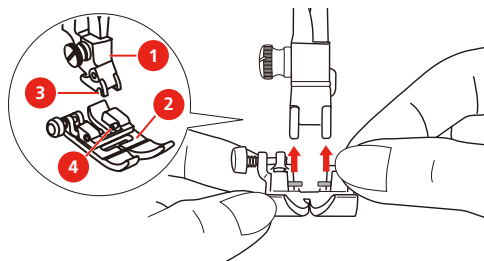

Removing and inserting the presser foot holder

- > Raise the presser foot.
- > Align the presser foot holder (1) with the lower left side of the presser bar (2).
- > Hold the presser foot holder and drive the screw in manually.

- > Tighten the screw with the screwdriver.

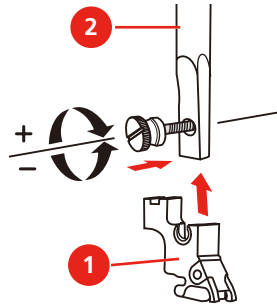

Inserting the edge/ quilting guide

The seam guide is suitable for sewing parallel lines.

- > Insert the edge/quilting guide (1) in the slot (2).
- > Adjust the width as desired.

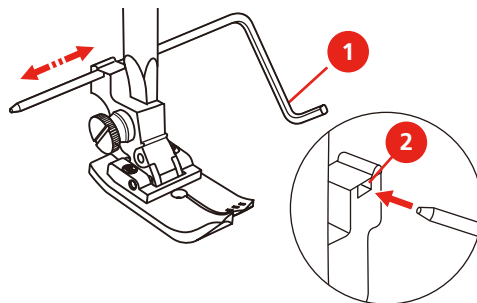

Having the presser foot sole displayed in the user interface

The recommended presser foot sole for the selected stitch is displayed. Moreover, other optimal presser foot soles can be displayed.

- > Switch the machine on.
- > Select the stitch pattern.
 - In the icon «Presser foot sole display» the recommended presser foot sole is indicated with a letter.
- > Touch the icon «Presser foot sole display».
 - Any presser foot soles are displayed.



- A green tick indicates the recommended presser foot sole.
- A yellow star indicates the presser foot soles which can also be used for this stitch for special purposes.

Selecting the needle in the User Interface

After changing the stitch plate, you can check whether it can be used with the selected needle.



- > Touch the icon «Needle selection» or «Stitch plate selection».
- > Select the attached needle.

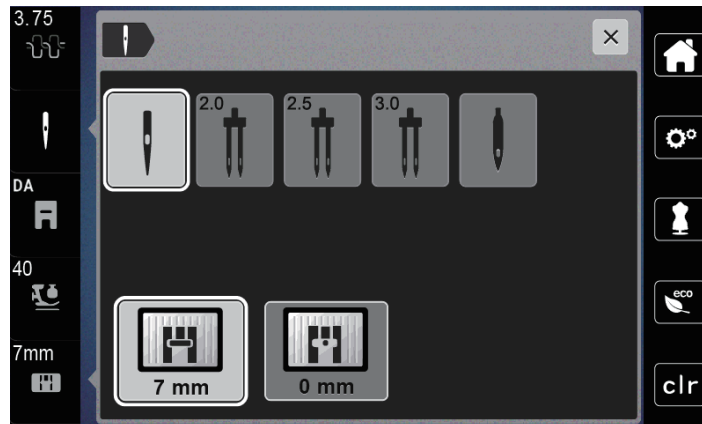

- When the selected needle matches the selected stitch plate and the presser foot, sewing can be started.
- If the selected needle does not match the stitch plate, a red exclamation mark appears.

Needle stop up/down (permanent)



- > Touch the icon «Needle stop up/down (permanent)» to fix the needle position permanently.
 - The machine stops with needle position down as soon as the foot control is released or the button «Start/Stop» has been pressed.
- > Touch the icon «Needle stop up/down (permanent)» again.
 - The machine stops with needle position up as soon as the foot control is released or the button «Start/Stop» has been pressed.

Changing the stitch plate

The stitch plate is marked with vertical, horizontal and diagonal lines in millimeters (mm) and inches (inch). These markings are helpful when sewing or for precise topstitching. **Please note:** The markings of the bobbin case and the stitch plate must be aligned identically.

Prerequisite:

- The feed dog is lowered.
 - The machine is switched off and disconnected from the power supply system.
 - The bobbin cover, the needle and the presser foot are removed.
- > Remove the screws of the stitch plate with the screwdriver.

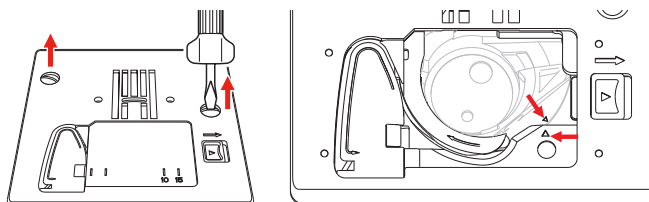

- > Remove the stitch plate.
- > Position new stitch plate and tighten screws with screwdriver.

Checking the stitch plate in the user interface

After changing the stitch plate, you can check whether it can be used with the selected needle.



- > Press the Icon «Needle selection» or «Stitch plate selection».
 - The mounted needle plate is automatically detected and shown in the display.

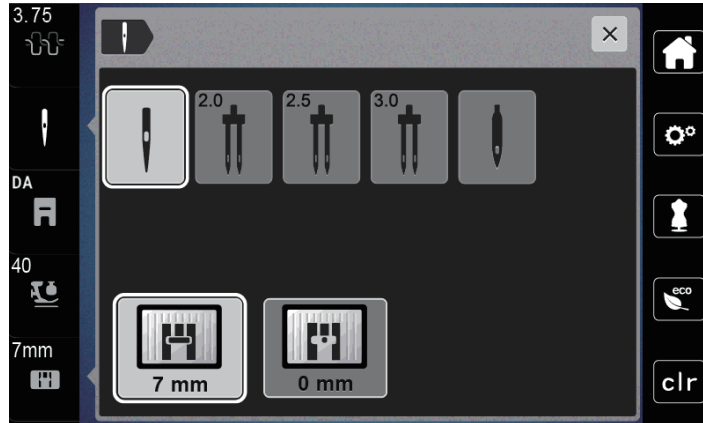

- If the selected stitch plate is suitable for use with the needle, sewing may begin.
- The stitch width is automatically set to the permissible value.
- If the selected throat plate is unsuitable for use with the needle, a red exclamation mark appears.

2.9 Threading

Threading preparation

- > Press the button «Presser foot up/down» to raise the presser foot.
- > Raise the presser foot.

Threading the upper thread

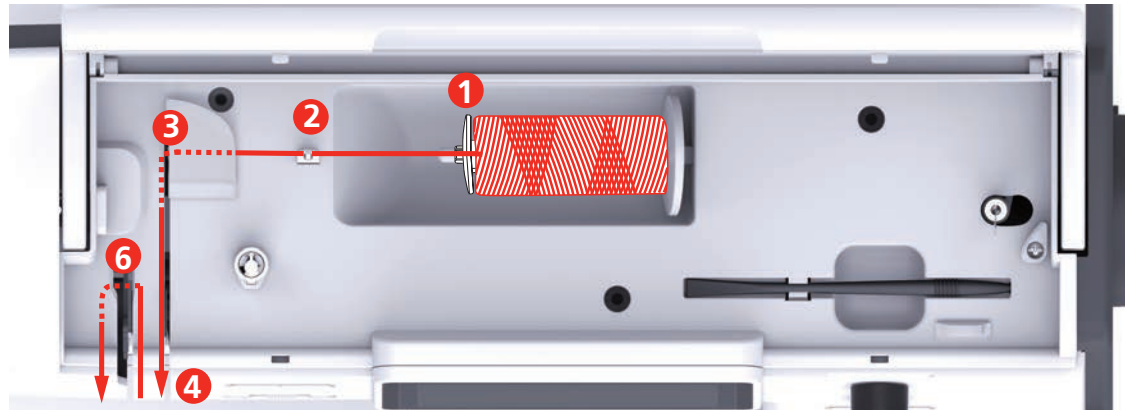

- | | | | |
|---|----------------------------|----|----------------|
| 1 | Spool disc | 7 | Guide |
| 2 | Thread guide | 8 | Guide |
| 3 | Thread guide | 9 | Threader lever |
| 4 | Thread tension discs | 10 | Wire hook |
| 5 | Thread take-up lever cover | 11 | Thread cutter |
| 6 | Thread take-up lever | 12 | Thread |

- > Place the thread spool on the spool pin so that the thread is unwound clockwise.
- > Attach the appropriate thread disc.
- > Feed the thread through the thread guide (2).

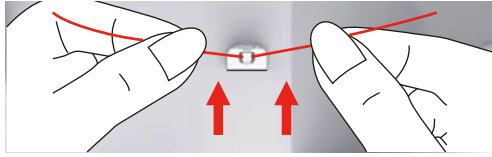

- > Feed the thread through the thread guide (3).



- > Place the end of the thread down along the duct.



- > Guide the thread downwards around the thread take-up lever cover.

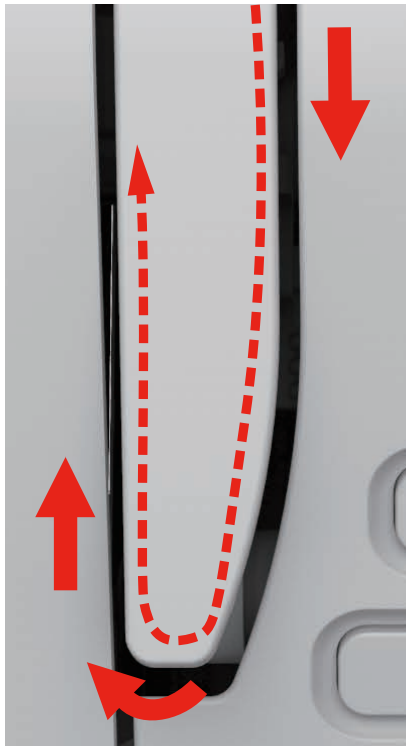

- > Guide the thread at the top from right to left through the thread take-up lever and then down again.

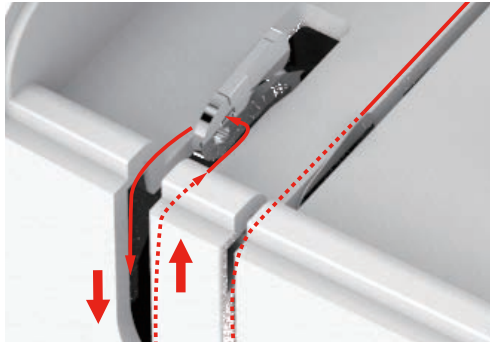

- > Pass the thread through the guides above the presser foot.
- > Lower the presser foot.

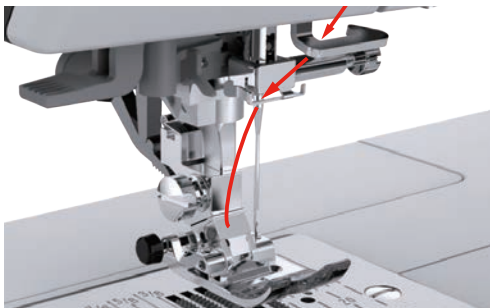

- > Press the threading lever down until it clicks into place.
 - The wire hook goes through the eye of the needle.
 - To prevent damage to the threader, the presser foot is lowered automatically.

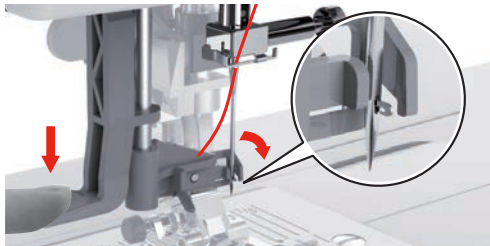

- > Feed the thread around the thread guide.
- > Bring the thread to the needle and below the wire hook.

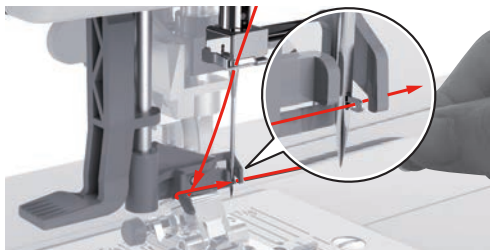

- > To cut off excess thread, take the thread end and pull it over the thread cutter. **Please note:** Use the right thread cutter only when threading.

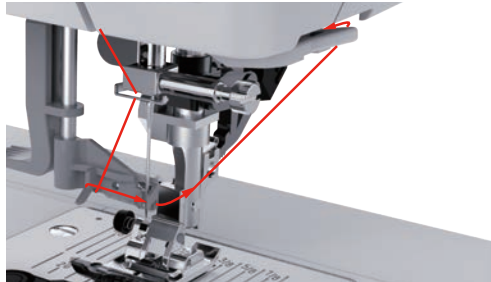
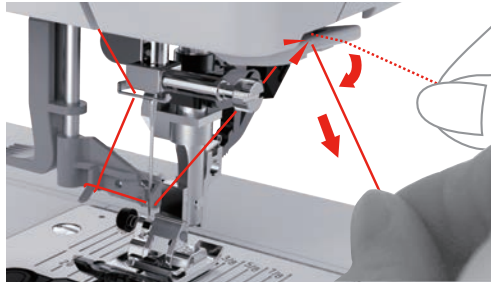

- > To thread the thread into the needle, raise the threading lever.
 - The wire hook retracts and guides the thread through the eye of the needle where it forms a loop.
- > Pull the thread completely through the eye of the needle.

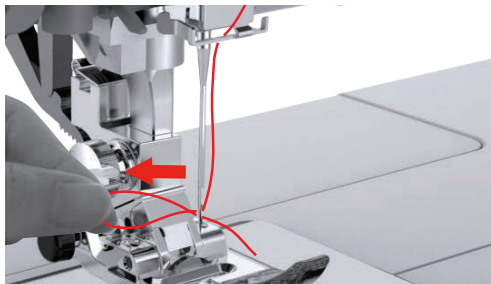

Threading the double needle

Prerequisite:

- The double needle is inserted.
- The second spool pin, felt disc and thread spool are installed.
- > Guide the first thread in the direction of the arrow on the left side of the thread tension disc (1).
- > Guide the second thread in the direction of the arrow on the right side of the thread tension disc (1).

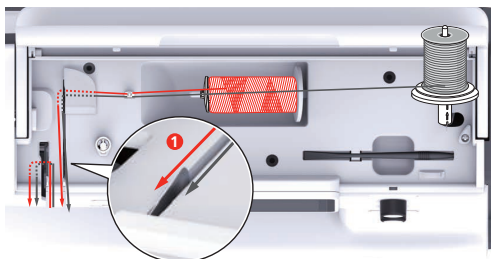

- > Guide the first and the second thread to the thread guide above the needle.
- > Thread the first thread manually into the right needle.

- > Thread the second thread manually into the left needle.

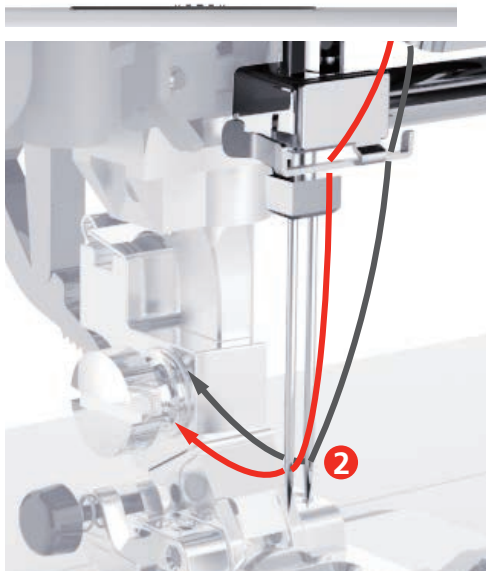

Winding the bobbin thread

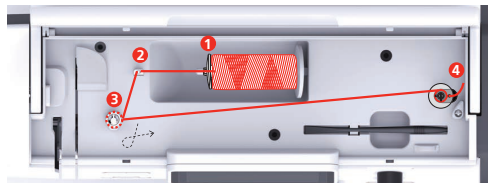

- | | |
|----------------|---------------------|
| 1 Spool disc | 3 Thread pretension |
| 2 Thread guide | 4 Spool pin |

- > Place the thread spool and the appropriate spool disc on the spool holder.
- > For smaller thread spools, use the small thread disc.

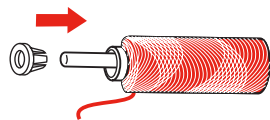

- > To prevent tangling or tearing of the thread, use the spool net.

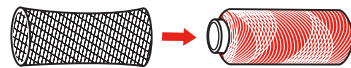

- > Feed the thread through the thread guide.

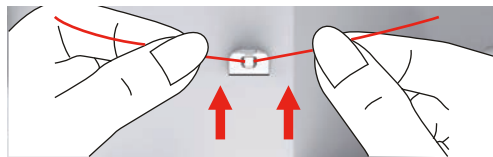

- > Wind the thread clockwise around the thread pre-tensions.

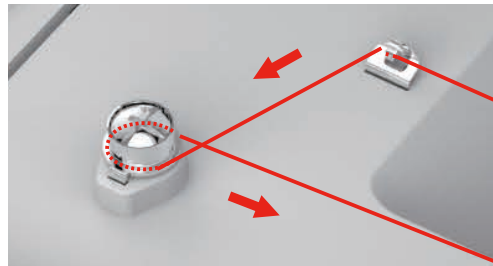

- > Pull the thread end through one of the inner holes of the bobbin and place the empty bobbin on the bobbin unit.

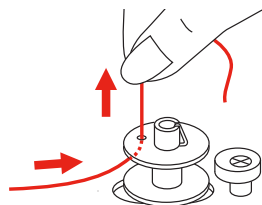

- > Push the bobbin to the right.



- The button «Start/Stop» flashes and the display for winding appears.



- > Hold the end of the thread with one hand.
- > To start the winding process for a few rotations and then stop, push the button «Start/Stop», so that the thread is held tight on the bobbin.
- > Cut off the thread end next to the inner hole.

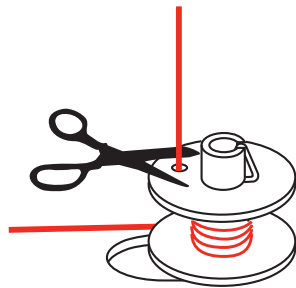

- > To continue the winding process, push the button «Start/Stop».
- > To stop the winding process, push the button «Start/Stop».
- > Remove the bobbin and cut the thread.

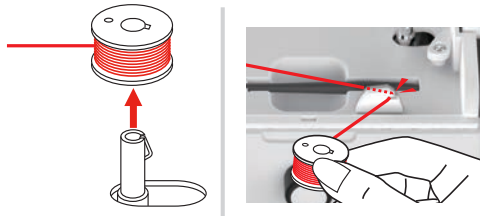

Threading the bobbin thread

Prerequisite:

- The needle is raised.
 - The presser foot is raised.
 - The machine is switched off.
- > Open the bobbin cover by pushing the release button to the right.

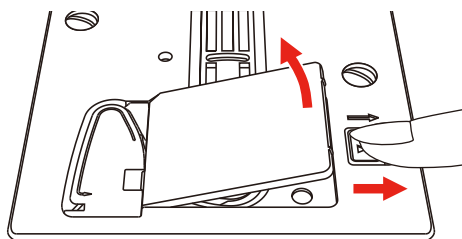

- > Insert the new spool so that the thread is wound in the counterclockwise direction.

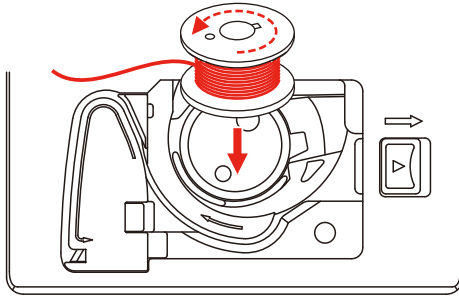

- > Pull the thread into the slit (1).

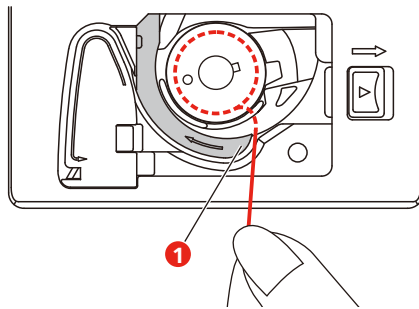

- > Press gently on the bobbin.
- > Follow the arrow markings to bring the thread into the bobbin thread guide.

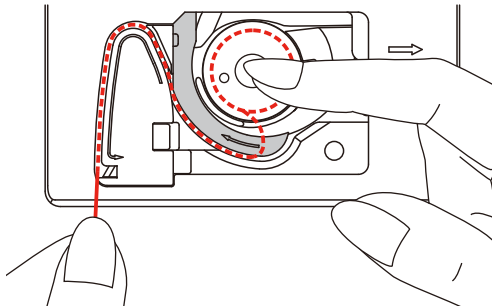

- > To cut off excess thread, take the thread end and pull it over the thread cutter (2).

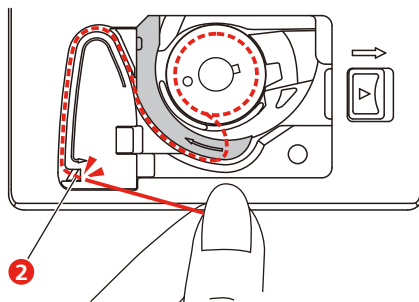

- > Close the bobbin cover.

3 Setup Program

3.1 Sewing settings

Adjusting the upper thread tension

Adjustments to the upper thread tension in the Setup Program affect all stitch patterns. Individual alteration of the upper thread tension can also be made for currently selected stitches.



> Touch the icon «Setup Program».



> Touch the icon «Sewing settings».



> Touch the icon «Alter the upper thread tension».

> Move the slide using the touchscreen pen/finger or touch the icons «+» or «-» to alter the upper thread tension.

Adjusting the maximum sewing speed

By using this function, the maximum speed can be reduced.



> Touch the icon «Setup Program».



> Touch the icon «Sewing settings».



> Touch the icon «Alter the maximum speed».

> Move the slide using the touchscreen pen/finger or touch the icons «+» or «-» to alter the maximum speed.

Programming the securing stitches

If the function is activated, 4 securing stitches are sewn automatically at the pattern start after the thread cut.



> Touch the icon «Setup Program».



> Touch the icon «Sewing settings».



> Touch the switch using the touchscreen pen/finger to deactivate the securing stitches.

> Touch the switch again to activate the securing stitches.

Adjusting the hovering height of the presser foot

The hovering height of the presser foot can be adjusted according to the fabric thickness from 1 to maximal 6 mm.



> Touch the icon «Setup Program».



> Touch the icon «Sewing settings».



> Touch the icon «Program buttons and icons». Touch the switch again to deactivate the presser foot raised to hovering position with needle stop down.



> Touch the icon «Program the hovering position of the presser foot».
> Turn the «Upper Multifunction knob» or the «Lower Multifunction knob» or touch the icons «-» or «+» to adjust the distance between the stitch plate and the presser foot.

Programming the button «Securing»

Number and type of securing stitches can be programmed.

The number of securing stitches for practical stitches can be programmed in the upper section of the display (1).

Securing of decorative stitches or stitch pattern combinations can be programmed in the lower section of the display (2).

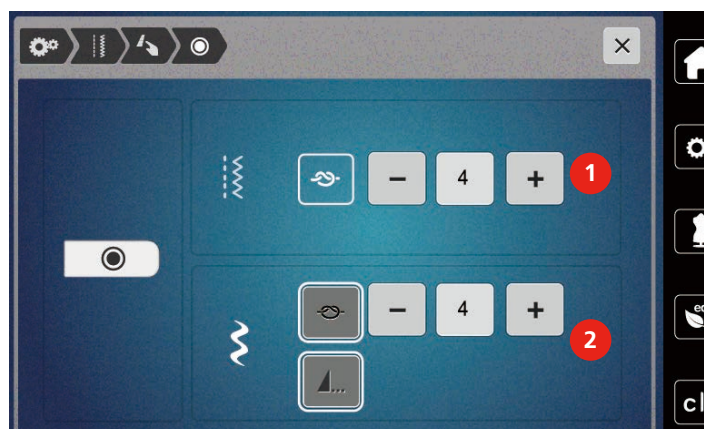

> Touch the icon «Setup Program».



> Touch the icon «Sewing settings».



> Touch the icon «Program buttons and icons».



> Touch the icon «Program securing».
> Touch the icons «-» or «+» in the upper section of the display (1) to program the number of securing stitches in close succession for practical stitches.



- > Touch the icon «Securing» to activate automatic securing for decorative stitches and combined stitches.
- > Touch the icons «-» or «+» in the lower section of the display (2) to program the number of securing stitches in close succession.
- > Touch the icon «Securing» again to deactivate automatic securing for decorative stitches and combined stitches.



- > To secure the selected pattern at the end, touch the icon «Pattern end».
– The machine secures and stops at the end of the pattern.
- > To deactivate securing at the end of the pattern, touch the icon «Pattern end» again.

Programming the button «Thread cutter»

The automatic securing can be programmed before the thread cut takes place.



- > Touch the icon «Setup Program».



- > Touch the icon «Sewing settings».



- > Touch the icon «Program buttons and icons».



- > Touch the icon «Program the button thread cutter».



- > Touch the icon «Securing» to activate 4 securing stitches before cutting.
- > Touch the icons «-» or «+» to program the number of securing stitches.
- > Touch the icon «Securing» again to deactivate the automatic securing.

Adjusting the presser foot position with needle stop down

With lowered needle, the presser foot is raised to hovering position when the needle is programmed in the down position.



- > Touch the icon «Setup Program».



- > Touch the icon «Sewing settings».



- > Touch the icon «Program buttons and icons». Touch the switch again to deactivate the presser foot raised to hovering position with needle stop down.



- > Touch the icon «Adjust the presser foot position with needle stop down».



- > Touch the switch to activate the presser foot raised to hovering position with needle stop down.
- > Touch the switch again to deactivate the presser foot raised to hovering position with needle stop down.

Programming the button «Quick reverse»

It can be chosen either «Reverse sewing» or «Backstepping».



> Touch the icon «Setup Program».



> Touch the icon «Sewing settings».



> Touch the icon «Program buttons and icons». Touch the switch again to deactivate the presser foot raised to hovering position with needle stop down.



> Touch the icon «Program Quick reverse».



> Touch the icon «Backstepping» to activate backstepping.

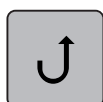

> Touch the icon «Backstepping» to activate backstepping.

Programming the foot control individually

When the icon «Needle up/down» is activated, the needle is raised or lowered via a back kick on the foot control. Alternatively, the presser foot can be positioned, the thread can be cut and the automatic securing can be programmed.



> Touch the icon «Setup Program».



> Touch the icon «Sewing settings».



> Touch the icon «Program the foot control».

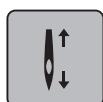

- The icon «Needle up/down» is activated by default.
- The back kick on the foot control raises or lowers the needle.



> Touch the icon «Program the back kick» to program the back kick.



- > Touch the icon «Securing» to activate the automatic securing via the back kick.
- > Touch the icons «-» or «+» to program the number of securing stitches.
- > Touch the icon «Securing» again to deactivate the automatic securing via the back kick.



- > Touch the icon «Cut thread» to activate the automatic thread cut via the back kick.
- > Touch the icon «Cut thread» again to deactivate the thread cut via a back kick on the foot control.



- > Touch the icon «Position the presser foot» so that the presser foot remains down via the back kick.
- > Touch the icon «Position the presser foot» again so that the presser foot remains up via the back kick.
 - If only «Position the presser foot »is activated without «Cut thread» and «Securing», the function can move presser foot to hovering position or highest position (12 mm).

Fabric thickness measurement

While sewing, the machine continuously checks the current fabric thickness and adjusts a proper presser foot pressure in time to keep a smooth feed of the fabric.



- > Touch the icon «Setup Program».



- > Touch the icon «Sewing settings».



- > To activate the automatic compensation of the presser foot pressure, touch the icon «Fabric thickness measurement».
- > To deactivate the automatic compensation of the presser foot pressure, touch the icon «Fabric thickness measurement» again.

Adjusting the general balance

Different fabrics, threads and stabilizers can affect the programmed stitch patterns so that they cannot be sewn out correctly. The electronic balance can correct these deviation and the stitch pattern can be adjusted optimally to the selected fabric.

- > Select a stitch pattern or alphabet.
- > Touch the icon "Setup Program".



- > Touch the icon "Sewing settings".



- > Touch the icon "Balance".
 - A preview of the stitch pattern is displayed.
- > To correct the longitudinal direction of the stitch pattern, turn the «Multifunction knob» until the preview of the stitch pattern matches the stitch pattern sewn on the fabric.



3.2 Selecting personal settings



- > Touch the icon «Setup Program».



- > Touch the icon «Personal settings».
- > Select the desired display color.

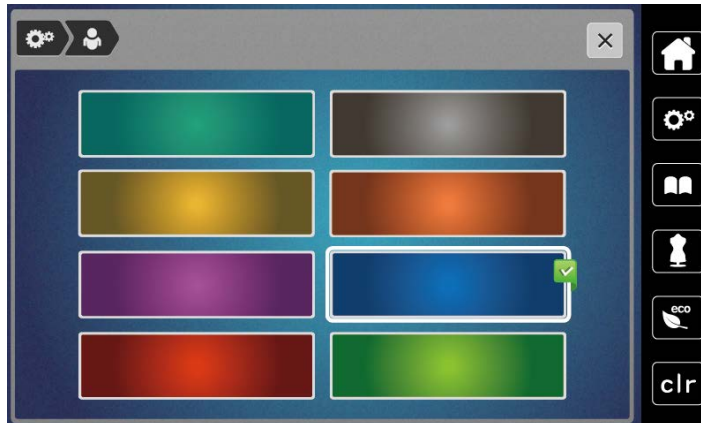

3.3 Monitoring functions

Activating the upper thread indicator



- > Touch the icon «Setup Program».



- > Touch the icon «Monitoring settings».



- > Touch the switch in the upper portion of the display to deactivate the upper thread indicator.
- > Touch the switch again to activate the upper thread indicator.

Activating the bobbin thread indicator



- > Touch the icon «Setup Program».



- > Touch the icon «Monitoring settings».



- > Touch the switch in the lower section of the display to deactivate the bobbin thread indicator.
- > Touch the switch again to activate the bobbin thread indicator.

3.4 Sound on/off



- > Touch the icon «Setup Program».



- > Touch the icon «Sound on/off» to deactivate any audio signals in general.
- > Touch the icon «Sound on/off» again to deactivate any audio signals in general.

3.5 Machine settings

Adjusting the brightness of the display

The brightness of the display can be adjusted corresponding to the personal preferences.



- > Touch the icon «Setup Program».



- > Touch the icon «Machine settings».



- > Touch the icon «Adjust the brightness».
- > Move the slide in the upper portion of the display using the touchscreen pen/finger or touch the icons «+» or «-» to alter the brightness of the display.

Adjusting the sewing light

The brightness of the sewing light can be adjusted corresponding to the personal preferences.



- > Touch the icon «Setup Program».



- > Touch the icon «Machine settings».



- > Touch the icon «Adjust the brightness».
- > Move the slide in the upper portion of the display using the touchscreen pen/finger or touch the icons «+» or «-» to alter the brightness of the sewing light.



- > Touch the switch to switch the sewing light off.
- > Touch the switch again to switch the sewing light on.

Calibrating the display

Please find further information on this topic in the chapter attachment below troubleshooting at the end of the instruction manual.



- > Touch the icon «Setup Program».



- > Touch the icon «Machine settings».



- > Touch the icon «Calibrate the display».
- > Touch the crosses in sequence using the touchscreen pen.

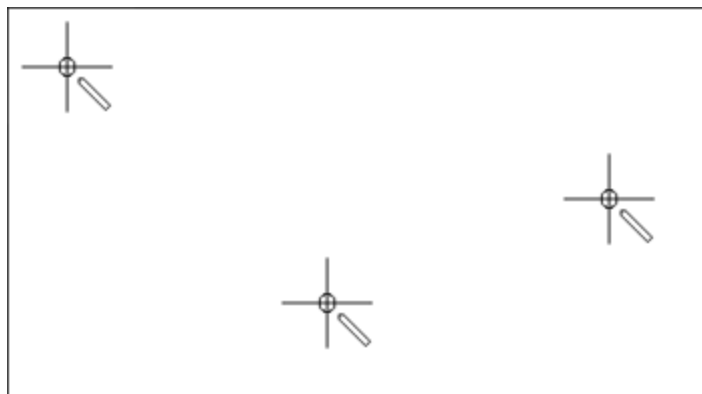

Back to basic settings

WARNING: Using this function will delete all individually made settings.



- > Touch the icon «Setup Program».



- > Touch the icon «Machine settings».



- > Touch the icon «Default settings».



- > Touch the icon «Confirm» to restore the default settings for sewing.



- > Touch the icon «Default setting all».



- > Touch the icon «Confirm» and restart the machine to restore all default settings.

Checking the firmware version

The firmware version of the machine is displayed.



- > Touch the icon «Setup Program».



- > Touch the icon «Machine settings».



- > Touch the icon «Firmware version».

Reviewing the total number of stitches

The total stitch count of the machine and the number of stitches since the last service performed by a bernette dealer are displayed.



4,000,000 stitches after a service, the symbol indicates that it is recommended to have the machine serviced by a bernette dealer.



> Touch the icon «Setup Program».



> Touch the icon «Machine settings».



> Touch the icon «Firmware version».

4 System settings

4.1 Using eco mode

During a longer interruption of work the machine can be set into a power save mode. Nothing can be selected in the display and the machine cannot be started.



- > Touch the icon «eco» again.
 - The display goes to sleep. The power consumption is reduced and the sewing light is off.

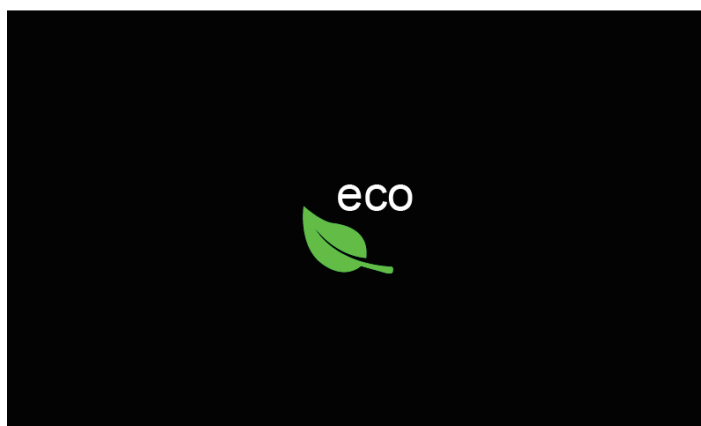

- > Quickly click the green icon «eco» on the screen.
 - The machine is ready for use.

4.2 Calling up the Creative Consultant

The Creative Consultant provides information about decision support concerning sewing projects. After entering the fabric and the desired sewing project, suggestions for suitable needles, presser feet etc. are displayed.



- > Touch the icon «Creative Consultant».
- > Select the fabric to be sewn.



- | | | | |
|---|---------------------|----|-----------------------------|
| 1 | Light-weight woven | 7 | Heavy knits |
| 2 | Medium-weight woven | 8 | Fake fur/coated fake fur |
| 3 | Heavy-weight woven | 9 | Toweling |
| 4 | Jeans | 10 | Fabric with a piled texture |
| 5 | Light knits | 11 | Leather and vinyl |
| 6 | Medium-weight knits | 12 | Net and Lace |

- > Select the sewing project.
 - The stitch is changed automatically, but all other settings must be done by the user.

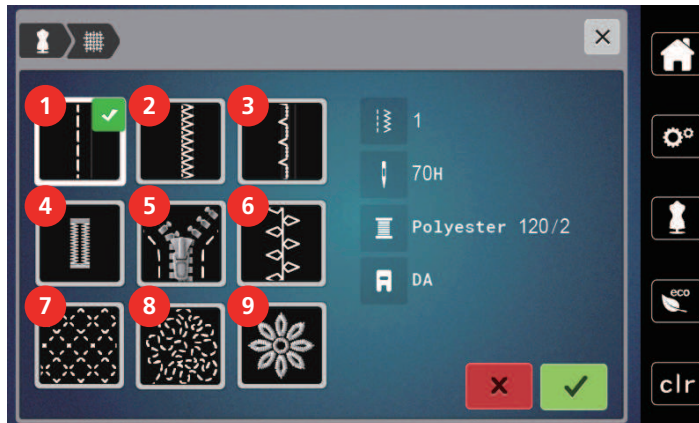

- | | | | |
|---|-----------------|---|--------------------|
| 1 | Seams | 6 | Creative sewing |
| 2 | Finishing edges | 7 | Machine quilting |
| 3 | Blindstitch hem | 8 | Free motion sewing |
| 4 | Buttonholes | 9 | Appliqués |
| 5 | Zippers | | |

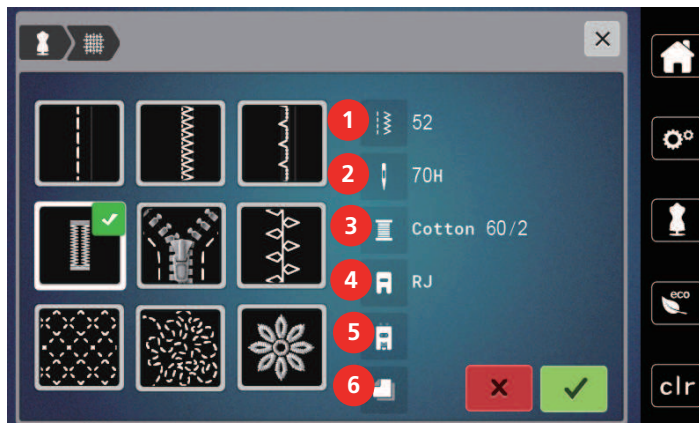

- | | | | |
|---|---------------------------|---|--------------------------|
| 1 | Recommended stitch number | 4 | Recommended presser foot |
| 2 | Recommended needle | 5 | Reinforced buttonhole |
| 3 | Recommended thread | 6 | Stabilizer recommended |

- > Make the settings of the machine according to the instructions.

4.3 Cancelling any alterations with «clr»

Any alterations to motifs can be reset to default setting. Exceptions are saved motifs which have been filed in the personal memory and monitoring functions.



- > Touch the icon «clr».

5 Creative sewing

5.1 Overview selection menu sewing

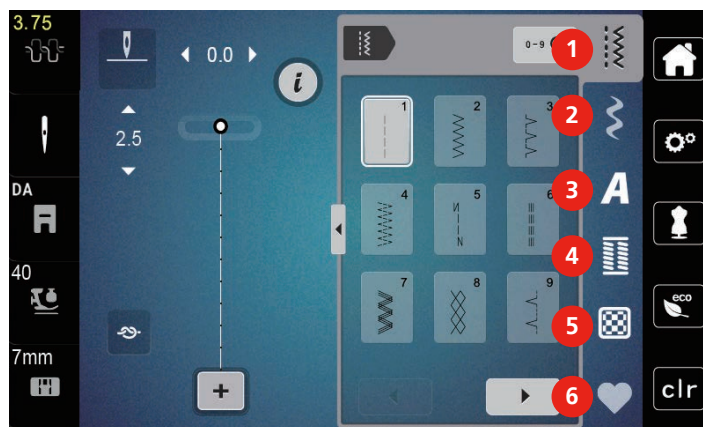

- | | | | |
|---|---------------------|---|-----------------|
| 1 | Practical stitches | 4 | Buttonholes |
| 2 | Decorative stitches | 5 | Quilt stitches |
| 3 | Alphabets | 6 | Personal Memory |

Selecting a stitch pattern

- > Select a stitch pattern, an alphabet or a buttonhole.
- > Touch the icon «Scrolling» (1) to have more stitch patterns displayed.
- > Touch the icon «Display all the stitch patterns» (2) to scale up the view.
- > Touch the icon «Display all the stitch patterns» (2) again to downsize the stitch pattern view.
- > Touch the icon «Stitch pattern number entry» (3) to select the stitch pattern via entering the stitch number.
 - If «!!!» appear when entering the stitch pattern, the stitch pattern cannot be used in the Combi mode.
 - If «???» appear when entering the stitch pattern, the stitch pattern doesn't exist.

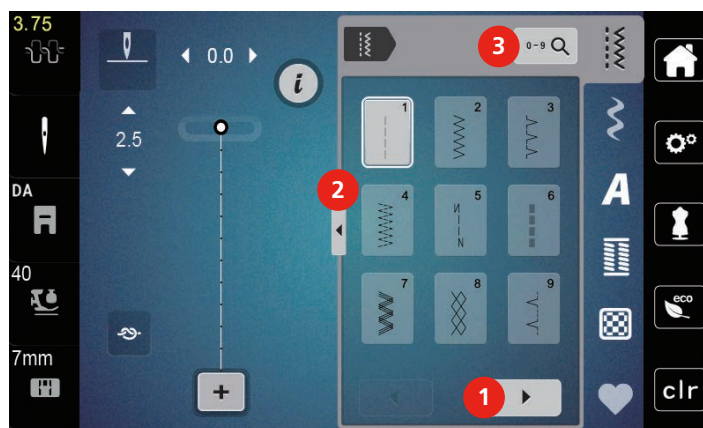
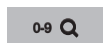

5.2 Dual Feed (DF)



It is recommended to match the presser foot pressure with the fabric. The thicker the fabric, the lower the presser foot pressure.

The Dual Feed feeds the fabric from above and from beneath simultaneously. This provides an even and careful feed forward even for smooth and thin materials. Striped and checkered patterns can be matched perfectly by even feeding.

Application of the Dual Feed

In general, the Dual Feed is used for the following sewing projects:

- Sewing: All sewing applications with difficult fabrics such as for seams, zippers.
- Patchwork: With accurate stripes, blocks and with decorative stitches up to a stitch width of 7 mm.
- Appliqués: Sewing on ribbons and bias binding

Difficult-to-work-with fabrics are:

- Velvet, normally sewn with the grain
- Toweling
- Jersey, especially when sewing it crosswise to knit
- Fake fur or coated fake fur
- Fleece-types of fabrics
- Batted fabrics
- Stripes and checks
- Curtain fabrics with pattern repeats

«Sticky» fabrics are:

- Imitation leather, coated fabrics

Use the Dual Feed



Only use presser feet with the back opening when engaging the DF mechanism.

- > Raise the presser foot.
- > Swing the DF mechanism forward under the back of the presser foot until it clicks in position.

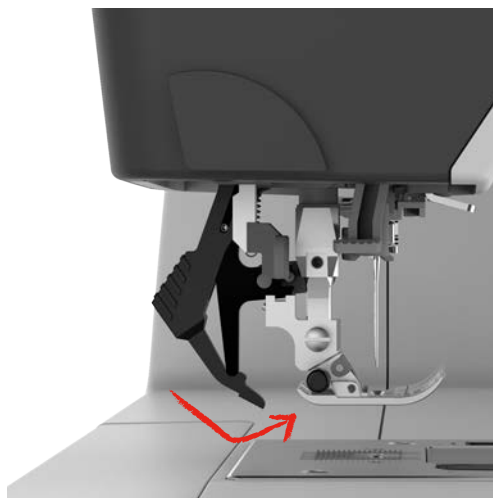

- > Raise the presser foot.
- > Pull down the DF mechanism and swing it to the rear to disengage.

5.3 Regulating the speed

The sewing speed can be adjusted infinitely variable with the slide.

- > Move the slide to the left to reduce the sewing speed.
- > Move the slide to the right to increase the sewing speed.

5.4 Adjusting the upper thread tension

Basic settings are applied automatically when a stitch pattern or program is selected.

When using different types of sewing threads, the optimal tension may vary. Therefore it may be necessary to adjust the upper thread tension according to the sewing project as well as the desired stitch pattern individually.

Alteration of the upper thread tension affect the currently selected stitch pattern or embroidery motif. Permanent alterations of the upper thread tension for the sewing can be made in the Setup Program.



- > Touch the icon «Upper thread tension».
- > Move the slider in the display using the touchscreen pen/finger to increase or reduce the upper thread tension.

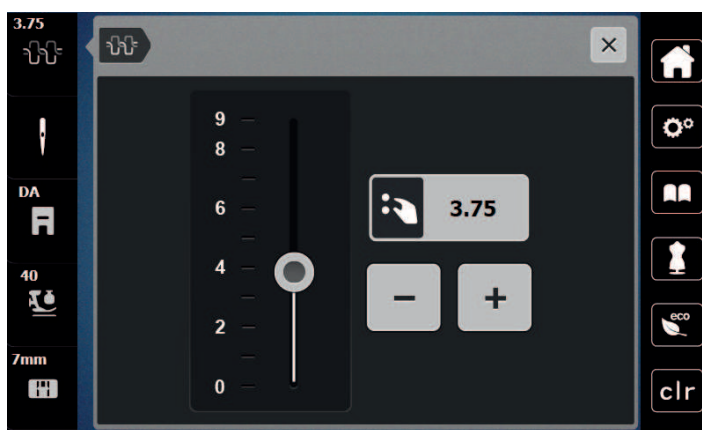

5.5 Editing stitch patterns

Changing the stitch width

- > Turn the «Upper Multifunction knob» to the left to narrow the stitch width.
- > Turn the «Upper Multifunction knob» to the right to widen the stitch width.
- > To call up further setting options, touch the icon «Stitch width» (1).

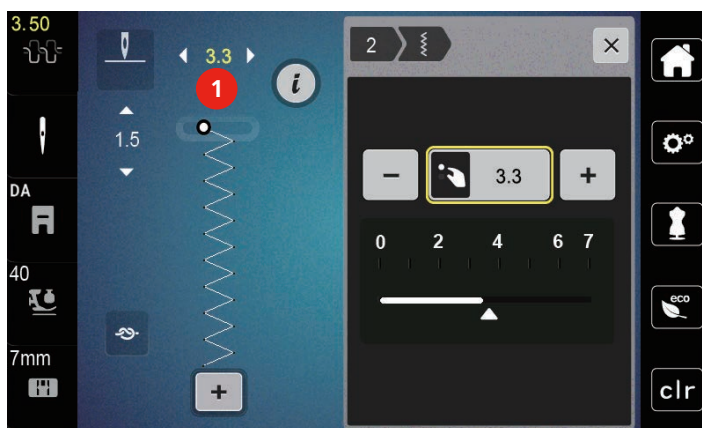

Changing the stitch length

- > Turn the «Lower Multifunction knob» to the left to shorten the stitch length.
- > Turn the «Lower Multifunction knob» to the right to elongate the stitch length.
- > To call up further setting options, touch the icon «Stitch length» (1).

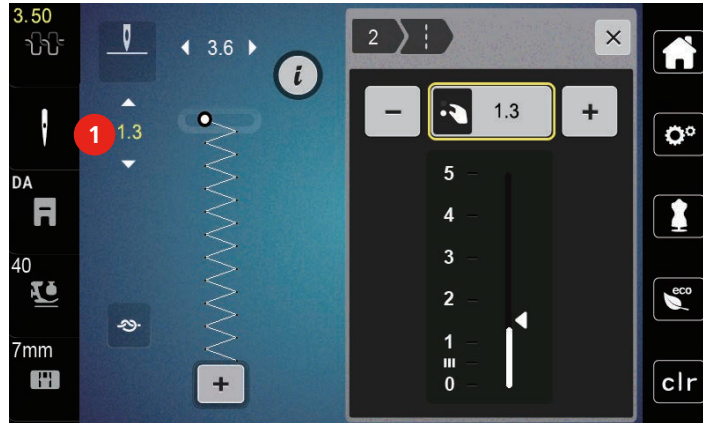

Correcting the balance

Different fabrics, threads and stabilizers can affect the programmed stitch patterns so that they cannot be sewn out correctly. The electronic balance can correct these deviation and the stitch pattern can be adjusted optimally to the selected fabric.

- > Select a stitch pattern or alphabet.
- > Sewing stitch pattern.
- > Touch the icon «i»-Dialog.



- > Touch the icon «Confirm».
 - A preview of the stitch pattern is displayed.

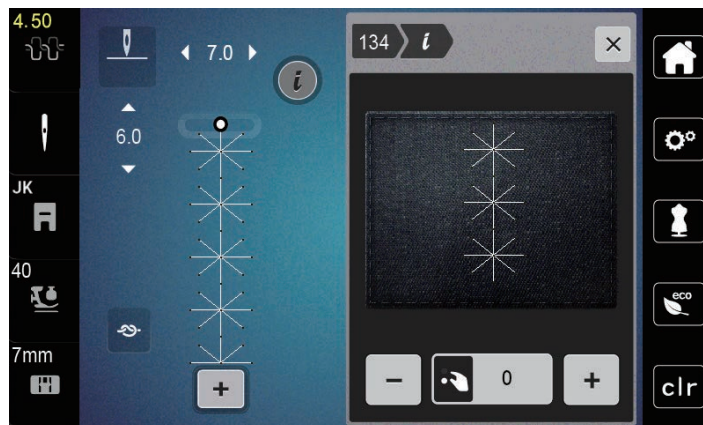

- > To correct the longitudinal direction of the stitch pattern, turn the «Lower Multifunction knob» until the preview of the stitch pattern matches the stitch pattern sewn on the fabric.
- > Altered balance settings can be saved for each stitch in the «Personal memory».
- > Altered balance settings only remain valid until the «clr button» is pressed or the machine is switched off.

Programming pattern repeat



- > Select a stitch pattern or alphabet.
- > Touch the icon «i»-Dialog.



- > Touch the icon «Pattern repeat» once to repeat the stitch pattern.
- > Touch the icon «Pattern repeat» twice up to 9 times to repeat the stitch pattern up to 9 times.
 - The machine stops automatically after the programmed number of patterns has been sewn.



- > To secure a step stitch at the sewing end, the icon «Securing» is activated.
- > Touch the icon «Securing» to deactivate the securing.

Mirror image of stitch patterns



- > Select a stitch pattern or alphabet.
- > Touch the icon «i»-Dialog.



- > Touch the icon «Mirror image left/right» to mirror the stitch pattern from left to right.



- > Touch the icon «Mirror image up/down» to mirror the stitch pattern contrary to the sewing direction.

Editing stitch pattern length

Stitches from category satin stitch pattern can be lengthwise extended or shortened.



- > Select a stitch pattern.
- > Touch the icon «i»-Dialog.



- > Touch the icon «Editing stitch pattern length».
- > Move the slide with or touch the «+»/«-» icons (1) to determine the length of the stitch pattern.
- > Touch the icons «+»/ «-» (2) to determine the density of the stitch pattern.

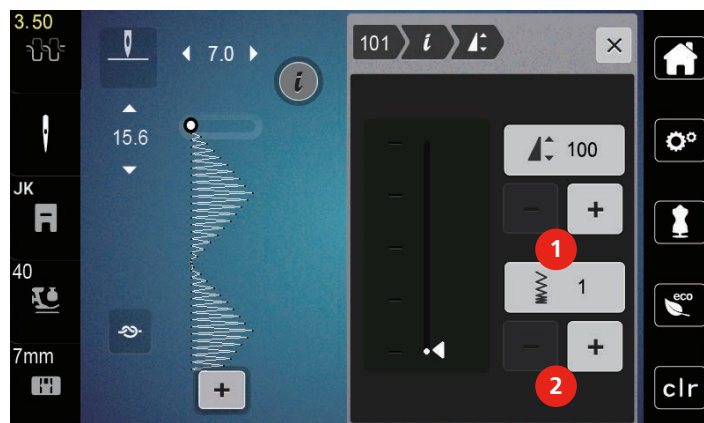

Permanent Quick reverse

- > Select a stitch pattern or alphabet.
- > Touch the icon «i»-Dialog.



- > Touch the icon «Permanent reverse sewing» (1) to sew permanently in reverse.

Backstepping

- > Select a stitch pattern, alphabet or buttonhole.
- > Touch the icon «i»-Dialog.
- > Touch the icon «Backstepping» (2) to backstep the stitches.



5.6 Combining stitch patterns

Overview Combi mode

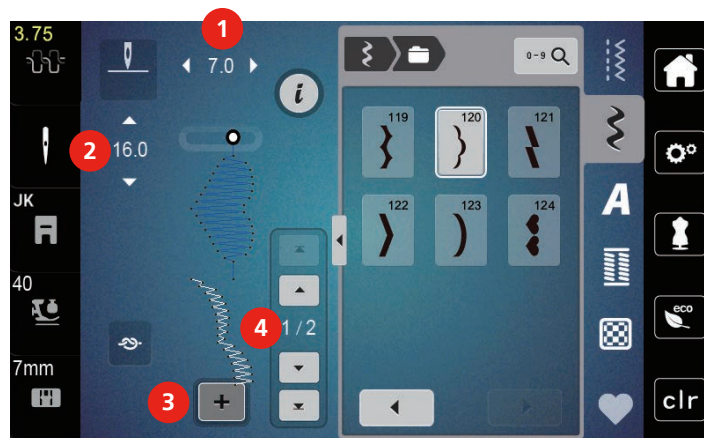

- | | | | |
|---|--|---|--|
| 1 | Stitch width of the active stitch pattern | 3 | Combination mode/single mode |
| 2 | Stitch length of the active stitch pattern | 4 | Individual stitch pattern within the combination |

Creating Stitch pattern combinations

In the Combi mode stitch patterns and alphabets can be combined according to your wish. Each combination can hold up to 20 stitches. Patterns created in the Stitch Designer cannot be integrated in the pattern combinations.



- > Touch the icon «Single/Combi mode» (3).
- > Select the desired stitch patterns.
- > Touch the icon «Single/Combi mode» again to return to the single mode.

Editing a single stitch pattern

- > Create a stitch pattern combination.
- > With the touchscreen pen/finger touch the desired position (1) within the stitch pattern combination to select a single stitch pattern.

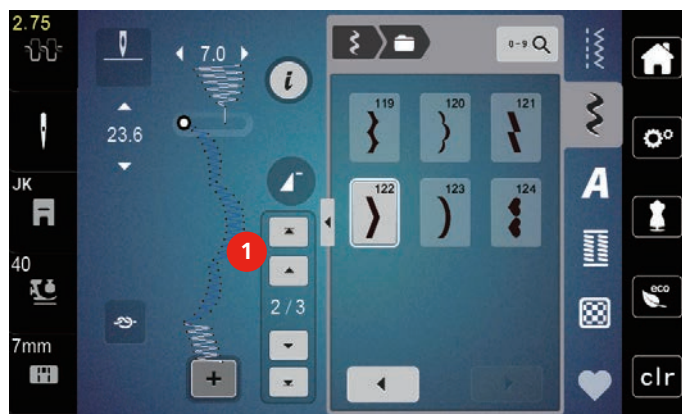

- > Touch the icon «i»-Dialog to edit the single stitch pattern.

Deleting a single stitch pattern

- > Create a stitch pattern combination.
- > With the touchscreen pen/finger touch the desired position (1) within the stitch pattern combination to select a single stitch pattern.



- > Touch the icon «i»-Dialog.



- > Touch the icon «Delete» to delete the individual stitch pattern.

Adding a single stitch pattern

- > In order to add a stitch pattern at the beginning, move to the very front of the stitch pattern group and press the second upper arrow (1).
 - Both upper arrows are inactive.
- > Add a new stitch pattern.

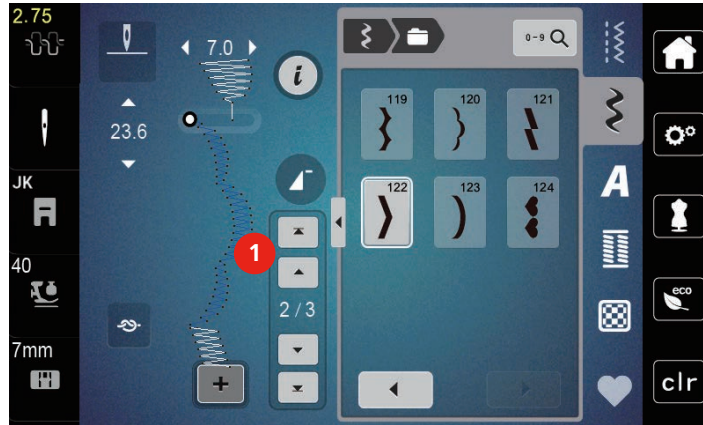

- > Create a stitch pattern combination.
- > Touch the desired position (2) within the stitch pattern combination or touch the scroll arrow (3) to select a single stitch pattern.



Mirroring a stitch pattern combination

- > Create a stitch pattern combination.
- > Touch the icon «i»-Dialog.



- > Touch the icon «Edit the complete combination».

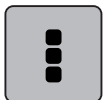

- > Touch the icon «Mirror image left/right» to mirror the whole stitch pattern combination from the left to the right.



- > Touch the icon «Mirror image left/right» again to reset the alterations to default setting.

Programming pattern repeat



- > Create a stitch pattern combination.
- > Touch the icon «i»-Dialog.

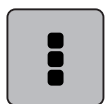

- > Touch the icon «Edit the complete combination».



- > Touch the icon «Pattern repeat» once to repeat the stitch pattern combination.
 - «Securing» at the final end of the combination is activated.
- > Touch the icon «Pattern repeat» again to repeat the stitch pattern combination up to 9 times.
- > Touch the icon «Pattern repeat» and hold until an «X» appears instead of a number.

Securing a stitch pattern combination

Securing stitches at the end of the stitch pattern combination is activated.

- > Touch the icon «Securing at the whole combination end» to deactivate securing at the end of the stitch pattern combination.
- > Create a stitch pattern combination.
- > Touch the icon «i»-Dialog.
- > Touch the icon «Edit the whole combination».



- > Touch the icon «Securing».
 - Every single pattern of the stitch pattern combination can be secured at the start or at the end.

Saving a stitch pattern combination

To be able to use individually created stitch pattern combinations, they can be saved in «Personal Memory».

- > Create a stitch pattern combination.
- > Touch the icon «Personal memory».



- > Touch the icon «Save stitch pattern».



- > Touch the icon «Confirm» or the yellow-framed icon to save the stitch pattern combination.

Loading a stitch pattern combination



- > Touch the icon «Single/Combi mode».



- > Touch the icon «Personal memory».



- > > Touch the icon «Selection of stitch pattern combination».
- > Select a stitch pattern combination.

Overwriting a stitch pattern combination



- > Create a stitch pattern combination.
- > Touch the icon «Personal memory».



- > Touch the icon «Save stitch pattern».
- > Select the stitch pattern combination which is to be overwritten.



- > Touch the icon «Confirm» to overwrite the stitch pattern combination.

Deleting a stitch pattern combination



- > Create a stitch pattern combination.
- > Touch the icon «i»-Dialog.



- > Touch the icon «Edit the complete combination».



- > Touch the icon «Delete».



- > Touch the icon «Confirm».

5.7 Administering stitch patterns

Saving stitch patterns in personal memory

In the filing system «Personal memory» any stitch patterns, also those which have been individually edited, can be saved.

- > Select a stitch pattern, alphabet or buttonhole.
- > Edit the stitch pattern.
- > Touch the icon «Personal memory».



- > Touch the icon «Save stitch pattern».



- > Touch the icon «Confirm».

Overwriting stitch patterns from the personal memory

Prerequisite:

- The stitch pattern is saved in the personal memory.

- > Select a stitch pattern, alphabet or buttonhole.
- > Edit the stitch pattern.



- > Touch the icon «Personal memory».



- > Touch the icon «Save stitch pattern».
- > Select the stitch pattern which should be overwritten.



- > Touch the icon «Confirm».

Loading stitch patterns from the personal memory

Prerequisite:

- The stitch pattern is saved in the personal memory.



- > Touch the icon «Personal memory».



- > Touch the icon «Load stitch pattern».
- > Select a stitch pattern.

Deleting stitch patterns from the personal memory

Prerequisite:

- The stitch pattern is saved in the personal memory.



- > Touch the icon «Personal memory».



- > Touch the icon «Delete».
- > Select a stitch pattern.









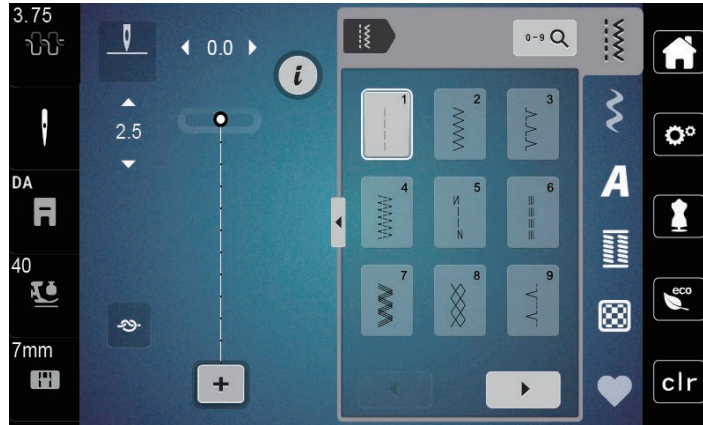

















- > Touch the icon «Confirm».

6 Practical stitches

6.1 Overview Practical stitches



Stitch patterns	Stitch number	Name	Description
	1	Straight stitch	Seams and topstitching.
	2	Zigzag	Reinforcing seams, overcasting edges, sewing elastic seams and attaching lace.
	3	Vari overlock	Sewing and finishing in one step of elastic fabrics.
	4	Running stitch	Darning with running stitch, mending fabrics, reinforcing edges.
	5	Securing Program	Securing starts and ends of seams by straight stitching.
	6	Triple Straight stitch	Reinforced seams in heavy fabrics; visible hems and seams.
	7	Triple Zigzag	Reinforced seams in heavy fabrics; visible hems and seams.
	8	Honeycomb stitch	For stretch fabrics and hems. Is also used with elastic thread in the bobbin.
	9	Blindstitch	Blind hems, shell edging effect on soft jerseys and fine material, decorative seams.
	10	Double overlock	Sewing and finishing in one step of stretch fabrics.
	11	Superstretch stitch	For highly stretch fabrics. For all types of clothing.

Stitch patterns	Stitch number	Name	Description
	12	Gathering stitch	Most types of fabric; gathering with shirring elastic, butted seams = butting two pressed edges and sewing together, decorative stitches.
	13	Stretch overlock	Sewing and finishing in one step of stretch fabrics.
	14	Tricot stitch	Visible hems, visible seams in lingerie, sweaters, mending jersey.
	15	Universal stitch	For firm fabrics such as felt and leather. Flat joining seams, visible seams, attaching elastic, decorative seams.
	16	Sewn-out Zigzag	Edge finishing and reinforcing, attaching elastic, decorative seam.
	17	Lycra stitch	For lycra fabrics; flat joining seams and hems, reinforced seaming on underwear.
	18	Stretch stitch	For highly stretch fabrics; open seam for sportswear.
	19	Reinforced overlock	For medium-weight knitware and toweling. Overlock seams, flat joining seams.
	20	Knit overlock	Sewing and finishing in one step of hand and machine knitted fabrics.
	21	Basting stitch	For seams and hems.
	22	Simple Darning Program	Darning of holes and damaged fabric.
	23	Reinforced Darning Program	Reinforcing darning holes and damaged fabric.
	24	Bartack Program	Reinforcing pocket openings, sewing belt loops.

6.2 Sewing straight stitch



Match the stitch length with the sewing project, which means for denim fabrics long stitches (ca. 3 – 4 mm), for fine fabrics short stitches (ca. 2 – 2.5 mm). Match the stitch length with the thread size, e.g. long stitches when topstitching with Cordonnet (ca. 3 – 5 mm).

Prerequisite:

- The Zigzag foot (DA) is attached.



- > Touch the icon «Practical stitches».
- > Select the Straight stitch No.1.

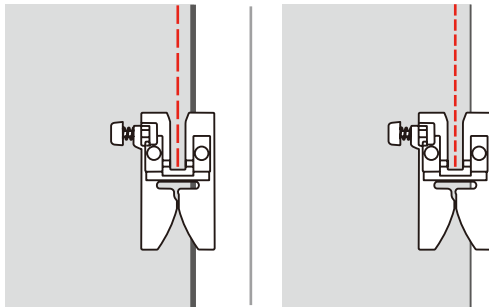

6.3 Securing with the automatic Securing Program

Due to a determined number of 6 stitches sewn forward and 6 stitches sewn backward, the securing is regular.

Prerequisite:

- The Zigzag foot (DA) is attached.



- > Touch the icon «Practical stitches».
- > Select the Securing Program No. 5.
- > Press the foot control.
 - The machine secures automatically.
- > Sew the seam in the desired length.



- > Push the button «Securing».
 - The machine secures automatically and stops at the end of the securing program.

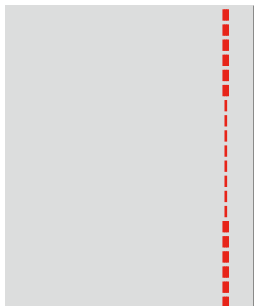

6.4 Sewing in the zipper



As the fabric feed can be difficult when starting to sew, it is recommended to hold the threads firmly or to pull the fabric slightly to the back for a few stitches or to sew 1 – 2 cm reverse first.

- > Attach the Zigzag foot (DA).
- > Touch the icon «Practical stitches».
- > Select the Straight stitch No. 1.
- > Close the zipper length with long stitches.
- > Finish the seam allowances individually.
- > Iron the seam apart.
- > Open the zipper length.
- > Baste the zipper under the fabric so that the fabric folded edges meet over the center of the zipper.

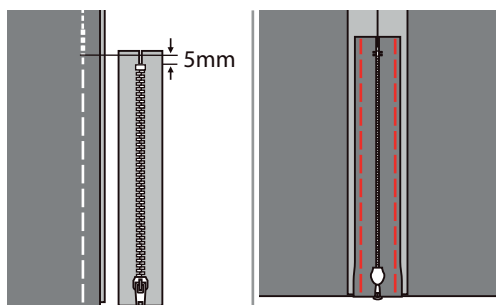

- > Attach the Zipper foot (JB).
- > When sewing the left side of the zipper, attach the right side of the presser foot pin to the holder.

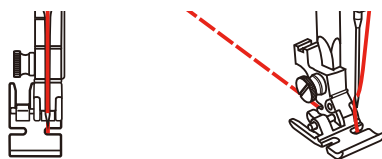

- > When sewing the right side of the zipper, attach the left side of the presser foot pin to the holder.

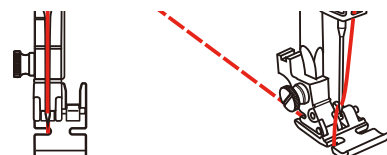

- > Sew the left side of the opened zipper from top to bottom.
- > Close the zipper up to approx. 5 cm from the end.
- > Sew over the lower end and the right side of the zipper.
- > Stop in front of zipper slide with needle position down.
- > Open the zipper.
- > Finish sewing the right side.
- > Remove the basting seam.

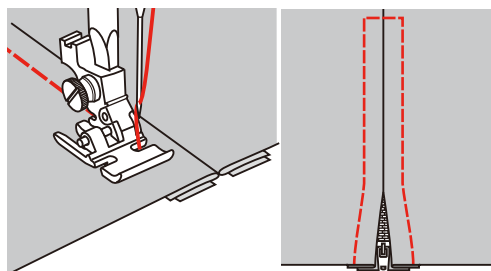

6.5 Sewing Triple straight stitch

The triple straight stitch is especially suitable for durable seams and for firm, densely woven fabrics such as denim and corduroy.

- > Attach the Zigzag foot (DA).
- > Touch the icon «Practical stitches».
- > Select the Triple straight stitch No. 6.

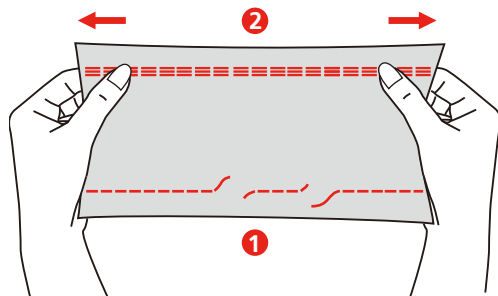

1 Straight stitch

2 Triple Straight stitch

6.6 Sewing Triple zigzag

In firm fabrics, particularly for denim fabrics, deckchair covers, awnings. Hems on items that are frequently washed. Finish the hem edges first.

- > Attach the Zigzag foot (DA).
- > Touch the icon «Practical stitches».
- > Select the Triple zigzag No. 7.

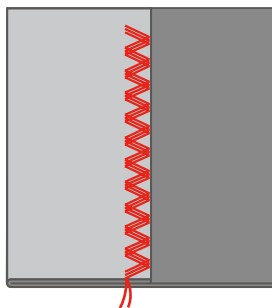

6.7 Manual darning

Used for darning holes or worn areas in all fabric types.

If the thread is lying on top and a poor stitch formation results, slow down the movement of the sewing project. If there are knots on the wrong side of the fabric, move the sewing project faster. When the thread breaks, guide the sewing project more consistently.

- > Remove the presser foot holder and attach the free motion foot (RX) to the presser foot holder bar.
 - The pin (1) should rest on the upper side of the needle clamping screw (2).
- > Press the Free-motion embroidery foot (RX) firmly from below with your index finger and tighten the screw (3).

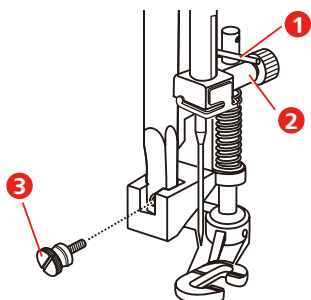

- > Touch the icon «Practical stitches».
- > Select the Straight stitch No. 1.
- > Lower the feed dog.
- > Attach the slide-on table.
- > Hoop the sewing project in the round embroidery hoop (optional accessory).
 - The darning area remains evenly stretched and cannot be deformed.
- > Sew from the left to the right, guide the fabric evenly by hand without using pressure.
- > Move in curves when changing the direction to avoid holes and thread breakage.

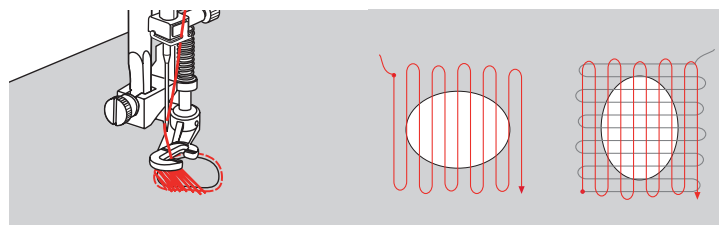

6.8 Automatic darning and Reinforced darning

The simple Darning Program No. 22 is especially suitable for quick darning of worn or damaged areas. It is recommended to use fine material as a backing for the worn and damaged areas or to stick an adhesive interlining. The simple Darning Program No. 22 replaces threads along the lengthwise grain in all materials. If the darning area becomes distorted, correct with the balance.

The reinforced Darning Program No. 23 is especially suitable for quick darning of worn or damaged areas. The reinforced Darning Program No. 23 replaces threads along the lengthwise or transverse grain in all materials.

Prerequisite:

- The underlay material is fixed with basting stitches.
- > Attach the Buttonhole foot with slide (RJ).
- > Touch the icon «Practical stitches».
- > Select the reinforced Darning Program No. 23.



- > Lower the presser foot over the center of the tear.

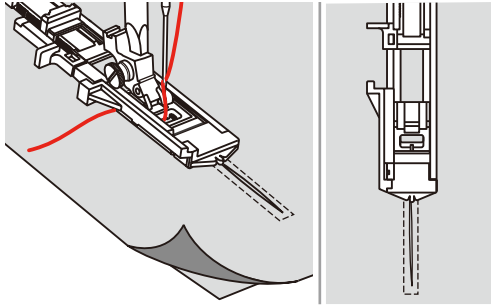

- > Adjust the button holder on the buttonhole foot to the desired length. The size of one darning sequence is variable.
 - The maximum sewing length is 2.6 cm (1 inch) and the maximum sewing width is 7 mm (9/32 inch).

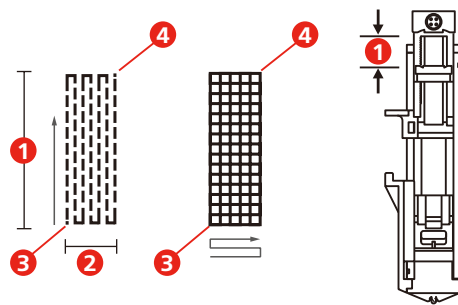
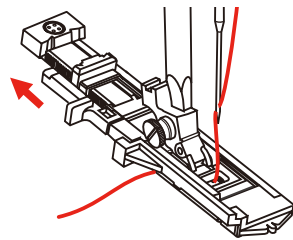

- | | | | |
|---|----------------------|---|-------|
| 1 | The length of sewing | 3 | Start |
| 2 | The width of sewing | 4 | Stop |

- > Position the fabric so that the needle is 2 mm (1/16 inch) in front of the area to be darned.
- > Lower the presser foot.

When lowering the presser foot, do not push the front of the presser foot, otherwise the darning will not be sewn in the correct size.

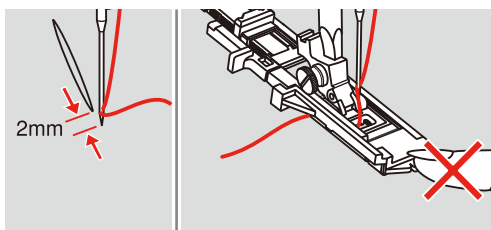

- > Lead the upper thread down through the hole in the presser foot.
- > Pull down the buttonhole lever as far as possible.
 - The buttonhole lever is positioned behind the bracket on the buttonhole foot.

- > Hold the end of the upper thread in your left hand, and then start sewing.

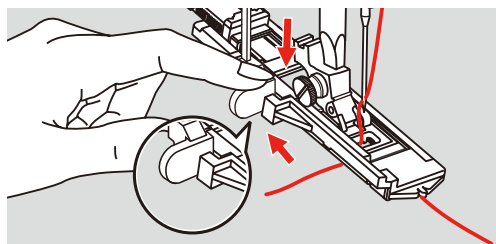

- > If the sewing range is too big to sew, then we recommend to sew the area several times (or cross sew) to get better sewing result.

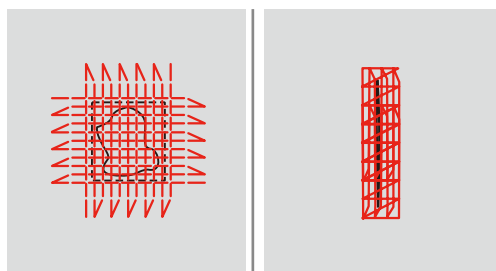

6.9 Finishing edges

The zigzag is suitable for all fabrics. It can also be used for elastic seams and for decorative work. Use darning thread for fine materials. When sewing satin stitch it is recommended to select a dense, short the zigzag with a stitch length of 0.5 – 0.7 mm. The satin stitch can be used for appliqué and for embroidering.

Prerequisite:

- The edge of the fabric should lie flat and not roll.
- > Attach the Zigzag foot (DA).
- > Attach the Zigzag foot (DA).
- > Touch the icon «Practical stitches».
- > Neither select too wide a stitch nor too long a stitch.
- > Guide the edge of the fabric into the center of the presser foot, so that the needle goes into the fabric on one side and over the edge into the air on the other side.

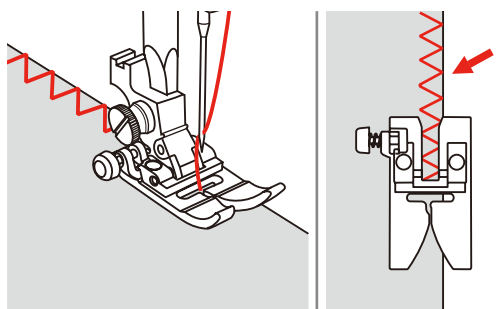

6.10 Sewing Double overlock

A double overlock seam is suitable for loose knits and cross seams in knits. When working with jersey, a jersey needle should be used to prevent damaging the knit fabric. When sewing stretch materials, use a stretch needle.

- > Attach the Zigzag foot (DA).
- > Touch the icon «Practical stitches».
- > Select the Double overlock No. 10.

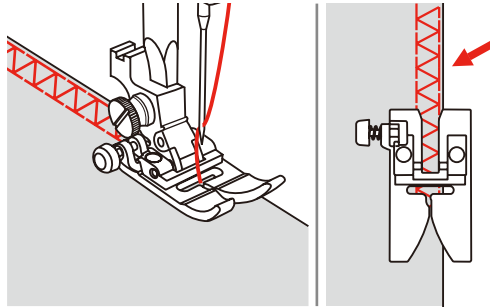

6.11 Sewing Vari overlock

Sewing overcasting stitches along the edges of fabric to prevent them from fraying. When sewing stretch materials, use a stretch needle.

- > Attach the Overlock foot (DI).
- > Touch the icon «Practical stitches».
- > Select the Double overlock No. 3.
- > Sew the fabric with the fabric edge against the guide of the overcasting foot.

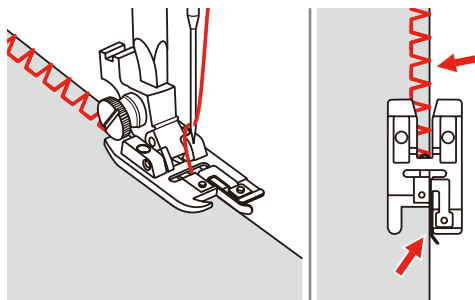

6.12 Edgestitching using the seam guide

When sewing parallel wider lines, it is recommended to guide the seam guide along the sewn of lines.

- > Attach the Zigzag foot (DA).
- > Touch the icon «Practical stitches».
- > Select the Straight stitch No. 1.
- > Insert the seam guide into the hole of the presser foot.
- > Sew the first row and move over the fabric to sew subsequent rows with the guide riding along the previous row of stitching.

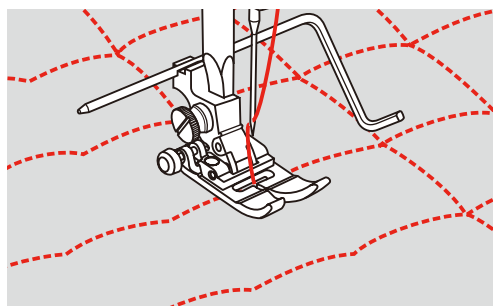

6.13 Sewing a narrow hem



- > Attach the Hemmer foot (DG) Optional accessory.
- > Touch the icon «Practical stitches».
- > Select the Straight stitch No. 1.
- > Fold the edge of the fabric over about 3 mm, then fold it over again 3 mm for about 5 cm along the edge of the fabric.

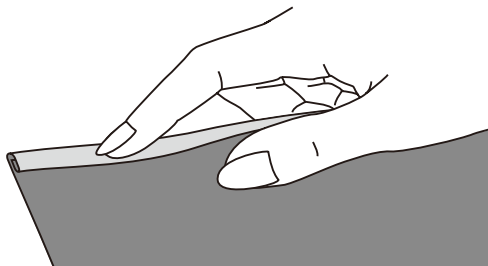

- > Position the needle in the fold by turning the handwheel towards you.
- > Lower the presser foot.
- > Sew several stitches and raise the presser foot.
- > Insert the fabric fold into the spiral opening of the hemmer foot.
- > Move the fabric back and forth until the fold forms a scroll shape.

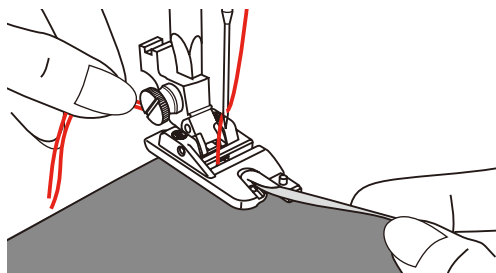

- > Lower the presser foot.
- > Lower the presser foot and start sewing slowly guiding the raw edge of the fabric in front of the hemmer foot evenly into the opening of the foot.

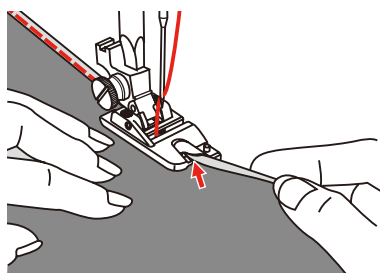

6.14 Sewing blind hems

For invisible hems in medium to heavy weight cotton, wool and blended materials.

Prerequisite:

- The fabric edges are finished.
- > Attach the Blindstitch foot (DM).
- > Touch the icon «Practical stitches».
- > Select the Blindstitch No. 9.

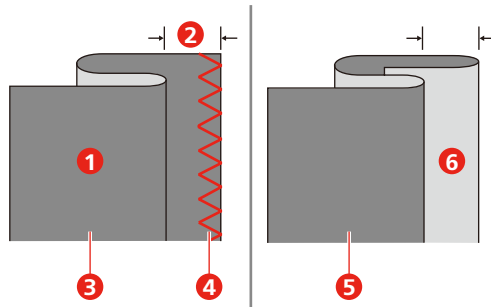

- > Turn the handwheel forwards by hand until the needle swings fully to the left.
- > It should just pierce the fold of the fabric. If it does not, adjust the stitch width accordingly.
- > Adjust the guide (2) by turning the knob (1) so that the guide just rests against the fold.

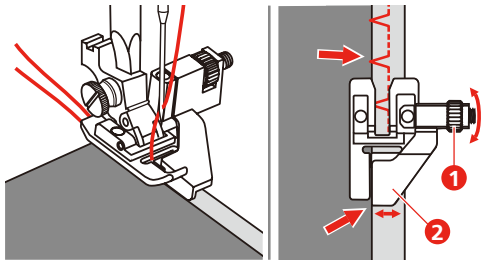

- > Sew slowly, guiding the fabric carefully along the edge of the guide.

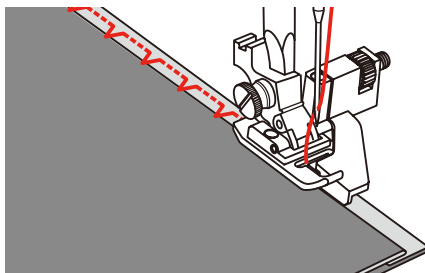

– Turn over the fabric

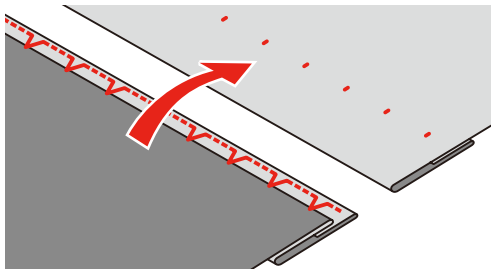

6.15 Sewing visible hems

The visible hem is particularly suitable for elastic seams in tricot made of cotton, wool, synthetic and mixed fibers.



- > Attach the Embroidery foot (JK).
- > Touch the icon «Practical stitches».
- > Select the Tricot stitch No. 14.
- > Iron the hem and baste if necessary.
- > Reduce the presser foot pressure if necessary.
- > Sew the hem in the desired depth on the right side.
- > Trim off the remaining fabric on the reverse side.

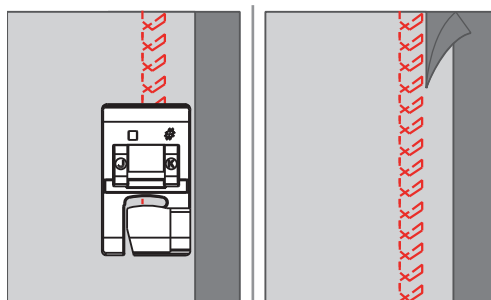

6.16 Sewing basting stitches

When sewing basting stitches, it is recommended to use a fine darning thread. This is easier to remove. The longest stitch possible is 5 mm. The recommended stitch length is 3.5 – 5 mm. The basting stitch is suitable or sewing projects where a very long stitch length is required.



- > Attach the Zigzag foot (DA).
- > Touch the icon «Practical stitches».
- > Select the Basting stitch No. 21.
- > Select the stitch length.
- > Pin the fabric layers at a right angle to basting direction to prevent the layers from slipping.
- > Sew 3 – 4 securing stitches at the beginning and at the end.

6.17 Sew thick areas

- > Attach the Zigzag foot (DA).
 - The black button on the left side of the presser foot will lock the presser foot in a horizontal position if you push it in before lowering the presser foot (1). This ensures even feeding at the beginning of a seam and helps when sewing multiple layers of fabric such as sewing over seams when hemming jeans.
- > When you reach the point of an increased thickness, lower the needle and raise the presser foot.
- > Press the toe of the foot and push in the black button, then lower the foot and continue sewing.
 - The black button releases automatically after sewing few stitches.

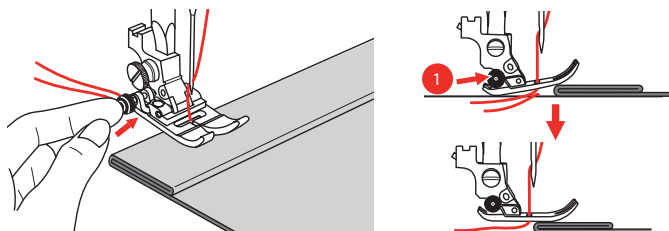

To support the presser foot while manually supplying and sewing towards the folded edge, place another piece of fabric with the same thickness on the backside of the seam.

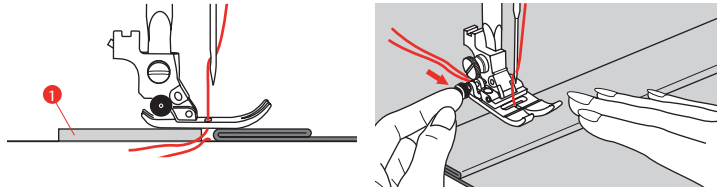

1 Cardboard or thick fabric

6.18 Sewing Corners



- > Stop the sewing machine when you reach a corner.
- > Pierce the needle into the fabric.



- > Raise the presser foot.
- > Use the needle as a pivot and turn the fabric.
- > Lower the presser foot and continue sewing.

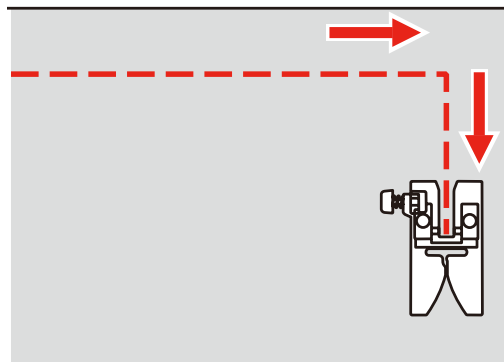

7 Decorative stitches

7.1 Overview Decorative Stitches

Depending on the type of material, simple or more complex decorative stitches should be selected to best suit the material.

- Decorative stitches which are programmed with simple straight stitches are particularly appropriate for light-weight materials, e.g. the Decorative stitch No. 142.
- Decorative stitches which are programmed with triple straight stitches or with a few satin stitches are particularly appropriate for medium-weight materials, e.g. Decorative stitch No. 152.
- Decorative stitches which are programmed with satin stitches are particularly appropriate for medium-weight materials, e.g. Decorative stitch No. 142.

For a perfect stitch formation it is of advantage to use the same thread color for upper and bobbin thread and a stabilizer. With pile or longfiber materials it is recommended to use an additional, water-soluble stabilizer on the right side which can be easily removed after sewing.

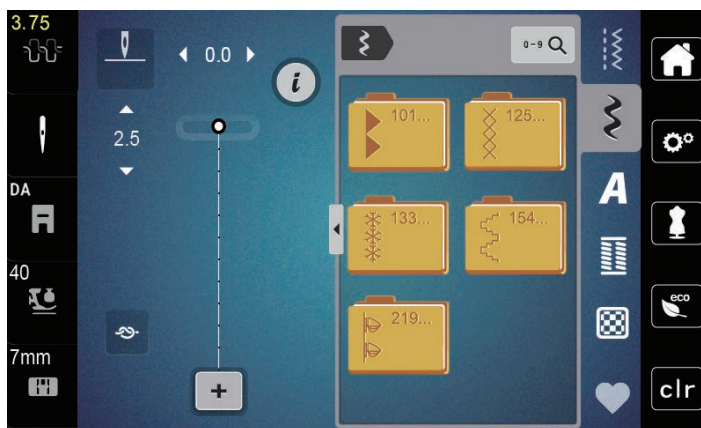

Decorative stitch	Stitch number	Name
	101-124	Satin stitches
	125-132	Cross stitches
	133-153	Floral stitches
	154-218	Ornamental stitches
	219-233	Novelty

7.2 Altering the stitch density

With satin stitches (e. g. No. 101) the stitch density can be altered. If the stitch density is increased, the stitch distance is enlarged. If the stitch density is decreased, the stitch distance is shortened. The programmed length of the stitch pattern is not affected.

- > Select the satin stitch.
- > Touch the icon «i»-Dialog.



- > Touch the icon «Edit pattern length/stitch density».
- > Adjust the stitch density via the icons (1) «-» or «+».



7.3 Sewing cross stitches

Cross stitching is a traditional technique, and extends the range of decorative stitches. If the cross stitches are sewn on fabric with a linen texture, they look like hand-stitched cross stitching. When cross stitches are sewn with cotton embroidery thread, the stitch pattern appears fuller. Cross stitches are particularly used for home furnishing, trimmings on garments and embellishing in general. As every following line refers to the first row, it is important to stitch the first row in a straight line.

- > Attach the Zigzag foot (DA) or the Embroidery foot (JK) or the Open embroidery foot (DN) (optional accessory).
- > Select a cross stitch of the Decorative stitch No.125-132 and combine it as desired.
- > Stitch the first row using the seam guide to sew a straight line.
- > Stitch the second row next to the first at a distance of one presser foot's width or using the seam guide.

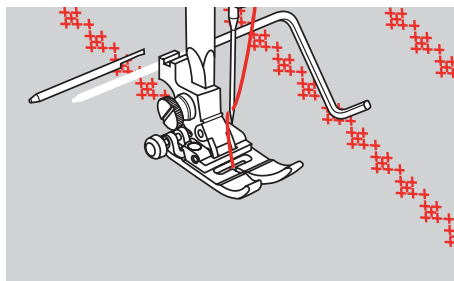
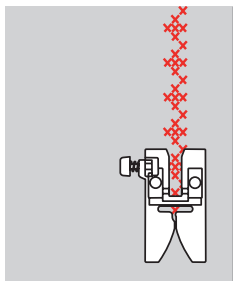

8 Alphabets

8.1 Overview Alphabet

Block, Double block and Script alphabets can be sewn in two different sizes, in upper and lower case letters. For a perfect stitch formation it is recommended to use the same thread color for upper and bobbin threads. The fabric can be reinforced with embroidery stabilizer on the wrong side. When working with pile or napped fabrics, e.g. toweling, use an additional, water-soluble stabilizer on the right side of the fabric.

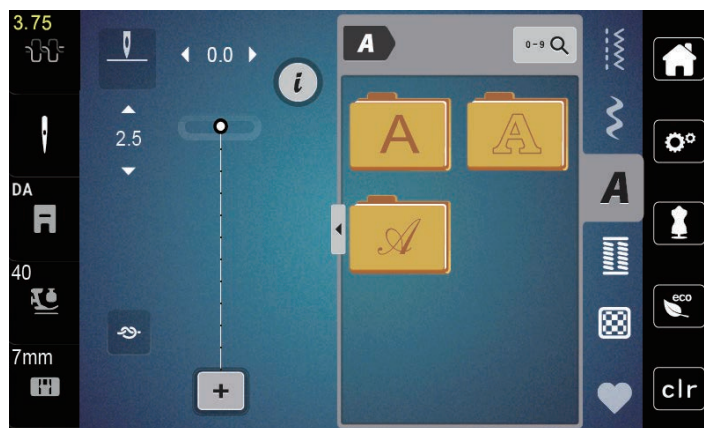

Stitch patterns	Name
ABCabc	Block alphabet
ABCabc	Double-Block
ABCabc	Script (Italics)

8.2 Creating lettering



It is recommend to sew a test sample using the desired thread, the original fabric and the original stabilizer. Please make sure that the fabric is fed evenly and lightly without colloding and being caught. Do not pull, push or hold the fabric while sewing.



- > Touch the icon «Alphabets».
- > Select the font.



- > To create a combination, touch the icon «Single mode/Combi mode» (1).

- > To open the extended entry mode, touch the icon «Display alphabets» (2).

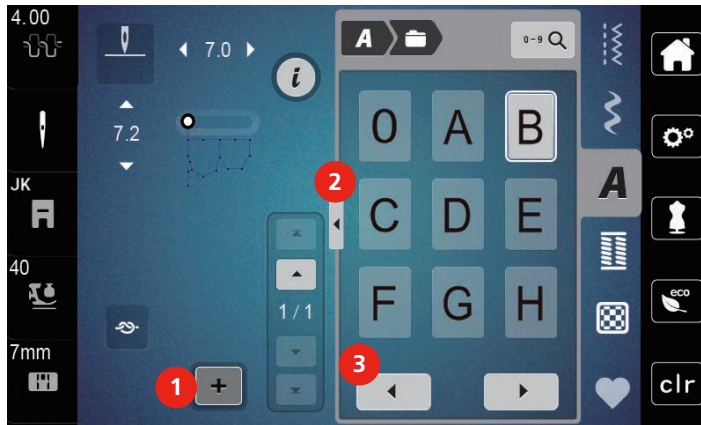

- > Select the letter.



- > To have more letters displayed, touch the icon «Scroll left» (3).



- > To delete individual letters of the entered text, touch the icon «DEL».

- > To close the extended entry mode, touch the icon «Display alphabets» (1) again.





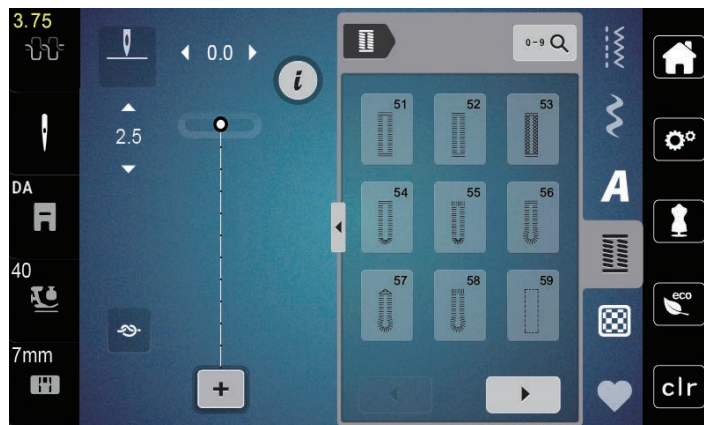

9 Buttonholes

9.1 Overview Buttonholes

To create the correct buttonhole for every button, every purpose and for every garment, the bernette b77 is equipped with a considerable collection of buttonholes. The corresponding button can be sewn on automatically. Eyelets can also be sewn.



Buttonhole	Buttonhole number	Name	Description
	51	Standard buttonhole	For light to medium-weight fabrics blouses, dresses, bedlinen.
	52	Standard buttonhole narrow	For light to medium-weight fabrics blouses, dresses, children's and baby clothes, crafts.
	53	Stretch buttonhole	For any highly elastic jersey made from cotton, wool, silk and synthetic fibers.
	54	Round buttonhole with normal bartack	For medium to heavy-weight fabrics dresses, jackets, coats, rain wear.
	55	Round buttonhole with horizontal bartack	For medium to heavy-weight fabrics in all kinds of different materials; dresses, jackets, coats, rain wear
	56	Keyhole buttonhole	For firmer, non-stretch fabrics jackets, coats, leisure wear.
	57	Keyhole buttonhole with pointed bartack	For firm, non-stretch fabrics; jackets, coats, leisure wear.
	58	Keyhole buttonhole with horizontal bartack	For firm, non-stretch fabrics; jackets, coats, leisure wear.

Buttonhole	Buttonhole number	Name	Description
	59	Straight stitch buttonhole	Program for staystitching buttonholes, for pocket openings, reinforcing buttonholes, especially for buttonholes in leather and imitation leather.
	63	Heirloom	For light to medium-weight woven fabrics blouses, dresses, leisure wear, bedlinen.
	64	Double-rounded buttonhole	For medium to heavy-weight fabrics in all kinds of different materials.
	66	Buttonhole with double pointed bartack, narrow	Decorative buttonhole for medium weight fabrics blouses, dresses, jackets.
	69	Decorative buttonhole with double pointed bartack	For decorative buttonholes in firmer, non-elastic fabrics.
	71	Stretch buttonhole	For jeans or stretch fabric with a coarse weave.
	60	Button sew-on program	For buttons with 2 and 4 holes.
	61	Eyelets with small zigzag	Openings for cords and narrow ribbons, for decorative work.
	62	Straight-stitch eyelet	Openings for cords and narrow ribbons, for decorative work.

9.2 Marking buttonholes

- > Mark the positions of the buttonhole on the fabric.
 - The maximum buttonhole length is 3 cm (1 3/16 inch). (Total of diameter + thickness of button.)
- > The size of the buttonhole is determined by the button inserted in the buttonholder plate.

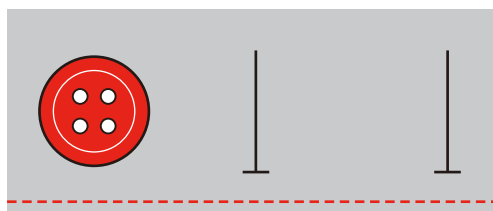

9.3 Sewing a buttonhole automatically

- > Attach the Buttonhole foot with slide (RJ).
- > Pull out the button holder plate and insert the button.
- > Guide the thread through the hole in the presser foot and then place it under the foot.
- > Touch the icon «Buttonholes».
- > Select the buttonhole stitch.

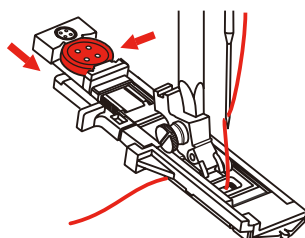

- > Adjust the stitch width and stitch length to the desired width and density.
- > Position the fabric under the presser foot so that the marking of the centerline is aligned with the starting point (1).

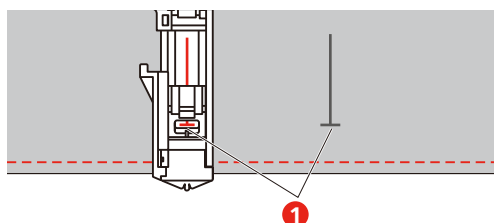

- > Press the button «Start/Stop».
 - While the buttonhole lever is raised, the display shows an error message to lower the buttonhole lever.
- > Pull the buttonhole lever down as far as possible until it clicks into place.

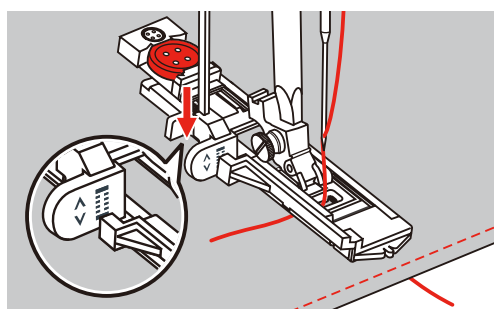

- > Hold the upper thread vertically to the Buttonhole foot with slide and start sewing.
 - After the buttonhole has been sewn, the machine automatically sews a securing stitch before stopping.

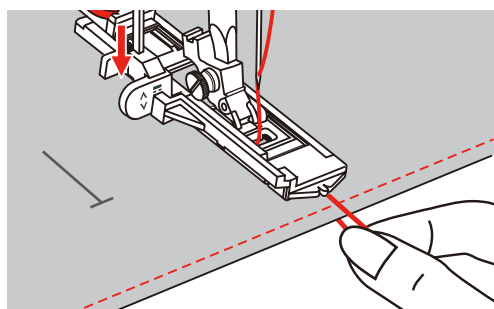

- The buttonholes are sewn backwards from the front of the presser foot as illustrated.

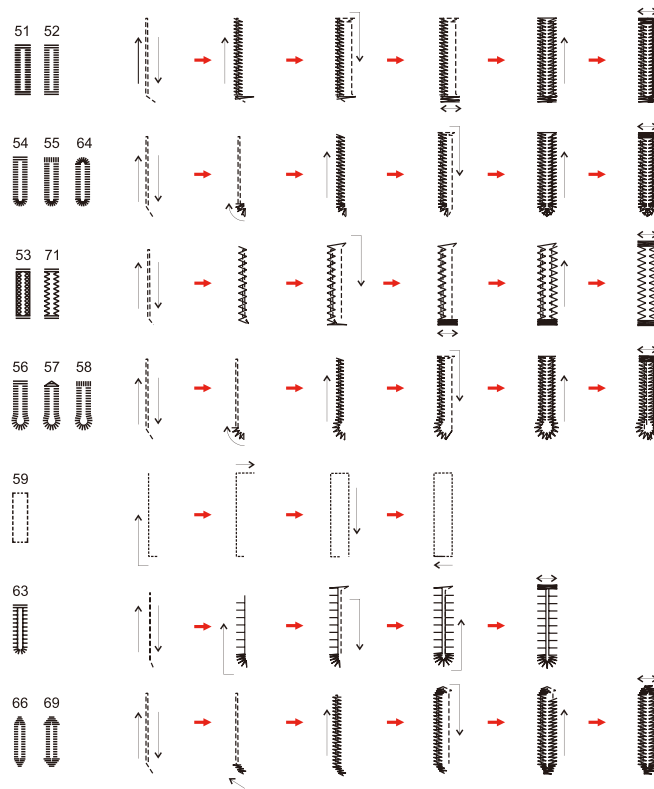

- > Raise the sewing foot and cut the thread.
- > After sewing the buttonhole, raise the buttonhole lever to the stop.

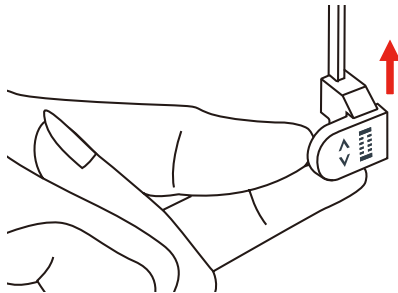

- > Cut the buttonhole open and make sure that the beads are not cut on either side. Use a pin as a stop at the bartack to avoid cutting too far.

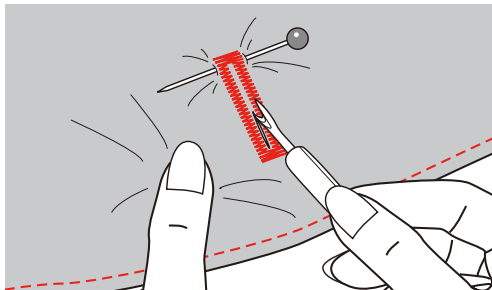

9.4 Reinforce buttonhole

When sewing buttonholes on stretch fabric, hook a heavy thread or a cord under the buttonhole foot.

- > Attach the Buttonhole foot with slide (RJ).
- > Pull out the button holder plate and insert the button.
- > Pass the thread through the hole in the presser foot and then place it under the foot.

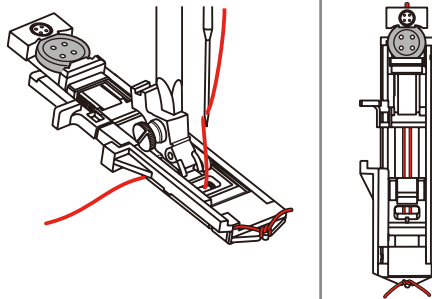

- > Bring the two cord ends to the front of the foot and insert them in the grooves, then temporarily tie them there.
- > The stitch width and stitch length has to be adjusted before the sewing starts.

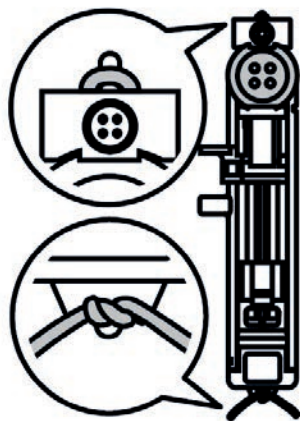

- > Lower the presser foot and sew the buttonhole.
 - The buttonhole will sew over the cord, covering it.
- > Pull the cord loop until the loop disappears in the bartack.
- > Pull the cord ends with the hand sewing needle to the back and knot or secure them.

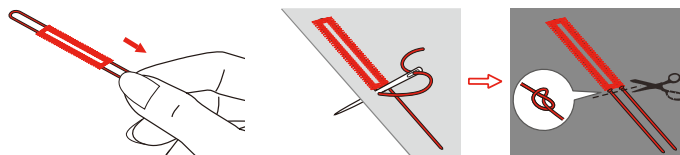

9.5 Sewing on buttons

With the button sew-on program, buttons with 2 or 4 holes, push buttons or latches can be sewn on. For a increased stability the button sew-on program can be sewn twice. When sewing on a button with 4 holes, the front holes should be sewn first.

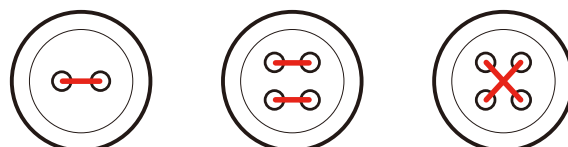

With the Button sew-on Program the first securing stitch is always stitched into the left hole of the button.



- > Attach the Button-sew-on foot (RC).
- > Touch the icon «Buttonholes».
- > Lower the feed dog.
- > Select the Button sew-on Program No. 60.
- > Place the button on the sewing project.
- > Check distances between holes with the handwheel. If necessary, alter the stitch width.

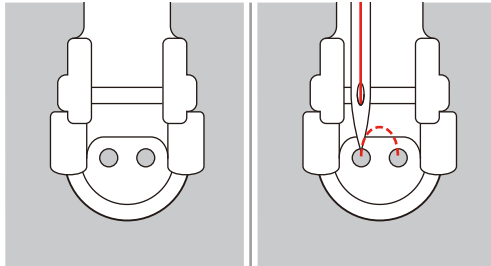

- > Hold the threads when starting to sew.
 - The machine sews the Button sew-on Program and stops automatically.
 - If a shank is required, place a darning needle on top of the button and sew.
- > Pull on both bobbin threads until the ends of the upper threads are visible on the wrong side.
- > Knot the ends manually.

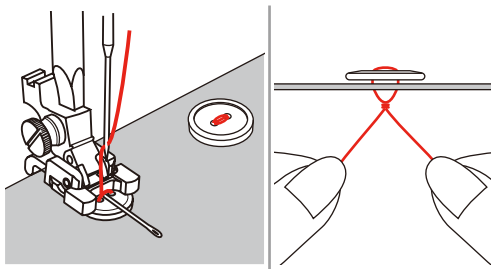

9.6 Sewing eyelets



For increased stability sew the eyelet twice.



- > Attach the Zigzag foot (DA) or the Embroidery foot (JK) or the Open embroidery foot (DN) (optional accessory).
- > Touch the icon «Buttonholes».
- > Select the Eyelet Program No. 61 or No. 62.
- > Turn the «Upper Multifunction knob» or the «Lower Multifunction knob» to alter the size of the eyelet.
- > Sew the Eyelet Program.
 - The machine stops automatically at the end of the Eyelet Program.
- > Use an awl, punch pliers or a hole punch to open the eyelet.

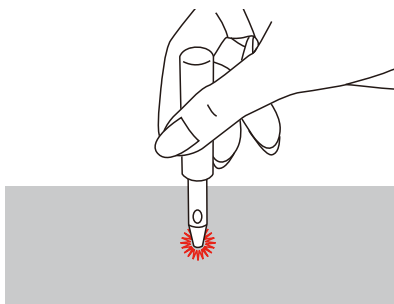

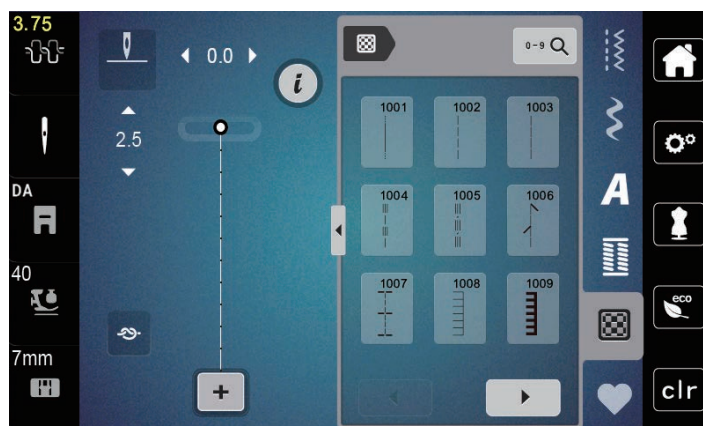

10 Quilting

10.1 Overview Quilt Stitches



Stitch patterns	Stitch number	Name	Description
	1001	Quilting, Securing Program	To secure at the sewing start and sewing end with short stitches forward.
	1002	Quilting straight stitch	Straight stitch 2 mm stitch length, to join patchwork parts.
	1003	Piecing stitch/Straight stitch	Straight stitch at 3 mm stitch length.
	1004	Handlook quilt stitch 1005, 1030, 1034, 1035	Imitation of handlook quilt stitch with monofilament.
	1006	Decorative Quilt stitch variations 1007, 1010-1012, 1015-1019, 1025-1027, 1031-1032	For "Crazy Patchwork" and embellishing.
	1008	Blanket stitch	For appliqué and sewing on ribbons.
	1009	Double blanket stitch	For appliqué and sewing on ribbons.
	1013	Blanket stitch dual	To edgestitch between two appliqués, "Crazy Patchwork".
	1014	Double blanket stitch dual	To edgestitch between two appliqués, "Crazy Patchwork".

Stitch patterns	Stitch number	Name	Description
	1020	Feather stitch variations 1021-1023	For "Crazy Patchwork" and embellishing.
	1024	Stippling stitch	Imitation of stipple quilting.
	1029	Feather stitch 1028, 1033	For "Crazy Patchwork" and embellishing.

10.2 Quilting, Securing Program



- > Attach the Zigzag foot (DA).
- > Touch the icon «Quilt stitches».
- > Select Quilt stitch pattern No. 1001.
- > Press the foot control.
 - The machine sews 5 stitches forward automatically when sewing is started.
- > Sew the seam in the desired length.



- > Push the button «Securing».
 - The machine sews 5 stitches forward automatically and stops automatically at the end of the Securing Program.

10.3 Sewing handlook quilt stitches

Hand quilt stitches are suitable for all fabrics and sewing projects that should look like hand-sewn. It is recommended to use a monofilament thread as upper thread and an embroidery thread as bobbin thread. The sewing speed should be moderate to prevent the monofilament from breaking. If required, the upper thread tension and the balance can be adjusted to the sewing project and the desired quilt stitch.

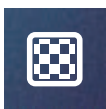

- > Attach the embroidery foot (JK) / Zigzag foot (DA).
- > Touch the icon «Quilt stitches».
- > Select the Hand quilt stitch No. 1004 or 1005.
- > If necessary, adjust the upper thread tension and the balance to suit the sewing project and the desired quilt stitch.
- > Press the foot control or the button «Start/Stop» to start the machine.

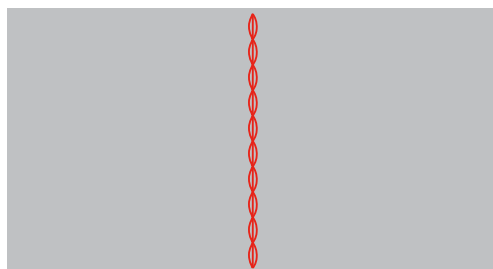

10.4 Guiding the quilt work freely



Quilt gloves with rubber fingertips (optional accessory) will help when guiding the fabric.

It is recommended to use the extension table (optional accessory) and the Free Hand System. With free-motion quilting, it is of advantage to quilt from the center outwards and to guide the fabric using smooth, round movements to form the design of your choice. Free-motion quilting and darning are based on the same free-motion principles.

With stipple quilting, entire surfaces of the fabric are filled with quilt stitches. The single lines of stitching are rounded and never cross one another.

Prerequisite:

- The top layer, the batting and the backing are pinned together or basted.
- > Lower the feed dog.
- > Attach the free-motion embroidery foot (RX) to the presser foot holder bar.
 - The pin (1) of the Darning-/Embroidery foot should lay on the top of the needle clamp screw (2).
- > Press the free-motion foot on firmly from below with your index finger and tighten the screw (3).

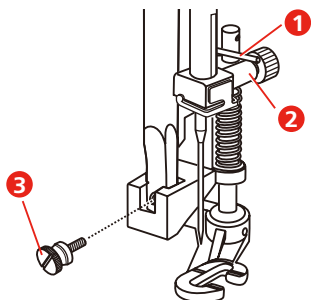

- > Touch the icon «Practical stitches».
- > Select the Straight stitch No. 1.
- > If necessary adjust the upper thread tension according to the sewing project.
- > Press the foot control or the button «Start/Stop» to start the machine.
- > Hold both hands close to the presser foot like an embroidery hoop to guide the fabric.
- > If the thread is lying on top of the fabric, slow down the movement.
- > If there are knots on the wrong side of the fabric, move the fabric more quickly.

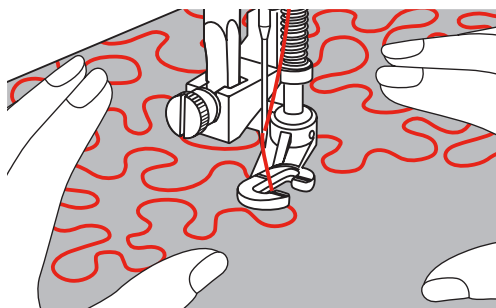

11 Appendix

11.1 Maintenance and cleaning

Cleaning and maintenance intervals

To ensure the functionality and sewing quality of the machine, the machine must be cleaned and maintained regularly. The intervals for cleaning and maintenance of the machine depend on various factors, such as the fabrics and threads used.

As an advice to clean the machine, a message appears after 500,000 stitches.

As an advice to have the machine maintained, a message appears when 4,000,000 stitches have been sewn after a service.

Cleaning the display

- > Clean the display in the switched off status with a soft slightly damp microfiber cloth.

Cleaning the feed dog

Remove the thread remnants under the stitch plate regularly.



Electronically driven components

Risk of injury near the needle and the hook.

- > Raise the presser foot.
- > Switch the machine off and disconnect it from the power supply system.

- > Remove the presser foot and the needle.
- > Lower feed dog.

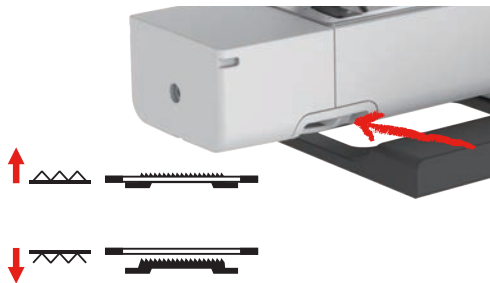

- > Remove the stitch plate.
- > Clean the feed dog with the brush.

Cleaning the hook



Electronically driven components

Risk of injury near the needle and the hook.

- > Raise the presser foot.
- > Switch the machine off and disconnect it from the power supply system.

- > Remove the needle and the presser foot.
- > Remove the stitch plate.
- > Clean the bobbin case with a brush.

Please note: The markings of the bobbin case and the stitch plate must be aligned identically.

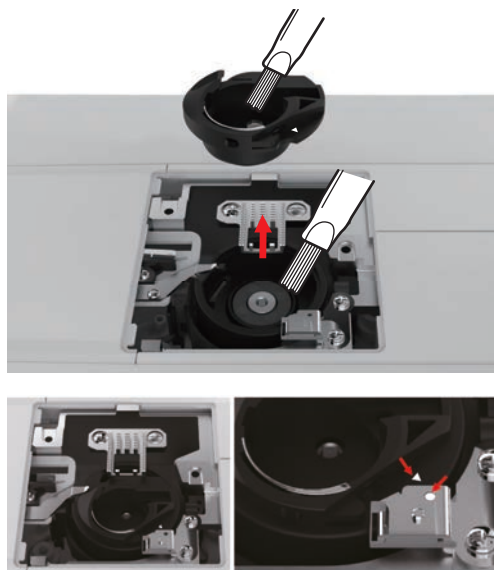

Oiling the needle bar

The needle bar may not move smoothly without lubrication. If the machine is used frequently, the needle bar should be oiled every 6 months to prevent blocking.



Electronically driven components

Risk of injury near the needle bar.

> Switch off the machine and disconnect it from the power supply.

> Remove the protective cap (1) and the screw (2).

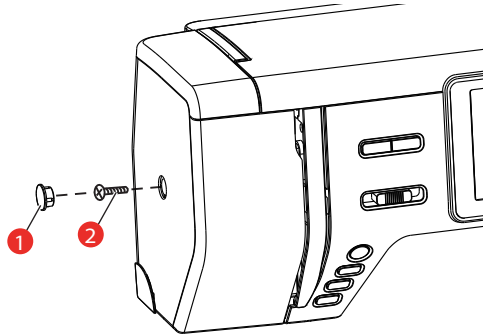

> Remove headframe cover (3).

– After removing the headframe cover, pay attention to the moving parts.

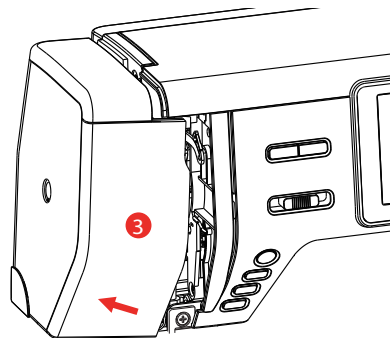

> Apply a drop of oil to the movement mechanism of the needle bar, including the connecting rod/needle bar, needle bar holder and needle bar holder (apply oil to the points marked with an arrow).

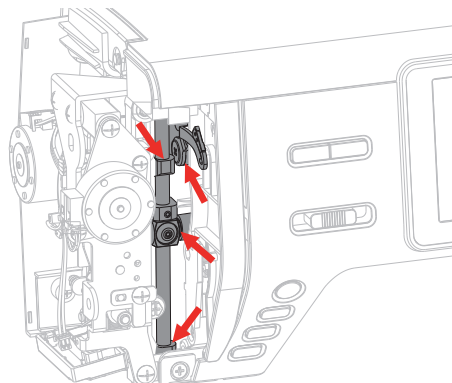

> Remove the presser foot.

> Turn the handwheel a few times and remove excess oil with a cloth.

> Attach the headframe cover again.







11.2 Troubleshooting



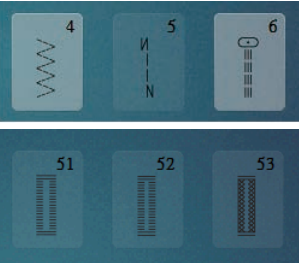

Fault	Cause	Repair
Uneven stitch formation	Upper thread too tight or too loose.	> Adjust the upper thread tension.
	Needle blunt or bent.	> Replace the needle, make sure that a new BERNINA quality needle is used.
	Poor quality needle.	> Use a new BERNINA quality needle.
	Poor quality thread.	> Use quality thread.
	Incorrect needle/thread combination.	> Match the needle with the thread size.
	Incorrectly threaded.	> Rethread.
	The fabric has been pulled.	> Feed the fabric evenly.
	Dust or thread remnants under the tension spring of the bobbin case.	> Clean the hook.
Skipped stitches	Incorrect needle.	> Use the needle system 130/705H.
	Needle blunt or bent.	> Replace the needle.
	Poor quality needle.	> Use a new BERNINA quality needle.
	The needle is incorrectly inserted.	> Insert the needle with the flat side to the back as far up as it will go into the needle holder and tighten the screw.
	Incorrect needle point.	> Match the needle point to the texture of the material.
Faulty stitching	Thread remnants between the thread tension discs.	> Fold a piece of thin material and slide the folded edge (not the raw edges) between the thread tension discs.
	Incorrectly threaded.	> Rethread.
	Thread is caught in the hook.	> Remove the upper thread and the bobbin case, turn the handwheel backwards and forwards by hand and remove the thread remnants.
	Incorrect needle/thread combination.	> Check the needle/thread combination.

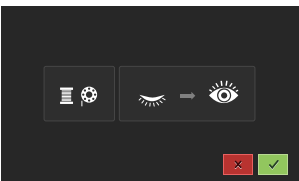
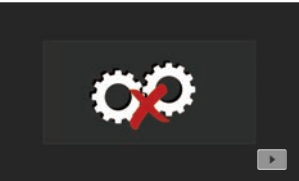

Fault	Cause	Repair
Upper thread breaks	Incorrect needle/thread combination.	> Match the needle with the thread size.
	Upper thread is too tight.	> Reduce the upper thread tension.
	Incorrectly threaded.	> Rethread.
	Poor quality thread.	> Use quality thread.
	The stitch plate or the hook tip is damaged.	> Contact a specialized bernette dealer to have the damages repaired. > Replace the stitch plate.
Lower thread breaks	The bobbin is not inserted correctly.	> Remove and reinsert the bobbin and pull on the thread. – The thread should run easily.
	Bobbin is wound incorrectly.	> Check bobbin and thread correctly.
	The stitch hole in the stitch plate damaged.	> Contact a specialized bernette dealer to have the damages repaired. > Replace the stitch plate.
	Needle blunt or bent.	> Replace the needle.
Needle breaks	The needle is incorrectly inserted.	> Insert the needle with the flat side to the back as far up as it will go into the needle holder and tighten the screw.
	The fabric has been pulled.	> Feed the fabric evenly.
	Thick fabric has been pushed.	> Use the appropriate presser foot, e.g. Jeans foot No. 8 for thick material. > Use the height compensating tool when sewing over a thick seam.
	Knotted thread.	> Use quality thread.
Display is inactive	Incorrect calibrating data.	> Switch the machine off. > Switch the machine on and simultaneously press and hold down the buttons «Needle left/right». > Recalibrate the display.
	eco mode activated.	> Touch the icon «eco».
Stitch width not adjustable	The selected needle and stitch plate cannot be used in combination.	> Replace the needle. > Replace the stitch plate.

Fault	Cause	Repair
Speed too low	Unfavorable room temperature.	> Place the machine in a warm room one hour before use.
	Settings in the Setup Program.	> Adjust the sewing speed in the Setup Program. > Adjust the slide.
The machine doesn't start	Unfavorable room temperature.	> Place the machine in a warm room one hour before use. > Connect the machine and switch it on.
	The machine is damaged.	> Contact a specialized bernette dealer.
The light of the button «Start-/Stop» doesn't light up	Light is defect.	> Contact a specialized bernette dealer.
Neither the sewing light nor the light on the free arm lights up	Settings in the Setup Program.	> Activate it in the Setup Program.
	The sewing light is defect.	> Contact a specialized bernette dealer.
Upper thread indicator doesn't react	Settings in the Setup Program.	> Activate it in the Setup Program.
	The upper thread indicator is defect.	> Contact a specialized bernette dealer.
Bobbin thread indicator doesn't react	Settings in the Setup Program.	> Activate it in the Setup Program.
	The bobbin thread indicator is defect.	> Contact a specialized bernette dealer.

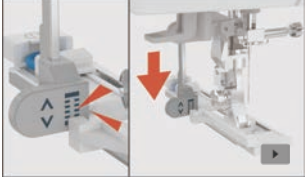
11.3 Error messages

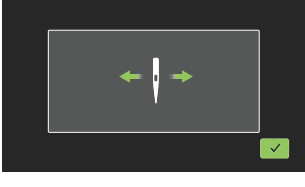
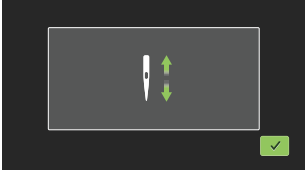
Message on the display	Cause	Repair
	This stitch number does not exist.	> Check the entry and enter the new number.
	Stitch pattern selection not possible in combi mode.	> Check the entry and enter the new number.
	The stitch number cannot be selected in combi mode.	> Select other stitches.
	The selected needle and stitch plate cannot be used in combination.	<ul style="list-style-type: none"> > Check whether the correct needle and stitch plate are attached. > Exchange the needle and select it in the user interface. > Exchange the stitch plate and select it in the user interface.
	The winding unit is activated.	> Deactivate the winding unit.
	The thread indicator is deactivated.	<ul style="list-style-type: none"> > To activate both thread indicators, touch the icon «Confirm». > To keep the thread indicators deactivated, touch the icon «Cancel».
 	The main motor isn't running.	<ul style="list-style-type: none"> > Turn the handwheel clockwise until the needle is at its top position. > Remove the stitch plate. > Remove the thread remnants. > Clean the hook. > Remove the hook and make sure that no broken needle tips stick to the magnetic back of the hook.

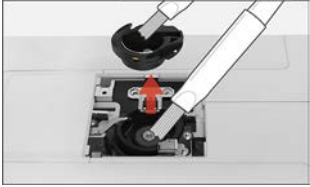
Message on the display	Cause	Repair
	The upper thread is used up.	<ul style="list-style-type: none"> > Insert a new thread spool. > Rethread.
	The upper thread has broken.	<ul style="list-style-type: none"> > Rethread.
	The bobbin thread is used up.	<ul style="list-style-type: none"> > Remove the empty bobbin, wind it again and reinsert it.
	The threader lever is not raised.	<ul style="list-style-type: none"> > Raise the threader lever.
	The buttonhole lever does not touch the buttonhole foot with slide (RJ).	<ul style="list-style-type: none"> > Pull the buttonhole lever down as far as possible until it engages behind the bracket.
	<p>The buttonhole lever is not pulled down.</p> <p>The feed dog is lowered.</p>	<ul style="list-style-type: none"> > Pull the buttonhole lever down as far as possible until it engages behind the bracket. > Lift the feed dog.
	The needle moves sideways.	When the stitch plate is exchanged, this illustration appears because the needle is likely to move.
	The needle moves upwards.	<ul style="list-style-type: none"> > Check whether there are any external objects near the stitch plate. > To raise the needle, touch the icon «Confirm».

Message on the display	Cause	Repair
	500,000 stitches have been sewn with the machine since the last cleaning advice.	<ul style="list-style-type: none"> > Clean the machine. > To be reminded of the cleaning after switching on the machine, touch the icon «Cancel».
	The machine has reached a stitch count of 4,000,000 since the last maintenance by a bernette dealer.	<ul style="list-style-type: none"> > Contact your specialized bernette dealer to have the machine maintained. > To be reminded of the maintenance after switching on the machine, touch the icon «Cancel».











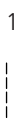
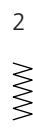

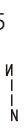









11.4 Technical data

Name	Value	Unit
Sewing light (LED)	300, 2	mA, Watt
Maximum speed	Sewing mode: 1000	Stitches per minute
Measurements (w x d x h)	509 x 199.8 x 314.3	mm
Weight	10	kg
Energy consumption	100	W
Input voltage	100 – 240	V
Protection class (Electrical Engineering)	Protection class II	

















12 Overview stitch patterns

12.1 Overview Stitch patterns

Practical stitches

























1 	2 	3 	4 	5 	6 	7 	8 	9 	10 	11 
12 	13 	14 	15 	16 	17 	18 	19 	20 	21 	22 
23 	24 									

Buttonholes









51 	52 	53 	54 	55 	56 	57 	58 	59 	60 	61 
62 	63 	64 	66 	69 	71 					

Decorative stitches





















Satin stitches

101 	102 	103 	104 	105 	106 	107 	108 	109 	110 	111 
112 	113 	114 	115 	116 	117 	118 	119 	120 	121 	122 
123 	124 									

































































Cross stitches

125	126	127	128	129	130	131	132			
										

Floral stitches

133	134	135	136	137	138	139	140	141	142	143
										
144	145	146	147	148	149	150	151	152	153	
										

Ornamental stitches

154	155	156	157	158	159	160	161	162	163	164
										
165	166	167	168	169	170	171	172	173	174	175
										
176	177	178	179	180	181	182	183	184	185	186
										
187	188	189	190	191	192	193	194	195	196	197
										
198	199	200	201	202	203	204	205	206	207	208
										
209	210	211	212	213	214	215	216	217	218	
										

Novelty

219	220	221	222	223	224	225	226	227	228	229
230	231	232	233							

Quilt stitches

1001	1002	1003	1004	1005	1006	1007	1008	1009	1010	1011
1012	1013	1014	1015	1016	1017	1018	1019	1020	1021	1022
1023	1024	1025	1026	1027	1028	1029	1030	1031	1032	1033
1034	1035									

Index

A

Activating the bobbin thread indicator	43
Activating the upper thread indicator.....	43
Adjusting the brightness of the display.....	44
Adjusting the presser foot pressure	27
Adjusting the presser position via the knee lifter	25
Adjusting the sewing light	44
Adjusting the upper thread tension	38
Alphabet.....	75
Attaching the FHS knee lifter	20
Attaching the presser foot sole	25
Attaching the seam guide	26

B

Back to default setting	45
Buttonholes	77

C

Calibrating the display	44
Calling up the Creative Consultant.....	47
Changing the needle	27
Changing the presser foot holder.....	25
Changing the stitch plate.....	28
Checking the firmware version.....	45
Cleaning the feed dog	86
Cleaning the hook	86
Combination mode.....	54

D

Decorative stitches	73
Dual Feed (DF)	50

E

Environmental Protection	6
Error messages.....	92
Explanation of symbols	7

F

Fabric thickness measurement	42
Feed dog up/down.....	24

I

Indicating the presser foot sole in the user interface.....	26
Inserting thread spool	22

M

Maintenance and cleaning	86
--------------------------------	----

N

Needle stop up/down (permanent).....	28
Needle, Thread, Fabric	16
Needle/thread combination.....	18

O

Overview Stitch patterns	95
--------------------------------	----

P

Positioning the spool disc.....	21
Practical stitches.....	60
Programming the securing stitches.....	38

Q

Quick reverse	41
Quilting	83

R

Raising/Lowering the needle	21
Regulating the speed	51
Remove the presser foot sole	25

S

Safety Instructions.....	4
Saving a stitch pattern combination	57
Second spool pin	22
Selecting a stitch pattern.....	49
Setting the display color.....	43
Sound on/off	44
stitch plate in the user interface	29

T

Technical data.....	94
Threading preparation	30
Threading the bobbin thread	36
Threading the double needle	33

Threading the upper thread	30
Troubleshooting.....	89

U

Using a spool net.....	22
Using eco mode.....	47

W

Winding the bobbin thread.....	35
--------------------------------	----



www.mybernette.com/b77

© BERNINA International AG
Steckborn CH, www.bernina.com