



View this machine and more at:

<https://www.thesewingstudio.co.uk>



b64
AIRLOCK



User manual

bernette

SWISS DESIGN

Table of Contents

1	IMPORTANT SAFETY INSTRUCTIONS	5		
	Important information	7		
2	My bernette Overlocker	9		
2.1	Machine overview	9		
	Front view	9		
	Overview - Needle area	10		
	Overview Presser Foot	11		
	Overview - Looper area	12		
	Overview Threading area	13		
	Overview - Side panel	14		
	Symbols	15		
2.2	Overview - standard accessories	16		
	Included accessories	16		
	Accessories behind the Threader Cover	17		
	Accessories Box	18		
3	Setting up the machine	20		
3.1	Working area	20		
3.2	Connection and Switching on	20		
	Connecting the machine	20		
	Switching the machine and sewing light on/off	21		
3.3	Foot control	21		
	Press the foot control	21		
3.4	Handwheel	21		
3.5	Machine covers	22		
	Open/close the Threader Cover	22		
3.6	Thread stand	22		
	Attaching the Thread Stand	22		
	Preparing the Thread Guide	23		
	Attaching the spool stabilizer	23		
	Place the spool disc	24		
	Using the spool net	24		
3.7	Presser foot	25		
	Positioning the presser foot up/down	25		
	Lifting the presser foot up/down with the knee lifter	25		
	Changing the presser foot	26		
3.8	Needle area	27		
	Needle Holder	27		
	Changing the needle	27		
	Threading the needle manually	29		
	Positioning the Needles up/down	29		
3.9	Sewing Assistance	30		
	Using the thread cutter	30		
	Attaching/removing the knee lifter	30		
	Attaching/removing the cut-offs bin	31		
	Attaching/removing the freearm cover	31		
	Attaching/removing the Slide-on Table	32		
	Attaching the Decorative Threads Guide	32		
4	Sewing start	33		
4.1	Check before starting to sew	33		
4.2	Selecting the fabric	33		
4.3	Selecting the thread	33		
	Needle Thread	34		
	Looper Thread	34		
4.4	Selecting the needle	35		
	Detect defective needles	36		
	Needle Overview	36		
4.5	Fixing fabric layers	36		
5	Stitch	37		
5.1	Stitch type	37		
	Overlockstitch	37		
	Select stitch by application	38		
5.2	Stitch Chart	41		
6	Machine settings	43		
6.1	Setting the knife	43		
	Knife On/Off	43		
	Setting the Cutting Width	44		
6.2	Upper Looper Converter hooked in/hooked out	45		
6.3	Rolled Hem Selection Lever «N/R»	46		
	Overlocking «N»	46		
	Rolled hem «R»	46		
6.4	Setting the mtc Micro Thread Control	47		
6.5	Setting the Presser Foot Pressure	48		
6.6	Adjusting the stitch width	48		
	Changing the stitch width via the needle position	48		
	Changing the stitch width via the Cutting Width	48		
6.7	Adjusting the thread tension	49		

Table of Contents

6.8	Adjusting the Differential Feed	49	10	Appendix	77
	Default value "1"	50	10.1	Storing and transporting the machine	77
	Gathering "1.5 – 2"	50		Storing the machine	77
	Stretching "0.6"	51		Transporting the machine	77
6.9	Setting the Stitch Length	52	10.2	Maintenance and cleaning the machine	77
7	Threading	53		Cleaning the machine	77
7.1	Threading preparation	53		Cleaning the Looper Area	78
7.2	Air Threader	54		Cleaning the air threader pipes	79
	Threading the Looper Threads UL/blue, LL/red	55		Cleaning the suction feet	79
	Threading the Looper Thread with an auxiliary thread ..	57		Oiling the machine	80
	Using the Threading Wire	57	10.3	Troubleshooting	81
7.3	Threading the needle thread	58	10.4	Specifications	82
	Threading the Right Needle Thread RN/green	58			
	Threading the Left Needle Thread LN/yellow	59			
7.4	Thread change	60			
	Knotting thick thread	60			
	Changing the needle thread	61			
	Changing the looper thread	61			
8	Sewing test	62			
8.1	Performing a sewing test for an overlock stitch	62			
8.2	Optimizing stitches	62			
	4-/3-thread Overlock	63			
	3-Thread Narrow Seam	64			
	3-thread super-stretch / 2-thread wrapped overlock	65			
	3-thread flatlock	66			
	3-thread rolled hem / 3-thread picot stitch	67			
	2-thread rolled hem	68			
	2-thread flatlock / 2-thread overlock	69			
9	Practical overlocking	70			
9.1	Securing overlock stitches	70			
	Sewing in the overlock chain at the start of the seam ..	70			
	Sewing in the overlock chain at the end of the seam ..	70			
	Securing overlock stitches	71			
	Knotting the overlock chain	71			
9.2	Undoing overlock stitches	71			
9.3	Flatlock	72			
9.4	Gathering	73			
	Increasing the differential feed	73			
	Pulling the needle thread	73			
9.5	Sew outer corners	74			
9.6	Sewing inner corners	75			
9.7	Sewing inner curves	75			
9.8	Sew outer curves and circles	76			

IMPORTANT SAFETY INSTRUCTIONS

Please be aware of the following basic safety instructions when using your machine. Before using this machine, read instruction manual carefully.

DANGER!

To reduce the risk of electrical shock:

- Never leave the machine unattended as long as it is plugged in.
- Always unplug the machine from the electrical outlet immediately after using and before cleaning.

Protection against LED radiation:

- Do not view the LED light directly with optical instruments (e.g. magnifier). The LED light corresponds with protection class 1M.
- When the LED light is damaged or defective, contact your bernette specialist dealer.

To reduce the risk of injury:

- Caution: moving parts. To reduce risk of injury, switch the machine off before servicing. Close the covers before operating machine.

WARNING

To reduce the risk of burns, fire, electric shock or injury to persons:

- To operate the machine always use the supplied power cable. USA and Canada only: Do not connect power plug NEMA 1-15 to circuits exceeding 150 volt-to-ground.
- This machine may only be used for the purpose described in this instruction manual.
- Only use the machine in dry rooms.
- Do not use the machine in a damp condition or in a damp environment.
- Do not use the machine as a toy. You must take extra care if the machine is being used by children or in the vicinity of children.
- This machine may be used by children eight years of age and older as well as persons with restricted physical, sensory or mental capacities or lack of experience and knowledge under supervision or having received instruction on the safe use of the machine and the resulting hazards.
- Children must not play with the machine.
- Cleaning and maintenance work must not be carried out by children without supervision.

- Do not use this machine if the cable or plug is damaged, the machine is not functioning correctly, it is dropped or becomes damaged or falls in water. Never operate this machine if it has a damaged cord or plug, if it is not working properly, if it has been dropped or damaged, or dropped into water. Contact the nearest authorized bernette dealer to arrange further details.
- Only use accessories recommended by the manufacturer.
- Do not use this machine if the ventilation openings are blocked. Keep all ventilation openings and foot control free of lint, dust and loose cloth.
- Do not insert any objects into the openings of the machine.
- Do not place any objects on the foot control.
- Always use the machine with a foot control of this type .
- Do not use the machine anywhere that oxygen or propellant products (sprays) are being used.
- The knife cover insert or coverstitch insert must be attached continuously while operating the machine.
- Keep fingers away from all rotating and moving parts. Special care is required in the needle area, the looper and the knife.
- Neither pull nor push the fabric while sewing. This can cause needle breakage.
- Turn power switch to «0» when making any adjustments in the needle area, such as threading the needle or changing the needle or the presser foot.
- Never use damaged needles.
- Always use the original bernette stitch plate. The wrong stitch plate can cause needle breakage.
- To disconnect, turn power switch to "0" and then remove the plug from the outlet. Always pull on the plug and not the cable.
- Disconnect the plug before removing or opening the covers, oiling the machine or performing any cleaning or maintenance work described in this instruction manual.
- This machine is double-insulated (except for USA, Canada and Japan). Use only genuine replacement parts. See instructions for Servicing of double-insulated products.

Important information

Availability of the instruction manual

The short manual is part of the machine.

- Keep the short manual of the machine in a suitable place near the machine and have it ready for reference.
- A detailed instruction manual can be downloaded from www.mybernette.com.
- When passing on the machine to a third party, enclose the short manual of the machine.

Proper use

Your bernette machine is conceived and designed for private household use. It answers the purpose for overlocking fabrics as it is described in this instruction manual. Any other use is not considered proper. BERNINA assumes no liability for consequences resulting from improper use.

Equipment and scope of delivery

Example images are used in these operating instructions for the purposes of illustration. The machines shown in the images and the accessories shown therefore do not always match the actual items included with your machine. The supplied accessory can vary depending on the country of delivery. You can acquire any accessories mentioned or shown that are not included in the scope of delivery as optional accessories from a specialist bernette dealer. Further accessories can be found at www.mybernette.com.

For technical reasons and in order to improve the product, changes may be made to the equipment of the machine and the scope of delivery at any time and without prior notice.

Maintenance of double-insulated products

In a double-insulated product, two systems of insulation are provided instead of grounding. No grounding means is provided on a double-insulated product nor should a means for grounding be added to the product. Servicing a double-insulated product requires extreme care and knowledge of the system and should only be done by qualified service personnel. Only original spare parts should be used for service and repairs. A double-insulated product is marked with the words: «Double-Insulation »or «double-insulated».

 The symbol may also be marked on the product.

Environmental Protection

BERNINA is committed to the protection of the environment. We strive to minimize the environmental impact of our products by continuously improving product design and our technology of manufacturing.



The machine is labeled with the symbol of the crossed-out wastebin. This means that the machine should not be disposed of in household waste when it is no longer needed. Improper disposal can result in dangerous substances getting into the groundwater and thus into our food chain, damaging our health.

The machine must be returned free of charge to a nearby collection point for waste electrical and electronic equipment or to a collection point for the reuse of the machine. Information on the collection points can be obtained from your local administration. When purchasing a new machine, the dealer is obliged to take back the old machine free of charge and dispose of it properly.

If the machine contains personal data, you are responsible for deleting the data yourself before returning the machine.

Explanation of symbols



Designates a high-risk hazard which can lead to serious injuries or potentially even death if not avoided.



Designates a medium-risk hazard which can lead to serious injuries if not avoided.



Designates a low-risk hazard which can lead to minor or moderate injuries if not avoided.

NOTICE

Designates a hazard which can lead to material damage if not avoided.



You will find **tips** from bernette **sewing experts** next to this symbol.

2 My bernette Overlocker

2.1 Machine overview

Front view

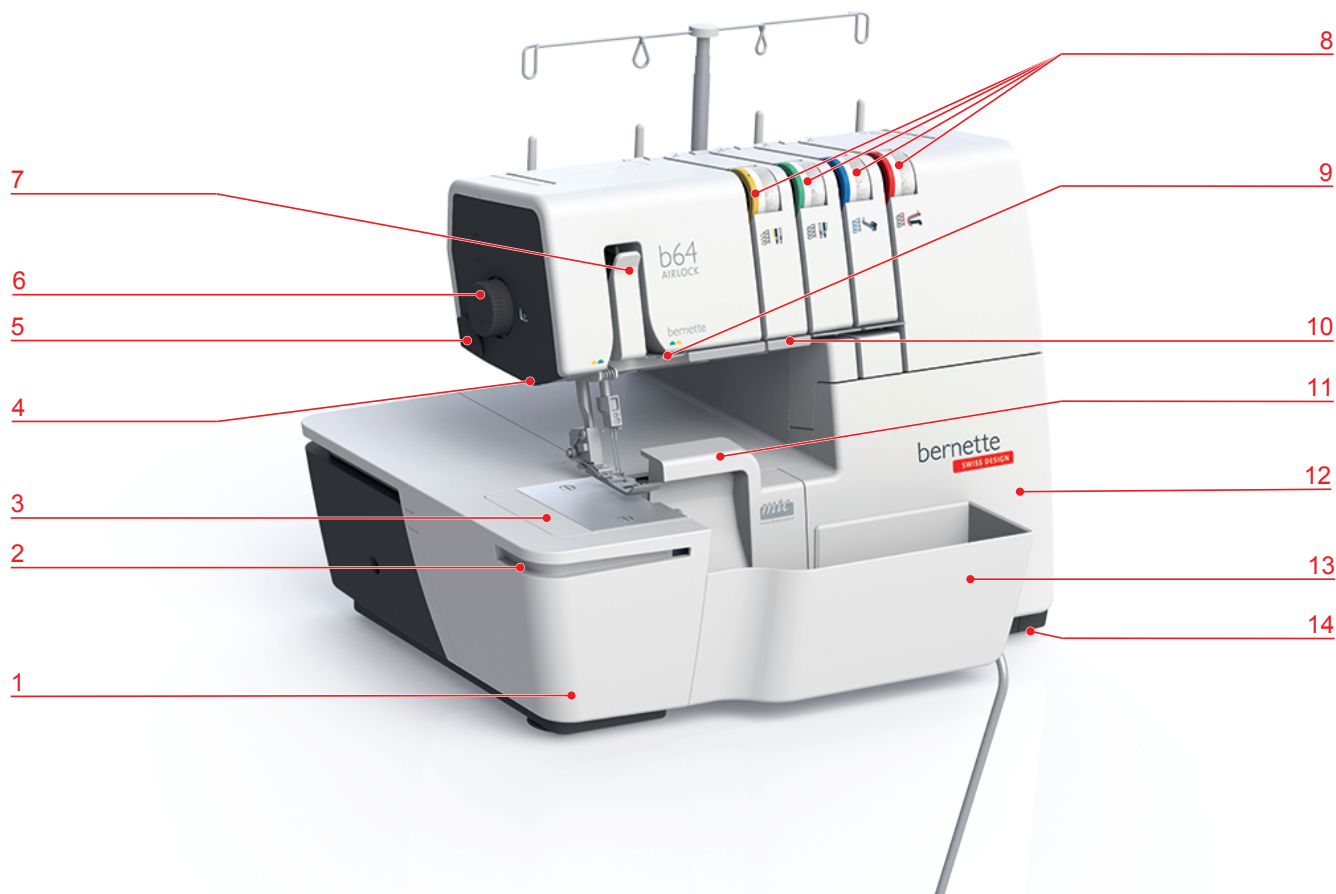

- | | | | |
|---|-----------------------------------|----|---------------------------|
| 1 | Freearm Cover | 8 | Thread Tension Adjustment |
| 2 | Guide Rail | 9 | Thread Deflection Fingers |
| 3 | Freearm | 10 | Thread Guiding Plate |
| 4 | Sewing Light (LED) | 11 | Knife Cover Insert |
| 5 | Thread Cutter | 12 | Threader Cover |
| 6 | Presser Foot Presser Wheel | 13 | Cut-offs Bin |
| 7 | Needle Thread Take-up Lever Cover | 14 | Suction Feet |

Overview - Needle area

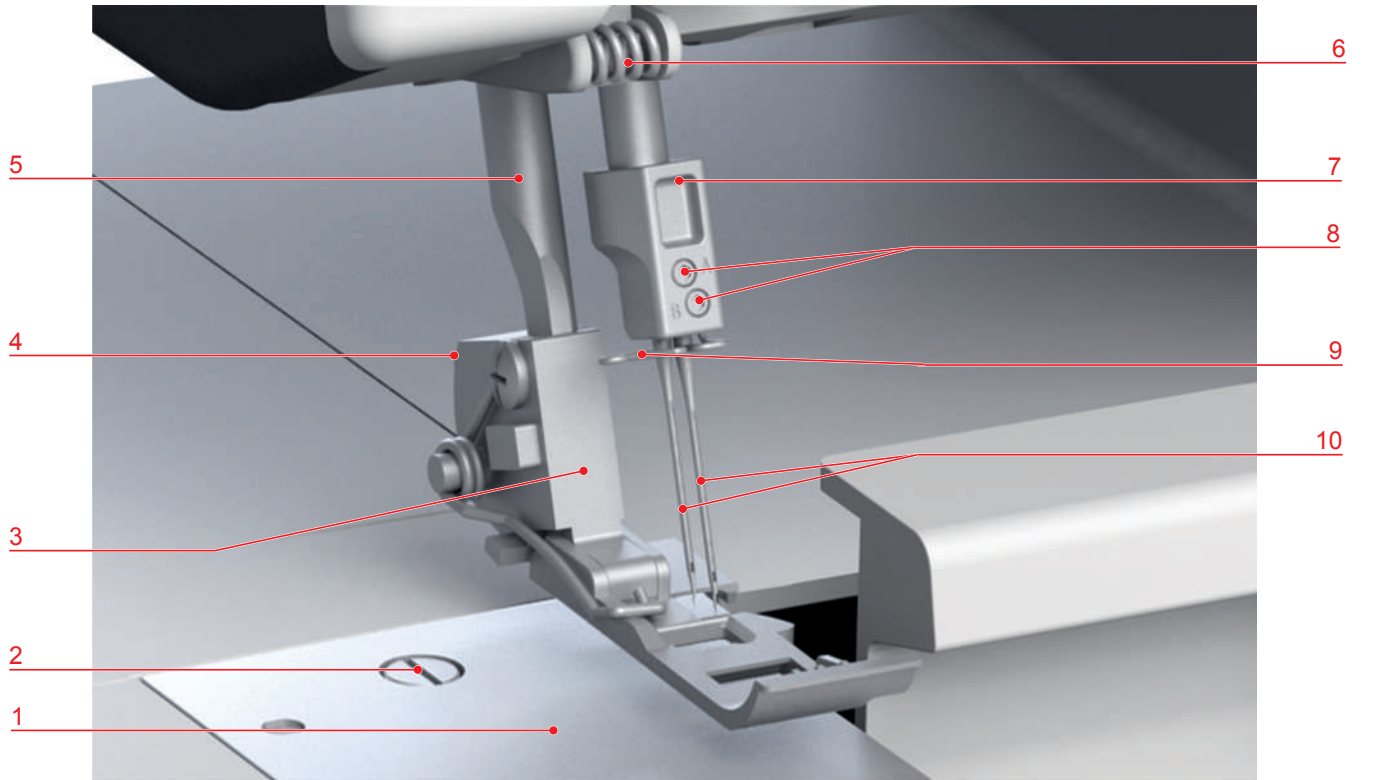

- | | | | |
|---|----------------------------------|----|-----------------------------------|
| 1 | Stitch Plate | 6 | Thread Guide on the Headframe |
| 2 | Stitch Plate Screw | 7 | Needle Holder |
| 3 | Standard Overlock Presser Foot | 8 | Needle Screws |
| 4 | Presser Foot Release Lever (red) | 9 | Thread Guide on the Needle Holder |
| 5 | Presser Foot Bar | 10 | Needles ELx705 |

Overview Presser Foot

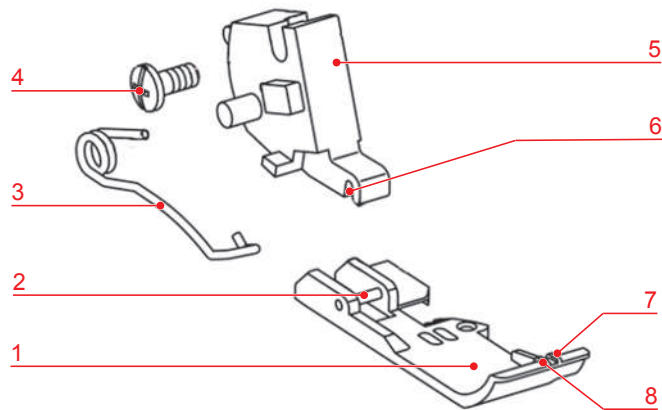

- | | | | |
|---|-----------------------|---|----------------------------|
| 1 | Presser Foot Sole | 5 | Presser Foot Shaft |
| 2 | Presser Foot Sole Pin | 6 | Shaft groove |
| 3 | Presser Foot Spring | 7 | Right Needle position (RN) |
| 4 | Fixing screw | 8 | Left Needle position (LN) |

Overview - Looper area

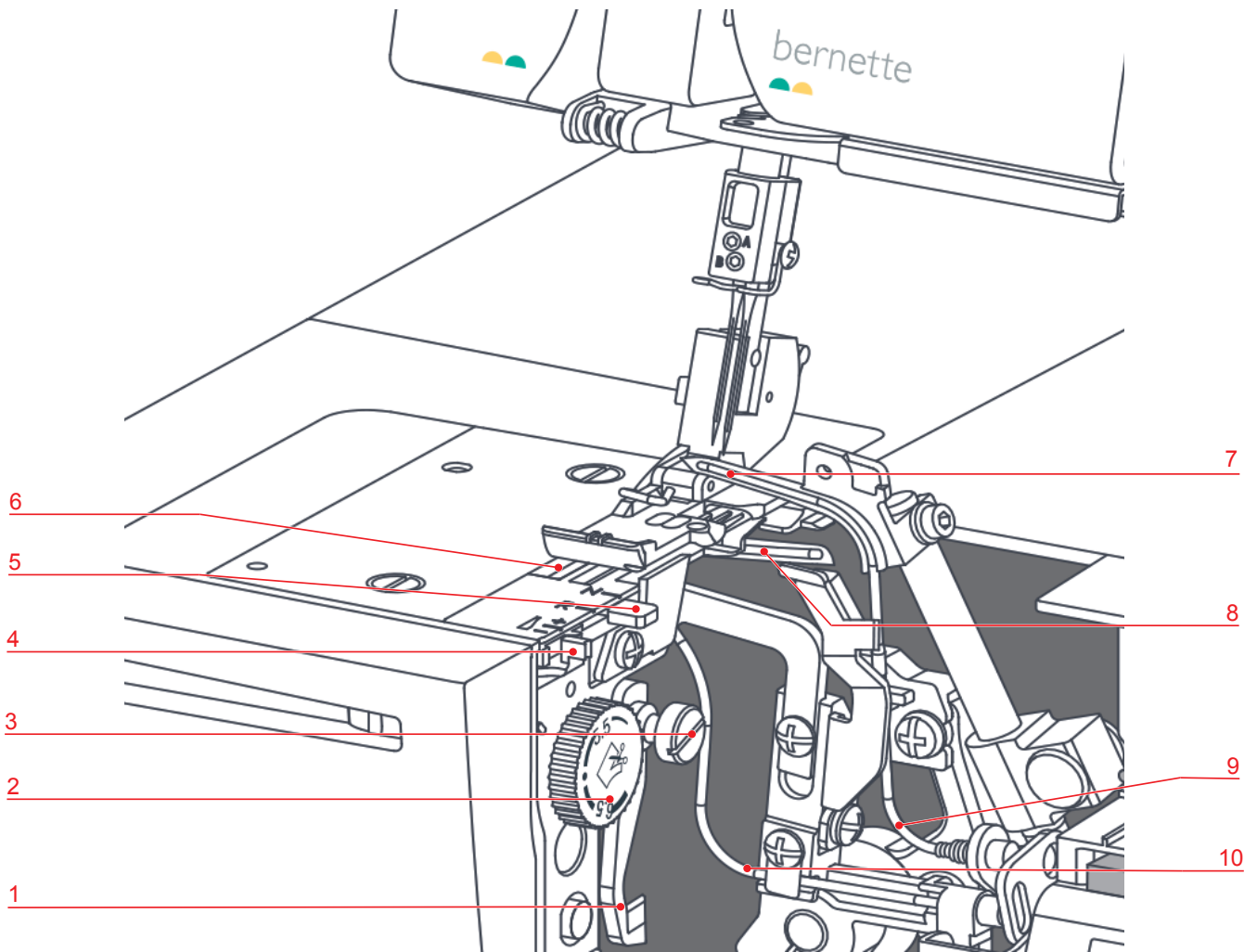

- | | | | |
|---|-------------------------------|----|--------------------------------|
| 1 | Knife | 6 | Feed Dog |
| 2 | Cutting Width Dial | 7 | Upper Looper |
| 3 | Knife On/Off | 8 | Lower Looper |
| 4 | mtc Micro Thread Control Dial | 9 | Upper Looper Air Threader Pipe |
| 5 | Rolled Hem Selection Lever | 10 | Air Threader Duct Lower Looper |

Overview Threading area

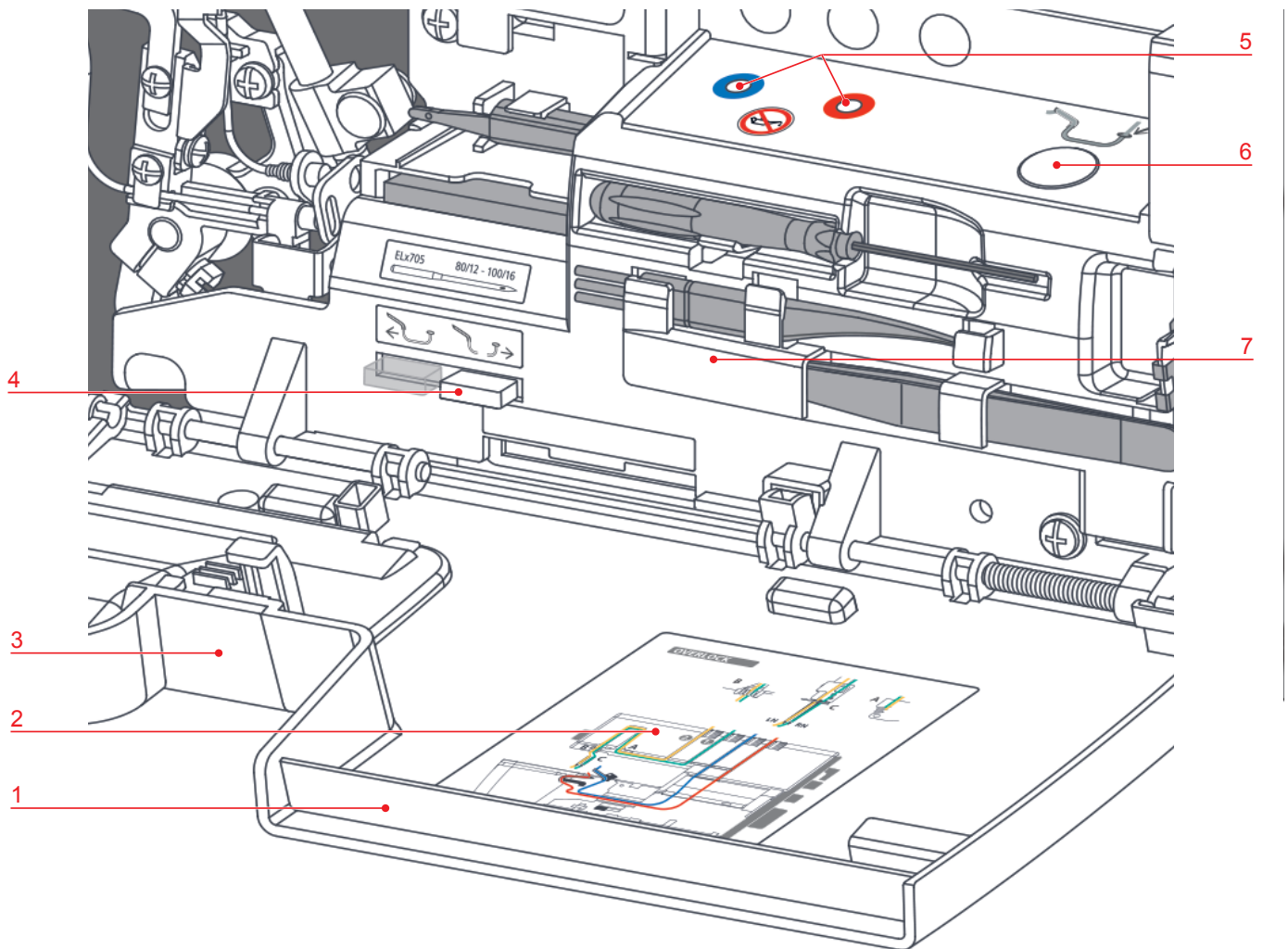

- | | | | |
|---|-------------------------------|---|-----------------------------------|
| 1 | Threader Cover | 5 | Air Threader Nozzles |
| 2 | Threading Chart | 6 | Air Threader Lever |
| 3 | Knife Cover Insert | 7 | Accessories in the Threader Cover |
| 4 | Air Threader Connector On/Off | | |

















Overview - Side panel



- | | | | |
|---|--------------------------|----|----------------------------------|
| 1 | Carry Handle | 8 | Differential Feed Dial |
| 2 | Retractable Thread Guide | 9 | Handwheel |
| 3 | Spool Pin | 10 | Air Vents |
| 4 | Spool Pin | 11 | Foot control-/ power connection |
| 5 | Needle Pad | 12 | Power Switch |
| 6 | Presser Foot Lifter | 13 | Connection for Knee Lifter (FHS) |
| 7 | Stitch Length Setting | | |

Symbols









The symbols are for your guidance and give assistance when adjusting settings and threading the machine.

	LN	Left Needle Thread
		Thread path yellow
	RN	Right Needle Thread
		Thread path green
	UL	Upper Looper Thread
		Thread path blue
	LL	Lower Looper Thread
		Thread path red
	ULC	Upper Looper Converter
	CW	Cutting Width
	SL	Stitch Length
	DF	Differential Feed
	N/R	Rolled Hem Selection Lever
	mtc	mtc Micro Thread Control
		Presser Foot Pressure
		Air Threader Lever
		Air Threader Connector On/Off

2.2 Overview - standard accessories

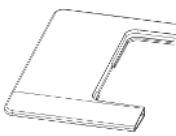

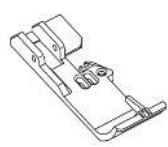

Included accessories

Visit www.mybernette.com for more accessories information.

Illustration	Name	Purpose
	Power Cable and Foot Control Cable	To connect the machine with the power supply system and the Foot Control.
	Cut-offs Bin	To collect resulting scraps.
	Knife cover insert	To protect the fingers and to deflect the fabric cut-offs during the sewing process.
	Freearm cover	To extend the work surface.
	Slide-on table	To increase the sewing surface.
	Free Hand System (FHS)	To raise and lower the presser foot.
	Overlock Foot	For all Overlock Stitches. For general sewing projects.
	Retractable Thread Guide	For an even unwinding of the thread from the thread cones.

Accessories behind the Threader Cover

The most often used accessories while sewing are stored behind the Threader Cover on the machine, so it is always quickly at hand.

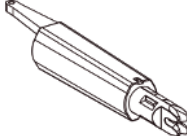
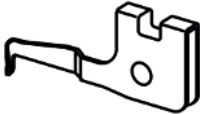
Illustration	Name	Purpose
	Needle Set ELx705 CF (3 x No. 80, 2 x No. 90)	For the most frequently used Overlock applications, in various needle sizes.
	Screwdriver	To loosen or tighten the fixing screws on the needle holder.
	Brush	To clean the feed dog and the looper area.
	BERNINA tweezers	To grip the threads in narrow positions.
	Needle threader/insertor	To manually thread, insert and remove the needle.
	Upper Looper Converter	To cover the Upper Looper. For sewing 2-thread overlock and the 3-thread super-stretch stitch.

Accessories Box

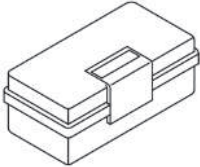

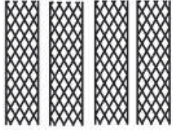





Illustration	Name	Purpose
	Accessories box	To store the supplied accessories as well as the optional accessories.
	Overlocker oil	For oiling the looper components. (see page 80)
	Spool Stabilizers (4 x)	To stabilize the thread cone on the Thread Stand.
	Spool Nets (4 x)	To support even unwinding of nylon, rayon, silk or metallic threads from the spool.
	Spool Discs (4 x)	To support an even unwinding of the thread from small thread spools.
	Screwdriver	To loosen/tighten the Stitch Plate Screws.
	Knife	To exchange the knife.
	Threading wire	To thread the looper threads manually in the air threader pipe.

Illustration	Name	Purpose
	Decorative Thread Guide	To sew with decorative threads for particularly wide and long stitches, for seams and edge finishing.

3 Setting up the machine

3.1 Working area

A stable table with a secure stand is a good prerequisite for optimal sewing results. Ergonomics around the sewing table is an important point to protect the muscles and joints of the back, shoulder, arms and hands. The recommendation for this includes matching the height of the table and the body posture. Avoid staying in the same position for long periods.

- > Place the machine on a stable table.
- > Before operating the machine again after storage, leave the machine unpacked for approx. 1 h at room temperature.

Correct sitting position

- > Sit comfortably in front of the machine.
- > Hold the arms 90 ° across the table, with your fingertips to the machine.
 - The fingertips should touch the Stich Plate.

3.2 Connection and Switching on

Connecting the machine

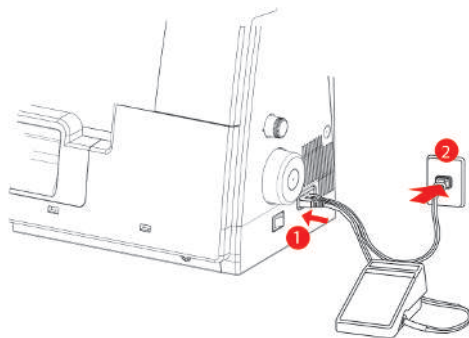

- > Insert the plug (1) of the Power Cable and the Foot Control cable into the connection.
- > Insert the plug (2) of the Power Cable and the Foot Control cable into the socket outlet.

Use of the power cable (only USA/Canada)

The machine has a polarized plug (one contact is wider than the other). To reduce the risk of electric shock, the plug can only be plugged into the socket in one way. If the plug does not fit into the socket, turn the plug. If it still does not fit, contact an electrician to install an appropriate outlet. Do not modify the plug in any way.

Switching the machine and sewing light on/off

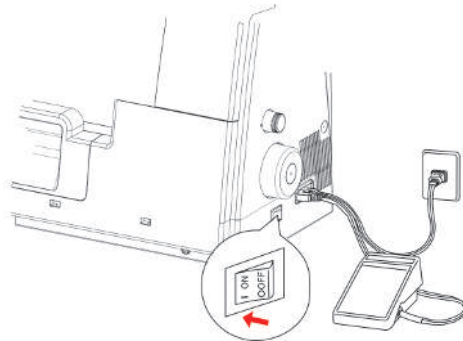

- > Set the Power Switch to «I».
 - The machine and the Sewing Light switch on.
- > Turn the Power Switch to «0».
 - The machine switches off.
 - The sewing light switches off time-delayed to the machine.

3.3 Foot control

Press the foot control

By operating the Foot Control the needle and knife move. The sewing speed can be infinitely adjusted by more or less pressure on the foot control.

- > To start the sewing process, increase the pressure on the Foot Control.
- > To stop the sewing process, reduce the pressure on the Foot Control.

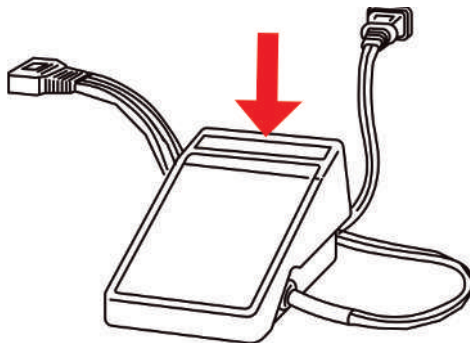

3.4 Handwheel

By turning the Handwheel counterclockwise, several activities can be performed.

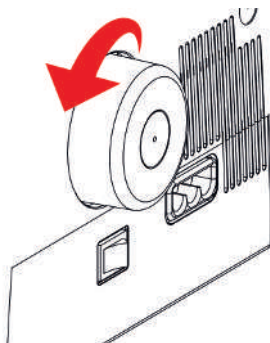

- Slow, precise placement of the needle
- Moving the Loopers
- Moving the Knife
- Mechanical coupling of the Air Threader

3.5 Machine covers

The machine covers protect against injuries caused by moving components and prevent fragile elements from being damaged. All covers must be fitted or closed prior to sewing.

- Needle Threader Cover
- Knife Cover Insert

Open/close the Threader Cover

The Threader Cover protects the inserted looper threads during sewing operations.

- > To open the Threader Cover, push it to the right and swing it forward.

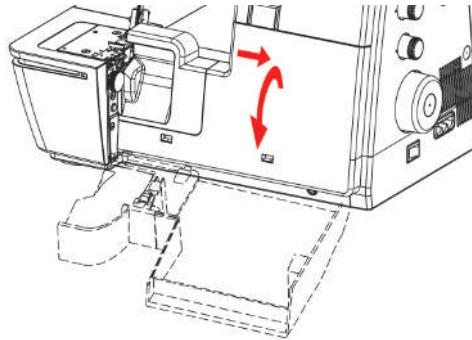

- > To close the Threader Cover, swing the Threader Cover up until it clicks into place to the left.

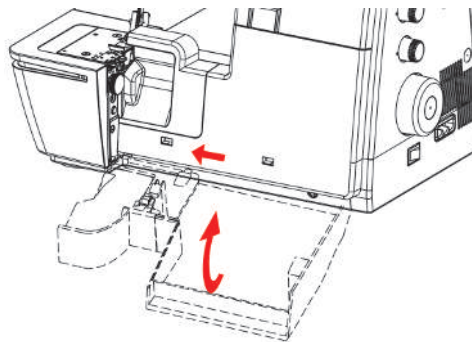

If the Threader Cover cannot be closed completely, the Air Threader Connector is still switched on.

3.6 Thread stand

The Thread Stand is placed on the back of the machine. Thread cones, foot spools or household spools of all sizes can be placed on the Thread Stand.

Attaching the Thread Stand

- > To fit the Thread Stand, press the connection points from behind towards the front of the machine (1) and snap them into place on the right (2) of the machine.

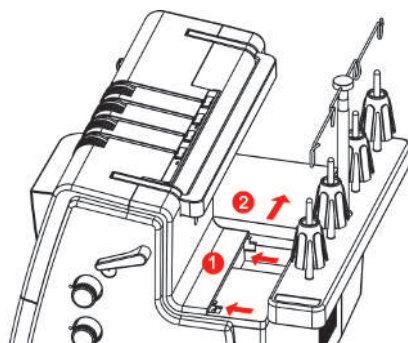

Preparing the Thread Guide

The Thread Guide ensures a clean unwinding of the thread from the thread cones. Each thread is guided through a Thread Guide Wire located directly above the thread cone.

- > To attach the Retractable Thread Guide, insert it into the opening provided in the Thread Stand until it clicks.

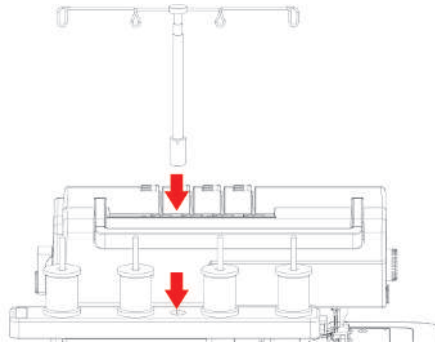

- > Hold the Thread Guide and pull it up to the stop.
- > Turn the Thread Guide to the left and right until the two positioning pins engage.
 - The outer Thread Guide Wires are parallel to the machine front.

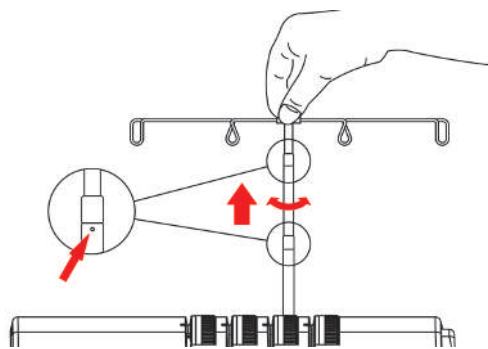

- > When not in use, retract the Thread Guide with a little pressure downwards.

Attaching the spool stabilizer

For large thread cones, the spool stabilizer serves to stabilize the thread cone on the spool pin.

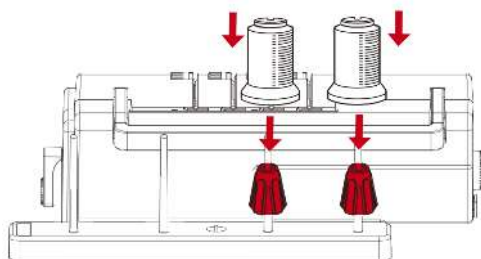

- > For extremely conical spools, place the spool stabilizer onto the spool pin with the pointy end up.
- > For slightly conical spools, place the spool stabilizer onto the thread spool pin with the pointy end down.

Place the spool disc

The Spool Disc ensures the stability of the thread spool and the even unwinding of the thread.

- > Place the thread spool on the Thread Stand.
- > Push the flat side of the Spool Disc over the Spool Pin to the thread spool.

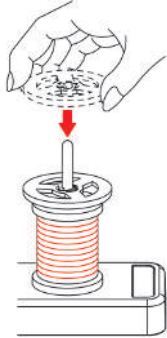

Using the spool net

The spool net prevents the thread from sliding down from the thread spool and is recommended for special threads.

- Thin threads, which slide easily off the spool
- Nylon, rayon, silk threads or effect and metallic threads

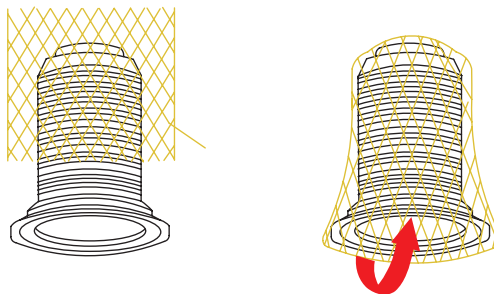

- > Put the spool net over the thread spool from above and pull the thread end upwards.

3.7 Presser foot

Positioning the presser foot up/down

The lifted presser foot allows you to place the sewing project under the presser foot. The lowered presser foot is a prerequisite for starting to sew.

- > Lift the Presser Foot Lifter until it engages.
 - The presser foot remains in the upper position.
 - The Thread Tension is released.

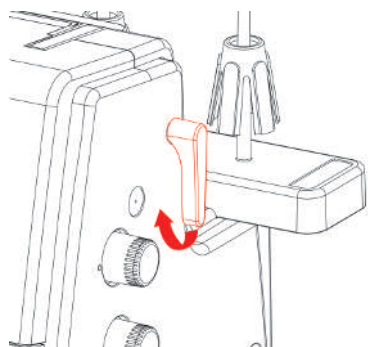

- > Lower the Presser Foot Lifter.
 - The machine is ready for sewing.
 - The Thread Tension is active.

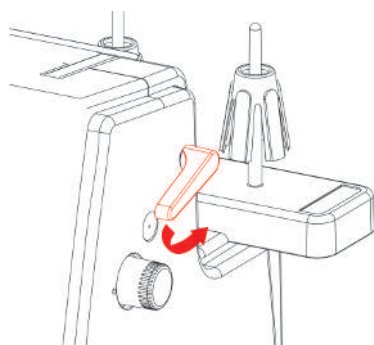

Lifting the presser foot up/down with the knee lifter

Temporarily lifting the presser foot using the Free Hand System allows the sewing project to be repositioned using both hands.

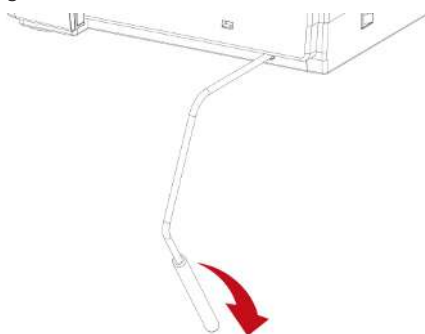

Prerequisite:

- The Knee Lifter of the Free Hand System is attached. (see page 30)
- > To raise the presser foot, press the Knee Lifter with the knee out to the right and hold it in place.
- > To lower the raised presser foot, slowly release the pressure on the Knee Lifter.
- > To lower the already engaged presser foot, press the knee lifter all the way to the right and release slowly.

Changing the presser foot

Prerequisite:

- The needles are in the top position.
 - The presser foot is raised.
- > Press the Release Button on the rear side of the Presser Foot Shaft.
- The presser foot is released.

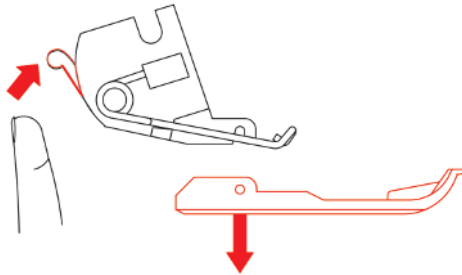

- > Lift the Presser Foot Spring slightly and remove the presser foot.
- > Lift the Presser Foot Spring slightly and place the new presser foot beneath the shaft groove so that the shaft groove lies exactly above the Presser Foot Pin.
- > Lower the Presser Foot Shaft carefully until the shaft groove engages with the Presser Foot Pin.

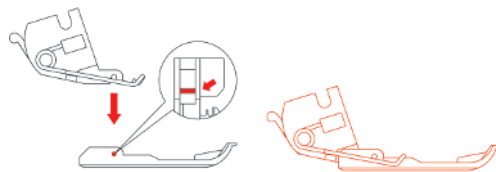

- > Raise the presser foot.

3.8 Needle area

Needle Holder

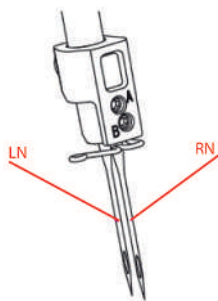

Needles for Overlock Stitches



«LN» Left Needle for Overlock Stitches.



«RN» Right Needle for Overlock Stitches.

Changing the needle

The use of the Needle Inserter is recommended and prevents the needle from falling into the Feed Dog area. (see page 17)

The Needle Holder Screws must always be tightened, even if no needles are inserted, this prevents the Needle Holding Screws from falling out because of vibration. Correctly inserted needles are not at the same height.

NOTICE

Damage due to excessive tightening of the screws

The threads of the Needle Holder may be damaged. A repair by the Authorized bernette dealer is required.

> Do not overtighten the Needle Screws.

The Needle Holder can hold two needles. The machine is designed for needles of the ELx705 system. Needle sizes between 80 – 100 are to be used for this machine. (see page 35)

Prerequisite:

- The needles are in the top position.

- > Guide the Needle Inserter from below over the needle and loosen the Needle Screw using the supplied Screwdriver.

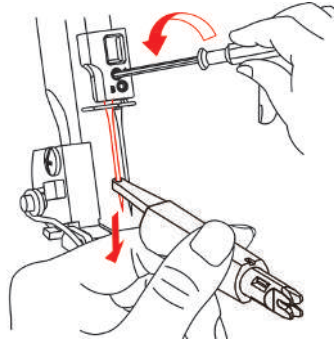

- > Pull the needle downwards to remove.
- > Insert the new needle into the Needle Inserter with the flat side facing back.

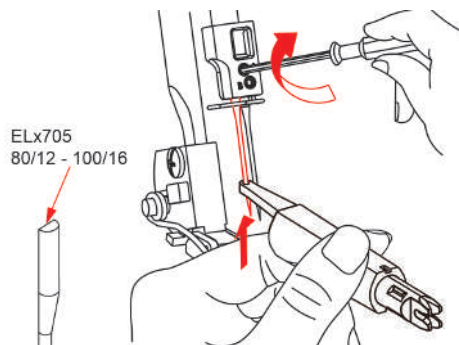

- > Push the needle into the corresponding Needle Holder opening as far as it will go.
- > Tighten the Needle Holder Screws.

Needle Pad

The Needle Pad is used to store needles that are not being used.



Threading the needle manually

With the Needle Threader every needle can be threaded easily.

- > Hold the Needle Threader with the flat grip side facing up.
- > Pull the thread horizontally through the slot and hold the end of the thread.

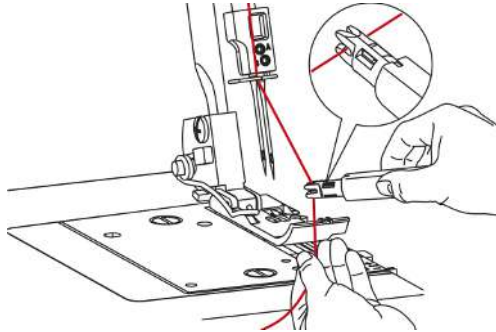

- > Position the Needle Threader with the V-guide at the top of the needle and with little pressure slide along the needle to the eye.

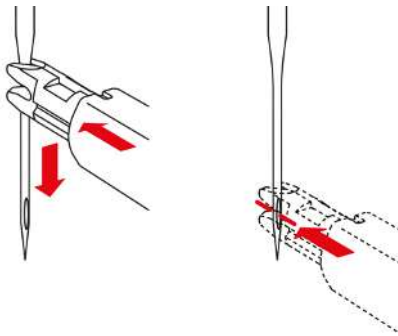

- The metal pin presses the thread through the eye of the needle.
- > Release the pressure on the Needle Threader and remove it from the needle.
 - A thread loop is formed.
- > Pull the thread loop with the end of the Needle Threader to the back.

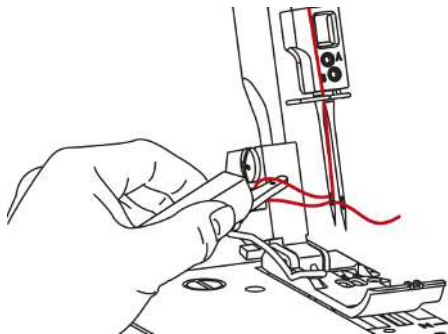

- > Place the thread under the presser foot to the back left.

Positioning the Needles up/down

The Needle Position Up/Down is recommended for various actions.

- to change the needle
- to thread the needle
- to activate the Air Threader Pipes
- to change the presser foot
- > To move the needle manually, turn the Handwheel counter-clockwise until the desired needle position is reached.

3.9 Sewing Assistance

Using the thread cutter

The Thread Cutter is used to cut the threads/thread chain.

- > Pull the threads/thread chain into the thread cutter and downwards.

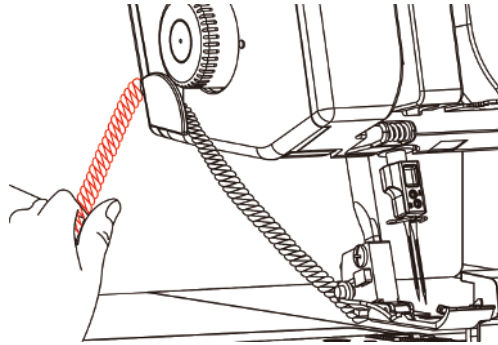

- The threads/thread chains are held after cutting and are ready for sewing.

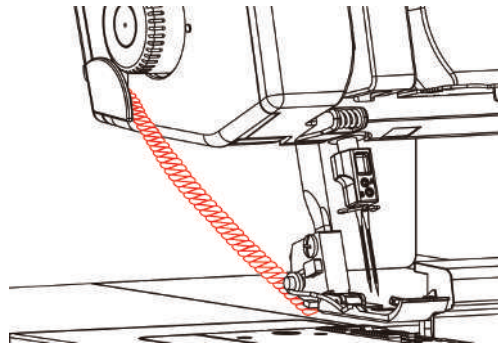

Attaching/removing the knee lifter

Temporarily lifting the presser foot using the Free Hand System allows the sewing project to be repositioned using both hands.

- > To attach the Knee Lifter, push the Knee Lifter Engaging Cam in a horizontal position into the Knee Lifter Connection until it stops.

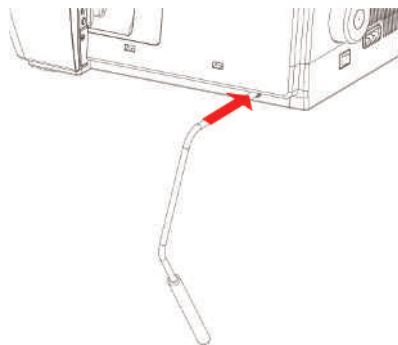

- > To remove the Knee Lifter, pull the Knee Lifter out of the Knee Lifter Connection without swinging the Knee Lifter sideways.

Attaching/removing the cut-offs bin

The Cut-offs Bin catches the fabric scraps during the sewing process.

- > To attach the Cut-offs Bin, hook the Cut-offs Bin into the snap-in opening on the Looper Cover.

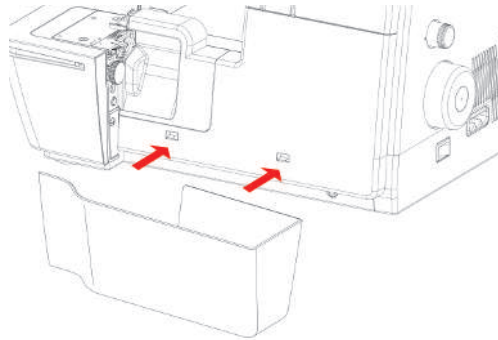

- > To remove the Cut-offs Bin, lift the Cut-offs Bin out of the snap-in opening on the Looper Cover.

Attaching/removing the frearm cover

The freearm is ideal when working with tubular, closed projects such as cuffs, trouser hems or sleeve ends. The freearm cover closes the gap between the stitch plate and the sewing surface.

Prerequisite:

- The slide-on table is removed.
- > To attach the freearm cover, push the freearm cover along the guide rails from the left until it engages.
- > To remove the freearm cover, pull the freearm cover to the left.

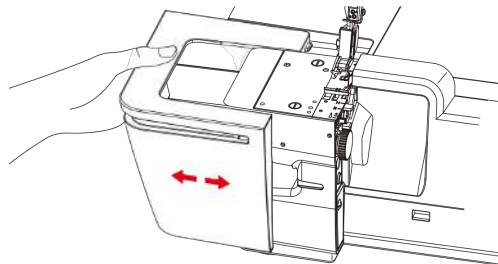

Attaching/removing the Slide-on Table

The Slide-on Table increases the sewing surface, especially helpful with larger sewing projects.

Prerequisite:

- Freearm Cover is attached.
- > To attach the Slide-on Table, push the Slide-on Table along the Guide Rails from the left until it engages.

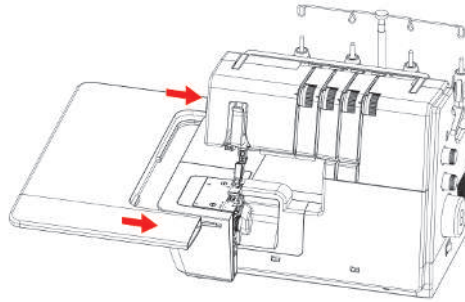

- > To remove the Slide-on Table, press the Release Mechanism (1) of the Slide-on Table and pull the Slide-on Table to the left.

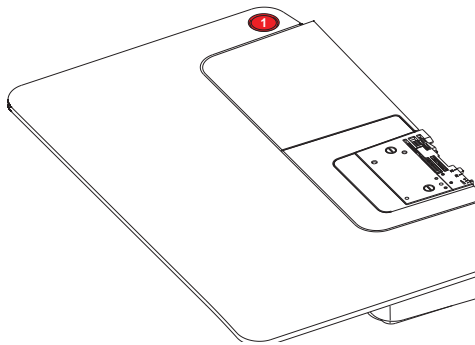

Attaching the Decorative Threads Guide

- > Tension the Decorative Threads Guide slightly and hook it into the left and right recesses in the machine cover.
- > Thread the thread through the Thread Guide Eyelet and insert it along the thread path between the Thread Tension Discs.

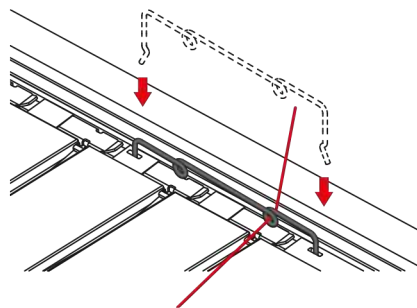

Fitting with thread already inserted

- > Pull the thread out of the Thread Pretension.
- > Attach one end of the Decorative Threads Guide.
- > Thread the thread into the Decorative Threads Guide.
- > Attach the second end of the Decorative Threads Guide.

4 Sewing start

4.1 Check before starting to sew

In order to start a project successfully, the following steps must be performed.

- The machine is switched on and the presser foot is lifted.
 - The fabric and the application have been selected. (see page 33)
 - The thread has been selected. (see page 33)
 - The needle size matches with the thread type and the sewing project. (see page 35)
 - The stitch has been selected. (see page 41)
 - The machine settings based on the stitch selection have been performed. (see page 41) / (see page 43)
 - Threading has been performed according to the Stitch Chart.
 - All Needle Threads and Looper Threads lie under the presser foot to the back left.
 - Threader Cover is closed.
- > Lower the presser foot.
- > To start the sewing process, press the foot control.
- A thread chain is formed.
 - If no thread chain is formed, the settings on the machine for the stitch must be checked.

4.2 Selecting the fabric

The choice of fabric, in combination with needle, thread and stitch, plays a vital role in achieving the perfect sewing result. The sewing test with the selected fabric is recommended. (see page 62)

4.3 Selecting the thread

A wide range of sewing and special overlock threads are manufactured in various sizes and in different fiber combinations.

- The purchase of quality threads is recommended to achieve good sewing results.
- Use thread cones/spools which are suitable for overlocker machines.

NOTICE

Thread breakage due to incorrect Needle/Thread or Thread/Looper matching

The thread needs to glide smoothly through the respective Thread Guides.

It must be possible to feed the thread through the Looper or the Needle Eye without any resistance.

In the case of thick threads, elongate the stitch length and reduce the Thread Tension.

Needle Thread



Needle size and thread type must be carefully matched. The correct needle thickness depends on the selected thread as well as the fabric being used.

- The fabric type determines the thread type and point form.
- The thread type determines the needle size.

Needle sizes of 80/12 100/16 can be used on the machine.

Thread type	Needle size
Polyester Overlock Thread No. 120	#80 – #100
Polyester Multifilament < No. 120	80 – 90
Wooly Nylon	#80 – #100
Decorative Thread/Yarn	#80 – #100
Metallic Thread	#80 – #100

Check the needle/thread combination

	The needle/thread combination is correct, when the thread fits perfectly into the long groove and goes easily through the needle eye.
	The thread can break and skipped stitches can occur when there is too much clearance in the long groove and the needle eye.
	The thread can break and get stuck when the thread scrapes against the edge of the long groove not fit well into the needle eye optimally.

Looper Thread

A wide variety of thread types can be used as Looper Threads which can be threaded using the Air Threader System.

NOTICE

Damage by coated or waxed threads

Coated or waxed threads may lose some of their coating in the Air Threader Pipes, which results in permanent blocking of the pipes. A repair by the Authorized bernette dealer is required.

Avoid the use of coated or waxed threads.

4.4 Selecting the needle

It is recommended to use the Needle Type ELx705 CF (Chrome Finish) version, as they are more durable. The machine runs most reliably with these needles because of their second groove.

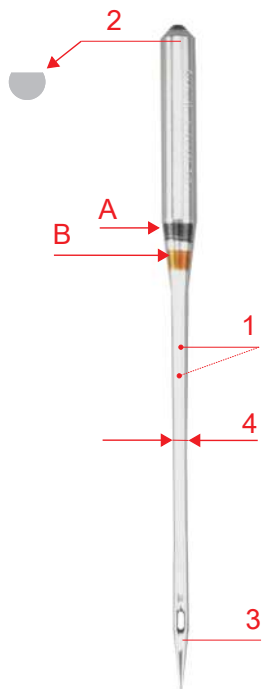

A	Coverstitch Needle ELx705 CF/80
1	two thread grooves
2	705 = Flat shank
3	CF = Chrome Finish
4 / B	80 = Needle size

The needles should be replaced regularly. Only a perfect needle point can achieve a proper stitch.

- Needle size 80: For any common applications. for mid-weight to heavy fabrics.
- Needle size 90: for heavy fabrics.
- Needle sizes >90: In exceptional cases, only for very heavy fabrics.



Detect defective needles

Check the needle before each sewing start and replace it if necessary.



- 1 Bent needle
2 Damaged needle point
3 Blunt needle

Needle Overview

Illustration	Designation	*Size	Description	Material/Application
	Coverstitch Needle ELx705 CF	80/12 90/14 100/16	With slightly rounded point, a second groove and chrome coating	For overlock and coverstitch work.
	Jersey/Coverstitch Needle ELx705 SUK CF	80/12 90/14 100/16	With slightly rounded point, a second groove and chrome coating	For overlocking and coverstitching on multilayer, elastic fabrics.

*Not all needle sizes are available as BERNINA Needles.

4.5 Fixing fabric layers

If several layers of fabric are sewn together, they can be fixed with basting stitches sewn on the sewing machine or by pins.

NOTICE

Damage to the Knife

Pins placed too close to the fabric edge can be caught by the knife. The needle tips can be sheared off or the blade of the knife can be damaged.

Position the pins at an adequate distance from the edge of the fabric.

- > Place the pins approx. 2 cm from the edge of the fabric or remove them continuously while sewing.

5 Stitch

5.1 Stitch type

With this machine different stitch formations can be set. These stitches are achieved by different configurations of needles and mechanical settings.

Overlockstitch

The 3- and 4-thread overlock are considered standard Overlock Stitches for sewing two layers of fabric together, for finishing cut edges, e. g. facings, hem edges and seam allowances that are ironed apart.

The 2-thread overlock is ideal for finishing a fabric edge.

4-Thread Overlock

The 4-Thread Overlock is the most durable stitch thanks to the safety seam. The left and right overlock needle thread as well as the upper and lower looper thread are required for this stitch. The overlock needle threads form two parallel stitch rows, which on the front side look like step stitch rows of a sewing machine. On the wrong side, the overlock needle threads form «dots» to catch the under looper thread when the fabric is pierced, whereby the right overlock needle thread also serves as a safety seam.

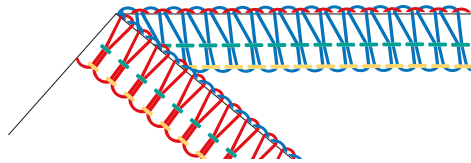

3-Thread Overlock

The 3-Thread Overlock is usually stretchable than the 4-Thread. Therefore it is ideal for seams on knitted fabrics (LN wide) or fine fabrics (RN narrow).

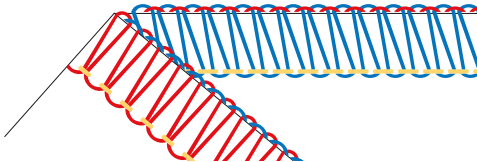

2-Thread Overlock

The 2-thread overlock is formed with an Overlock Needle Thread (LN wide or RN narrow) and the Under Looper Thread. The Lower Looper thread is guided to the right side of the fabric by means of the hooked-in Upper Looper Converter. This overlock stitch is only suitable for edge finishing.

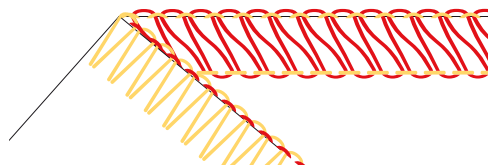

Select stitch by application

Edge serging

The finishing of a fabric edge is mostly used as preparation for open seams or as a decorative edge finish.

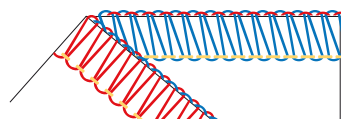
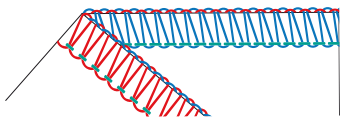
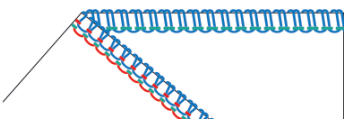
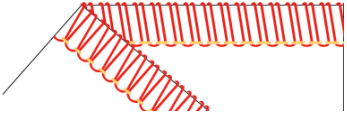
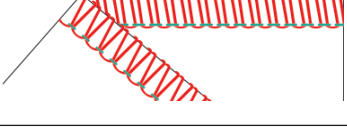
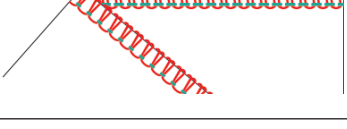
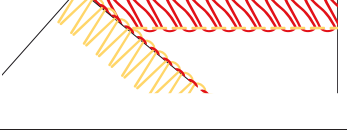
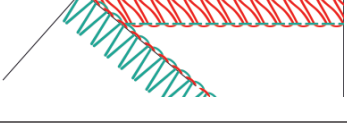
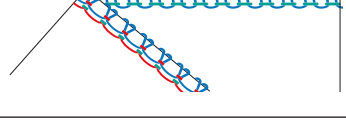
Stitch number	Stitch name	Stitch pattern
No. 3	3-thread overlock wide (LN)	
No. 4	3-thread overlock narrow (RN)	
No. 8	3-thread rolled hem	
No. 9	2-thread wrapped overlock wide (LN)	
No. 10	2-thread wrapped overlock narrow (RN)	
No. 13	2-thread rolled hem	
No. 14	2-thread overlock wide (LN)	
No. 15	2-thread overlock narrow (RN)	
No. 30	3-thread picot stitch	

Seam

Seams are at least two layers of fabric, which are usually placed right side on right side and then sewn together. There are two different types of seams.

- Closed seams
- Flat seams

Closed seam

For closed seams 3-thread or 4-thread overlock stitches are suitable, because they loop around both fabric edges and sew them together. These stitches are mainly chosen for garments made of knitted fabrics and for wide cut garments made of woven fabrics.

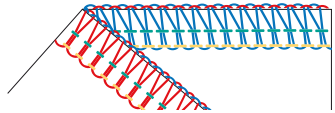
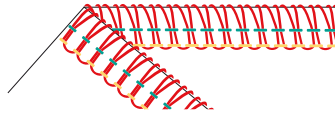
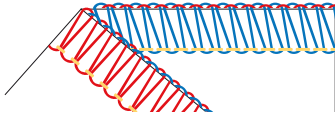
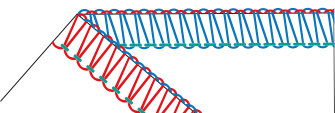
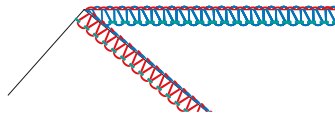
Stitch number	Stitch name	Stitch pattern
No. 1	4-thread overlock with Integrated safety seam	
No. 2	3-thread super-stretch	
No. 3	3-thread overlock wide (LN)	
No. 4	3-thread overlock narrow (RN)	
No. 7	3-thread narrow seam	

Flatlock for flat seams

The flatlock forms loops on the upper side of the seam and stitches on the underside.



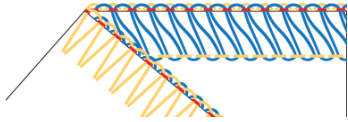
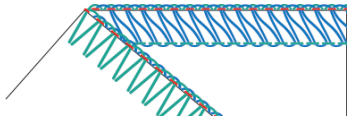
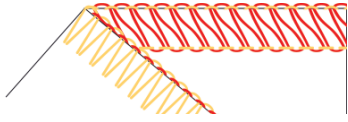
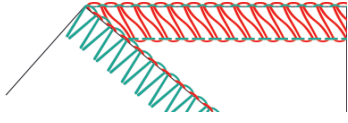













- > Thread and set the machine for 2- or 3-thread flatlock.
- > to sew two layers of fabric together (wrong side on wrong side).
- > Carefully separate the two layers of fabric.
 - The two fabric edges now lie flat on top of each other at the stitch width of the flatlock.

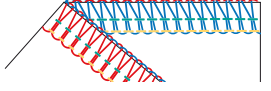
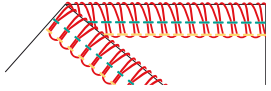

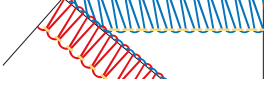
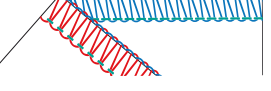
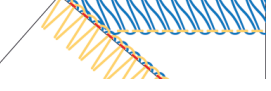
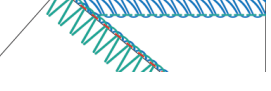
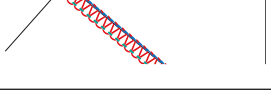
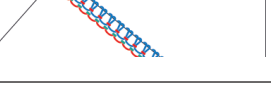
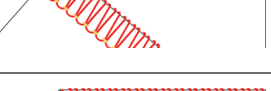

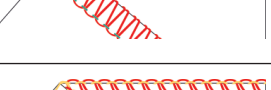

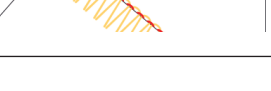







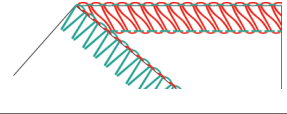

Stitch number	Stitch name	Stitch pattern
No. 5	3-thread flatlock wide (LN)	
No. 6	3-thread flatlock narrow (RN)	
No. 11	2-thread flatlock wide (LN)	
No. 12	2-thread flatlock narrow (RN)	

5.2 Stitch Chart

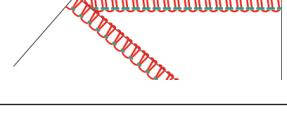
This manual includes a Stitch Overview with all necessary default settings for each stitch. These default values may vary depending on the used material.

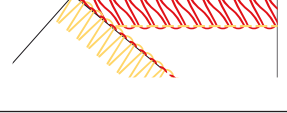
- > Remove all the needles which are not required.
- > Set the mtc Micro Thread Control to «-».

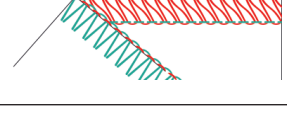
No.	Stitch name	Stitch pattern								
No. 1	4-thread overlock with Integrated safety seam		4	4	4	4	6	N	2.5	1
No. 2	3-thread super-stretch		5	4		4	6	N	2.5	1
No. 3	3-thread overlock wide (LN)		4	—	4	4	6	N	2.5	1
No. 4	3-thread overlock narrow (RN)		—	4.5	4	4	6	N	2.5	1
No. 5	3-thread flatlock wide (LN)		0	—	5	8	5.5	N	2.5	1
No. 6	3-thread flatlock narrow (RN)		—	0	6.5	8	6	N	2.5	1
No. 7	3-thread narrow seam		—	4.5	5	4	6	R	1.5	1
No. 8	3-thread rolled hem		—	4.5	5	7	5	R	1.5	1
No. 9	2-thread wrapped overlock wide (LN)		3	—		3.5	6	N	2.5	1
No. 10	2-thread wrapped overlock narrow (RN)		—	5		4	6	N	2.5	1
No. 11	2-thread flatlock wide (LN)		0,5	—		7	5.5	N	2.5	1

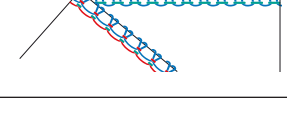
No.	Stitch name	Stitch pattern								
No. 12	2-thread flatlock narrow (RN)		—	3		7.5	6	N	2.5	1
No. 13	2-thread rolled hem		—	5		4.5	5.5	R	1.5	1
No. 14	2-thread overlock wide (LN)		0,5	—		7	5.5	N	2.5	1
No. 15	2-thread overlock narrow (RN)		—	3		7.5	6	N	2.5	1
No. 30	3-thread picot stitch		—	4.5	4	5.5	5.5	R	3	1

6 Machine settings

6.1 Setting the knife

Knife On/Off

For a better overview and better access in the sewing area, e. g. for threading, the knife can be lowered (off) and then engaged again (on). The knife is also lowered if the sewing project already has a clean cut edge and the edge is only to be finished. The best sewing results are achieved by cutting and finishing in one single step.

Knife Off (lowered)

- > Open the Threader Cover.
- > Pull the knife away from the Stitch Plate as far as possible and then lower it forwards to the lock-in position.
 - The knife is lowered.

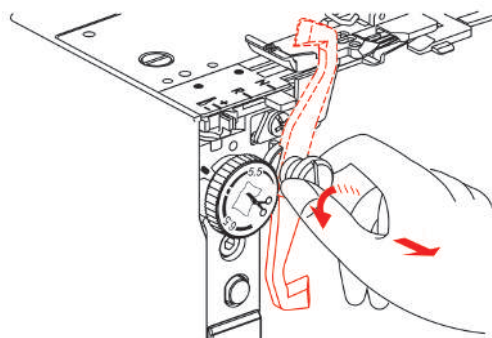

Knife On (engaged)

- > Open the Threader Cover.
- > Pull the knife away from the Stitch Plate as far as possible and then lift it backwards to the lock-in position.
 - The knife is engaged.

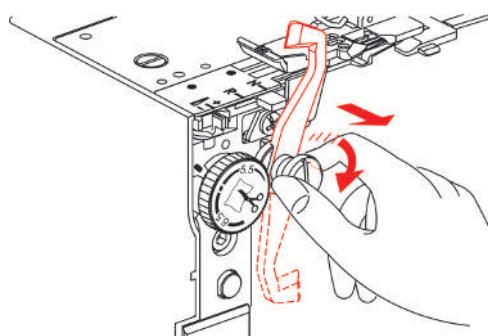

- > Close the Threader Cover.

NOTICE

Finger injury

Before each sewing start make sure that the Knife Cover Insert is attached.

Setting the Cutting Width



The Cutting Width for the knife position can be adjusted between 3 – 7 mm.

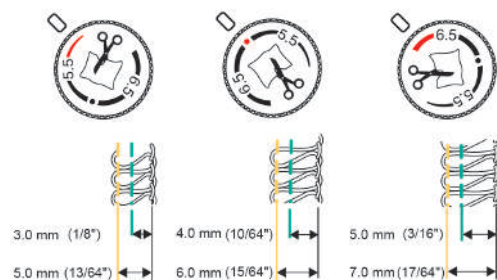

The numbers on the scale correspond with the actual Cutting Width in mm from the Left Overlock Needle «LN» to the cutting edge. The Cutting Width is used to determine the stitch width. The set Cutting Width is indicated at the Cutting Width Dial. (see page 48)

If the Cutting Width changes, the knife, the Stitch Finger and the Threader Cover move in the corresponding direction.

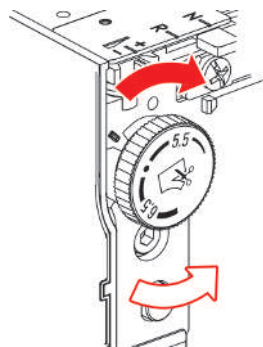

- > To increase the Cutting Width, turn the Cutting Width Dial to the a higher value.
- > To reduce the Cutting Width, turn the Cutting Width Dial to a lower value.

6.2 Upper Looper Converter hooked in/hooked out

By attaching the Upper Looper Converter, the Upper Looper grabs the Lower Looper Thread so that it covers the entire fabric edge.

Prerequisite:

- The needles are in the top position.
 - The Upper Looper Thread is removed.
 - The Lower Looper Thread is below the Upper Looper.
- > To hook in the Upper Looper Cover, place the end of the Upper Looper Cover over the elevation of the Upper Looper and hook the tip of the Upper Looper Cover into the Looper Eye.

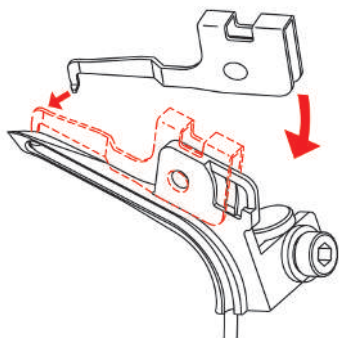

- > To unhook the Upper Looper Cover, lift the end of the Upper Looper Cover upwards and unhook the lock-in lug from the Looper Eye.

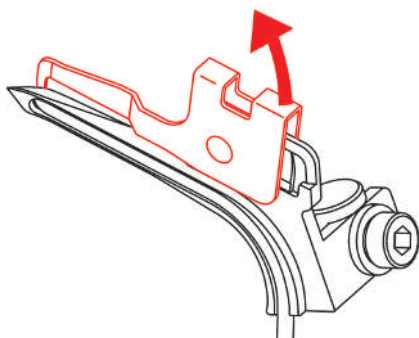

6.3 Rolled Hem Selection Lever «N/R»

Depending on the application, the Rolled Hem Selection Lever must be set to the appropriate position. The adjustment positions for overlocking «N» and rolled hems «R» are marked in the Stitch Plate and can be set there for the desired application.

Overlocking «N»

During overlocking, the Upper and Lower Loper Threads are laid around the Stitch Finger and this creates an even distance to the cut edge. If the thread quantity at the fabric edge is too much or too little, this thread quantity can be corrected by the mtc Micro Thread Control. (see page 47)

- > Move the Rolled Hem Selection Lever to position «N».
 - Overlocking is activated.

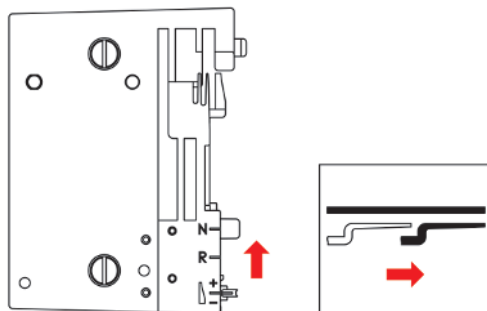

Rolled hem «R»

By retracting the stitch finger, the loops of the upper and lower loopers thread are reduced and the fabric edge is rolled under. Rolled hems are the ideal edge finishing for fine fabrics. These are particularly suitable for decorative finishings on scarves, evening gowns, lingerie, home textiles and as lining seams.

- > Move the rolled hem selection lever to position «R».

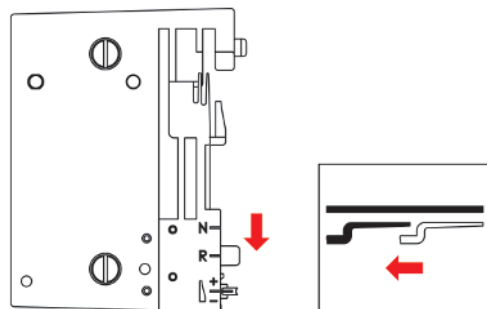

- The rolled hem is activated.
- The stitch finger is retracted.

6.4 Setting the mtc Micro Thread Control

The mtc Micro Thread Control affects the amount of the Loper Thread around the fabric edge and can be adjusted continuously while sewing. This feature makes it easy to achieve a well-balanced stitch at any given Cutting Width.

Prerequisite:

- The Thread Tension is set correctly.
 - The knife position is set correctly.
 - The mtc Micro Thread Control is set to «-».
 - The sewing test has been performed.
- > To enlarge the loops of the Loper Thread at the fabric edge, turn the mtc Micro Thread Control in «+» direction while sewing.

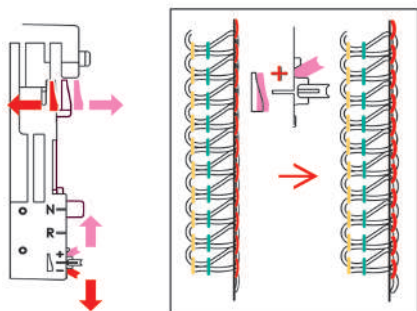

- > To minimize the loops of the Loper Thread at the fabric edge, turn the mtc Micro Thread Control in «-» direction while sewing.

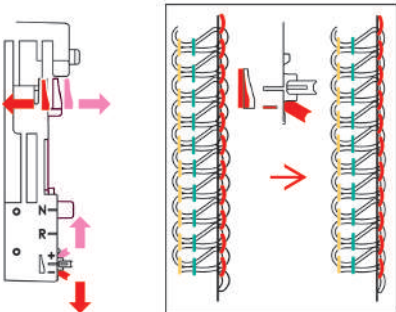

6.5 Setting the Presser Foot Pressure

The Presser Foot Pressure has been set by the factory so that it is optimal to sew medium-weight fabrics. Most materials do not require any adjustment of the Presser Foot Pressure. However, there are some cases where adjustment is necessary, such as when sewing very light or heavy fabrics.

	Extra high
	High
	Medium high
	Default value
	Medium light
	Light
	Extra light

- > Reduce the Presser Foot Pressure for light fabrics.
- > Increase the Presser Foot Pressure for heavy fabrics.
- > Perform a sewing test to set the optimal Presser Foot Pressure for your sewing project.
- > To increase the Presser Foot Pressure, set the Presser Foot Pressure Wheel to a higher value.
- > To reduce the Presser Foot Pressure, set the Presser Foot Pressure Wheel to a lower value.

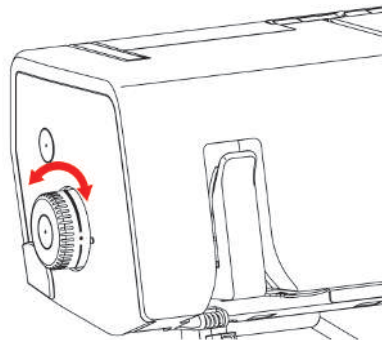

6.6 Adjusting the stitch width

The stitch width can be set in two different ways.

- Needle position
- Cutting Width

Changing the stitch width via the needle position

The stitch width can vary by the choice of needle position by 2 mm.

- > To sew a wide stitch, insert the left needle.
- > To sew a narrow stitch, insert right needle.

Changing the stitch width via the Cutting Width



The stitch width can vary by adjusting the knife position. The scale of the Cutting Width Dial determines the distance between the Left Overlock Needle (LN) and the knife in mm. To the Right Overlock Needle the set scale value is reduced by 2 mm. This means, at a Cutting Width of 6 mm and with the Right Overlock Needle inserted, a 4 mm wide stitch is sewn.

- > To adjust the stitch width, set the Cutting Width Dial between 5 – 7 mm. (see page 44)

6.7 Adjusting the thread tension

The Thread Tension has a considerable influence on each individual thread and its task to perform the stitch formation. The Stitch Chart provides a recommended default value for each stitch. This recommendation can be optimized for different thread/fabric combinations. (see page 62)

- > To reduce the Thread Tension, turn the Thread Tension Adjustment Dial of the corresponding threads down to a lower value.
- > To increase the Thread Tension, turn the Thread Tension Adjustment Dial of the corresponding threads down to a higher value.

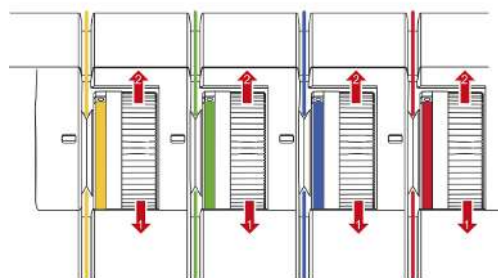

6.8 Adjusting the Differential Feed

 The Differential Feed prevents unwanted puckering or wavering in knitted or stretch fabrics as well as shifting of fabric layers. The setting values describe the ratio of movement of Front Feed Dog relative to the Rear Feed Dog. With default value 1, both Feed Dogs move at the same speed.

- > Adjust the feeding ratio of the two Feed Dogs by using the Differential Feed setting.

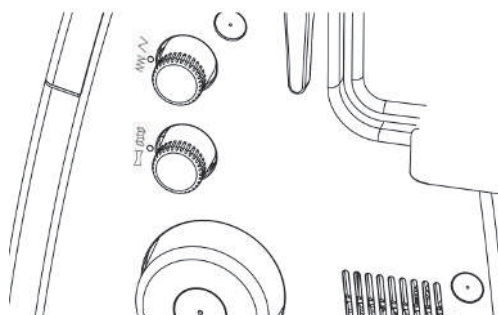

Value	Fabric	Result
2	Fine, soft fabrics	Ruffling, puckering, gathering
1.5	Jersey, sweatshirt, knits	Slight ruffling, preventing seam wavering
1	Woven knit and medium weight dense fabric.	Default value
0.6	Fine nylon tricots, densely woven fabric, lining, satin	Stretching, preventing seam puckering

Default value "1"

In a default value of 1, the machine achieves optimum sewing results with most applications. The Differential Feed in default setting 1 for flat and even seams.

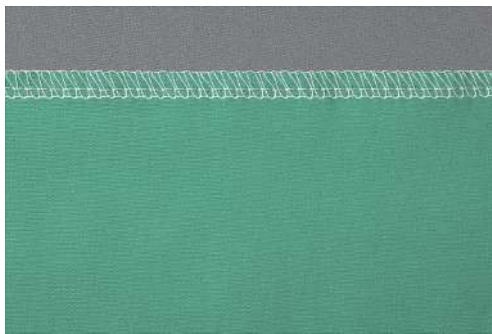
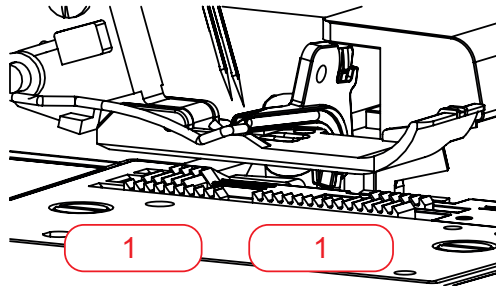

Gathering "1.5 - 2"

At a setting of 1.5 - 2 the Front Feed Dog (2) covers a longer distance than the Rear Feed Dog (1).

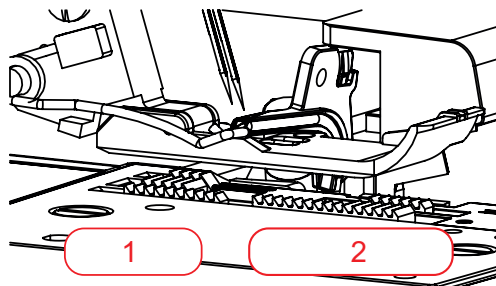

Gathering

> To gather intentionally, increase the Differential Feed to a value between 1.5 and 2. An elongated stitch length enhances the gathering effect.



Gather to fit

- > To prevent waviness increase the Differential Feed to a value between 1 and 2.



Stretching "0.6"

The Front Feed Dog (0.6) covers a shorter distance than the Rear Feed Dog (1). The material is stretched under the presser foot which helps to reduce puckering. This setting can also be used to deliberately stretch the material.

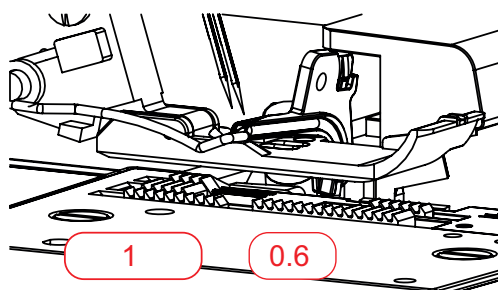

- > To prevent seam puckering, reduce the Differential Feed to a value between 0.6 and 1.



7 Threading

This machine is equipped with an Air Threader System, which quickly and easily threads the Upper and the Lower Loper Threads by pressing the threader button. There is no specific sequence required for threading the Loper Threads.

The Needle Threads must be threaded according to a defined threading sequence.

- > Thread the right Overlock Needle Thread before the left Overlock Needle Thread.

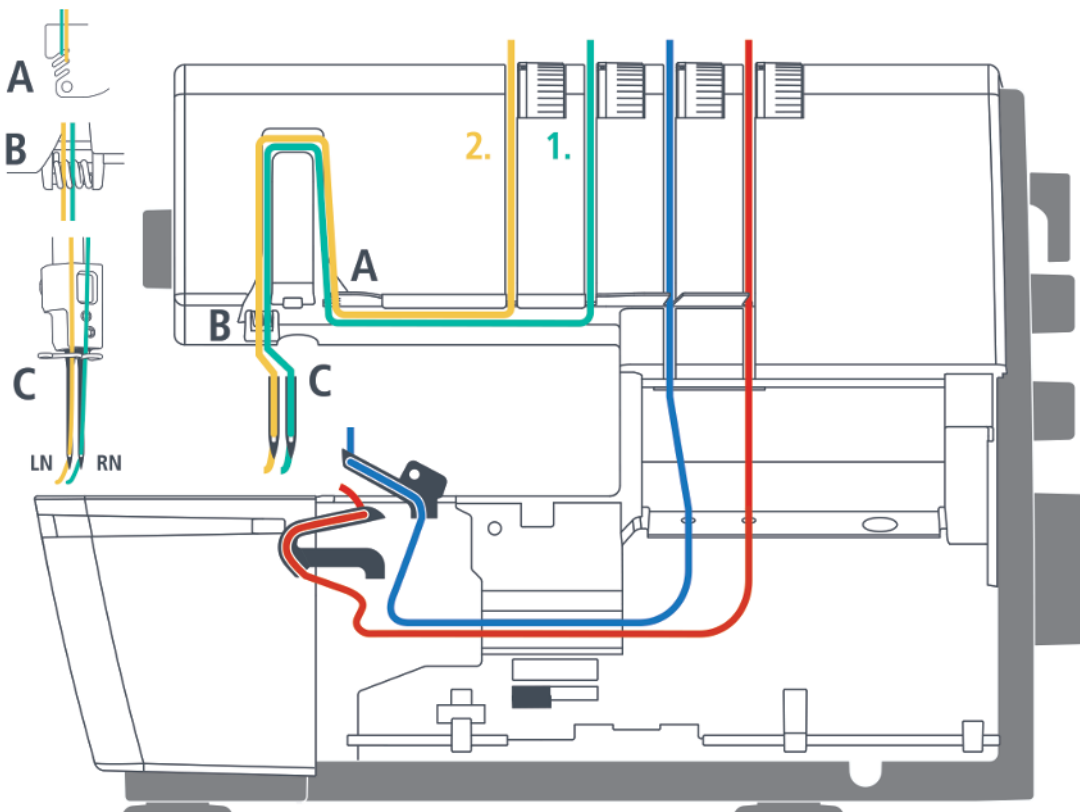

7.1 Threading preparation

Before threading, make sure that the device is mechanically adjusted to the required stitch. Perform the required mechanical settings e.g. for needle, Rolled Hem Selection Lever or Upper Loper Cover.

Prerequisite:

- Retractable Thread Guide fully extended.
 - The needles are at the top position.
 - All threads that are not needed for the particular stitch have been removed.
- > Raise the presser foot.
 - The Thread Tensions are released and the thread can be inserted without resistance.

- > Place the thread cones on the respective spool pin.
- > Place the thread from the back through the Thread Guide.

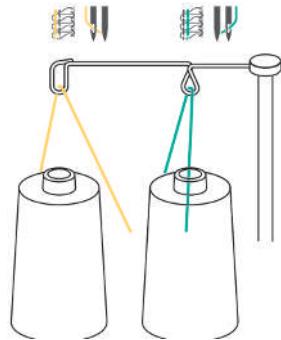

- > Engage the thread in the Thread Pretension.

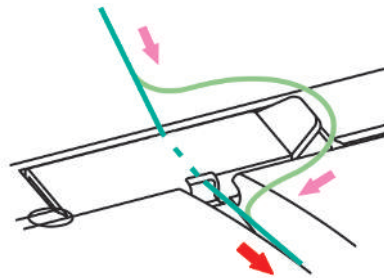

- > Place the thread along the Threading Path between the Thread Tension Discs.

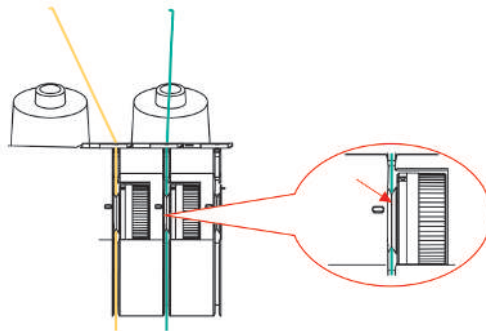

7.2 Air Threader

The Lower Loper Thread (red) is needed for each stitch. Depending on the stitch, the Upper Loper Thread (blue) must be additionally threaded. If the upper looper thread is not used, the upper looper thread cover must be attached.

NOTICE

Damage by coated or waxed threads

Coated or waxed threads may lose some of their coating in the Air Threader Pipes, which results in permanent blocking of the pipes. A repair by the Authorized bernette dealer is required. Avoid the use of coated or waxed threads.

- > Threading the Loper Threads

Detailed information can be found in the stitch chart.

Threading the Looper Threads UL/blue, LL/red

Due to the Air Threader all of the Looper Threads can be threaded in one step.

Prerequisite:

- (see page 53)
 - Threader Cover is opened.
 - Upper Looper Cover hooked in/hooked out is checked.
- > Set the Air Threader Connector to the left position.

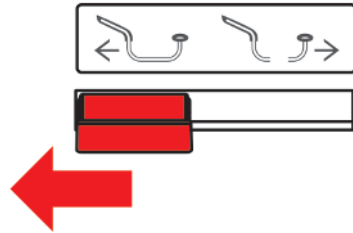

- > Slowly turn the Handwheel counterclockwise until the Air Threader Pipes couple.

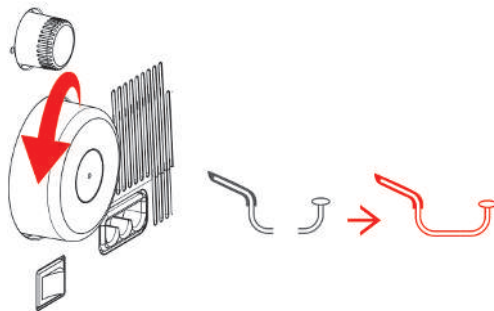

- > Feed the thread through the Thread Guide.

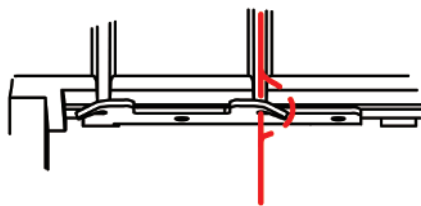

- > Pull a thread reserve of approx. 56 cm so that the thread can be completely drawn through the Air Threader Pipe.

- > Place the end of the thread approx. 1.2 cm into the corresponding Air Threader Nozzle.

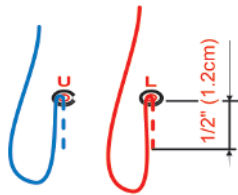

- > Press and hold the Air Threader Button.

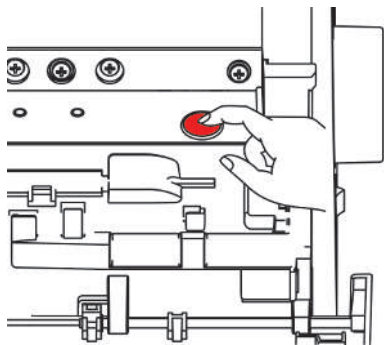

- The automatic thread feed into the Air Threader starts.
 - The Looter Thread is shot through the Air Threader Pipe and exits at the Looter Tip.
- > As soon as the Looter Thread exits out of the Looter Eye, release the Air Threader Button.

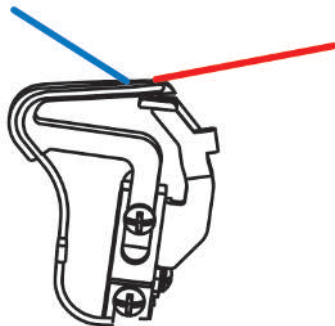

- > Place the Looter Thread under the presser foot to the back left.
- > Repeat the process with the other Looter Thread if required.
- > Set the Air Threader Connector to the right position.

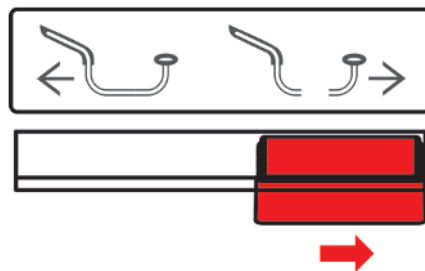

- > Close the Threader Cover.

Threading the Looper Thread with an auxiliary thread

The use of an auxiliary thread makes sense if a Looper Thread cannot be threaded automatically with the Air Threader.

Prerequisite:

- (see page 53)
- > Open the Threader Cover.
- > Set the Air Threader Connector to the «left position».
- > Prepare an auxiliary thread at a length of about 60 cm.
- > Fold the auxiliary thread in half, hold the thread end with the loop in your hand and position the two thread ends above the respective Air Threader Nozzle.
- > Start the Air Threader Process until the thread ends of the auxiliary thread emerge out of the Looper Eye.
- > Place the Looper Thread end at the length of about 20 cm through the loop of the auxiliary thread.
- > Pull the auxiliary thread ends until the thread comes out of the Looper Eye.
- > Remove the auxiliary thread.
- > Place the Looper Thread under the presser foot to the back left.

Using the Threading Wire

The supplied Threading Wire can be used as a threading aid for the Looper Thread. The Threading Wire is a wear part and not designed as a permanent threading or cleaning aid.

NOTICE

Damage by improper use of the Threading Wire

The Air Threader Pipes may be damaged. A repair by the Authorized bernette dealer is required.

- > Insert and pull through the Threading Wire only in the thread flow direction.

Prerequisite:

- There is no thread in the respective Air Threader Pipe.
- «Threading preparation» (see page 53)
- > Open the Threader Cover.
- > Guide the Threading wire with the end without loop through the corresponding Air Threader Nozzle until it exits at the Looper Eye.
- > Place the wanted thread through the loop of the Threading Wire.

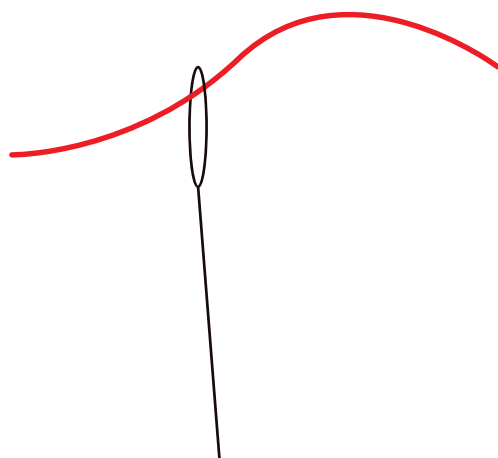

- > Pull the end of the Threading Wire until the Looper Thread exits from the Looper Eye.
- > Place the Looper Thread under the presser foot to the back left.
- > Close the Threader Cover.

Any malfunctions of the Air Threader System must be repaired by an Authorized BERNINA dealer.

7.3 Threading the needle thread

For the needles inserted in the needle holder, color-coded threading paths are assigned.

Threading the Right Needle Thread RN/green

- ▶ The Right Needle Thread Path is marked green.

Prerequisite:

- (see page 53)
- > Pull the thread beneath the Thread Guide Plate to the left and up between the backmost opening of the Thread Deflection Finger.

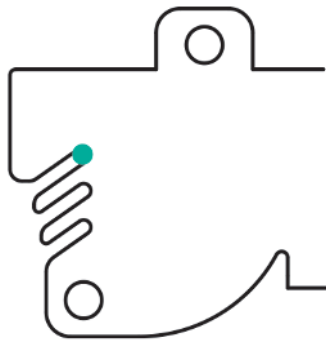

- > Place the thread over the Needle Thread Take-up Lever Cover and pull it down.

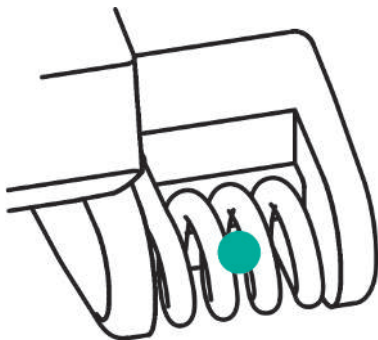

- > Insert the thread into the right Thread Guide.
- > Hook the thread into the right Thread Guide at the Needle Holder.

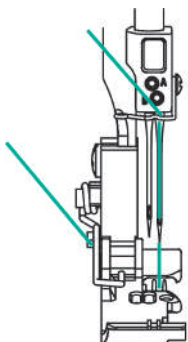

- > Thread the Right Overlock Needle (RN).
- > Place the thread beneath the presser foot to the back left.

Threading the Left Needle Thread LN/yellow

- ▶ The Left Needle Thread Path is marked yellow.

Prerequisite:

- The Right Needle Thread is threaded.
 - The «Threading preparation» has been performed. (see page 53)
- > Pull the thread beneath the Thread Guide Plate to the left and up through the center opening of the Thread Deflection Finger.

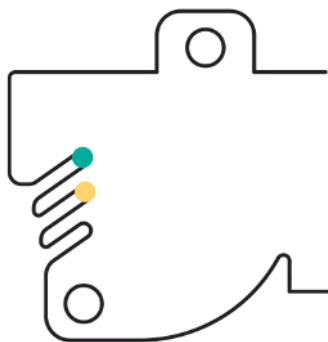

- > Place the thread over the Needle Thread Take-up Lever Cover and pull it down.

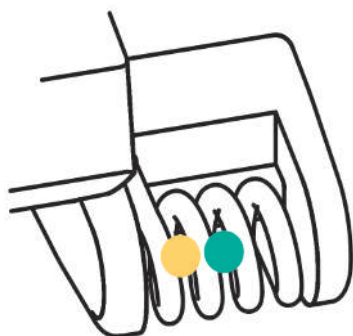

- > Insert the thread into the left Thread Guide.
 > Hook the thread into the left Thread Guide at the Needle Holder.

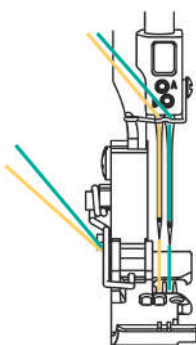

- > Thread the Left Overlock Needle (LN).
 > Place the thread beneath the presser foot to the back left.

7.4 Thread change

Knitting thick thread

Tying on threads is often used for changing needle thread or Loper threads. (see page 61)

Keep the knotted area as little as possible to reduce friction.

NOTICE

Pulling a thread tie through the needle eye

The needle can be bent. A bent needle affects the stitch formation.

> Cut the tie in front of the needle eye and thread the needle individually.

> Form a loop with the dark thread.

> Thread the pink thread end from beneath into the dark thread loop.

> Guide the pink thread to the back around the two dark threads and from above through the loop.

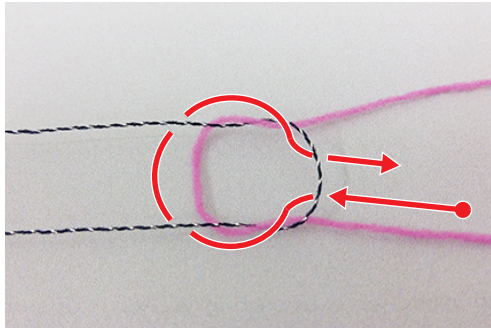

> Hold both thread ends and pull them apart.

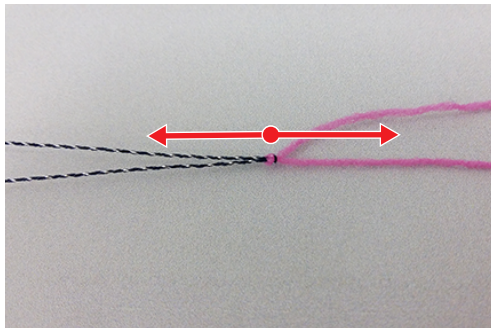

Changing the needle thread

NOTICE

Pulling a thread tie through the needle eye

The needle can be bent. A bent needle affects the stitch formation.

- > Cut the tie in front of the needle eye and thread the needle individually.
- > Cut the thread above the thread cone.
- > Change the thread cone.
- > Tie the threaded thread to the new thread.

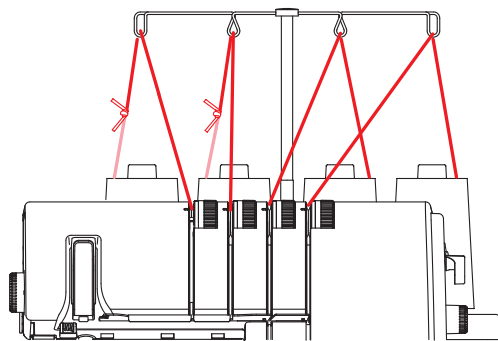

- > Pull the threaded end of the thread until the newly knotted thread is in front of the needle eye.
- > Cut off the new thread behind the knotting.

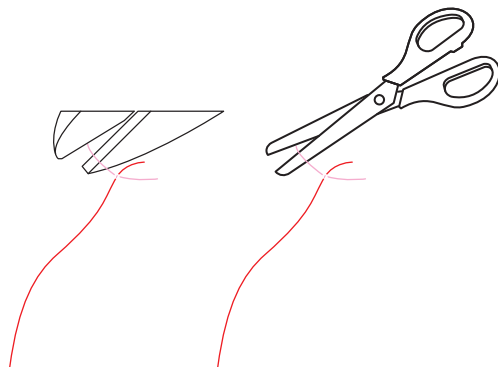

- > Remove the excess thread from the eye of the needle.
- > Thread the needle eye.
- > Place the thread beneath the presser foot to the back left.

Changing the looper thread

- > Cut the thread above the thread cone.
- > Change the thread cone.
- > Tie the inserted Looper Thread to the new thread.

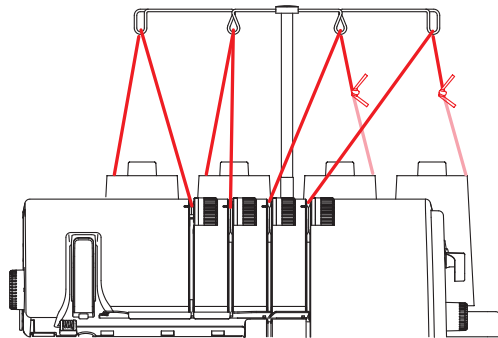

- > Pull the end of the thread out of the Looper Eye until the knot emerges.
- > Cut off the new thread behind the knotting.
- > Place the thread under the presser foot to the left.

8 Sewing test

To check the optimal setting, a sewing test should be sewn on a spare piece of the fabric used for your project.

The default values of the stitches represent recommendations that work for most standard applications. Depending on the sewing test, fine adjustments for stitch optimization are possible.

8.1 Performing a sewing test for an overlock stitch

Prerequisite:

- (see page 33)
- > Place the fabric under the presser foot to the front of the knife so that the desired seam allowance is cut off.
- > Press the Foot Control and sew slowly. Guide the fabric gently as the machine automatically transports the material.
- > Sew beyond the fabric end such that a thread chain is formed.
- > Pull the thread chain over the Thread Cutter.
- > Assess the sewing test and make any necessary adjustments until the stitch setting matches the material combination.

8.2 Optimizing stitches

Optimizations of stitches should be made systematically. In the following, recommendations are listed for each stitch type, which optimize the stitch pattern through specific changes to the machine setting.

- > Perform one action step after another, starting from the top.
- > Reduce the Thread Tension in the first place before increasing the Thread Tension.
- > Alter the Thread Tensions only by half or one digit at a time.
- > Perform a sewing test.

4-/3-thread Overlock

With a balanced stitch formation, the Loper Thread (blue/red) are intertwined at the fabric edge.

The Needle Threads (green/yellow) create two straight lines of stitches on the right side of the stitch and appear as dots on the wrong side of the stitch.

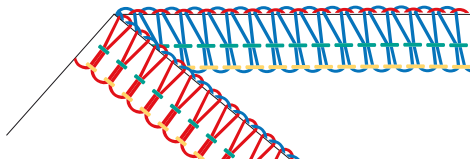

Stitch pattern	Solution
The Loper Threads are intertwined on the wrong side of the fabric.	<ul style="list-style-type: none"> > Reduce the Lower Loper Thread Tension (red). > Increase the Upper Loper Thread Tension (blue).
The Loper Threads are intertwined on the right side of the fabric.	<ul style="list-style-type: none"> > Reduce the Upper Thread Tension (blue). > Increase the Lower Loper Thread Tension (red).
The Left Needle Thread forms loops on the wrong side of the fabric.	<ul style="list-style-type: none"> > Increase the Left Needle Thread Tension (yellow). > Reduce the Lower Loper Thread Tension (red).
The Right Needle Thread forms loop on the wrong side of the fabric.	<ul style="list-style-type: none"> > Increase the Right Needle Thread Tension (green).
The fabric edge curls.	<ul style="list-style-type: none"> > Reduce the Upper Thread Tension (blue). > Reduce the Lower Loper Thread Tension (red). > Increase the mtc Micro Thread Control. > Reduce the Cutting Width «CW». > Check the Rolled Hem Selection Lever position «N».
The seam puckers.	<ul style="list-style-type: none"> > Reduce the Left Needle Thread Tension (yellow). > Increase the Right Needle Thread Tension (green). > Set the Differential Feed between 1 and 0.6 (Stretching). > Shorten the Stitch Length «SL».

Tab. 1: Optimizing the stitch: 4-/3-thread overlock

3-Thread Narrow Seam

With a balanced stitch formation, the looper thread (blue/red) are intertwined at the fabric edge.

The needle thread (green) is identifiable on the top side of the stitch as a straight line and on the bottom side of the stitch as points.

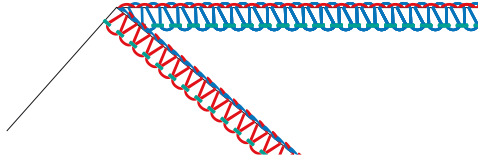

Stitch pattern	Recommendation
The looper threads are intertwined on the wrong side of the fabric.	<ul style="list-style-type: none"> > Reduce the lower looper thread tension (red). > Increase the upper looper thread tension (blue).
The looper threads are intertwined on the right side of the fabric.	<ul style="list-style-type: none"> > Reduce the upper thread tension (blue). > Increase the lower looper thread tension (red).
The right needle thread forms loop on the wrong side of the fabric.	<ul style="list-style-type: none"> > Increase the right needle thread tension (green).
The fabric edge doesn't curl as intended.	<ul style="list-style-type: none"> > Increase the upper looper thread tension (blue). > Increase the lower looper thread tension (red). > Increase the cutting width «CW». > Shorten the stitch length «SL». > Check the rollhem selector lever position «R».

Tab. 2: Optimizing the stitch: 3-Thread Narrow Seam

3-thread super-stretch / 2-thread wrapped overlock

With a balanced stitch formation, the Loper Thread (red) loops around the cutting edge.

The Needle Threads (green/yellow) create two straight lines of stitches on the right side of the stitch and appear as dots on the wrong side of the stitch.



The elasticity of the 3-thread super-stretch can be increased by shortening the stitch length or by reducing the Needle Thread Tension depending on the material and application.

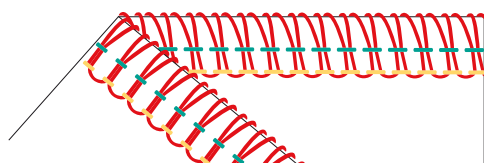

Stitch pattern	Solution
The Loper Thread is too loose around the fabric edge.	<ul style="list-style-type: none"> > Increase the Lower Loper Thread Tension (red). > Increase the mtc Micro Thread Control.
The Loper Thread is too tight around the fabric edge.	<ul style="list-style-type: none"> > Reduce the Lower Loper Thread Tension (red). > Increase the mtc Micro Thread Control. > Reduce the Cutting Width «CW». > Check the Rolled Hem Selection Lever position «N».
The Needle Thread forms loops on the wrong side of the fabric.	<ul style="list-style-type: none"> > Increase the Needle Thread Tension (yellow, green). > Reduce the Lower Loper Thread Tension (red).
The fabric edge forms a tunnel or curls.	<ul style="list-style-type: none"> > Reduce the Lower Loper Thread Tension (red). > Increase the mtc Micro Thread Control. > Reduce the Cutting Width «CW». > Check the Rolled Hem Selection Lever position «N».
The seam puckers.	<ul style="list-style-type: none"> > Reduce the Left Needle Thread Tension (yellow). > Increase the Right Needle Thread Tension (green). > Set the Differential Feed between 1 and 0.6 (Stretching). > Shorten the Stitch Length «SL».

Tab. 3: Optimizing the stitch: 3-thread super-stretch / 2-thread wrapped overlock

3-thread flatlock

With a balanced stitch formation, the upper thread (blue) is on the right side of the stitch related to the insertion into the fabric edge.

The Lower Loper Thread (red) is parallel to the fabric edge.

The Needle Thread (yellow or green) forms a «V» on the wrong side of the stitch related to the insertion into the fabric edge.

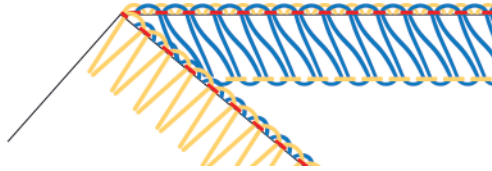

Stitch pattern	Solution
The Lower Loper Thread overedges the fabric edge towards the wrong side of the fabric.	<ul style="list-style-type: none"> > Reduce the Needle Thread Tension (yellow or green). > Increase the Upper Loper Thread Tension (blue).
The Upper Loper thread doesn't reach to the fabric edge.	<ul style="list-style-type: none"> > Increase the Needle Thread Tension (yellow or green). > Reduce the Upper Loper Thread Tension (blue).
The Lower Loper thread is not parallel to the fabric edge.	<ul style="list-style-type: none"> > Increase the Lower Loper Thread Tension (red). > Reduce the Needle Thread Tension (yellow or green). > Reduce the Upper Loper Thread Tension (blue).
The seam puckers, the Lower Loper Thread is overstretched.	<ul style="list-style-type: none"> > Reduce the Lower Loper Thread Tension (red).
The Needle Thread doesn't reach to the fabric edge.	<ul style="list-style-type: none"> > Reduce the Needle Thread Tension (yellow or green). > Increase the Upper Loper Thread Tension (blue).
The Lower Loper Thread overedges the fabric edge towards the wrong side of the fabric.	<ul style="list-style-type: none"> > Increase the Needle Thread Tension (yellow or green). > Reduce the Upper Loper Thread Tension (blue).
The fabric edge curls.	<ul style="list-style-type: none"> > Reduce the Needle Thread Tension (yellow or green). > Reduce the Upper Loper Thread Tension (blue). > Increase the mtc Micro Thread Control. > Reduce the Cutting Width «CW». > Check the Rolled Hem Selection Lever position «N».

Tab. 4: Optimizing the stitch: 3-thread flatlock

3-thread rolled hem / 3-thread picot stitch

With a balanced stitch formation, the upper looper thread (blue) loops around the cutting edge.

The Lower Loper thread (red) lies straight along the needle thread on the wrong side of the stitch.

The Needle Thread (green) is identifiable on the right side of the stitch as a straight line and on the wrong side of the stitch as points.

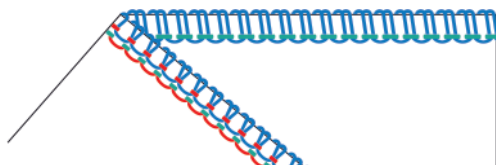

Stitch pattern	Solution
The Loper Thread is too loose around the fabric edge.	<ul style="list-style-type: none"> > Increase the Upper Loper Thread Tension (blue). > Increase the Cutting Width «CW». > Shorten the Stitch Length «SL».
The fabric edge doesn't curl as intended.	<ul style="list-style-type: none"> > Increase the Cutting Width «CW». > Increase the Upper Loper Thread Tension (blue). > Elongate the Stitch Length «SL».
The Upper Loper Thread is too tight around the fabric edge.	<ul style="list-style-type: none"> > Reduce the Upper Loper Thread Tension (blue). > Shorten the Stitch Length «SL».
The Lower Loper Threads are not parallel to the needle thread.	<ul style="list-style-type: none"> > Increase the Lower Loper Thread Tension (red). > Increase the Right Needle Thread Tension (green).
The seam puckers, the Lower Loper Thread is overstretched.	<ul style="list-style-type: none"> > Reduce the Lower Loper Thread Tension (red).
The needle thread forms loops on the wrong side of the fabric.	<ul style="list-style-type: none"> > Increase the Right Needle Thread Tension (green).
The seam puckers.	<ul style="list-style-type: none"> > Reduce the Lower Loper Thread Tension (red). > Set the Differential Feed between 1 and 0.6 (Stretching). > Increase the Right Needle Thread Tension (green). > Shorten the Stitch Length «SL».

Tab. 5: Optimizing the stitch: 3-thread rolled hem / 3-thread picot stitch

2-thread rolled hem

With a balanced stitch formation, the looper thread (red) loops around the cutting edge. The Needle Thread (green) is identifiable on the right side of the stitch as a straight line and on the wrong side of the stitch as points.

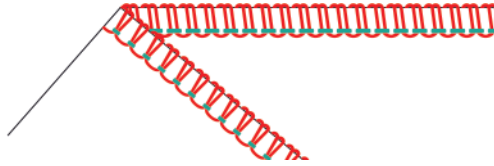

Stitch pattern	Solution
The Looper Thread is too loose around the fabric edge.	> Increase the Lower Looper Thread Tension (red).
The Looper Thread is too tight around the fabric edge.	> Reduce the Lower Looper Thread Tension (red). > Reduce the Cutting Width «CW».
The fabric edge doesn't curl as intended.	> Increase the Cutting Width «CW». > Elongate the Stitch Length «SL». > Increase the Lower Looper Thread Tension (red).
The Needle Thread forms loops on the wrong side of the fabric.	> Increase the Right Needle Thread Tension (green).
The seam puckers.	> Reduce the Right Needle Thread Tension (green). > Set the Differential Feed between 1 and 0.6 (Stretching). > Shorten the Stitch Length «SL».

Tab. 6: Optimizing the stitch: 2-thread rolled hem

2-thread flatlock / 2-thread overlock

With a balanced stitch formation, the Lower Looper Thread (red) lies on the right side of the stitch from the needle penetration point to the fabric edge.

The Needle Thread (yellow or green) forms a «V» on the wrong side of the stitch related to the insertion into the fabric edge.

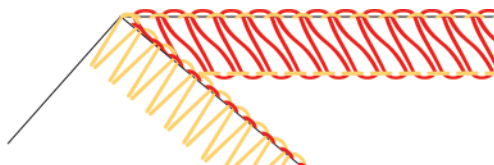

Stitch pattern	Solution
The Lower Looper Thread overedges the fabric edge towards the wrong side of the fabric.	<ul style="list-style-type: none"> > Increase the Lower Looper Thread Tension (red). > Reduce the Needle Thread Tension (yellow or green).
The lower looper thread doesn't reach to the fabric edge.	<ul style="list-style-type: none"> > Reduce the Lower Looper Thread Tension (red). > Increase the Needle Thread Tension (yellow or green).
The Needle Thread doesn't reach to the fabric edge.	<ul style="list-style-type: none"> > Increase the Lower Looper Thread Tension (red). > Reduce the Needle Thread Tension (yellow or green).
The Lower Looper Thread overedges the fabric edge towards the wrong side of the fabric.	<ul style="list-style-type: none"> > Reduce the Lower Looper Thread Tension (red). > Increase the Needle Thread Tension (yellow or green).
The fabric edge forms a tunnel or curls.	<ul style="list-style-type: none"> > Increase the mtc Micro Thread Control. > Reduce the Cutting Width «CW». > Shorten the Stitch Length «SL». > Check the Rolled Hem Selection Lever position «N».

Tab. 7: Optimizing the stitch: 2-thread flatlock / 2-thread overlock

9 Practical overlocking

In this chapter the most important applications for a successful sewing project are described. More advanced sewing techniques are described in the BERNINA Overlocker Manual and can be purchased from Authorized BERNINA dealers.

9.1 Securing overlock stitches

The stitches are secured when they are overstepped.

Securing stitches is particularly important when seam ends are not secured by other seams or hems.

Sewing in the overlock chain at the start of the seam

- > Form a thread chain at a length of 5 - 8 cm.
- > Place the fabric under the presser foot and sew a stitch into the fabric.
- > Lower the needle .
- > Raise the presser foot.
- > Now pull the thread chain carefully forward and place it on the seam line to be sewn.
- > Lower the presser foot.
- > Sew approx. 4 cm over the thread chain.



Sewing in the overlock chain at the end of the seam

- > At the end of the seam, sew one stitch over the fabric edge.
- > Raise the needle.
- > Raise the presser foot.
- > Pull the fabric a bit backwards.
- > Turn the fabric so that the wrong side points upwards.
- > Place the fabric beneath the presser foot so that the needles pierce the fabric at the first stitch.
- > Lower the presser foot.
- > Sew approx. 1.5 - 2.5 cm over the thread chain and make sure that the existing thread chain is not cut.
- > Finish the seam by sewing off the edge.



Securing overlock stitches

- > Sew a thread chain of about 10 cm beyond the end of the seam.
- > Pull the thread chain end through the looper threads using a loop flip or a tapestry needle.



Knotting the overlock chain

Knotting the overlock chain is the safest way to prevent the stitch from opening.

- > Tie thread chain at the seam end, close to the fabric.

9.2 Undoing overlock stitches

The thread loops of the Looper and Needle Threads can be undone easily.

- > Pull the right overlock Needle Thread (RN) out of the thread chain with tweezers, starting from the seam end.



- > Pull the Needle Thread out of the seam.

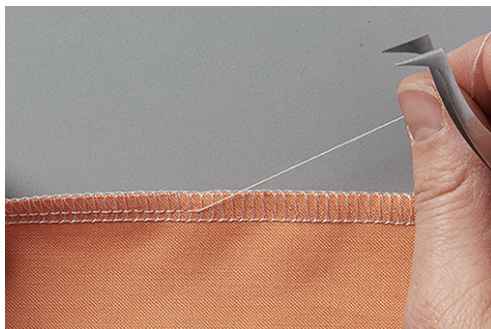

- > With very long seams, cut the thread in the stitch and remove it step by step.
- > Remove the left overlock Needle Thread in the same way.
 - The looper threads lie loosely around the fabric edge and can be pulled away easily.



9.3 Flatlock

The flatlock forms loops on the upper side of the seam and stretch stitches on the underside.

- > Set the machine for a 2- or 3-thread flatlock.
- > Sew two layers of fabric together (wrong side on wrong side).
- > Carefully separate the two layers of fabric.
 - The two fabric edges now lie flat on top of each other at the stitch width of the flatlock.

Flatlock narrow

A narrow flatlock is the result when the right Overlock Needle (RN) is inserted.

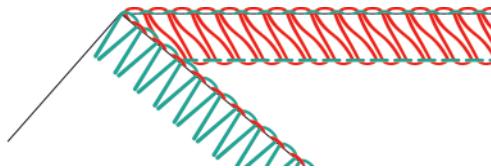

Flatlock wide

A wide flatlock is the result when the left Overlock Needle (LN) is inserted.

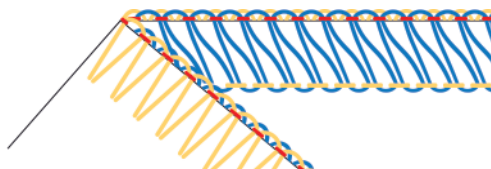

9.4 Gathering

Ruffling is a gathering or puckering of a seam.

Increasing the differential feed

- > Set the machine for a 4-thread overlock.
- > Set the Differential Feed to «2».
- > Set the stitch length to «4.5».
- > Sew the fabric with this side up on which the ruffling is wanted.
- > Sew off the edge of the fabric.

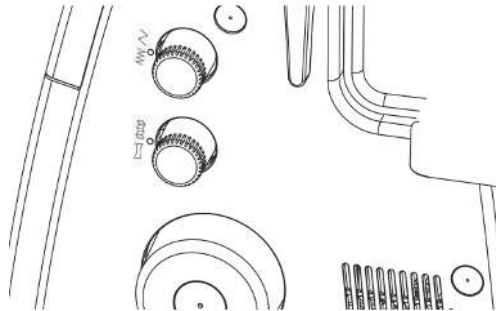

Pulling the needle thread

- > Set the machine for a 4-Thread Overlock.
- > Set the differential feed at default value.
- > Sew the fabric with this side up on which the ruffling is wanted.
- > Leave a long thread chain at seam end.
- > Separate the needle thread/threads from the thread chain.
- > Pull the needle thread(s) and evenly spread the puckers along the seam.



9.5 Sew outer corners

A neat corner can be achieved by the following two methods.

Method 1

- > Set the machine for a 2-, 3- or 4-thread overlock.
- > Sew along the edge of the fabric beyond the corner.
- > Start a new edge and sew over the previously sewn edge.
- > Secure the thread chain. (see page 71)



Method 2

- > Trim the seam allowance for the Cutting Width of the following corner in the sewing direction (presser foot length).

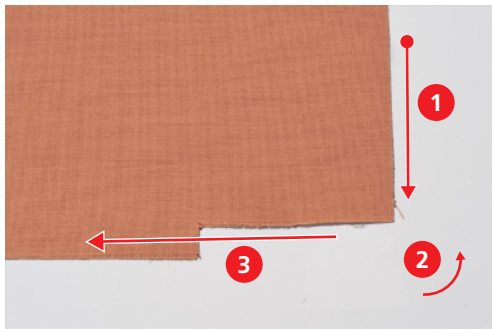

- > First sew the edge up to the cut corner.
- > Sew one stitch beyond the fabric edge and stop.
 - The needles are in the top position.
- > Raise the presser foot.
- > Move the Rolled Hem Selection Lever to position «R».
 - The thread loops are loosened from the Stitch Finger.
- > Turn the fabric counterclockwise.
 - The trimmed edge of the fabric is in the sewing direction under the presser foot.
- > Switch the Rolled Hem Selection Lever to «O».
- > Pierce the needle into the fabric.
- > Pull back and tighten loose threads of the thread spools on the Thread Stand.

- > Lower the presser foot and continue sewing.



9.6 Sewing inner corners

- > Set the machine for a 2- or 3-thread overlock.



- > Draw sewing lines on both sides of the corner about 5 cm long with the fabric pen.
- > Sew the seam until the knife reaches the corner.
- > Place the needle in the fabric.
- > Raise the presser foot.
- > Carefully pull the fabric edge to a straight line and fold the fabric forwards.
- > Lower the presser foot.
- > Continue sewing until the needles reach the corner.
- > Place the needles exactly in the inner corner to fix the fabric.
- > Raise the presser foot and fold the fabric to the back.
- > Lower the presser foot and continue sewing.

9.7 Sewing inner curves

Inner curves appear on necklines, facings and armholes. Time-consuming clipping or trimming can be avoided by overlocking the fabric edge.

- > Set the machine for a 3- or 4-Thread Overlock.
- > While sewing, stretch the curve carefully so it is straight.



9.8 Sew outer curves and circles

Due to the Differential Feed, the seam can be pulled or pushed into shape for flat, round edges.

- > Cut away the seam allowance in one place along the length of the presser foot.



- > Start and end the seam at the cut seam allowance.
 - if seam waving out happens: set the Differential Feed to 1.5 – 2.
 - if puckering happens: set the Differential Feed to 0.7 – 1.
- > At the seam end, sew 1 – 2 stitches over the seam beginning.
- > Lower the needle and raise the presser foot.
- > Turn the fabric off to the left of the presser foot.

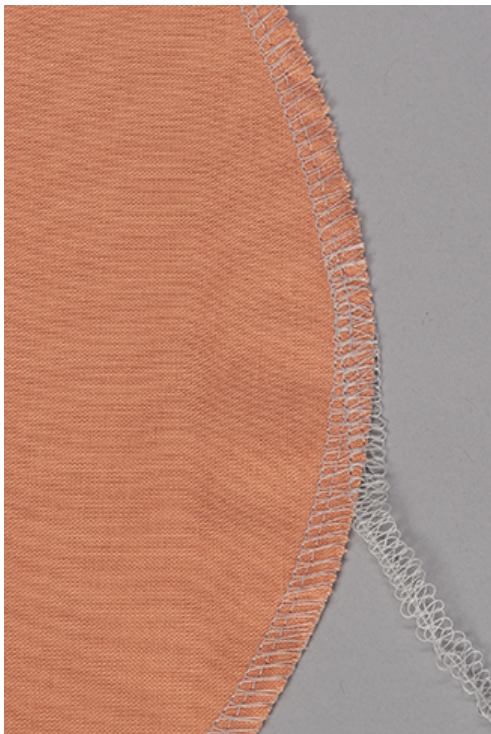

- > Lower the presser foot and sew over and beyond the fabric.

10 Appendix

10.1 Storing and transporting the machine

Storing the machine

The correct storage of the machine over a longer period of time has an influence on its lifespan and functionality.

- > Don't store the machine outdoors.
- > Protect the machine against climatic influences.
- > Before operating the machine again after storage, leave the machine unpacked for approx. 1 h at room temperature.

Transporting the machine

For a relocation or a longer transport of the machine, the following actions should be carried out.

- > Retract the Retractable Thread Guide of the Thread Stand completely downwards.
- > Lower the presser foot.
- > Remove all connecting cables.
- > Lift and transport the machine at the carry handle.

10.2 Maintenance and cleaning the machine

NOTICE

Damage by cleaning with compressed air

Cleaning using aerosol sprays or compressed air may cause permanent damage to your machine. A repair by the Authorized bernette dealer is required.

- > Remove fabric scraps and thread remnants using a vacuum cleaner with soft tip.

Cleaning the machine

The service life of the machine depends on the care and maintenance. Based on normal household use, an annual service at the Authorized bernette dealer is recommended.

Recommended aids for cleaning:

- Damp cloth
- Brush
- Tweezers
- Vacuum cleaner with soft tip
- > The machine can be cleaned with a damp cloth without detergent.
- > Free the sewing area from fabric and thread scraps regularly after sewing.
 - Needle, Needle Bar
 - Presser Foot
 - Feed Dog (from above)
 - Knife
 - Freearm interior

Cleaning the Looper Area

Dust, fabric and thread remnants accumulate in the looper area during overlocking and these should be removed regularly.

Prerequisite:

- The presser foot is raised.
 - The needles are in the top position.
 - Switch the machine off.
- > Remove the presser foot.
 - > Lower the knife.
 - > Remove the Stitch Plate from the freearm by loosening the screws.

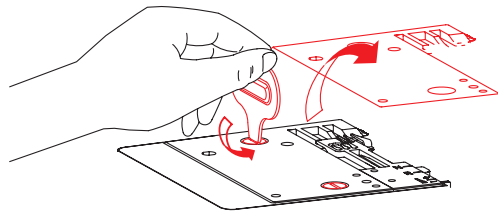

- > Remove dust, fabric and thread remnants with the brush or a vacuum cleaner.

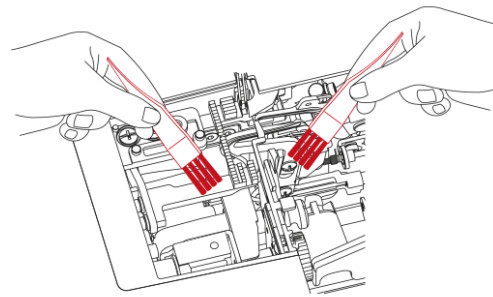

- > Attach the Stitch Plate and screw it on.
- > Activate the knife.
- > By slowly turning the Handwheel, ensure that the knife, the Needle and the Feed Dogs are not impeded in their movement.

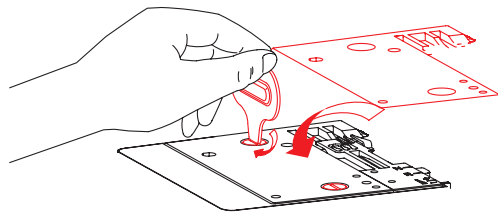

- > Attach the presser foot.

Cleaning the air threader pipes

Regularly remove dust and thread remnants from the air threader pipes.

Prerequisite:

- Use a thick thread (e.g. Amann Saba C size 30) at a length of about 1 m.
- > Thread the thread into the Air Threader Nozzle.
- > Hold the thread at the thread ends and pull back and forth several times.
- > Remove the thread at the Looper End in thread feed direction.
- > Repeat the procedure for further Air Threader Nozzles with a clean thread.

Cleaning the suction feet

Cleaning the suction feet prevents the machine from slipping on the table at high sewing speed.

- > Remove dust and thread remnants from the suction feet with a damp cloth.

Oiling the machine

- > Regularly lubricate the upper looper joint with a drop of the supplied bernette overlock oil.

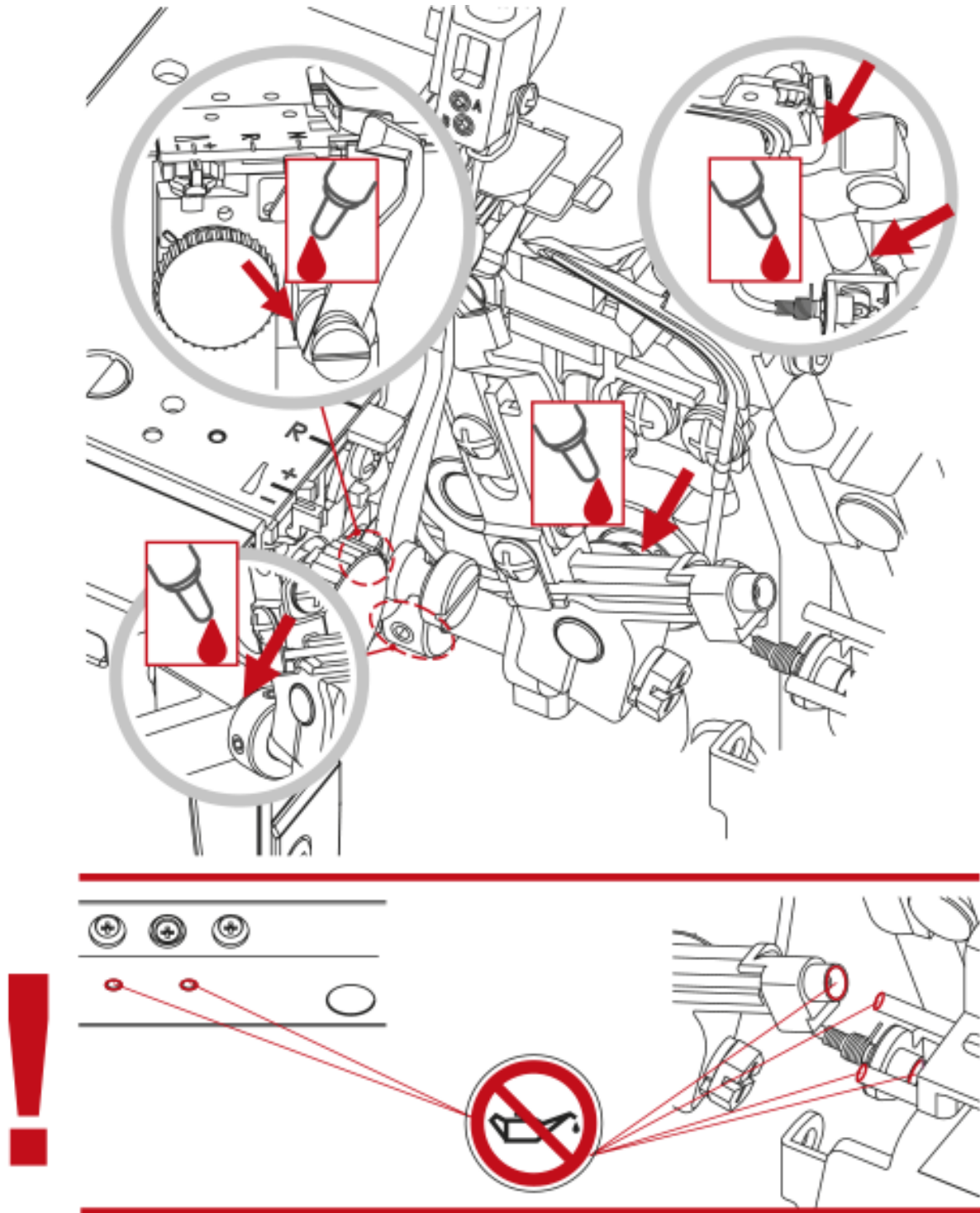

10.3 Troubleshooting

Fault	Solution
Fabric does not feed well.	<ul style="list-style-type: none"> > Lengthen the stitch length. > Increase the Presser Foot Pressure for heavyweight fabric. > Decrease the Presser Foot Pressure for lightweight fabrics. > Check the setting of the Differential Feed.
Needle breaks	<ul style="list-style-type: none"> > Insert the needle correctly. > Do not pull the fabric while sewing. > Tighten the Needle Set Screw. > Use a larger needle on heavyweight fabrics.
Thread breakage	<ul style="list-style-type: none"> > Loosen the Thread Tension. > Check the threading path. > Check for tangled or caught thread. > Insert the needle correctly. > Insert a new needle; inserted needles may be bent or have a blunt point. > Use high quality thread.
Skipped stitches	<ul style="list-style-type: none"> > Insert a new needle; the inserted needles may be bent or have a blunt point. > Tighten the Needle Set Screw. > Match the needle size with the fabric/thread. > Insert the needles correctly. > Change the type or size of the needles. > Check the threading path. > Increase the Presser Foot Pressure. > Balance the Thread Tension. > Use high quality thread.
Irregular stitches	<ul style="list-style-type: none"> > Balance the Thread Tension. > Check for tangled or caught thread. > Check the threading path.
Fabric puckers	<ul style="list-style-type: none"> > Check the setting of the Differential Feed. > Loosen the Thread Tension. > Check for tangled or caught thread. > Use high quality thread. > Shorten the stitch length. > Decrease the Presser Foot Pressure for lightweight fabrics.
Irregular trimming	<ul style="list-style-type: none"> > Check the alignment of the Knives. > Replace one or both Knives.
Fabric piles up	<ul style="list-style-type: none"> > Reduce the Presser Foot Pressure. > Check the setting of the Differential Feed. > Check for tangled or caught thread. > Compress/Baste thick layers of fabric with a conventional machine before sewing with the Overlocker.
Machine not running	<ul style="list-style-type: none"> > Connect machine to the power source and switch it on. > Close the Looper cover.

10.4 Specifications

Designation	Value	Unit
Number of stitches	16	
Number of loopers	2	
Number of needles	1 – 2	
Needle System	ELx705	
Needle Size	80 – 100 (12 – 16)	
Differential Feed	0.6 – 2.0	
Maximum fabric thickness	5.3 (0.23)	mm (in)
Stitch Length	1.0 – 5.0 (0.03 – 0.17)	mm (in)
Cutting Width Left Overlock Needle LN	5 – 7 (0.19 – 0.35)	mm (in)
Cutting Width Right Overlock Needle RN	3 – 5 (0.11 – 0.27)	mm (in)
Minimum sewing speed	300	Stitches per minute
Maximum sewing speed	1300	Stitches per minute
Dimensions without Retractable Thread Guide	43 x 27 x 29 (16.92/10.62/11.41)	cm (in)
Dimensions with Sewing Table / Cut-offs Bin	59 x 40 x 29 (23.22/15.78/11.41)	cm (in)
Weight of the machine	9.3 (20.46)	kg (lb)
Weight packaged	12.8 (28.2)	kg (lb)
Input voltage (energy consumption)	120 (80) / 230 – 240 (75)	Volt (W)
Protection class (electrical engineering)	II	
Date of manufacture	Visible on the type plate	



www.bernette.com/b64AIRLOCK

2020-09 EN
5040064.00A.04
© BERNINA International AG
Steckborn CH, www.bernina.com