



View this machine and more at:

<https://www.thesewingstudio.co.uk>

*Designer*  
*Topaz*<sup>TM</sup> 50  
Sampler





## ⊙ Lace insertion border

Hoop fabric and heavy water soluble stabilizer

Step 1

⊙ 1

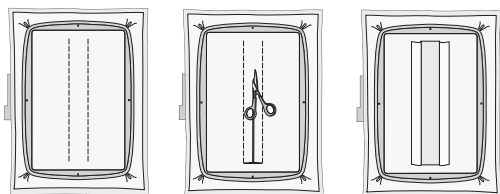

Embroider color #1. Cut fabric only between the stitched seams and fold and finger press the fabric over the stitching to each side.

Step 2

⊙ 2

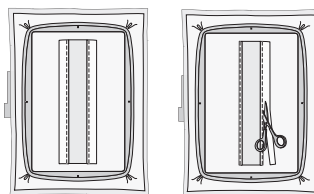

Embroider color #2. Trim away the excess fabric outside the stitching.

## Designs with THREAD VELVET™ technique

Cutting instructions to finish THREAD VELVET™ Embroidery:

To create the THREAD VELVET™ effect, cut the satin stitch down the middle from the right side. Avoid cutting the very last underlay of stitches for the best result.

To secure the thread for laundering, add textile glue to the wrong side of the embroidery to secure the threads.











Seam ripper 140000165





1

Stitches: 16 742  
Height: 256 mm  
Width: 124 mm

- 1  1032  
2292
- 2  1192  
2500
- 3  1020  
2582
- 4  1020  
2582
- 5  1822  
2489
- 6  1822  
2489
- 7  1015  
2593
- 8  1169  
2252
- 9  1191  
2262



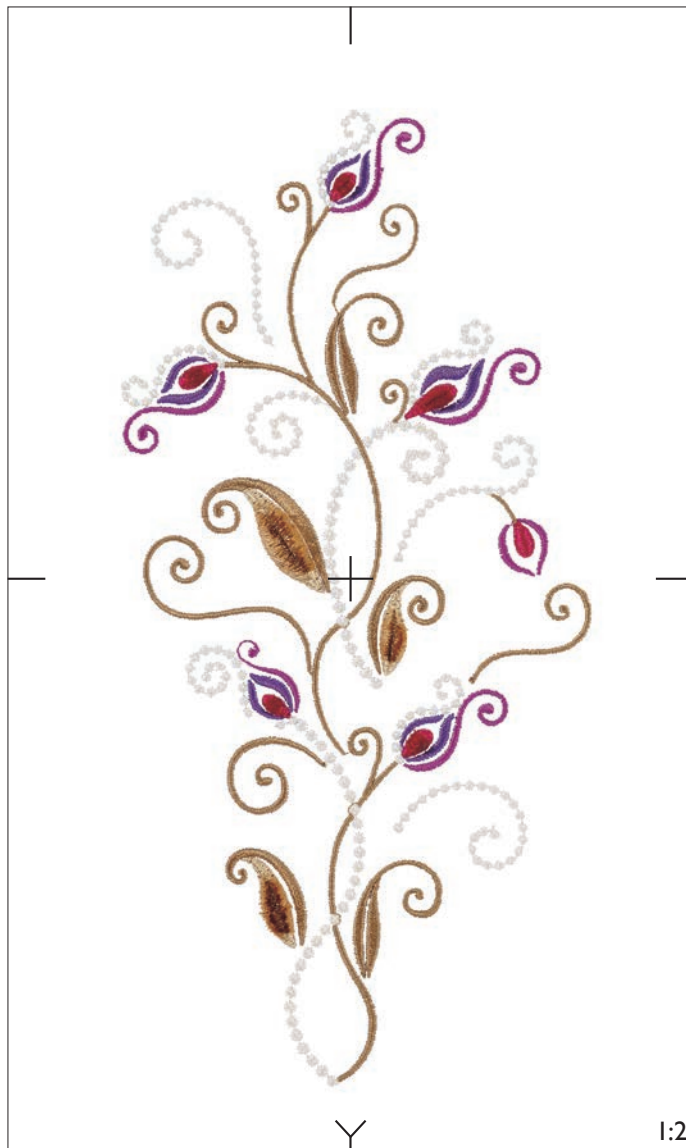

Gütermann Sulky  
Robison - Anton

∞ Thread Velvet™



2

Stitches: 27 312  
Height: 340 mm  
Width: 147 mm

- 1  1005  
2296
- 2  1041  
2407
- 3  1011  
2585
- 4  1005  
2296

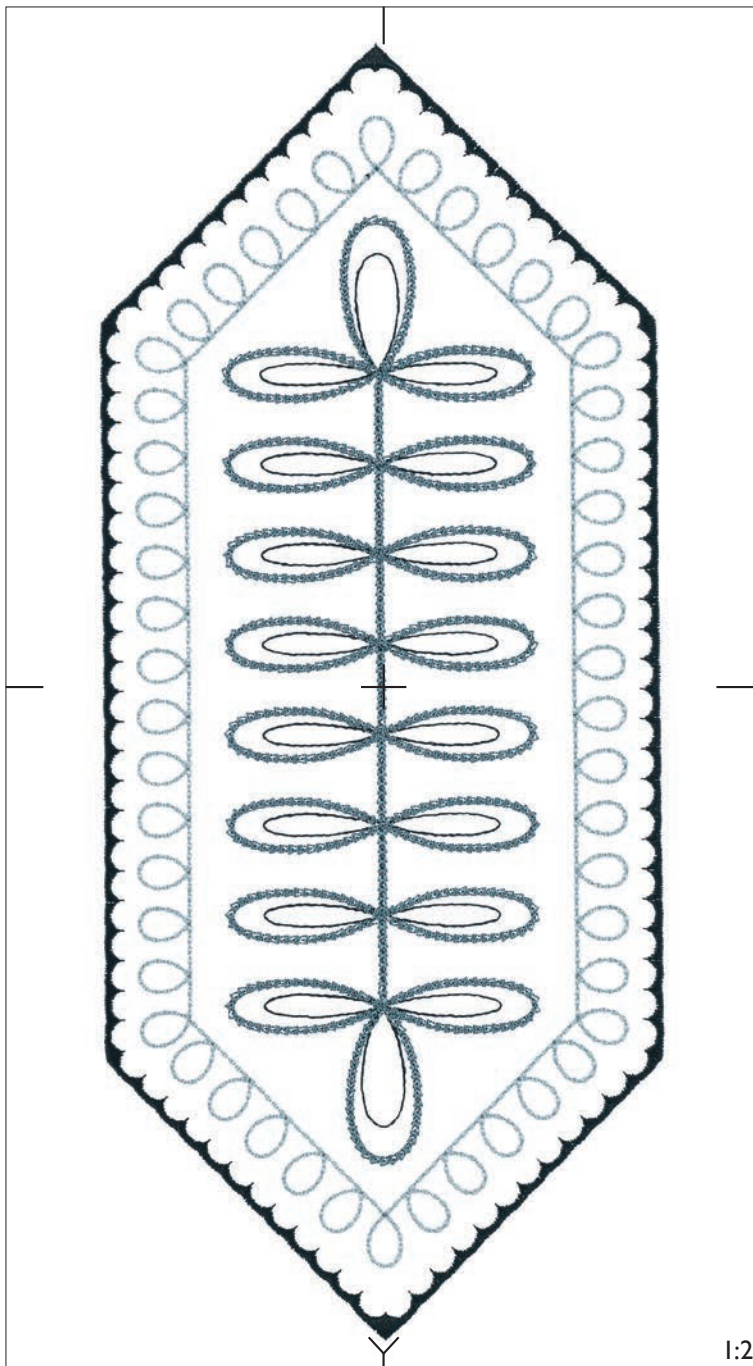

Gütermann Sulky  
Robison - Anton



1:2

3

Stitches: 3 879  
Height: 145 mm  
Width: 72 mm

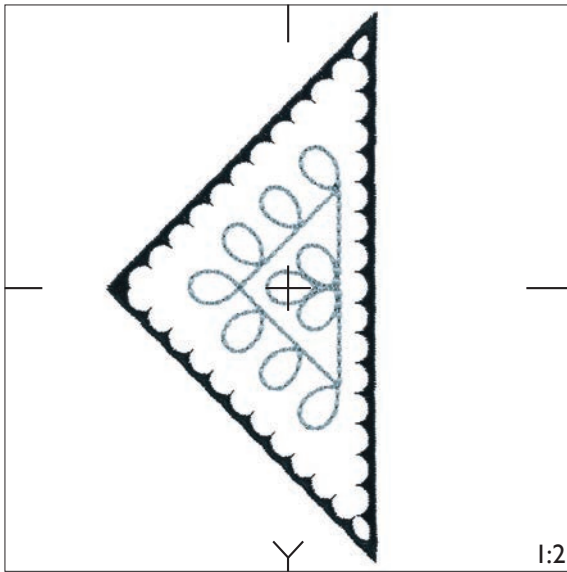

- 1  1011  
2585
- 2  1005  
2296

Gütermann Sulky  
Robison - Anton



4

Stitches: 15 263  
Height: 345 mm  
Width: 178 mm

- 1  1822  
2489
- 2  1822  
2489

Gütermann Sulky  
Robison - Anton

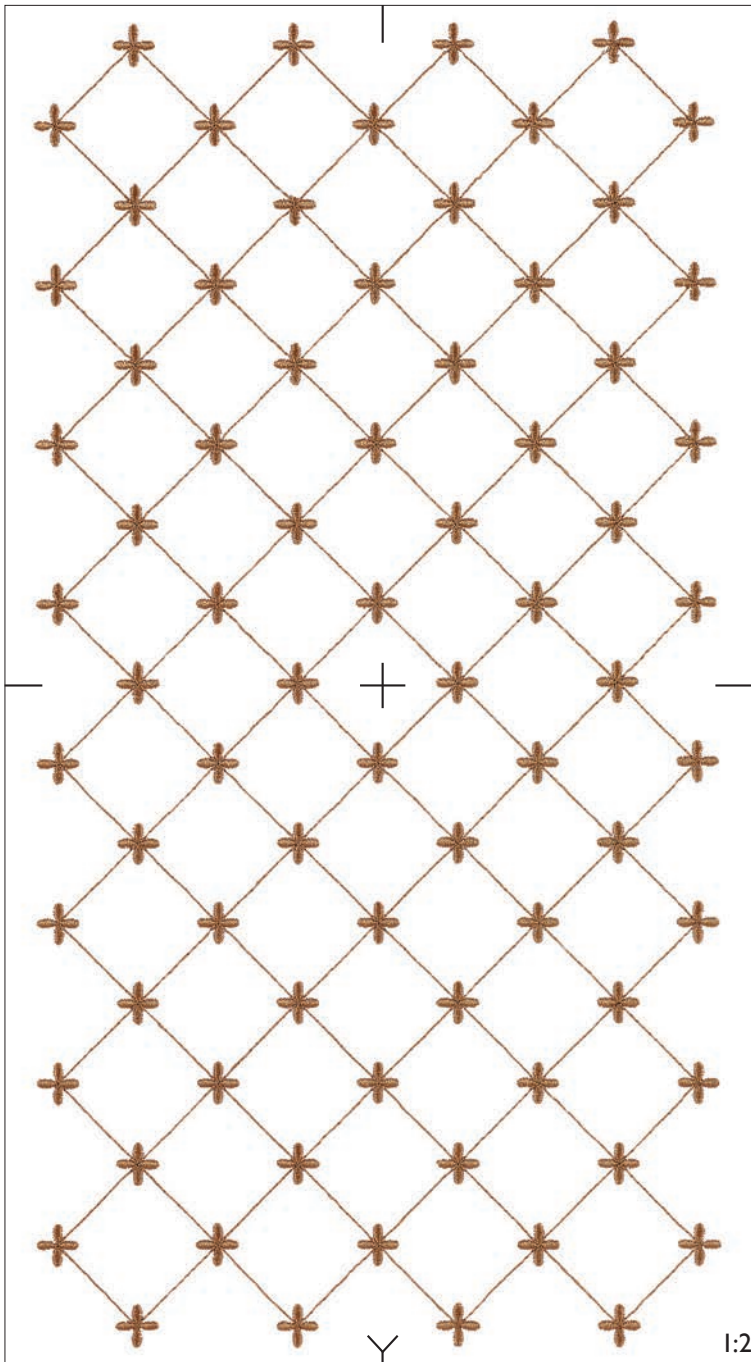



5

Stitches: 5 451  
Height: 72 mm  
Width: 42 mm

- 1 ■ 1005  
2296
- \* ■ 1005  
2296
- 2 ■ 1005  
2296
- ✂ 1005  
2296
- 3 ■ 1005  
2296

Gütermann Sulky  
Robison - Anton

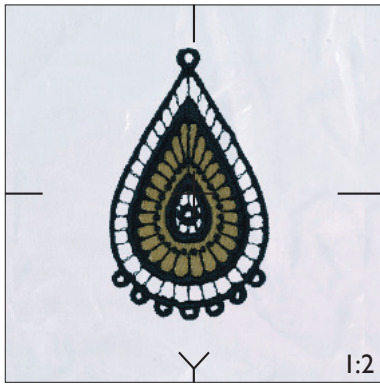

6

Stitches: 5 639  
Height: 71 mm  
Width: 93 mm

- 1 ■ 1005  
2296
- \* ■ 1005  
2296
- 2 ■ 1005  
2296
- 3 ■ 1813  
2380
- 4 ■ 1065  
2465
- 5 ■ 1230  
2621
- ✂ 1005  
2296
- 6 ■ 1005  
2296

Gütermann Sulky  
Robison - Anton

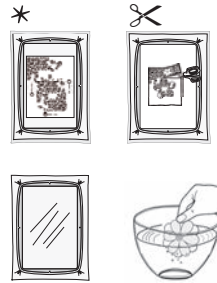
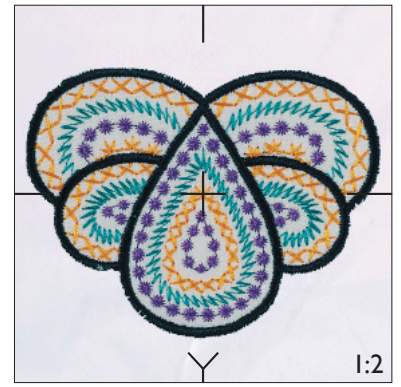

7

Stitches: 3 039  
Height: 350 mm  
Width: 164 mm





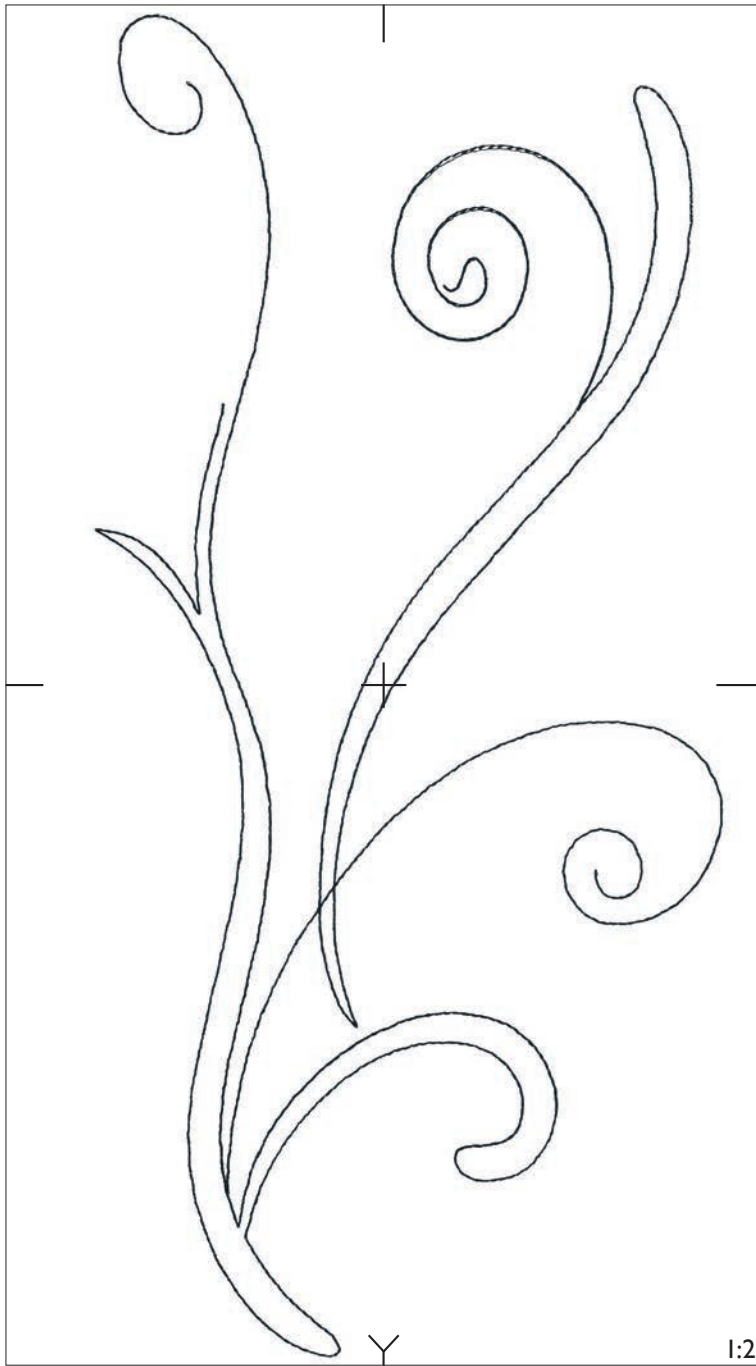





1 1005  
2296

Gütermann Sulky  
Robison - Anton



8

Stitches: 8 378  
Height: 100 mm  
Width: 107 mm

- 1  1005
- \*  2296
- 2  1005
-   2296
- 3  1041
-   2585
- 4  1005
-  2296





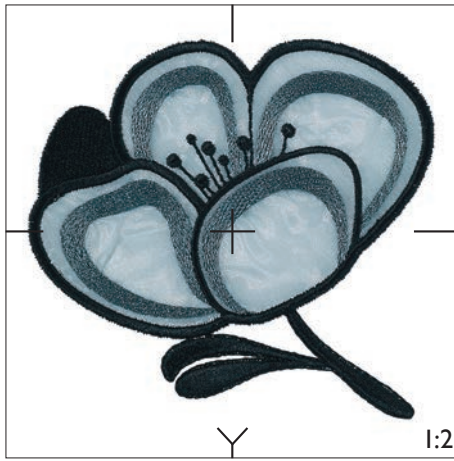





Gütermann Sulky  
Robison - Anton

\* Reversed  
appliqué



9

Stitches: 8 654  
Height: 105 mm  
Width: 83 mm

- 1  1005
- \*  2296
- 2  1005
-   2296
- 3  1041
-   2585
- 4  1005
-  2296

Gütermann Sulky  
Robison - Anton

\* Reversed  
appliqué

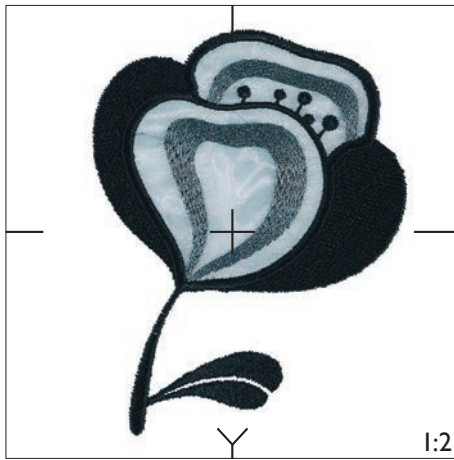

10

Stitches: 3 606  
Height: 166 mm  
Width: 66 mm

1 1813  
2426

Gütermann Sulky  
Robison - Anton

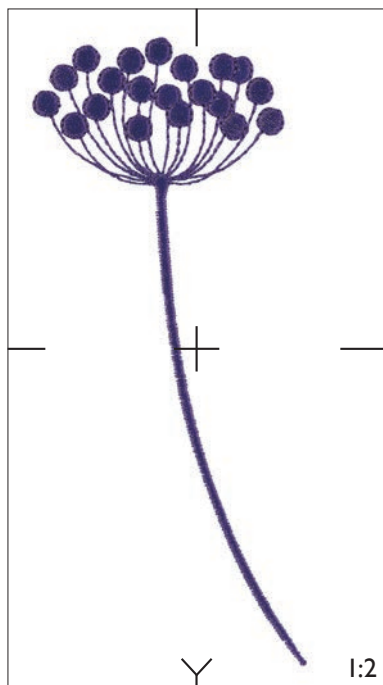

11

Stitches: 6 219  
Height: 60 mm  
Width: 60 mm

1 1813  
2426

2 1231  
2261

3 1813  
2426

4 1121  
2599

5 1001  
2343

Gütermann Sulky  
Robison - Anton

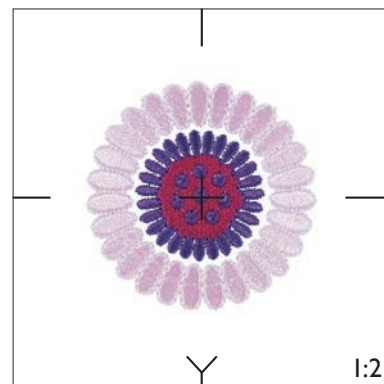

12

Stitches: 3 469  
Height: 64 mm  
Width: 64 mm

1 1121  
2599

2 1065  
2465

3 1813  
2426

Gütermann Sulky  
Robison - Anton

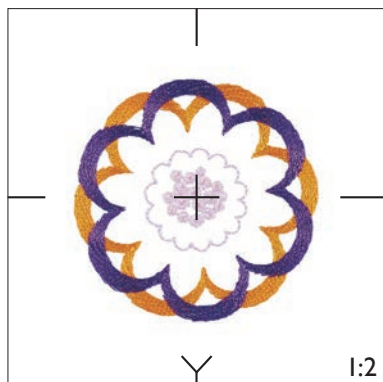

13

Stitches: 4 553  
Height: 60 mm  
Width: 44 mm



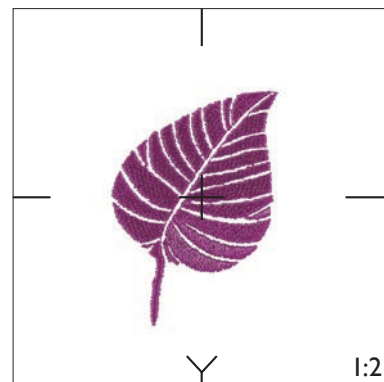

1 1231  
2261

Gütermann Sulky  
Robison - Anton



# 14

Stitches: 5 447  
 Height: 83 mm  
 Width: 101 mm





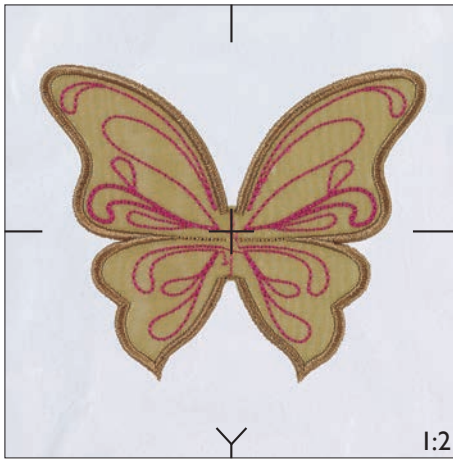
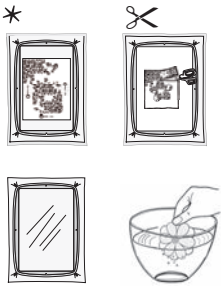

- 1  1822  
2489
- \*  1822  
2489
- 2  1822  
2489
- 3  1231  
2261
- ✂  1822  
2489

Gütermann Sulky  
 Robison - Anton



# 15

Stitches: 5 289  
 Height: 75 mm  
 Width: 83 mm



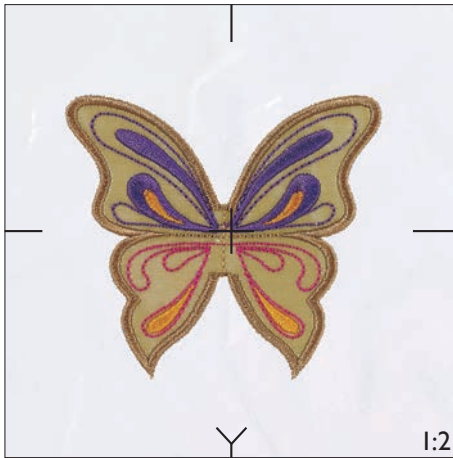

- 1  1822  
2489
- \*  1822  
2489
- 2  1822  
2489
- 3  1231  
2261
- 4  1813  
2426
- 5  1065  
2465
- ✂  1822  
2489

Gütermann Sulky  
 Robison - Anton



# 16

Stitches: 2 212  
 Height: 70 mm  
 Width: 43 mm

- 1  1005  
2296
- Δ  1005  
2296
- 2  1005  
2296
- 3  1231  
2261
- 4  1005  
2296

Gütermann Sulky  
 Robison - Anton

✂ Thread Velvet™

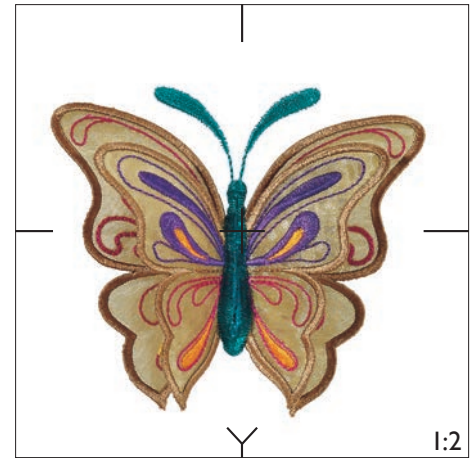
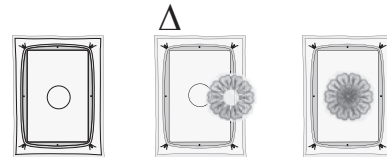

Stitches: 19 813  
Height: 340 mm  
Width: 191 mm

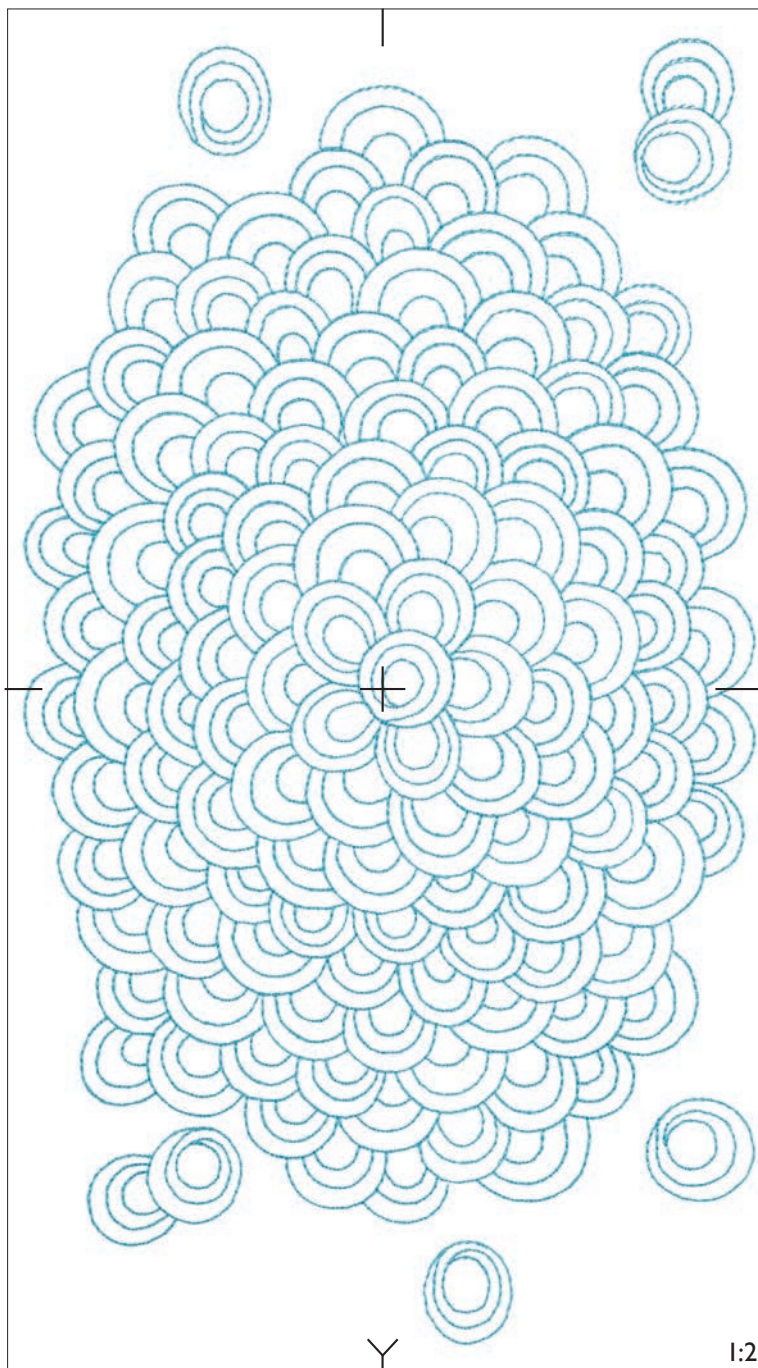

1  1288  
2204

Gütermann Sulky  
Robison - Anton



# 18

Stitches: 8 646  
Height: 111 mm  
Width: 130 mm





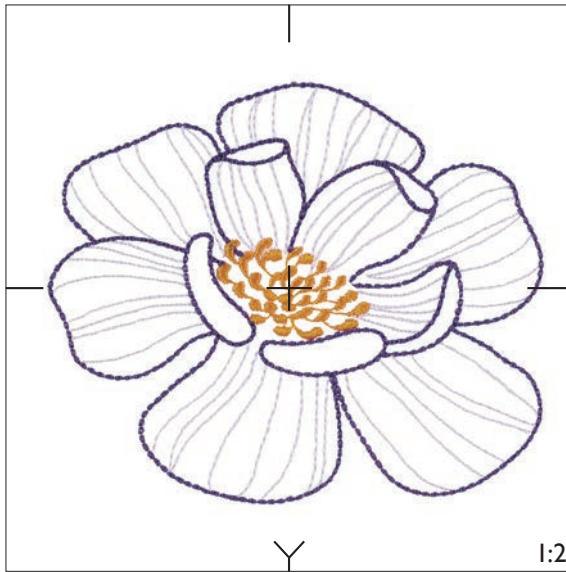

- 1  1121  
2599
- 2  1813  
2426
- 3  1065  
2465

Gütermann Sulky  
Robison - Anton



# 19

Stitches: 6 562  
Height: 108 mm  
Width: 110 mm

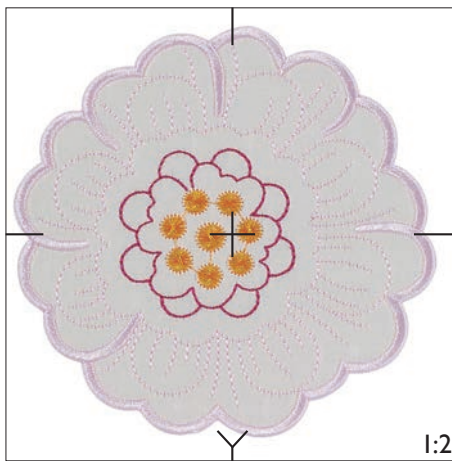
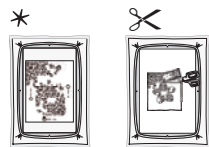

- 1  1121  
2599
- \*  1121  
2599
- 2  1121  
2599
- 3  1065  
2465
- 4  1231  
2261
- 5  1121  
2599
- 6  1121  
2599

Gütermann Sulky  
Robison - Anton



# 20

Stitches: 3 825  
Height: 140 mm  
Width: 140 mm

- 1  1231  
2261
- 2  1065  
2465

Gütermann Sulky  
Robison - Anton

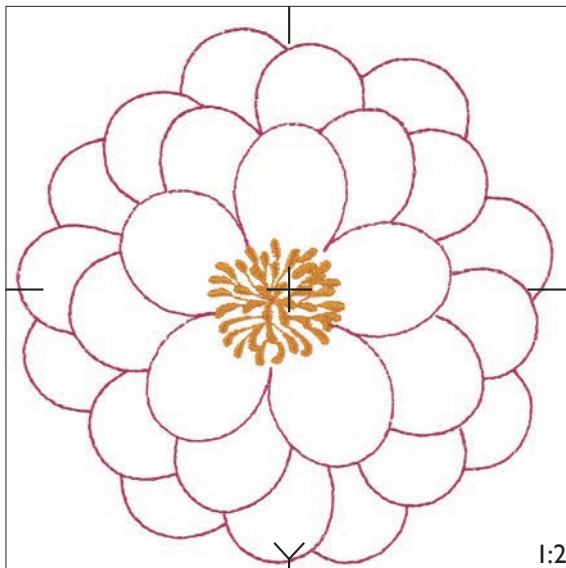

# 21

Stitches: 3 602  
Height: 145 mm  
Width: 145 mm

1  1288  
2204

Gütermann Sulky  
Robison - Anton

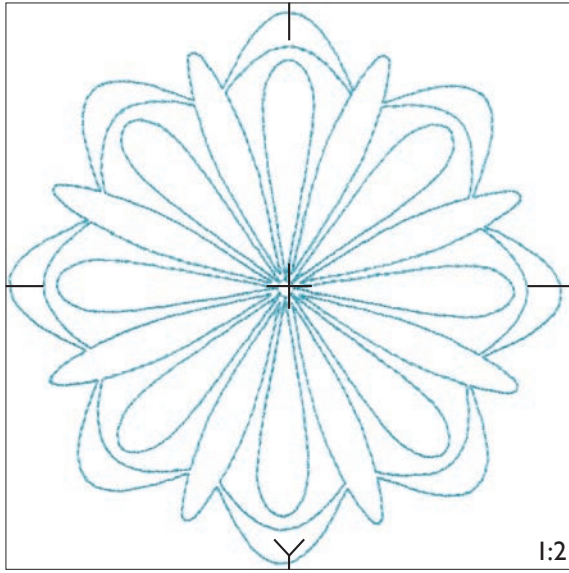

# 22

Stitches: 11 902  
Height: 135 mm  
Width: 135 mm

1  1288  
2204

2  1172  
2308

3  1082  
2335

4  1822  
2489

Gütermann Sulky  
Robison - Anton

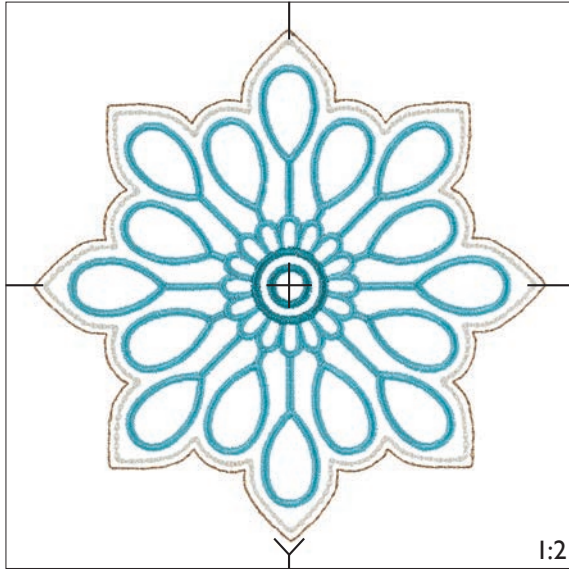

# 23

Stitches: 4 261  
Height: 65 mm  
Width: 65 mm

1  1065  
2465

Gütermann Sulky  
Robison - Anton

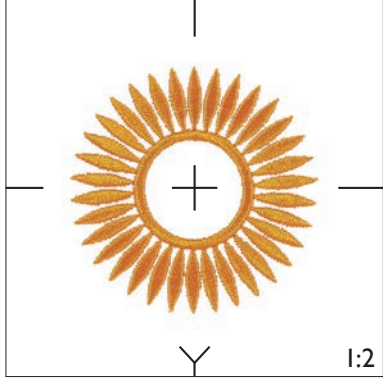



24

Stitches: 2 965  
Height: 45 mm  
Width: 45 mm

1  1231  
2261

Gütermann Sulky  
Robison - Anton

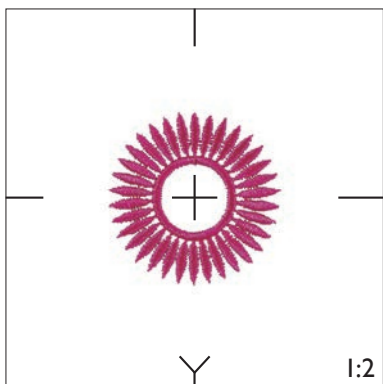

25

Stitches: 359  
Height: 14 mm  
Width: 14 mm

1  1231  
2261

Gütermann Sulky  
Robison - Anton

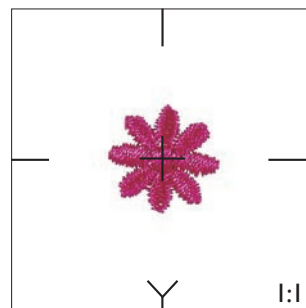

26

Stitches: 394  
Height: 16 mm  
Width: 16 mm

1  1813  
2380

Gütermann Sulky  
Robison - Anton

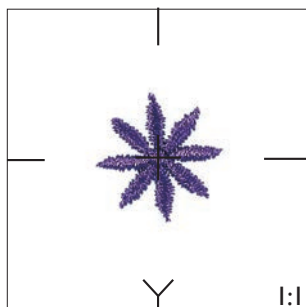

27

Stitches: 1 021  
Height: 20 mm  
Width: 20 mm

1  1288  
2204

Gütermann Sulky  
Robison - Anton

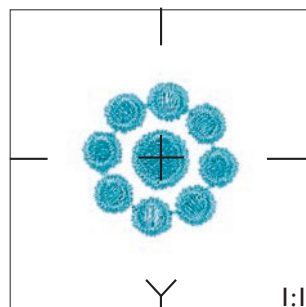

28

Stitches: 175  
Height: 11 mm  
Width: 10 mm

1  1065  
2465

Gütermann Sulky  
Robison - Anton

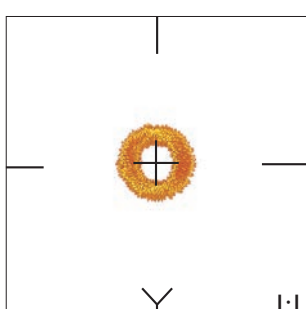

29

Stitches: 106  
Height: 7 mm  
Width: 6 mm

1  1231  
2261

Gütermann Sulky  
Robison - Anton

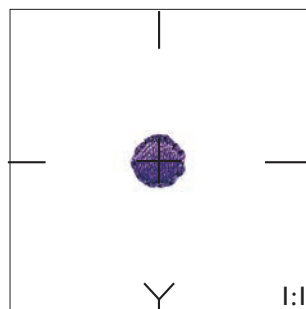



























30

Stiches: 28 978  
Height: 256 mm  
Width: 182 mm



- 1  1082  
2232
- 2  1056  
2569
- 3  1034  
2611
- 4  1035  
2622
- 5  1071  
2574
- 6  1239  
2401
- 7  567  
2401
- \*  567  
2401
- 8  567  
2401
- ✂  567  
2401
- 9  567  
2401
- 10  1074  
2300
- 11  1291  
2536
- 12  1283  
2386
- 13  1239  
2394
- 14  1158  
2569
- \*  1034  
2611
- 15  1034  
2611
- ✂  1034  
2611
- 16  1034  
2611
- 17  1035  
2622
- 18  1034  
2611
- 19  567  
2401
- 20  1170  
2402

1:2

Gütermann Sulky  
Robison - Anton

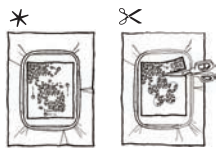

31

Stitches: 8 668  
Height: 256 mm  
Width: 181 mm











1 1056  
2569

Gütermann Sulky  
Robison - Anton



# 32

Stitches: 10 568  
Height: 223 mm  
Width: 195 mm

- 1  1082  
2332
- 2  1034  
2611
- \*  1034  
2611
- 3  1034  
2611
- 4  1034  
2611
- 5  1035  
2622
- 6  1034  
2611
- 7  1239  
2401
- 8  567  
2401
- 9  1170  
2402
- 10  1056  
2569

Gütermann Sulky  
Robison - Anton

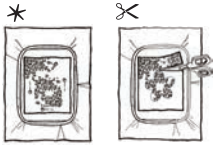

1:2

# 33

Stitches: 4 463  
Height: 223 mm  
Width: 195 mm

- 1  1056  
2569



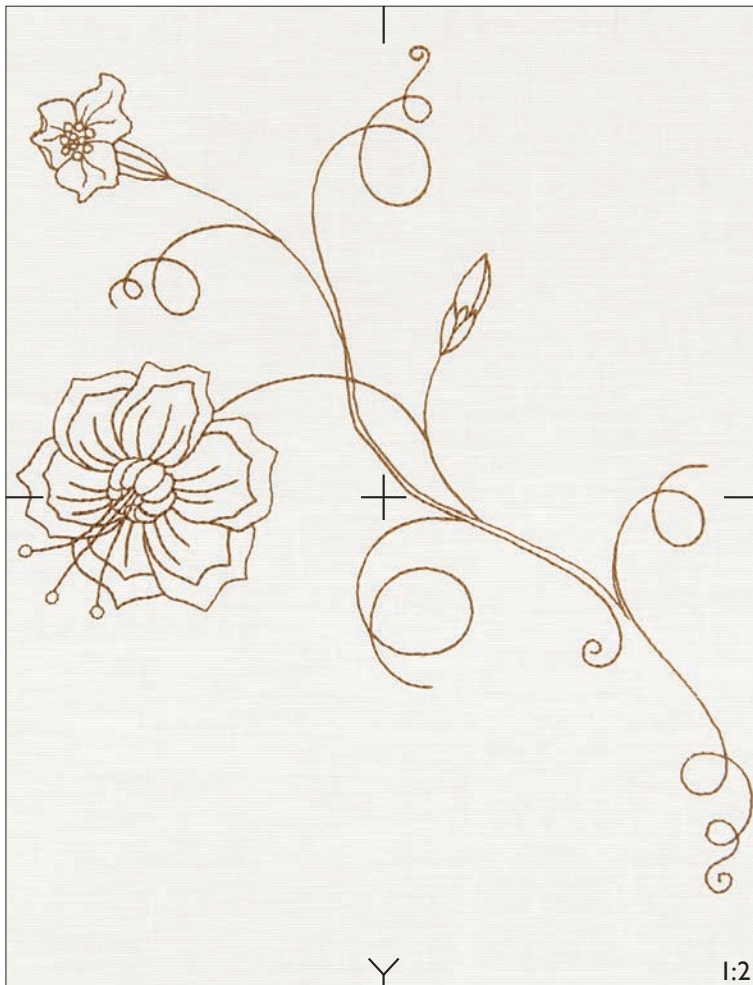











Gütermann Sulky  
Robison - Anton



1:2

# 34

Stitches: 12 292  
Height: 117 mm  
Width: 100 mm

- 1  1071  
2574
- \*  1071  
2574
- 2  1071  
2574
- 3  1071  
2574
- 4  1017  
2413
- 5  502  
2398
- 6  1034  
2611
- 7  1035  
2622
- 8  1239  
2394
- 9  1291  
2536
- 10  1283  
2386
- 11  1276  
2572
- 12  630  
2551
- 13  1057  
2251

Gütermann Sulky  
Robison - Anton

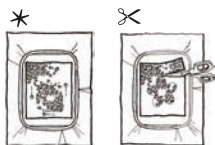

# 35

Stitches: 3 121  
Height: 117 mm  
Width: 100 mm

- 1  1056  
2569

Gütermann Sulky  
Robison - Anton

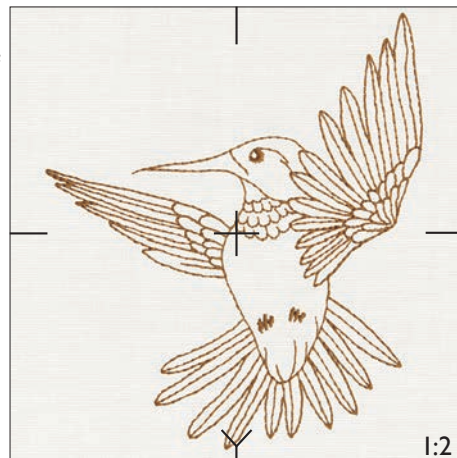

# 36

Stitches: 4 511  
Height: 78 mm  
Width: 74 mm

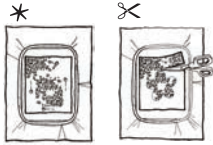

- 1 1034 2611
- \* 2 1034 2611
- 3 1034 2611
- 4 1035 2622
- 5 1034 2611
- 6 567 2401
- 7 1170 2402

Gütermann Sulky  
Robison - Anton

# 37

Stitches: 16 805  
Height: 64 mm  
Width: 64 mm

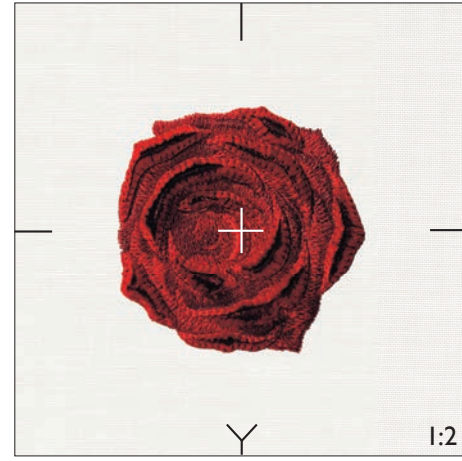

- 1 1169 2249
- 2 1039 2508
- 3 1169 2249
- 4 1039 2508

Gütermann Sulky  
Robison - Anton  
✂ Thread Velvet™

# 38

Stitches: 15 101  
Height: 60 mm  
Width: 75 mm

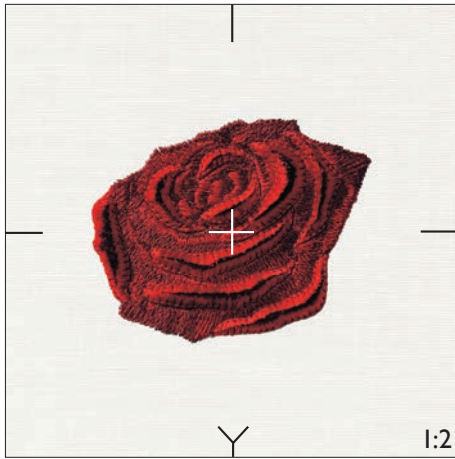

- 1 1169 2249
- 2 1039 2508
- 3 1169 2249
- 4 1039 2508

Gütermann Sulky  
Robison - Anton

✂ Thread Velvet™

# 39

Stitches: 10 219  
Height: 47 mm  
Width: 62 mm

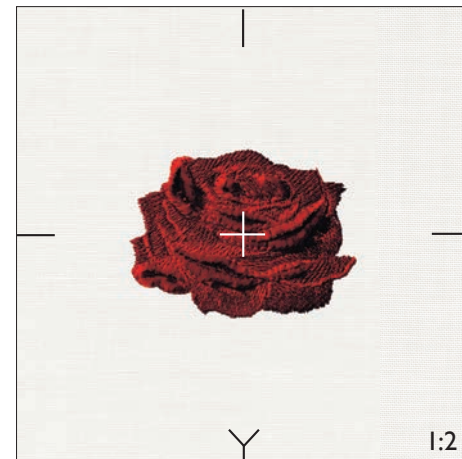

- 1 1169 2249
- 2 1039 2508
- 3 1263 2263
- 4 1039 2508

Gütermann Sulky  
Robison - Anton  
✂ Thread Velvet™

# 40

Stitches: 4 714  
Height: 95 mm  
Width: 42 mm

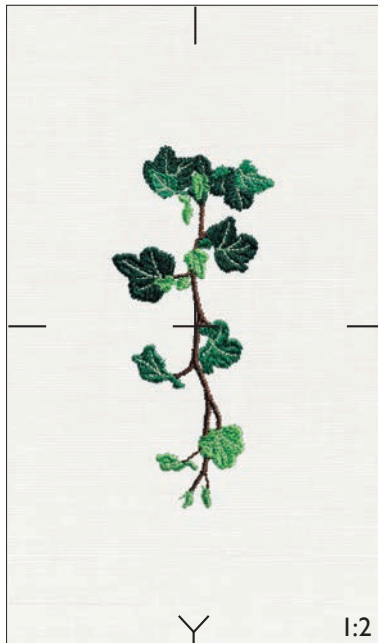

- 1 1057 2478
- 2 1550 2631
- 3 1208 2284
- 4 1177 2321
- 5 1176 2279

Gütermann Sulky  
Robison - Anton

# 41

Stitches: 15 077  
Height: 124 mm  
Width: 89 mm

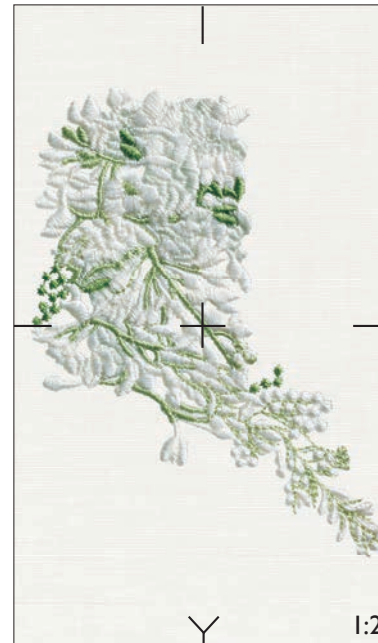





- 1 1063 2316
- 2 1001 2343
- 3 1177 2457
- 4 1104 2547

Gütermann Sulky  
Robison - Anton

42

Stitches: 10 530  
 Height: 130 mm  
 Width: 84 mm

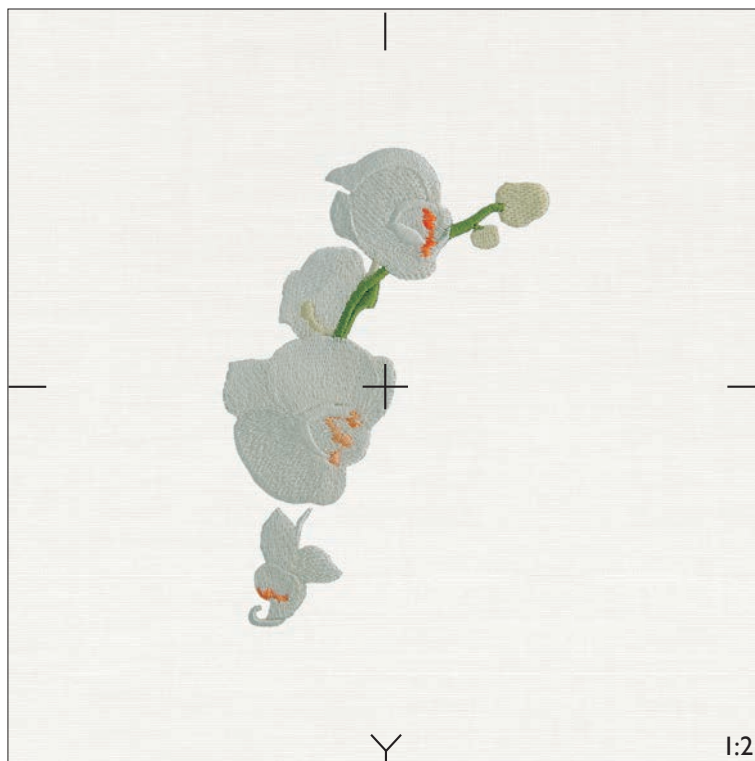

- |   |   |              |
|---|---|--------------|
| 1 |  | I022<br>2316 |
| 2 |  | I177<br>2457 |
| 3 |  | I002<br>2574 |
| 4 |  | I071<br>2574 |
| 5 |  | 2103<br>2328 |

Gütermann Sulky  
 Robison - Anton



43

Stitches: 1 789  
 Height: 24 mm  
 Width: 24 mm

- |   |   |              |
|---|---|--------------|
| 1 |  | I224<br>2237 |
| 2 |  | I120<br>2582 |

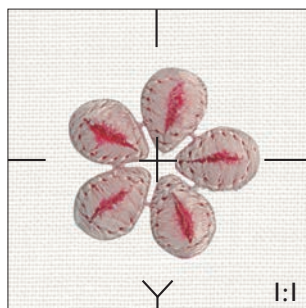

Gütermann Sulky  
 Robison - Anton

✂ Thread Velvet™



44

Stitches: 2 318  
 Height: 71 mm  
 Width: 64 mm

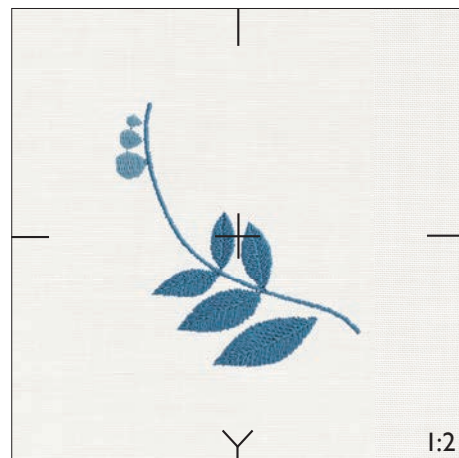

- |   |   |              |
|---|---|--------------|
| 1 |  | I222<br>2239 |
| 2 |  | I134<br>2433 |

Gütermann Sulky  
 Robison - Anton



45

Stitches: 3 174  
 Height: 84 mm  
 Width: 122 mm

- |   |   |              |
|---|---|--------------|
| 1 |  | I104<br>2547 |
| 2 |  | I206<br>2521 |

Gütermann Sulky  
 Robison - Anton

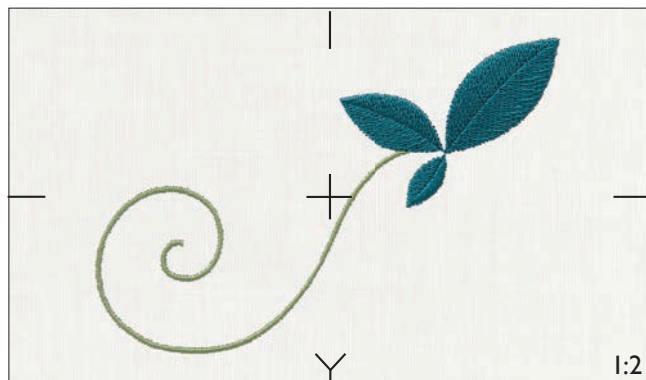



# 46

Stitches: 3 897  
Height: 69 mm  
Width: 71 mm

- 1  1222  
2239
- 2  1104  
2547

Gütermann Sulky  
Robison - Anton

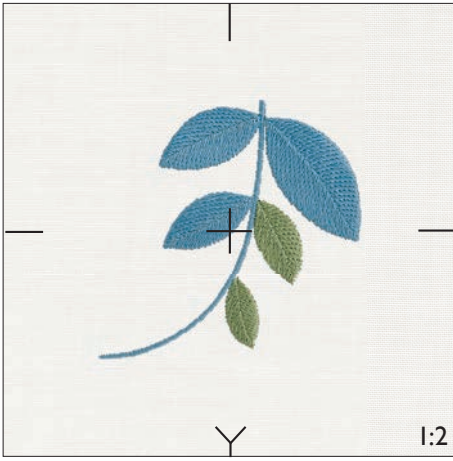

# 47

Stitches: 2 257  
Height: 84 mm  
Width: 60 mm

- 1  1238  
2409
- 2  1104  
2547

Gütermann Sulky  
Robison - Anton

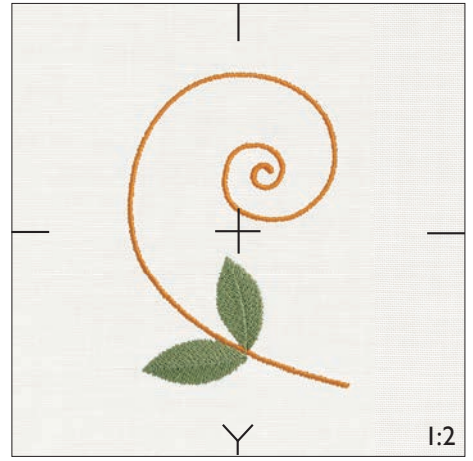

# 48

Stitches: 2 485  
Height: 47 mm  
Width: 97 mm

- 1  1224  
2237
- 2  1231  
2261
- 3  1039  
2508

Gütermann Sulky  
Robison - Anton

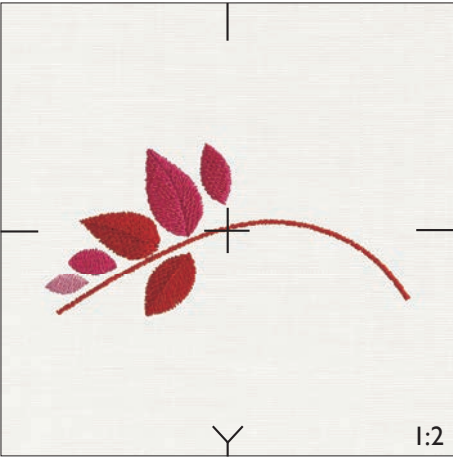

# 49

Stitches: 1 388  
Height: 69 mm  
Width: 48 mm

- 1  1206  
2521

Gütermann Sulky  
Robison - Anton

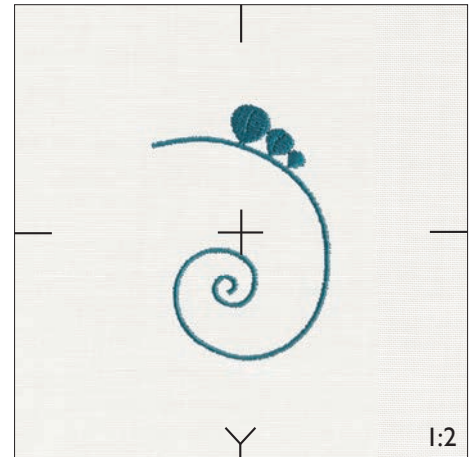

# 50

Stitches: 4 395  
Height: 41 mm  
Width: 77 mm

- 1  1121  
2599
- 2  1231  
2261
- 3  1224  
2237

Gütermann Sulky  
Robison - Anton

⌘ Thread Velvet™

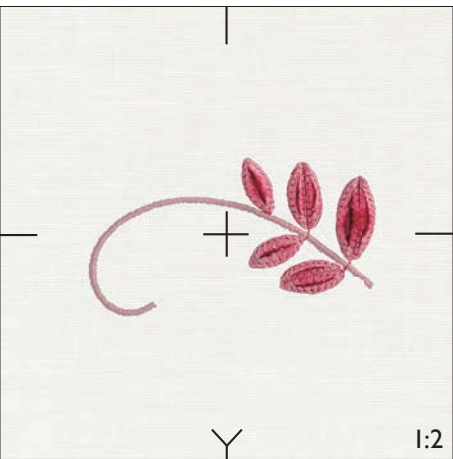

# 51

Stitches: 5 654  
Height: 77 mm  
Width: 48 mm

- 1  1104  
2547
- 2  1134  
2433
- 3  1222  
2239

Gütermann Sulky  
Robison - Anton

⌘ Thread Velvet™

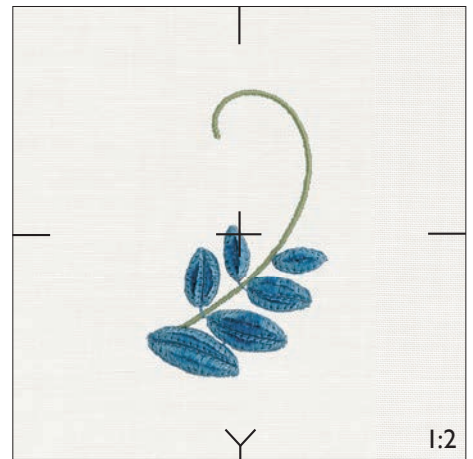

Stitches: 75 324  
 Height: 341 mm  
 Width: 195 mm









- 1  1206  
2521
- 2  1120  
2582
- 3  1121  
2599
- 4  1238  
2409
- 5  1222  
2239
- 6  1104  
2547
- 7  1224  
2237
- 8  1206  
2521
- 9  1134  
2433
- 10  1231  
2261
- 11  1039  
2508

Gütermann Sulky  
 Robison - Anton

✂ Thread Velvet™





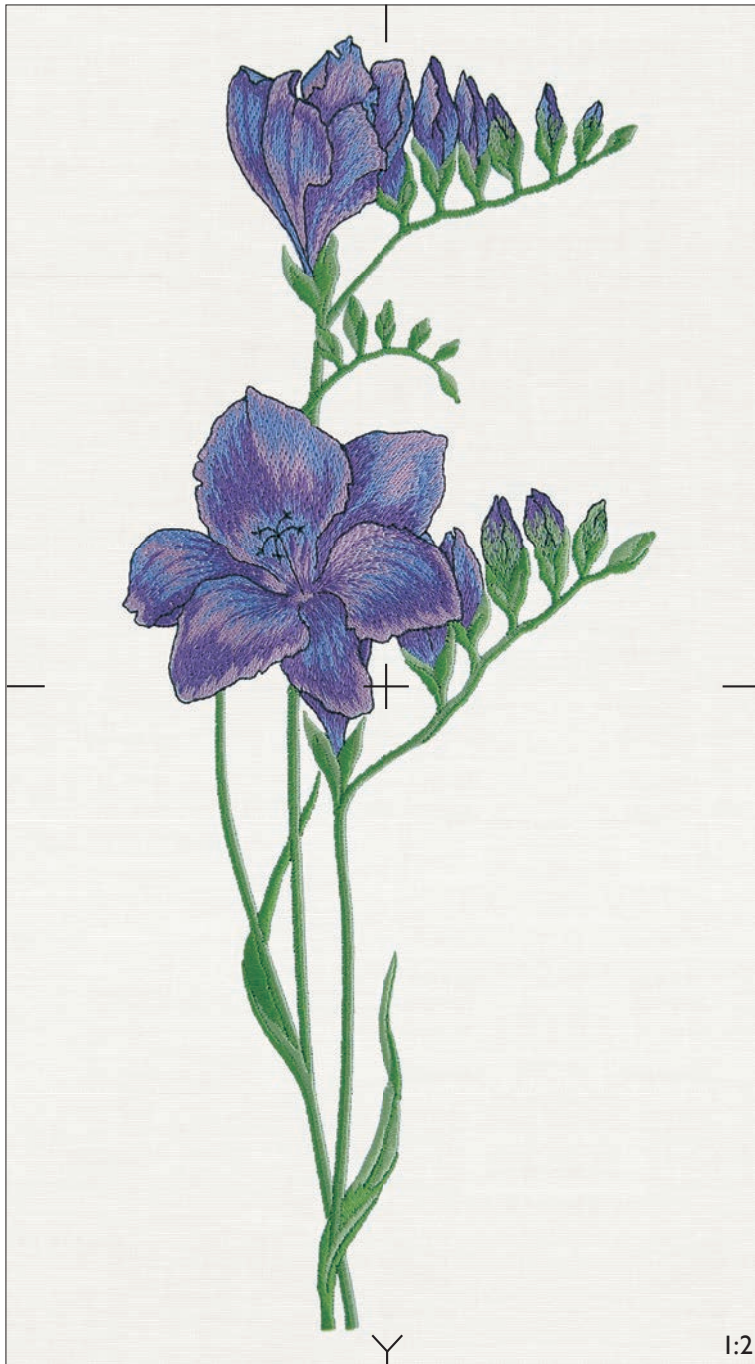

Stiches: 38 548  
Höhe: 342 mm  
Breite: 140 mm

- |   |   |              |
|---|---|--------------|
| 1 |  | 1031<br>2340 |
| 2 |  | 1254<br>2286 |
| 3 |  | 1031<br>2340 |
| 4 |  | 1032<br>2288 |
| 5 |  | 1177<br>2457 |
| 6 |  | 1104<br>2547 |
| 7 |  | 1220<br>2217 |
| 8 |  | 1104<br>2547 |
| 9 |  | 1177<br>2457 |

Gütermann Sulky  
Robison - Anton



Stitches: 31 595  
Height: 342 mm  
Width: 188 mm







- |   |   |              |
|---|---|--------------|
| 1 |  | 1177<br>2457 |
| 2 |  | 1104<br>2547 |
| 3 |  | 1232<br>2315 |
| 4 |  | 1001<br>2343 |

Gütermann Sulky  
Robison - Anton



55







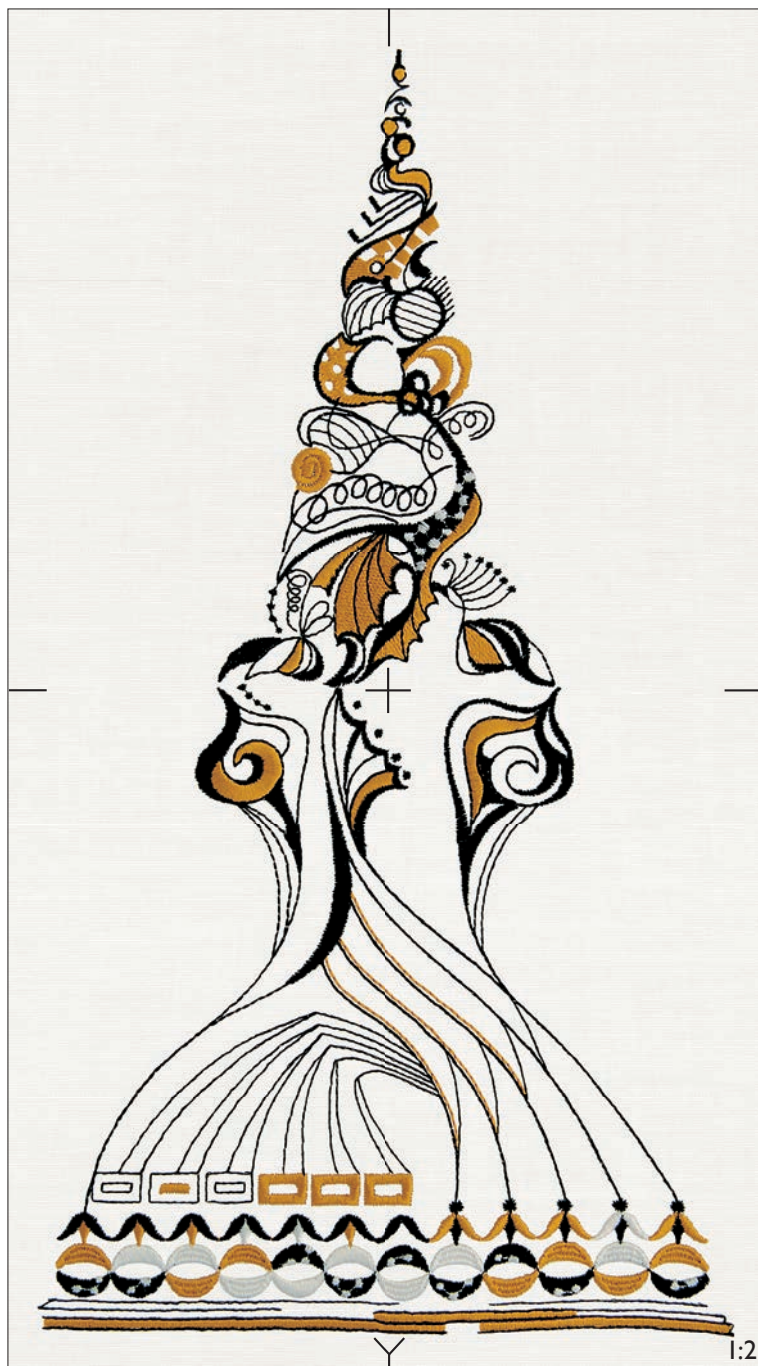















Stiches: 28 888  
Höhe: 340 mm  
Weite: 185 mm

- 1  1025  
2400
- 2  1005  
2296
- 3  1001  
2343
- 4  1025  
2400
- 5  1005  
2296
- 6  1001  
2343

Gütermann Sulky  
Robison - Anton



Stitches: 57 529  
 Height: 336 mm  
 Width: 70 mm

- 1  1022  
2316
- 2  1022  
2316
- 3  1031  
2340
- 4  1022  
2316
- 5  1194  
2288
- 6  1104  
2547
- 7  1276  
2572
- 8  1332  
2279
- 9  1104  
2547
- 10  1177  
2457
- 11  1272  
2317
- 12  1022  
2316
- 13  1022  
2316
- 14  1031  
2340
- 15  1022  
2316
- 16  1194  
2288
- 17  1104  
2547
- 18  1276  
2572
- 19  1332  
2279
- 20  1104  
2547
- 21  1177  
2457
- 22  1272  
2317

Gütermann Sulky  
 Robison - Anton

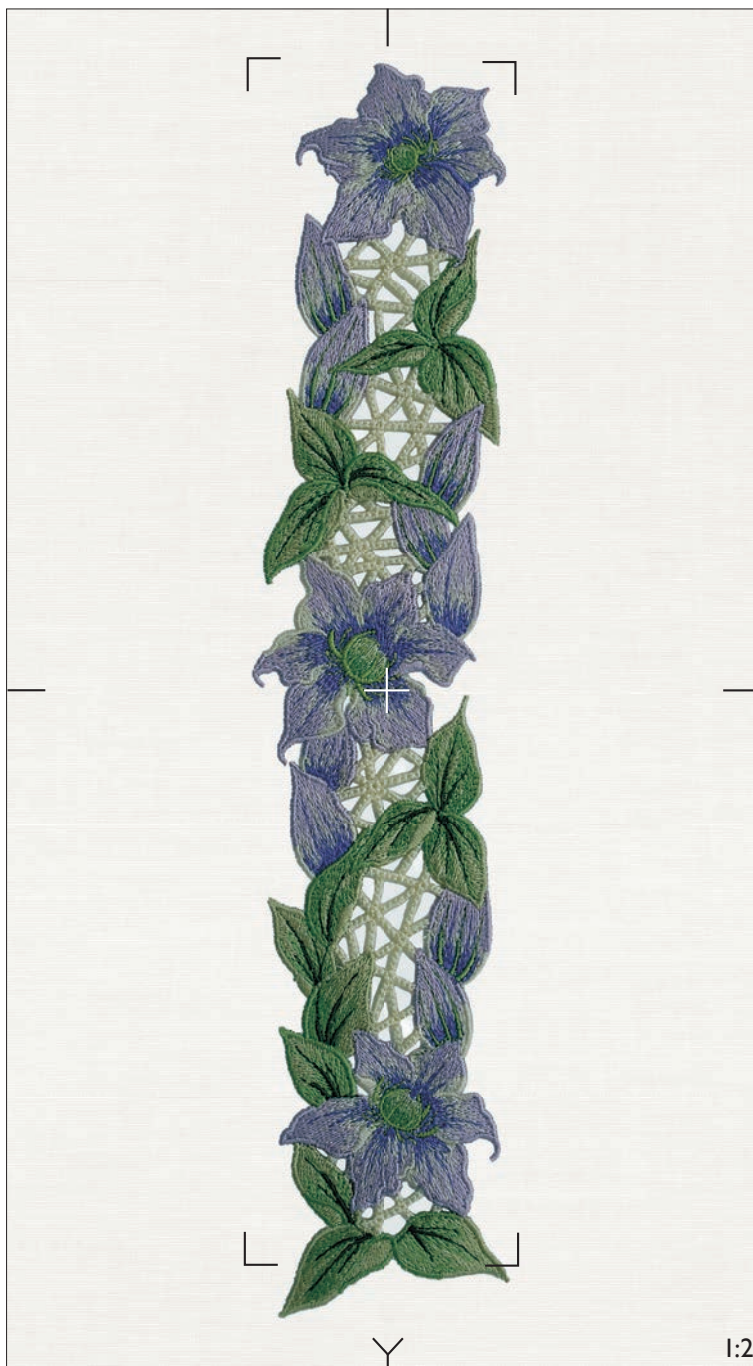

187 Mega Richelieu, design #9



# 57

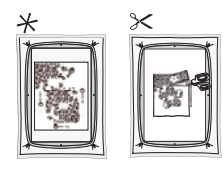
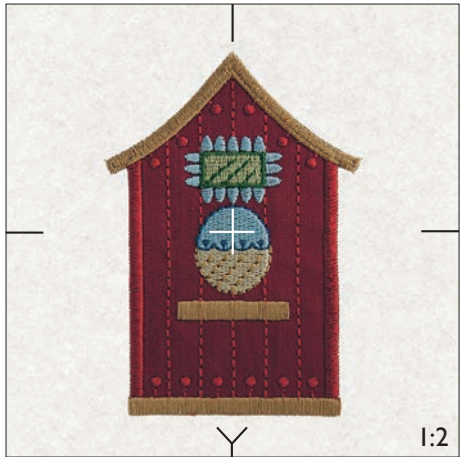

Stitches: 6 275  
Height: 98 mm  
Width: 69 mm

- 1 1034 2611
- 2 1034 2611
- \* 1034 2611
- 3 1034 2611
- ✂ 1127 2476
- 4 1127 2476
- 5 1128 2273
- 6 1248 2239
- 7 1042 2210
- 8 1104 2547
- 9 1176 2595

Gütermann Sulky  
Robison - Anton

# 58

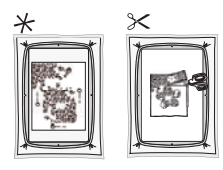
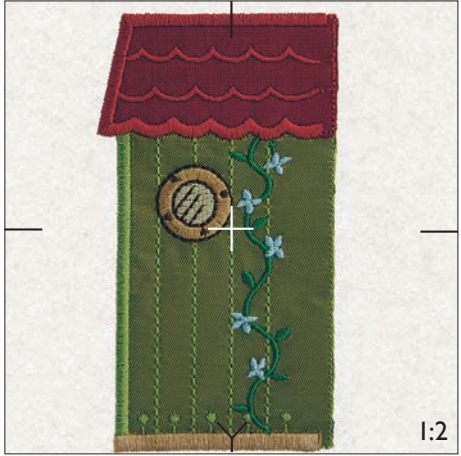

Stitches: 6 168  
Height: 117 mm  
Width: 64 mm

- 1 1177 2457
- \* 1177 2457
- 2 1177 2457
- 3 1177 2457
- 4 1051 2453
- 5 1248 2239
- 6 1127 2476
- 7 1128 2273
- 8 1129 2372
- 9 1034 2611
- \* 1034 2611
- 10 1034 2611
- ✂ 1034 2611
- 11 1034 2611

Gütermann Sulky  
Robison - Anton



# 59

Stitches: 36 037  
Height: 347 mm  
Width: 183 mm

- |             |              |              |              |
|-------------|--------------|--------------|--------------|
| 1 1056 2231 | 6 1104 2547  | 13 1056 2231 | 20 1117 2276 |
| 2 1070 2557 | 7 1176 2595  | 14 1129 2569 | 21 1147 2263 |
| 3 1129 2372 | 8 1248 2239  | 15 1170 2402 | 22 1177 2457 |
| 4 1117 2276 | 9 1042 2210  | 16 1104 2547 | 23 1176 2595 |
| 5 1147 2263 | 10 1127 2476 | 17 1176 2595 | 24 0502 2398 |
|             | 11 1082 2232 | 18 1135 2234 | 25 1028 2206 |
|             | 12 1128 2273 | 19 1023 2561 | 26 1028 2206 |

Gütermann Sulky  
Robison - Anton

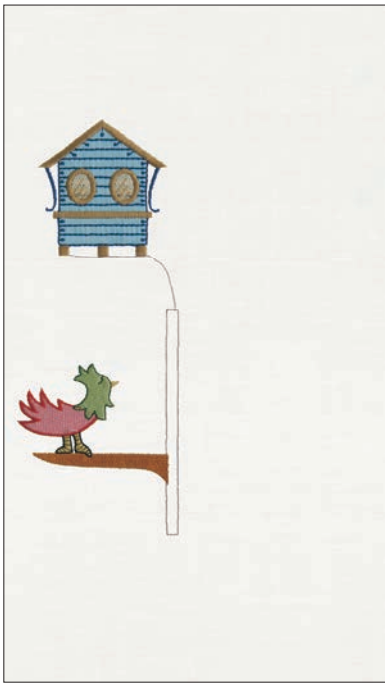

Step 1

- |   |  |      |   |  |      |    |  |      |
|---|--|------|---|--|------|----|--|------|
| 1 |  | 1056 | 5 |  | 1147 | 9  |  | 1042 |
|   |  | 2231 |   |  | 2263 |    |  | 2210 |
| 2 |  | 1070 | 6 |  | 1104 | 10 |  | 1127 |
|   |  | 2557 |   |  | 2547 |    |  | 2476 |
| 3 |  | 1129 | 7 |  | 1176 | 11 |  | 1082 |
|   |  | 2372 |   |  | 2595 |    |  | 2232 |
| 4 |  | 1117 | 8 |  | 1248 | 12 |  | 1128 |
|   |  | 2276 |   |  | 2239 |    |  | 2273 |



Step 2

design #42



Step 3

- |    |  |      |
|----|--|------|
| 13 |  | 1056 |
|    |  | 2231 |



Step 4

- |    |  |      |    |  |      |    |  |      |
|----|--|------|----|--|------|----|--|------|
| 14 |  | 1129 | 18 |  | 1135 | 22 |  | 1177 |
|    |  | 2569 |    |  | 2234 |    |  | 2457 |
| 15 |  | 1170 | 19 |  | 1023 | 23 |  | 1176 |
|    |  | 2402 |    |  | 2561 |    |  | 2595 |
| 16 |  | 1104 | 20 |  | 1117 | 24 |  | 0502 |
|    |  | 2547 |    |  | 2276 |    |  | 2398 |
| 17 |  | 1176 | 21 |  | 1147 |    |  |      |
|    |  | 2595 |    |  | 2263 |    |  |      |



Step 5

- |    |  |      |
|----|--|------|
| 25 |  | 1028 |
|    |  | 2206 |

design #41









Step 6

- |    |  |
|----|--|
| 26 |  |
|----|--|



Stitches: 26 864  
 Height: 348 mm  
 Width: 146 mm

- 1  7013  
2509
- 2  1309  
2418
- 3  1188  
2509
- 4  1231  
2261
- 5  7055  
2205
- A\*  1188  
2509

Gütermann Sulky  
 Robison - Anton

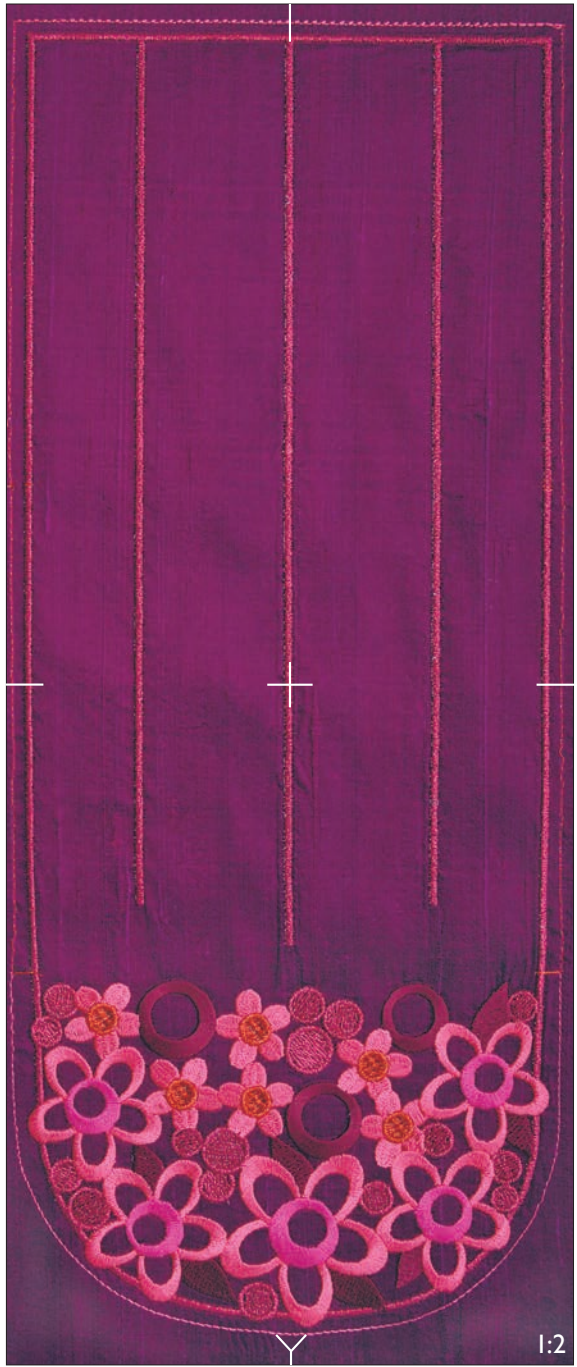

Supplies:

- 2 pcs of fabric 20"x12" (50x30 cm)
- 1 piece of stabilizer 20"x12" (50x30 cm)
- assorted embroidery threads.

184 Purse Pizzazz,  
 design #3

1:2

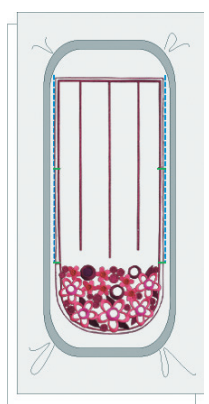

Hoop 1 piece of fabric and stabilizer. Embroider color #1-5.

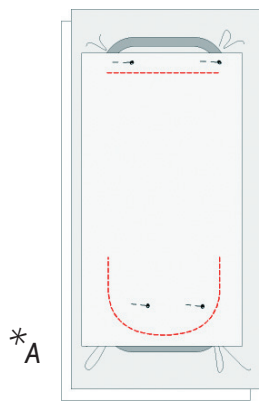

Place lining on top of the embroidery, right side down. Embroider color #6.

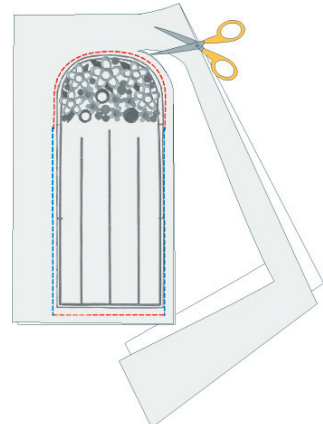



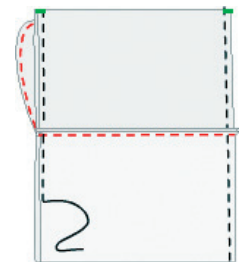









Remove from hoop. Tear away the stabilizer. Cut 3/8" (1 cm) outside the basting stitches.



Fold right sides together at the stitched marks, marked in green on the picture. Sew the sides together. Leave an opening in the lining. Turn the right side out and press.







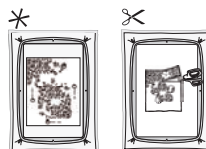











Stiches: 19 232  
Height: 251 mm  
Width: 160 mm

- 1  1021  
2289
- \*  1021  
2289
- 2  1021  
2289
- 3  1021  
2289
- 4  1239  
2394
- 5  1129  
2372
- 6  1170  
2402
- 7  1177  
2457
- 8  1156  
2545
- 9  1175  
2392
- 10  1032  
2288
- 11  1235  
2428
- 12  1001  
2343

Gütermann Sulky  
Robison - Anton



Stitches: 25 025  
 Height: 255 mm  
 Width: 145 mm

- 1  1258  
2473
- 2  1149  
2593
- 3  1180  
2572
- 4  1001  
2343
- 5  1169  
2249
- 6  1059  
2576
- 7  1070  
2557
- 8  1032  
2288
- \* 9  1190  
2611
- ✂ 10  1190  
2611
- 11  1119  
2591
- \* 12  1190  
2611
- ✂ 13  1119  
2591
- 14  1023  
2561
- 15  1154  
2412
- 16  1254  
2286
- 17  1071  
2574
- 18  1002  
2574

✂ Thread Velvet™

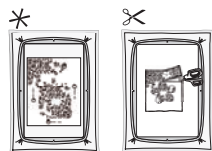

Stitches: 29 044  
 Height: 249 mm  
 Width: 187 mm

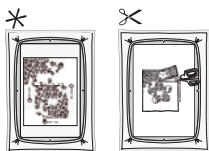

- 1  1165  
2283
- \*  1165  
2283
- 2  1165  
2283
- ✂  1165  
2283
- 3  1165  
2283
- 4  1001  
2343
- \*  1001  
2343
- 5  1001  
2343
- ✂  1001  
2343
- 6  1001  
2343
- \*  1001  
2343
- 7  1001  
2343
- ✂  1001  
2343
- 8  1001  
2343
- \*  1001  
2343
- 9  1001  
2343
- ✂  1001  
2343
- 10  1001  
2343
- 11  1023  
2560
- 12  1025  
2400
- 13  1321  
2241
- 14  1216  
2205
- 15  1056  
2569
- 16  1129  
2372
- 17  1001  
2343
- 18  1218  
2485



Gütermann Sulky  
 Robison - Anton

64

Stitches: 269  
Height: 12 mm  
Width: 12 mm

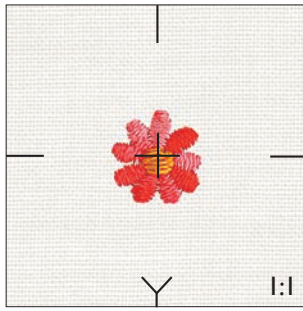

- 1  2102  
2262
- 2  1137  
2331

Gütermann Sulky  
Robison - Anton



65

Stitches: 482  
Height: 27 mm  
Width: 16 mm

- 1  1028  
2206
- 2  1032  
2288
- 3  1076  
2528

Gütermann Sulky  
Robison - Anton

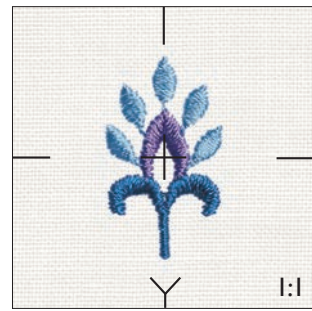

154 Elegant Elements, design #69

66

Stitches: 340  
Height: 17 mm  
Width: 18 mm

- 1  1076  
2528

Gütermann Sulky  
Robison - Anton

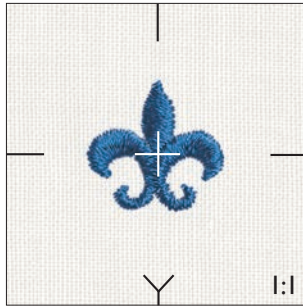

154 Elegant Elements, design #73

67

Stitches: 3 146  
Height: 127 mm  
Width: 96 mm

1 ■ 1234  
2296

Gütermann Sulky  
Robison - Anton

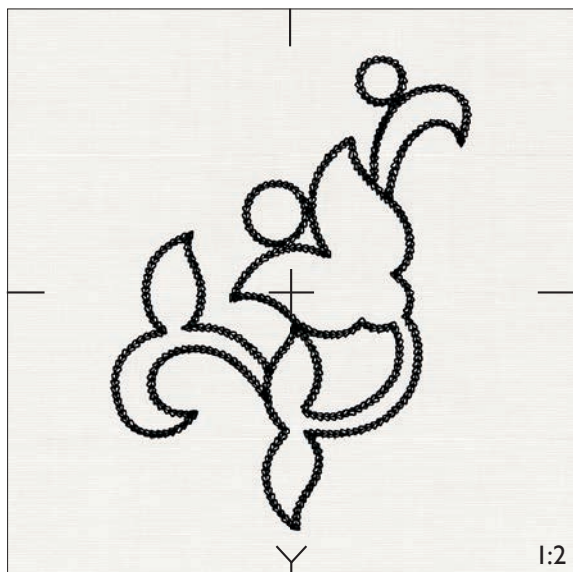

68

Stitches: 1 874  
Height: 96 mm  
Width: 66 mm

1 ■ 1234  
2296

Gütermann Sulky  
Robison - Anton

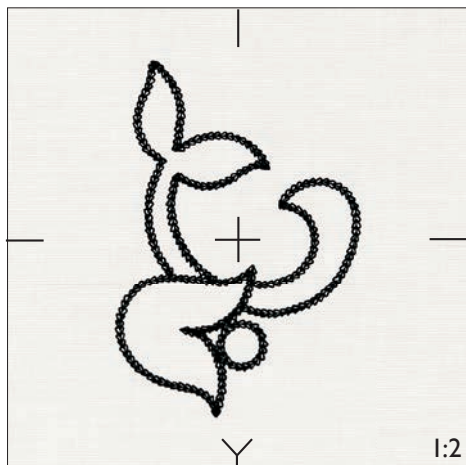

69

Stitches: 1 502  
Height: 71 mm  
Width: 77 mm

1 ■ 1234  
2296

Gütermann Sulky  
Robison - Anton

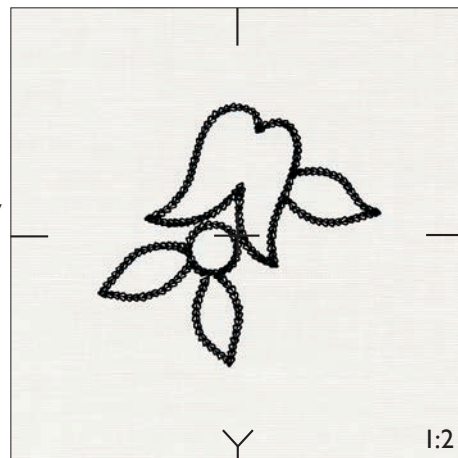

70

Stitches: 1 179  
Height: 64 mm  
Width: 41 mm

1 ■ 1234  
2296

Gütermann Sulky  
Robison - Anton

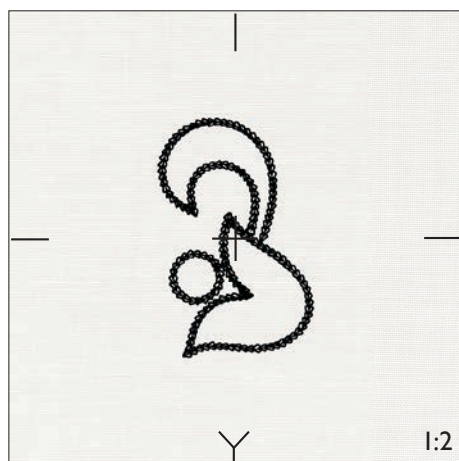

71

Stitches: 1 454  
Height: 68 mm  
Width: 70 mm

1 ■ 1234  
2296

Gütermann Sulky  
Robison - Anton

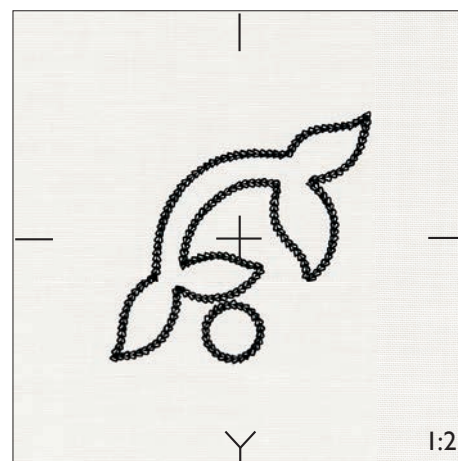



Designs # 72, 73, 74, 75, 76, 77

# 72

Stitches: 4 824  
Height: 50 mm  
Width: 51 mm

- 1  1011  
2618
- 2  1248  
2239
- 3  1096  
2446
- 4  1104  
2547

Gütermann Sulky  
Robison - Anton

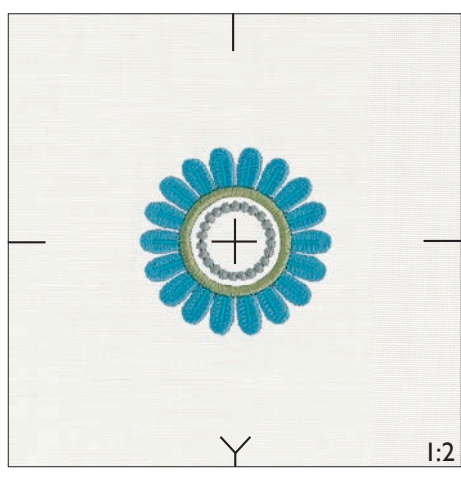

# 73

Stitches: 2 772  
Height: 41 mm  
Width: 47 mm

- 1  1104  
2547
- 2  1248  
2239

Gütermann Sulky  
Robison - Anton

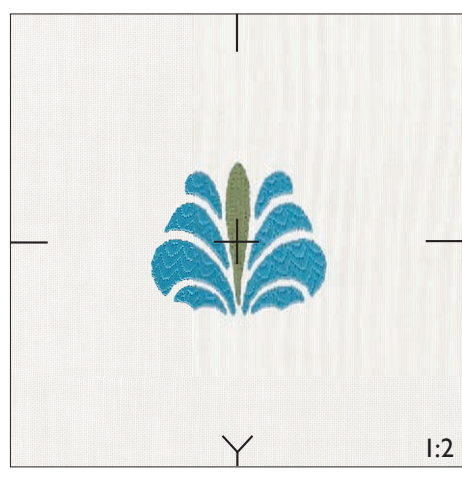

# 74

Stitches: 3 789  
Height: 63 mm  
Width: 44 mm

- 1  1104  
2547
- 2  1248  
2239
- 3  1011  
2618

Gütermann Sulky  
Robison - Anton

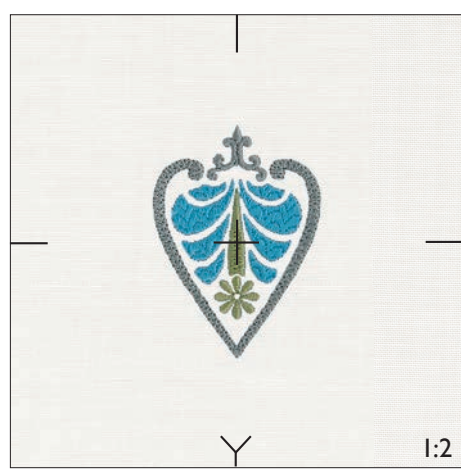

# 75

Stitches: 2 907  
Height: 43 mm  
Width: 86 mm

- 1  1104  
2547
- 2  1011  
2618
- 3  1248  
2239
- 4  1104  
2547

Gütermann Sulky  
Robison - Anton



# 76

Stitches: 1 048  
Height: 40 mm  
Width: 33 mm

- 1  1104  
2547

Gütermann Sulky  
Robison - Anton

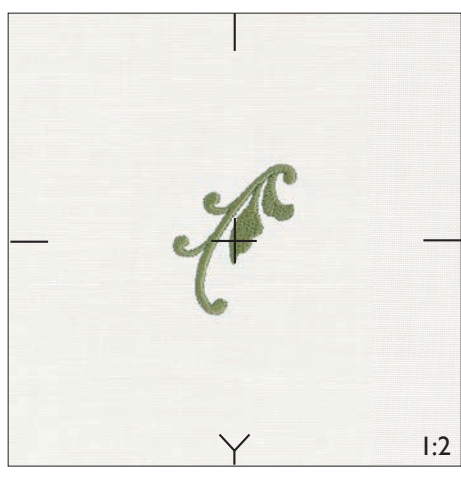

# 77

Stitches: 621  
Height: 43 mm  
Width: 27 mm

- 1  1104  
2547

Gütermann Sulky  
Robison - Anton

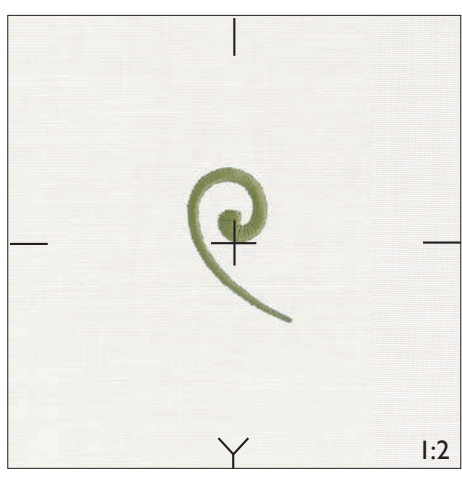



78

Stiches: 20 678  
Höhe: 237 mm  
Breite: 178 mm

- 1  1216  
2205
- 2  1005  
2296

Gütermann Sulky  
Robison - Anton

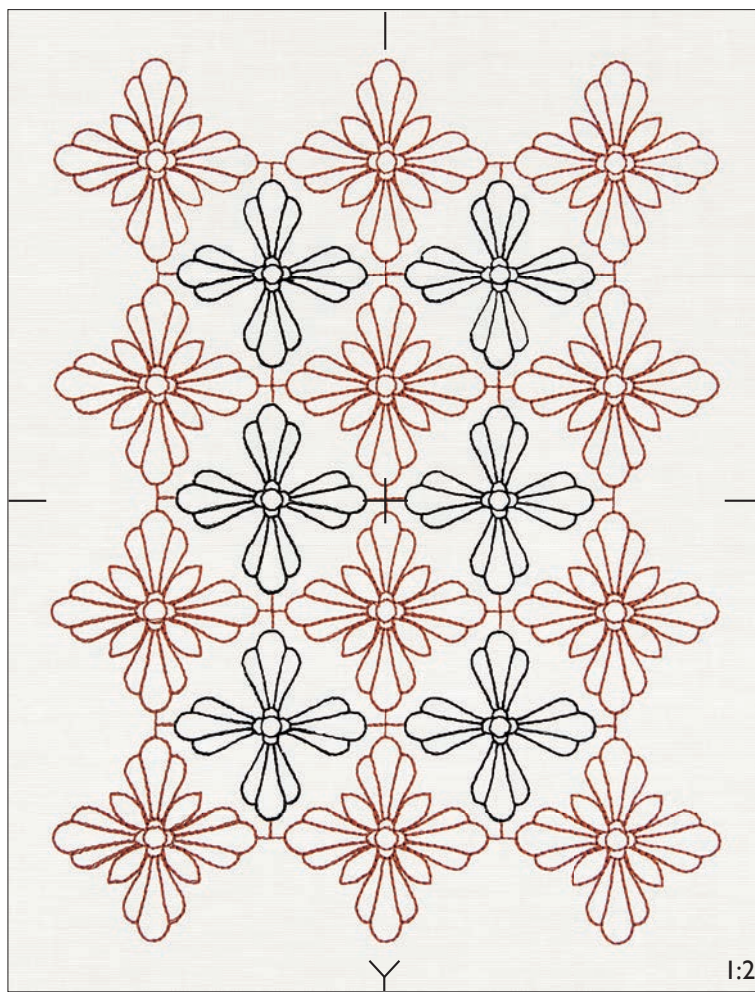

79

Stiches: 1 317  
Höhe: 54 mm  
Breite: 54 mm

- 1  1216  
2205

Gütermann Sulky  
Robison - Anton

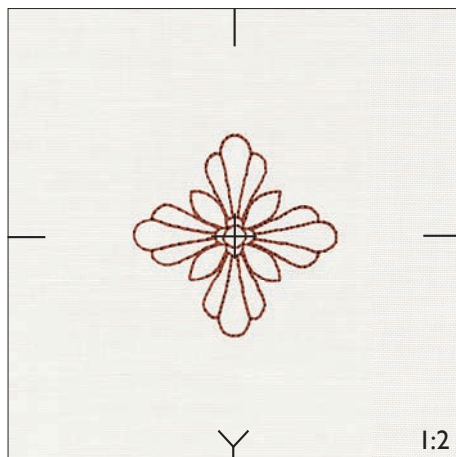

80

Stiches: 994  
Höhe: 51 mm  
Breite: 51 mm

- 1  1005  
2296

Gütermann Sulky  
Robison - Anton

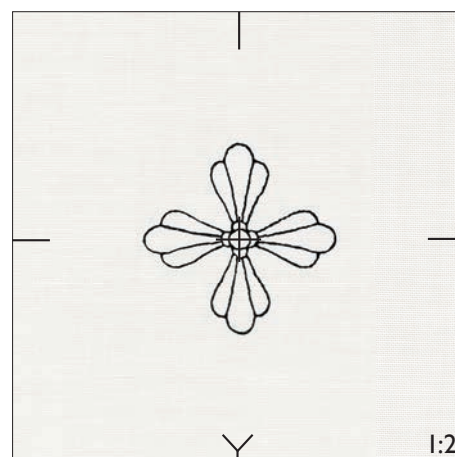

81

Stiches: 15 061  
Height: 239 mm  
Width: 188 mm

1  1169  
2249

Gütermann Sulky  
Robison - Anton

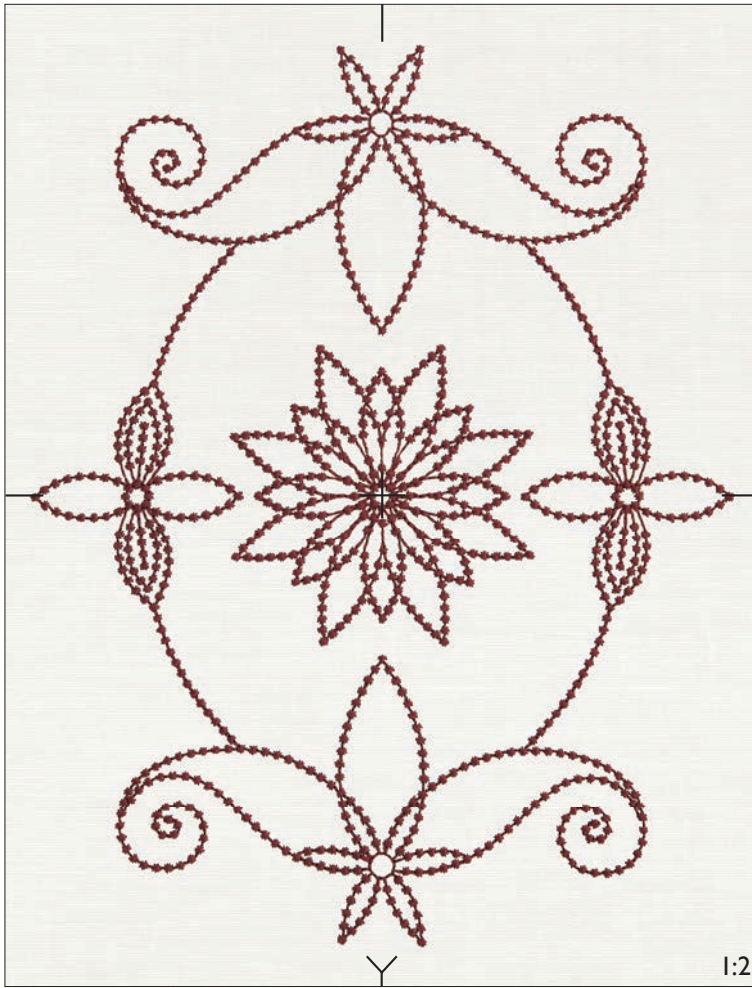

82

Stiches: 6 377  
Height: 111 mm  
Width: 111 mm

1  1169  
2249

Gütermann Sulky  
Robison - Anton

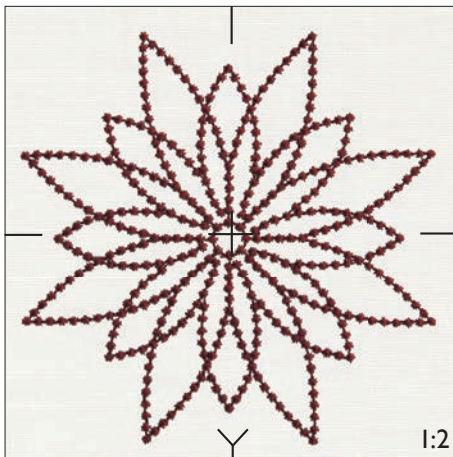

83

Stiches: 5 086  
Height: 114 mm  
Width: 114 mm

1  1169  
2249

Gütermann Sulky  
Robison - Anton

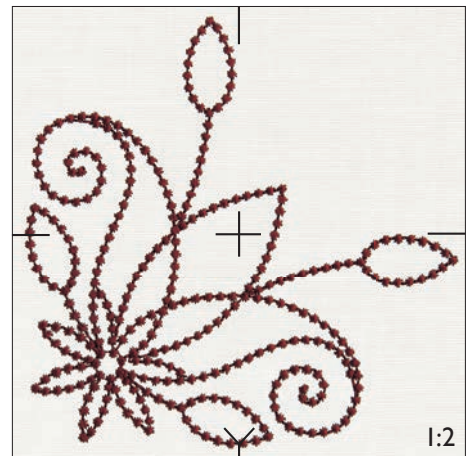

84

Stitches: 22 523  
Height: 207 mm  
Width: 189 mm

1 ■ 1202  
2534

Gütermann Sulky  
Robison - Anton

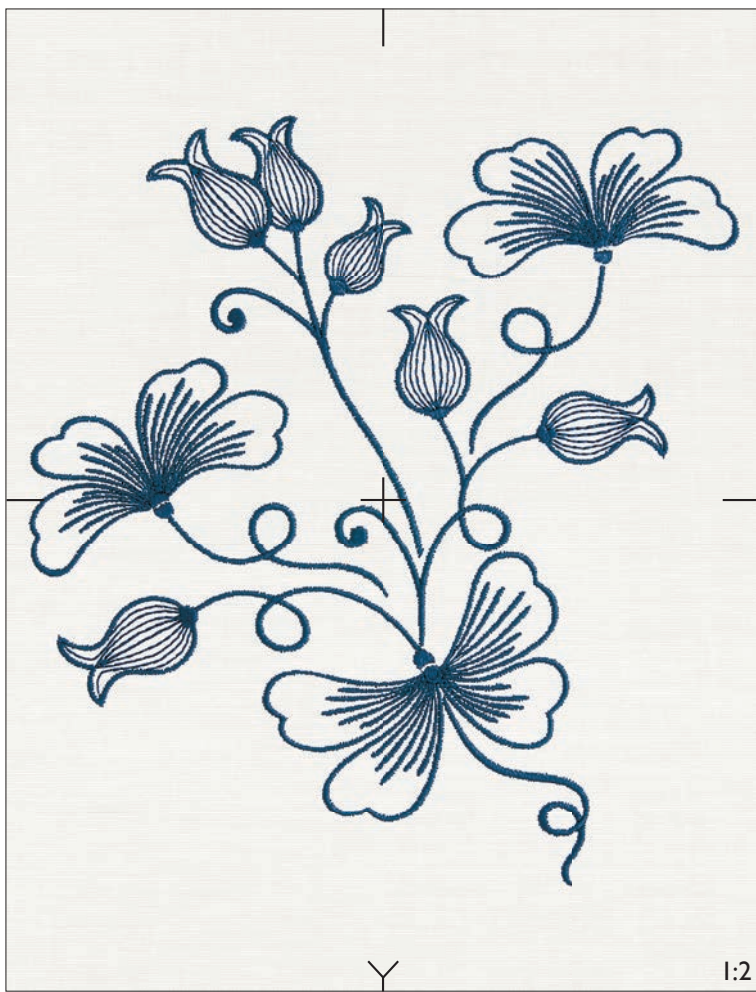

85

Stitches: 9 305  
Height: 109 mm  
Width: 115 mm

1 ■ 1202  
2534

Gütermann Sulky  
Robison - Anton

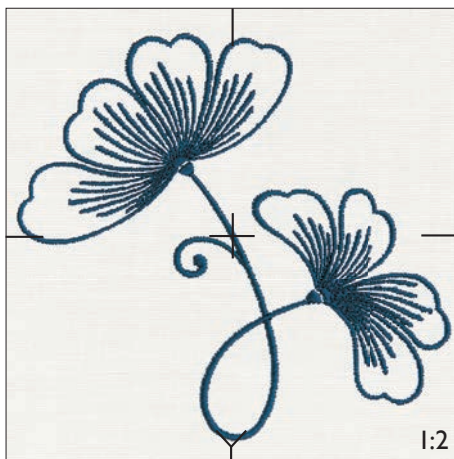

86

Stitches: 5 658  
Height: 109 mm  
Width: 115 mm

1 ■ 1202  
2534

Gütermann Sulky  
Robison - Anton

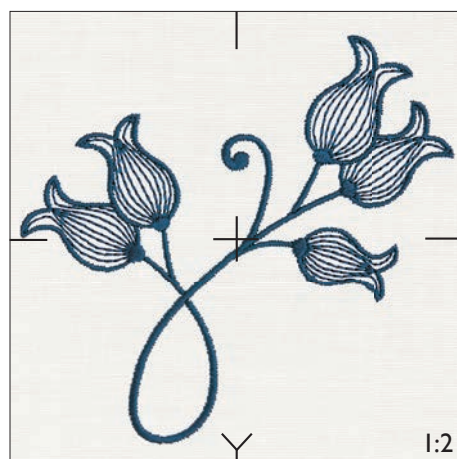

87

Stitches: 9 398  
 Height: 198 mm  
 Width: 137 mm









1  1211  
 2317

Gütermann Sulky  
 Robison - Anton



88

Stitches: 16 515  
 Height: 177 mm  
 Width: 88 mm

1  1111  
 2285  
 2  1254  
 2286  
 3  1212  
 2729  
 4  1297  
 2265  
 5  1167  
 2234  
 6  1080  
 2588  
 7  1031  
 2340  
 8  1193  
 2482  
 9  1111  
 2285

Gütermann Sulky  
 Robison - Anton



# 89

Stitches: 6 025  
 Height: 175 mm  
 Width: 108 mm

1  1165  
 2283

2  1327  
 2539

3  1002  
 2574

4  1120  
 2582

Gütermann Sulky  
 Robison - Anton

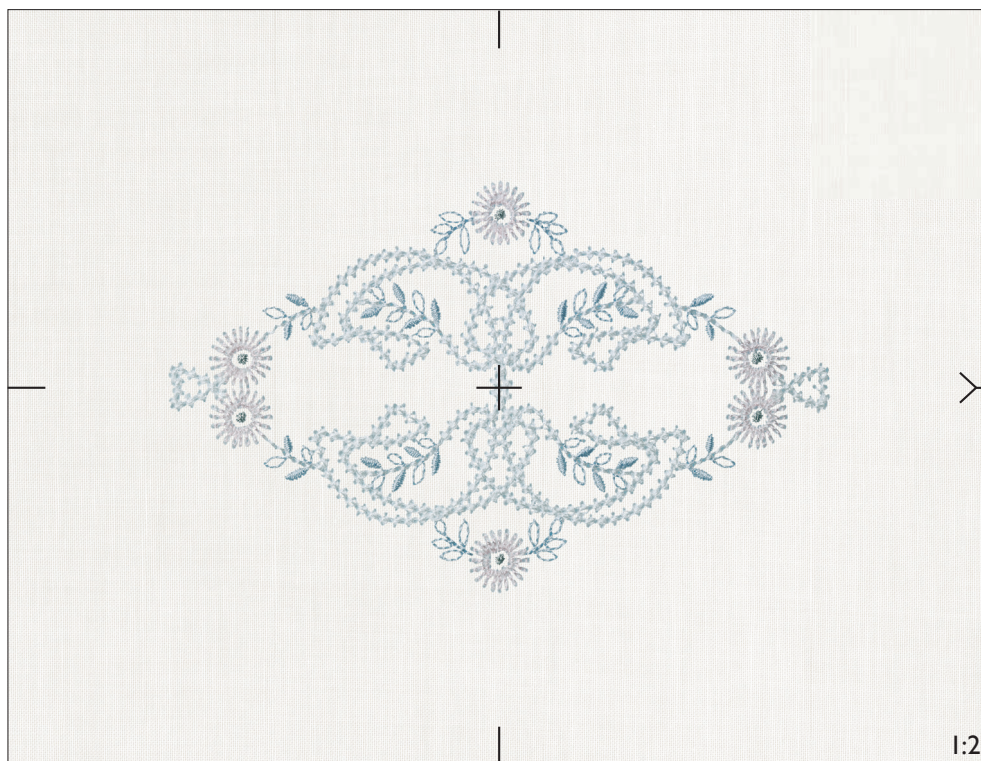

156 Sensational Needle Effects, design #8

# 90

Stitches: 22 839  
 Height: 232 mm  
 Width: 63 mm

1  1070  
 2557

2  1017  
 2413

3  1115  
 2223

4  1061  
 2316

5  1220  
 2217

6  1111  
 2285

7  1201  
 2239

8  1145  
 2269

9  1064  
 2501

10  1205  
 2624

11  1204  
 2238

12  1145  
 2269

13  1193  
 2482

14  1001  
 2343

15  1217  
 2610

16  1193  
 2482

17  1255  
 2628

Gütermann Sulky  
 Robison - Anton

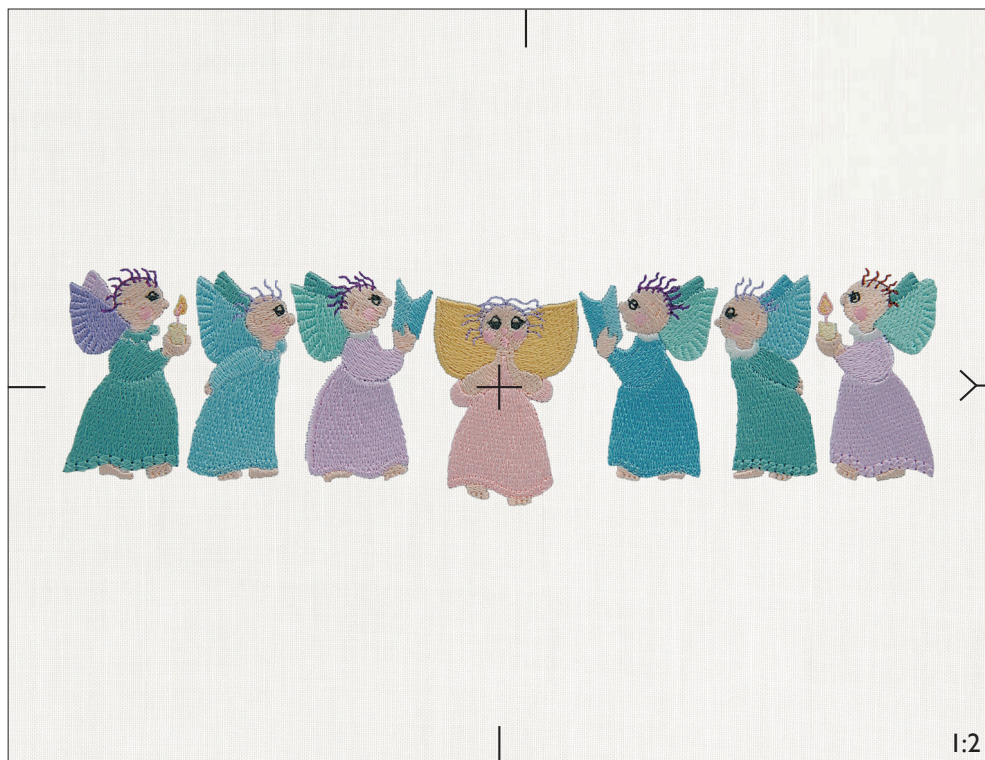

# 91

Stitches: 3 287  
Height: 168 mm  
Width: 53 mm

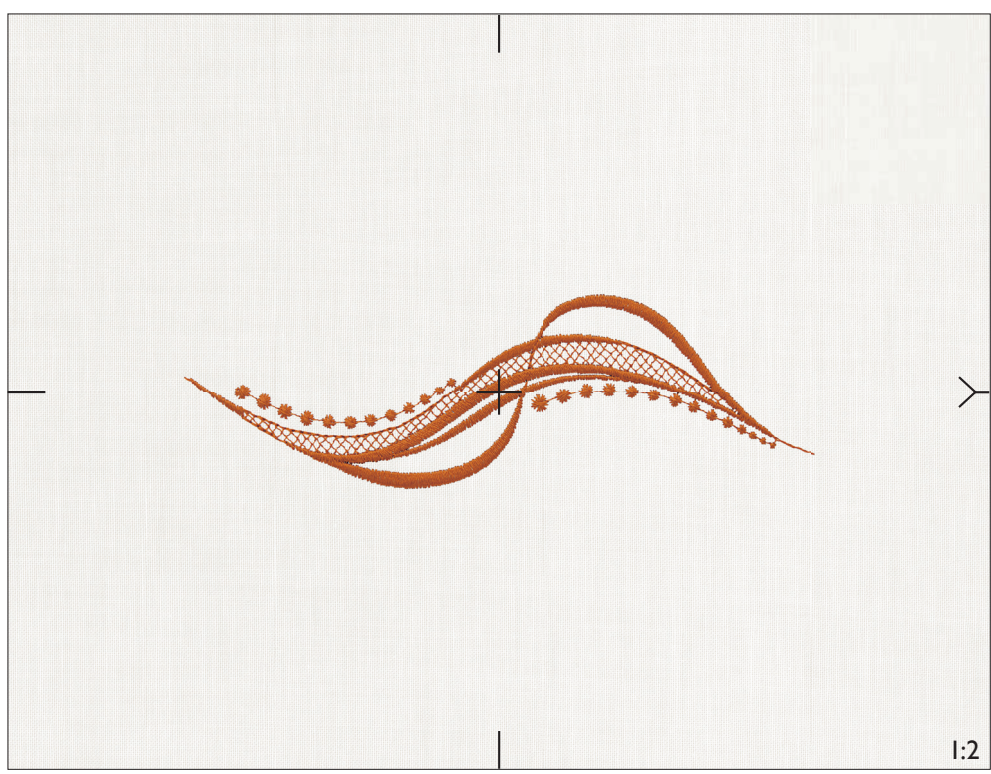

1  1021  
2289

Gütermann Sulky  
Robison - Anton



# 92

Stitches: 4 956  
Height: 193 mm  
Width: 87 mm

1  1021  
2289  
2  1021  
2289

Gütermann Sulky  
Robison - Anton



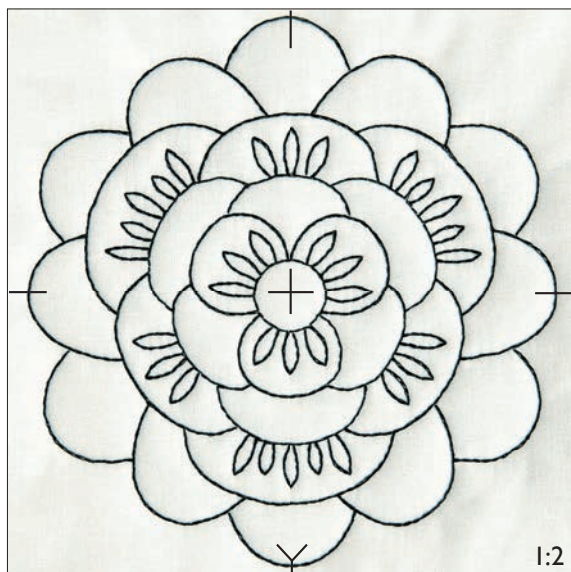

93

Stitches: 3 634  
Height: 145 mm  
Width: 139 mm

1 ■ 1234  
2296

Gütermann Sulky  
Robison - Anton

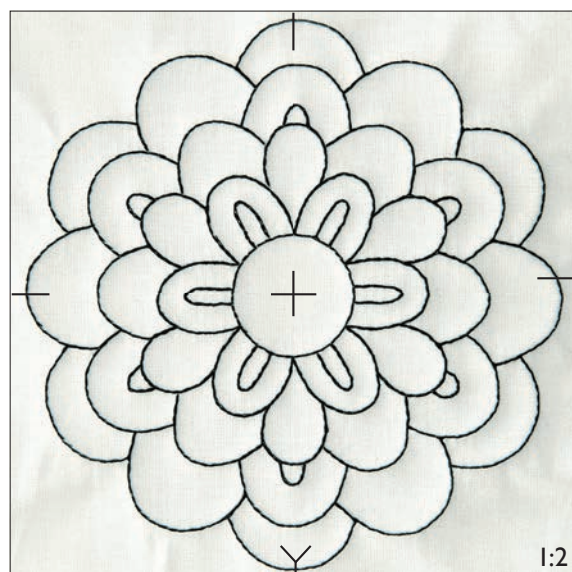

94

Stitches: 2 889  
Height: 145 mm  
Width: 141 mm

1 ■ 1234  
2296

Gütermann Sulky  
Robison - Anton

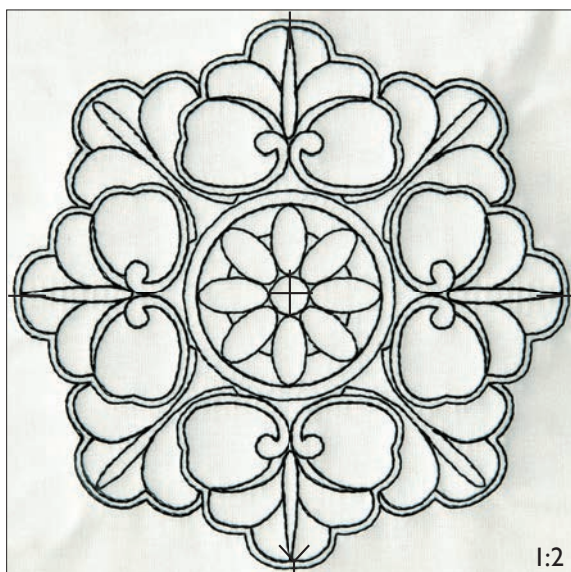

95

Stitches: 6 269  
Height: 145 mm  
Width: 145 mm

1 ■ 1234  
2296

Gütermann Sulky  
Robison - Anton

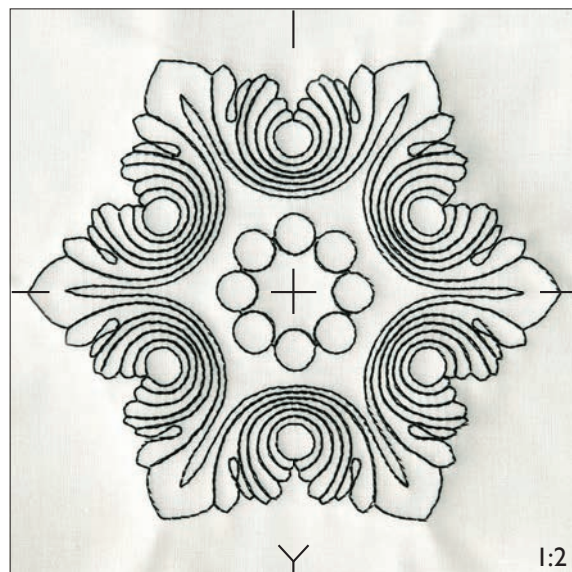

96

Stitches: 6 145  
Height: 126 mm  
Width: 145 mm

1 ■ 1234  
2296

Gütermann Sulky  
Robison - Anton

97

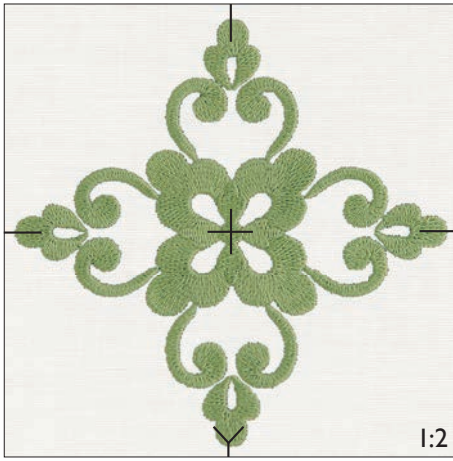

Stitches: 8 563  
Height: 115 mm  
Width: 115 mm

1  1104  
2547

Gütermann Sulky  
Robison - Anton

98

Stitches: 11 510  
Height: 116 mm  
Width: 102 mm

1  1104  
2547

Gütermann Sulky  
Robison - Anton

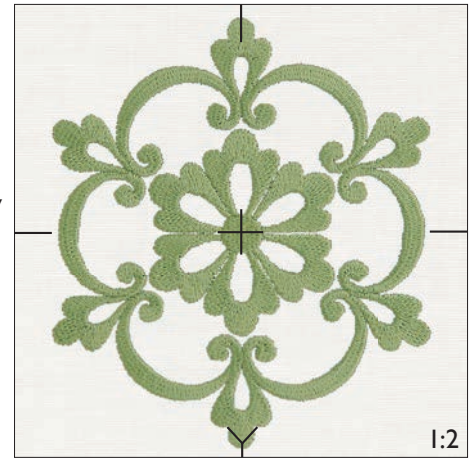

99

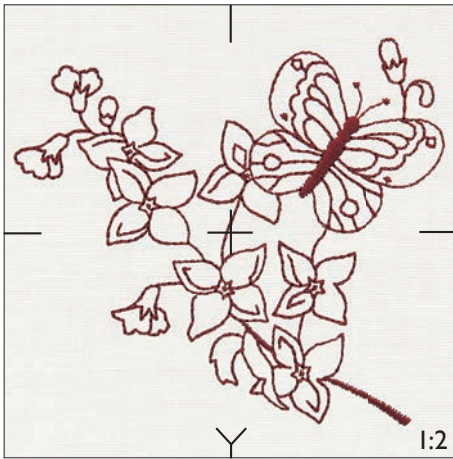

Stitches: 4 574  
Height: 103 mm  
Width: 114 mm

1  1169  
2249

Gütermann Sulky  
Robison - Anton

100

Stitches: 7 364  
Height: 105 mm  
Width: 105 mm

1  1076  
2528

2  1039  
2508

3  1185  
2466

Gütermann Sulky  
Robison - Anton

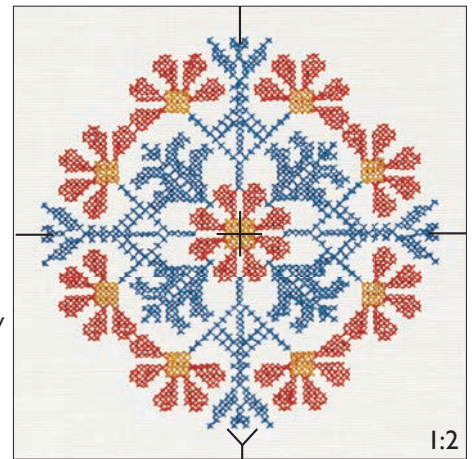

101

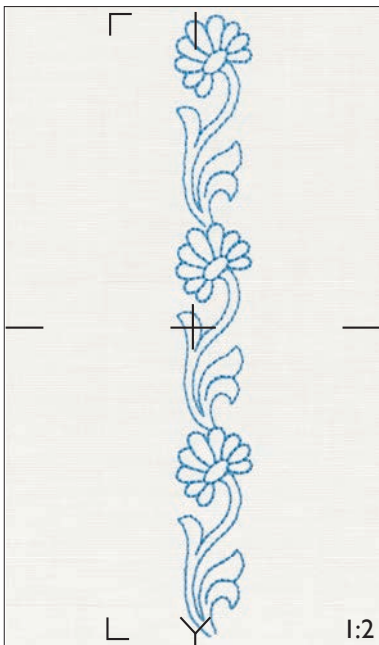

Stitches: 2 003  
Height: 165 mm  
Width: 30 mm

1  1028  
2206

Gütermann Sulky  
Robison - Anton

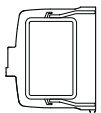

102

Stitches: 4 256  
Height: 159 mm  
Width: 50 mm

1  1076  
2528

Gütermann Sulky  
Robison - Anton

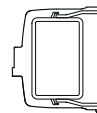
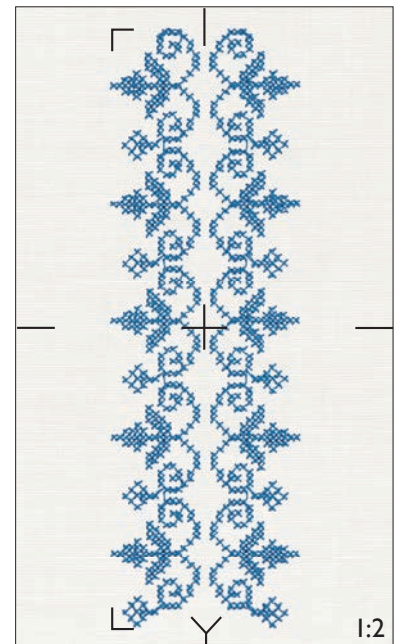



# 103

Stitches: 11 292  
 Height: 166 mm  
 Width: 80 mm

- 1  1169  
2249
- 2  1127  
2476
- 3  1127  
2476
- 4  1127  
2476
- 5  1127  
2476

Gütermann Sulky  
 Robison - Anton

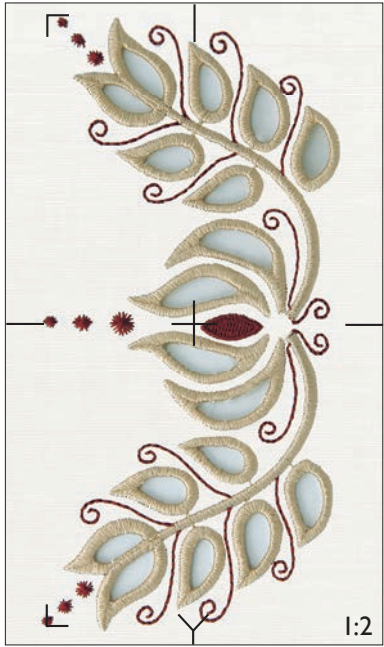

1:2

# 104

Stitches: 3 202  
 Height: 150 mm  
 Width: 18 mm

- 1  1104  
2547
- 2  1248  
2239
- 3  1248  
2239

Gütermann Sulky  
 Robison - Anton

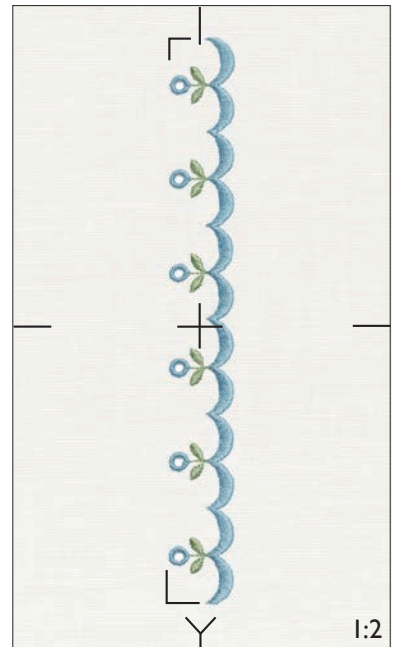
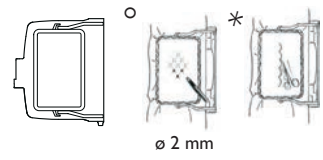

1:2

65 Delicate & Dainty, design #15

# 105

Stitches: 9 129  
 Height: 166 mm  
 Width: 12 mm

- 1  1263  
2263
- 2  1117  
2374
- 3  1238  
2409

Gütermann Sulky  
 Robison - Anton

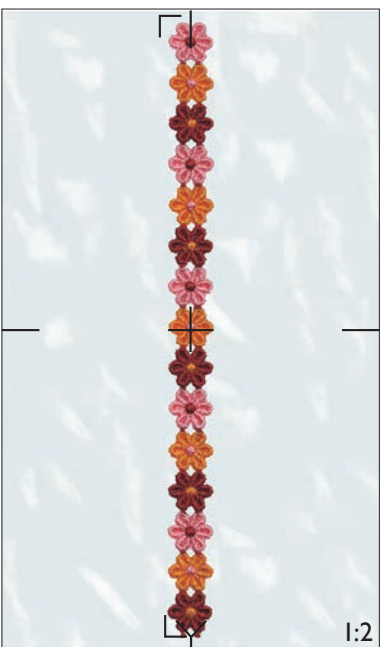

1:2

65 Delicate & Dainty, design #2



# 106

Stitches: 12 751  
 Height: 160 mm  
 Width: 39 mm

- 1  1017  
2413
- Step 1
- 2  1017  
2413
- Step 2
- 3  1017  
2413

Gütermann Sulky  
 Robison - Anton

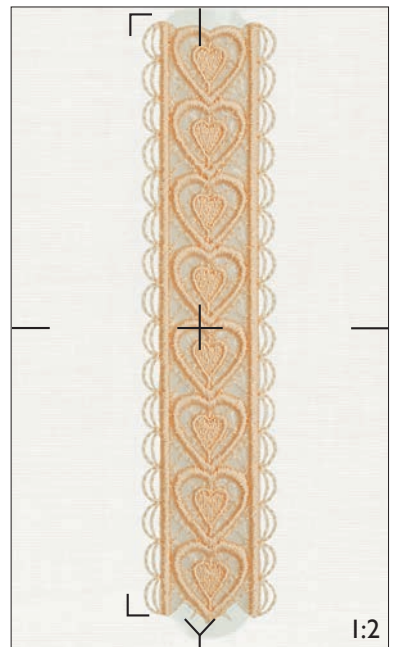

1:2

91 Endless Insertions & Thread Work, design #9

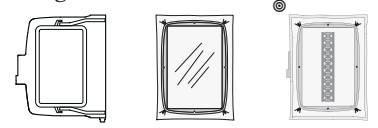

# 107

Stitches: 19 709  
Height: 93 mm  
Width: 96 mm

1  1071  
2574

Gütermann Sulky  
Robison - Anton

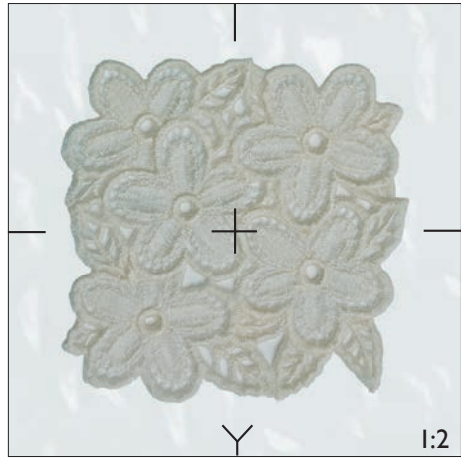



166 Vintage Lace, design #15



# 108

Stitches: 16 878  
Height: 109 mm  
Width: 109 mm





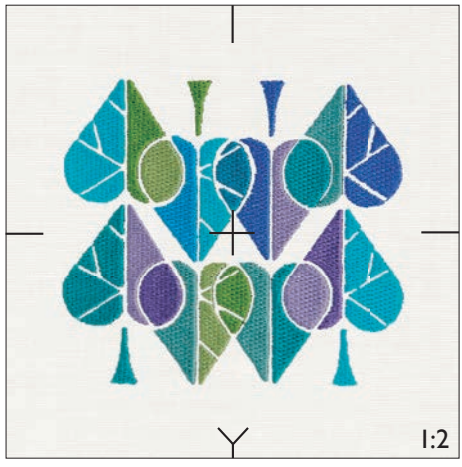
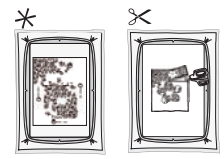
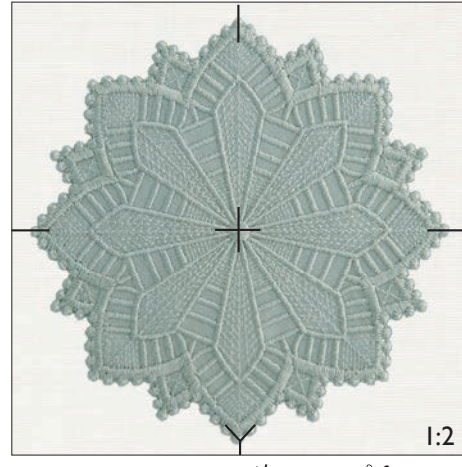





1  1236  
\* 2574  
2  1236  
3  1236  
2574

Gütermann Sulky  
Robison - Anton



# 109

Stitches: 9 241  
Height: 81 mm  
Width: 93 mm





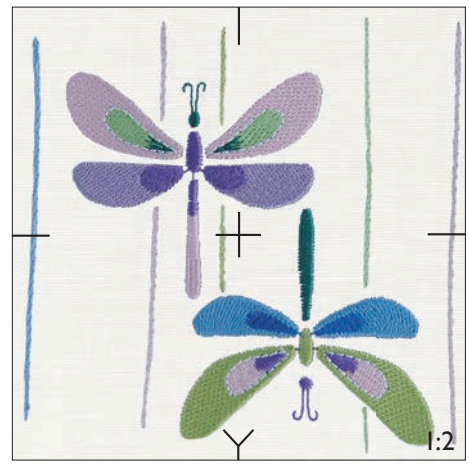



1  1226	6  1095
2  1193	7  1513
3  1194	8  1252
4  1205	9  1104
5  1251	10  1177

Gütermann Sulky  
Robison - Anton



# 110

Stitches: 6 773  
Height: 116 mm  
Width: 115 mm

1  1028	6  1104
2  1076	7  1047
3  1111	8  1517
4  1193	9  1001
5  1194	

Gütermann Sulky  
Robison - Anton

# 111

Stitches: 4 077  
Height: 115 mm  
Width: 111 mm

- 1  1124  
2325
- 2  1104  
2547
- 3  1121  
2599
- 4  1109  
2415
- 5  1533  
2504

Gütermann Sulky  
Robison - Anton

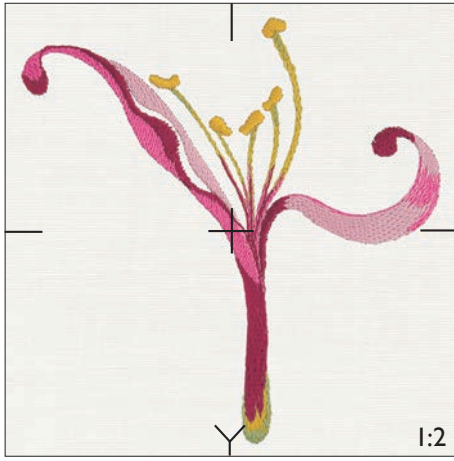

# 112

Stitches: 8 264  
Height: 112 mm  
Width: 101 mm

- 1  1533  
2504
- 2  1037  
2420
- 3  1246  
2467
- 4  1078  
2469
- 5  1184  
2467
- 6  1065  
2465
- 7  1177  
2457

Gütermann Sulky  
Robison - Anton

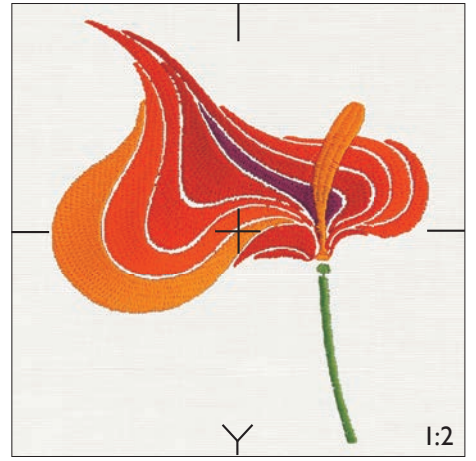

# 113

Stitches: 10 203  
Height: 97 mm  
Width: 111 mm

- 1  1111  
2285
- 2  1031  
2340
- 3  1002  
2343
- 4  1194  
2288
- 5  1176  
2595
- 6  1177  
2457
- 7  1002  
2574

Gütermann Sulky  
Robison - Anton

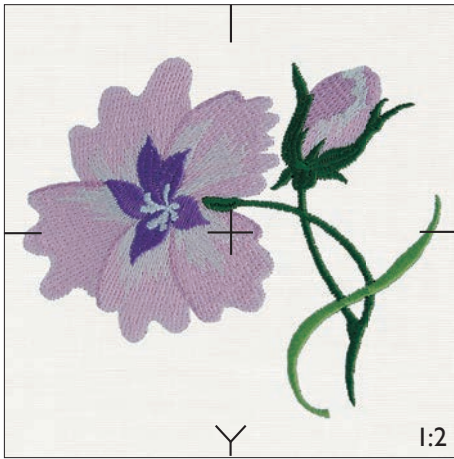

# 114

Stitches: 11 512  
Height: 98 mm  
Width: 106 mm

- 1  1104  
2547
- 2  1177  
2457
- 3  1002  
2574
- 4  1117  
2276
- 5  1119  
2591
- 6  1165  
2283
- 7  1023  
2560

Gütermann Sulky  
Robison - Anton

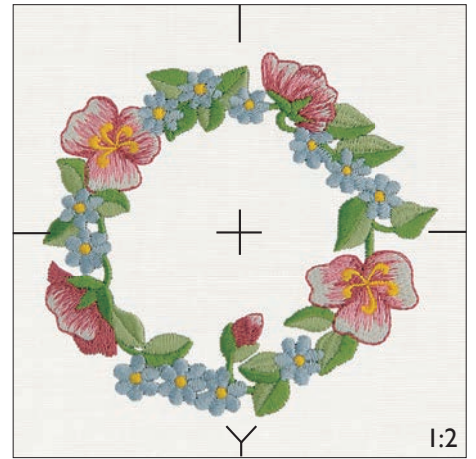

# 115

Stitches: 10 763  
Height: 106 mm  
Width: 114 mm

- 1  1001  
2343
- 2  1167  
2234
- 3  1227  
2546
- 4  1056  
2569

Gütermann Sulky  
Robison - Anton



# 116

Stitches: 10 103  
Height: 112 mm  
Width: 112 mm

- 1  1104  
2547
- 2  1064  
2377
- 3  1016  
2374



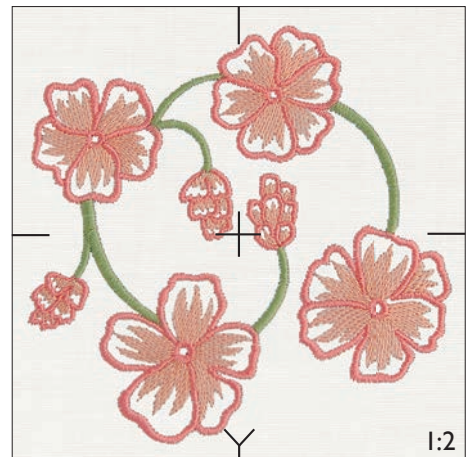

Gütermann Sulky  
Robison - Anton

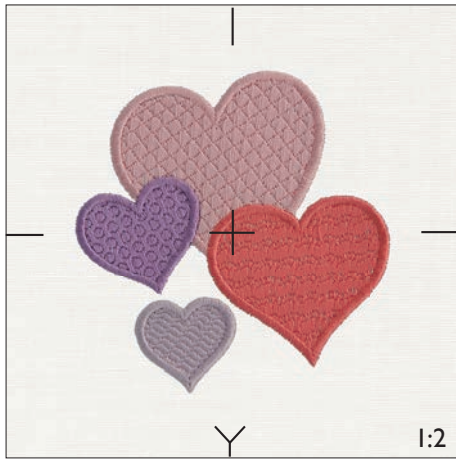

# 117





Stitches: 10 193  
Height: 88 mm  
Width: 84 mm

- 1  1115  
2223
- 2  1154  
2412
- 3  1080  
2588
- 4  1111  
2285

Gütermann Sulky  
Robison - Anton

# 118

Stitches: 6 648  
Height: 104 mm  
Width: 98 mm

- 1  2102  
2262
- 2  1137  
2331

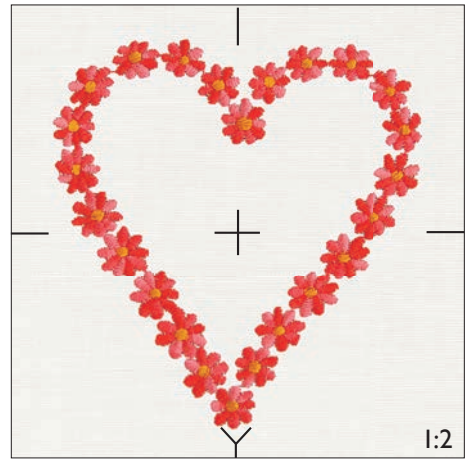

Gütermann Sulky  
Robison - Anton

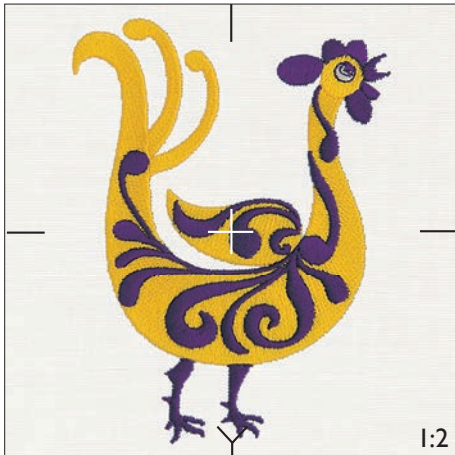

# 119







Stitches: 12 525  
Height: 115 mm  
Width: 85 mm

- 1  1023  
2560
- 2  1071  
2574
- 3  1255  
2628

Gütermann Sulky  
Robison - Anton

# 120

Stitches: 4 793  
Height: 80 mm  
Width: 59 mm

- 1  1177  
2457
- 2  1176  
2595
- 3  1023  
2560
- 4  1137  
2331

Gütermann Sulky  
Robison - Anton

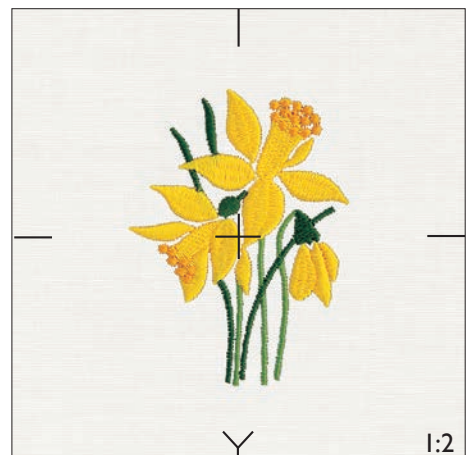

# 121

Stitches: 4 013  
Height: 154 mm  
Width: 62 mm

- 1  1234  
2296



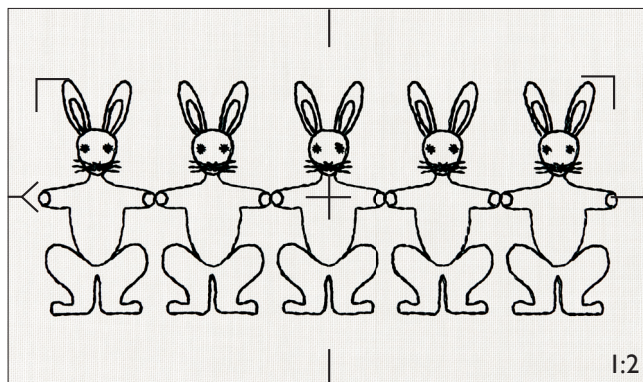
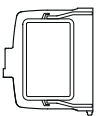

Gütermann Sulky  
Robison - Anton



1:2

# 122

Stitches: 8 819  
Height: 165 mm  
Width: 40 mm

- 1  1137  
2331
- 2  1195  
2428
- 3  1039  
2508
- 4  1207  
2278
- 5  1232  
2315



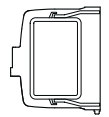
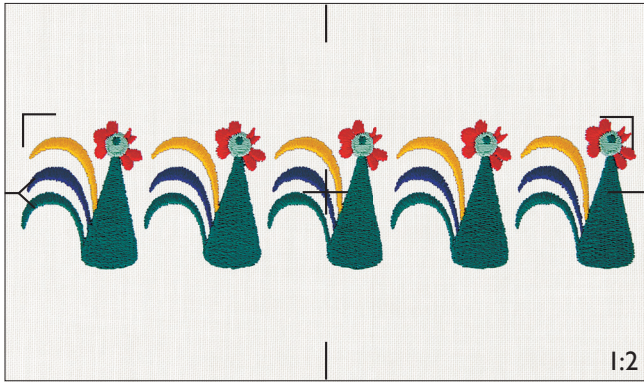

Gütermann Sulky  
Robison - Anton



1:2

# 123

Stitches: 7 459  
Height: 62 mm  
Width: 80 mm

- 1  1238  
2409
- 2  1169  
2249
- 3  1228  
2477
- 4  1104  
2547
- 5  1049  
2214



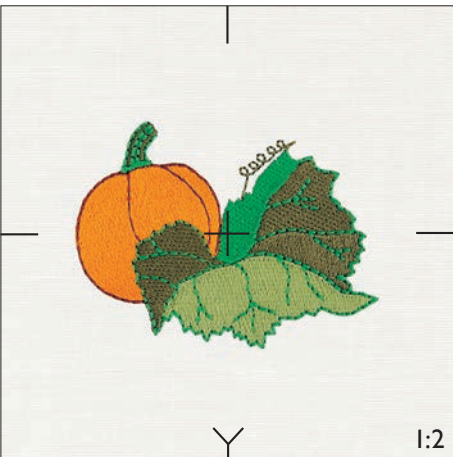

Gütermann Sulky  
Robison - Anton



1:2

# 124

Stitches: 2 656  
Height: 76 mm  
Width: 72 mm

- 1  1234  
2296
- 2  1011  
2618
- 3  7011  
2231
- 4  1021  
2289

Gütermann Sulky  
Robison - Anton



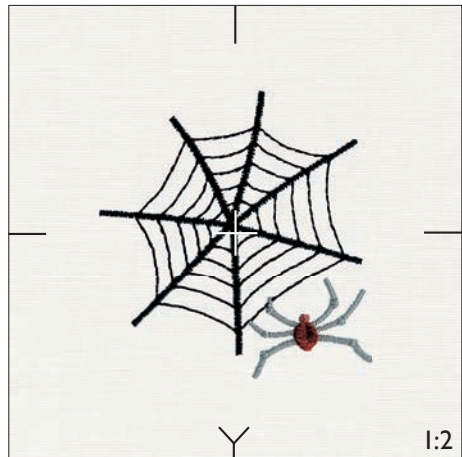

Thread Velvet™



1:2

# 125

Stitches: 7 621  
Height: 106 mm  
Width: 111 mm

- 1  1168  
2328
- 2  1059  
2576
- 3  1147  
2263
- 4  1185  
2466
- 5  1101  
2390



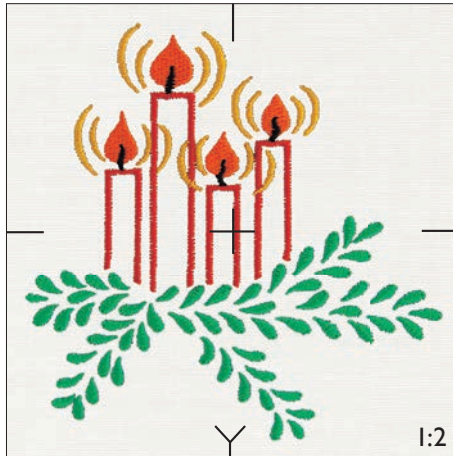

Gütermann Sulky  
Robison - Anton



1:2

# 126

Stitches: 10 871  
Height: 110 mm  
Width: 111 mm

- 1  1232  
2315
- 2  1147  
2263
- 3  1025  
2400
- 4  1011  
2618

Gütermann Sulky  
Robison - Anton

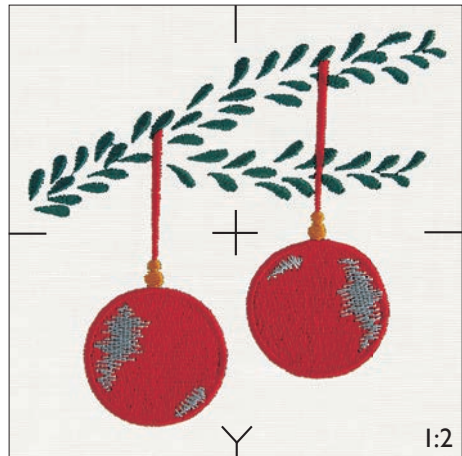

1:2

# 127

Stiches: 9 832  
Height: 102 mm  
Width: 110 mm



- |   |  |      |      |    |  |      |      |                                    |  |      |      |
|---|--|------|------|----|--|------|------|------------------------------------|--|------|------|
| 1 |  | 1001 | 2343 | 6  |  | 1001 | 2343 | 11                                 |  | 1005 | 2296 |
| 2 |  | 1011 | 2618 | 7  |  | 1005 | 2296 | 12                                 |  | 1238 | 2409 |
| 3 |  | 1025 | 2400 | 8  |  | 1049 | 2214 | 13                                 |  | 1147 | 2263 |
| 4 |  | 1001 | 2343 | 9  |  | 1005 | 2296 | Gütermann Sulky<br>Robison - Anton |  |      |      |
| * |  | 1001 | 2343 | 10 |  | 1220 | 2217 |                                    |  |      |      |

# 128

Stiches: 9 400  
Height: 116 mm  
Width: 97 mm

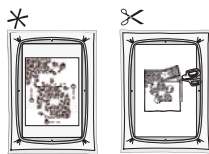

- |   |  |      |      |    |  |      |      |                                    |  |      |      |
|---|--|------|------|----|--|------|------|------------------------------------|--|------|------|
| 1 |  | 1165 | 2283 | 6  |  | 1028 | 2206 | 11                                 |  | 1017 | 2413 |
| * |  | 1165 | 2283 | 7  |  | 1028 | 2206 | 12                                 |  | 1130 | 2563 |
| 2 |  | 1165 | 2283 | 8  |  | 1196 | 2433 | 13                                 |  | 1025 | 2400 |
| 3 |  | 1165 | 2283 | 9  |  | 1037 | 2420 | Gütermann Sulky<br>Robison - Anton |  |      |      |
| 4 |  | 1017 | 2413 | 10 |  | 1016 | 2374 |                                    |  |      |      |
| 5 |  | 1028 | 2206 |    |  |      |      |                                    |  |      |      |
| * |  |      |      |    |  |      |      |                                    |  |      |      |

# 129

Stiches: 13 701  
Height: 102 mm  
Width: 114 mm



- |   |  |      |      |    |  |      |      |                                    |  |      |      |
|---|--|------|------|----|--|------|------|------------------------------------|--|------|------|
| 1 |  | 1059 | 2576 | 6  |  | 1017 | 2413 | 11                                 |  | 1025 | 2400 |
| 2 |  | 1147 | 2263 | 7  |  | 1001 | 2343 | 12                                 |  | 1147 | 2263 |
| 3 |  | 1503 | 2514 | 8  |  | 1128 | 2273 | 13                                 |  | 1001 | 2343 |
| 4 |  | 1025 | 2400 | 9  |  | 1070 | 2557 | 14                                 |  | 1166 | 2265 |
| 5 |  | 1147 | 2263 | 10 |  | 1166 | 2265 | Gütermann Sulky<br>Robison - Anton |  |      |      |

# 130



Stiches: 14 435  
Height: 110 mm  
Width: 114 mm



- |   |  |      |      |   |  |      |      |                                    |  |      |      |
|---|--|------|------|---|--|------|------|------------------------------------|--|------|------|
| 1 |  | 1128 | 2273 | 5 |  | 1166 | 2265 | 9                                  |  | 1166 | 2265 |
| 2 |  | 1170 | 2402 | 6 |  | 1147 | 2263 | 10                                 |  | 1170 | 2402 |
| 3 |  | 1001 | 2343 | 7 |  | 1017 | 2413 | 11                                 |  | 1025 | 2400 |
| 4 |  | 1147 | 2263 | 8 |  | 1001 | 2343 | Gütermann Sulky<br>Robison - Anton |  |      |      |

# 131

Stitches: 4 128  
Height: 45 mm  
Width: 66 mm

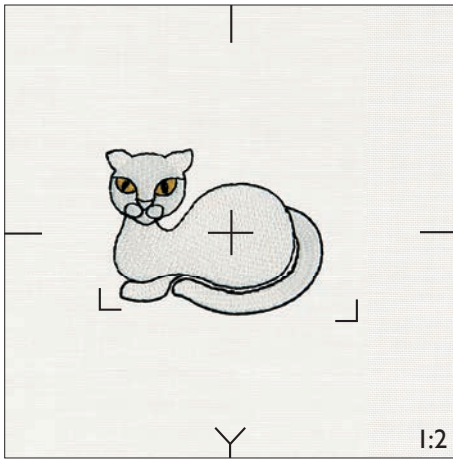

- 1  1001  
2343
- 2  1227  
2562
- 3  1005  
2296

Gütermann Sulky  
Robison - Anton



# 132

Stitches: 5 695  
Height: 45 mm  
Width: 67 mm



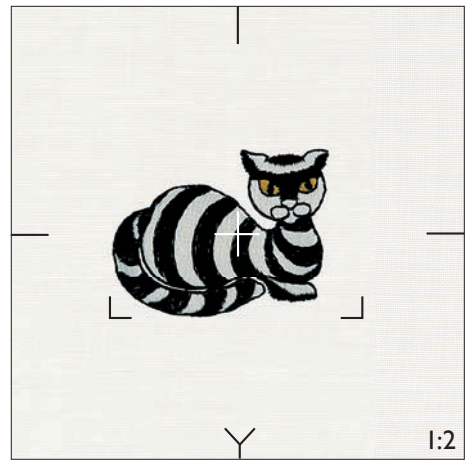

- 1  1001  
2343
- 2  1227  
2562
- 3  1005  
2296

Gütermann Sulky  
Robison - Anton



# 133

Stitches: 4 440  
Height: 45 mm  
Width: 58 mm

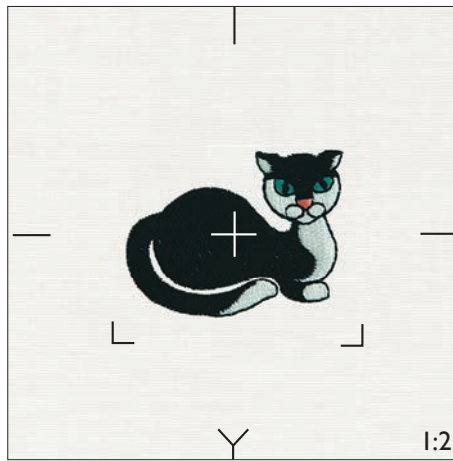

- 1  1001  
2343
- 2  1513  
2446
- 3  1020  
2414
- 4  1005  
2296

Gütermann Sulky  
Robison - Anton



# 134

Stitches: 4 981  
Height: 89 mm  
Width: 64 mm





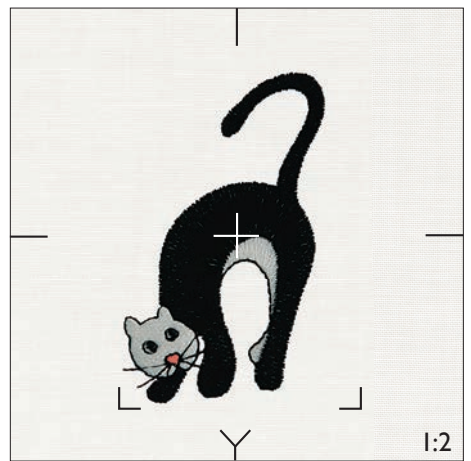





- 1  1001  
2343
- 2  1020  
2414
- 3  1005  
2296

Gütermann Sulky  
Robison - Anton



# 135

Stitches: 8 992  
Height: 91 mm  
Width: 96 mm

- 1  1001  
2343
- 2  1166  
2265
- 3  1219  
2484
- 4  1220  
2217
- 5  1219  
2484
- 6  1127  
2476
- 7  1055  
2234
- 8  1127  
2476
- 9  1216  
2205
- 10  1227  
2562

Gütermann Sulky  
Robison - Anton

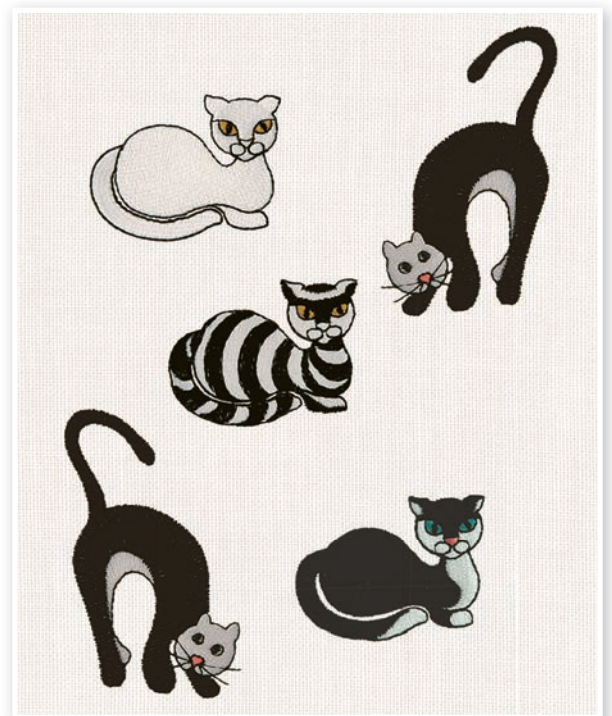
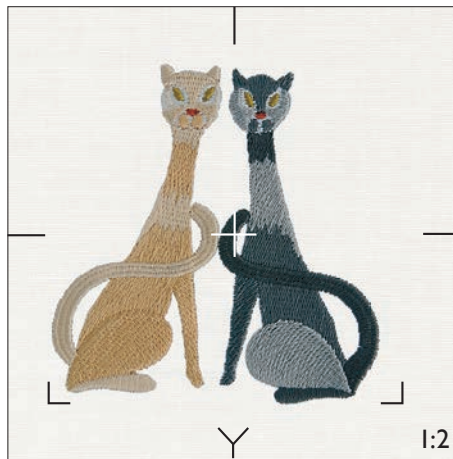

# 136



Stitches: 2 431  
Height: 115 mm  
Width: 108 mm

1 ■ 1234  
2296

Gütermann Sulky  
Robison - Anton

1:2

# 137

Stitches: 1 237  
Height: 110 mm  
Width: 62 mm

1 ■ 1234  
2296

Gütermann Sulky  
Robison - Anton

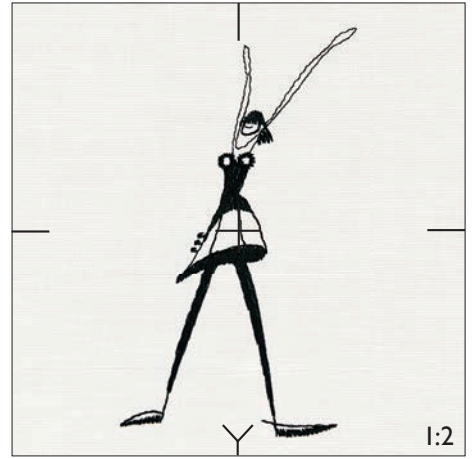

1:2

# 138

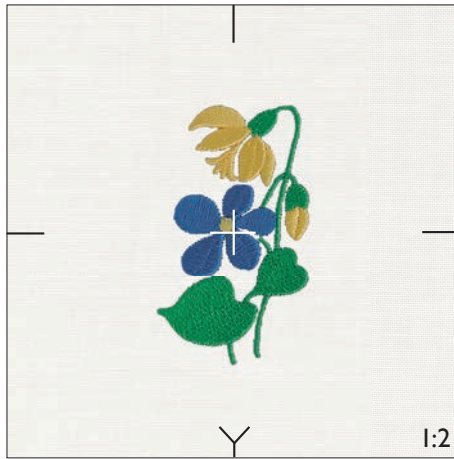

Stitches: 3 516  
Height: 70 mm  
Width: 41 mm

1 ■ 1049  
2214

2 ■ 1226  
2614

3 ■ 1135  
2234

Gütermann Sulky  
Robison - Anton

1:2

# 139

Stitches: 6 855  
Height: 84 mm  
Width: 59 mm

1 ■ 1001  
2343

2 ■ 1017  
2413

3 ■ 1135  
2234

4 ■ 1239  
2394

5 ■ 1037  
2420

6 ■ 1154  
2412

7 ■ 1220  
2217

8 ■ 1224  
2237

9 ■ 1191  
2590

10 ■ 1196  
2433

11 ■ 1177  
2457

Gütermann Sulky  
Robison - Anton

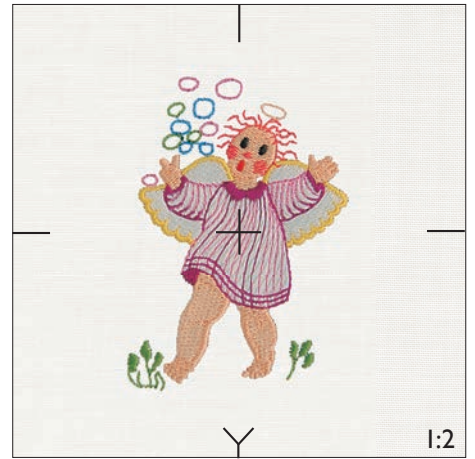

1:2

# 140

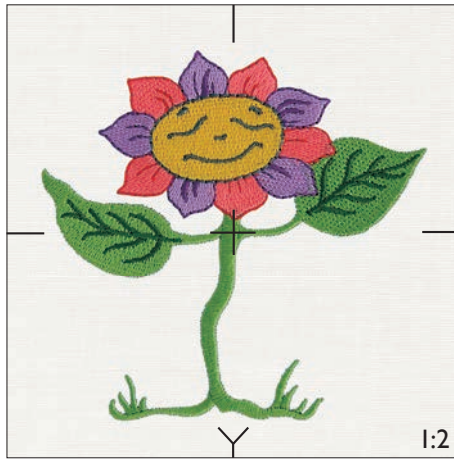

Stitches: 10 013  
Height: 100 mm  
Width: 101 mm

1 ■ 1177  
2457

2 ■ 1176  
2595

3 ■ 1154  
2412

4 ■ 1147  
2263

5 ■ 1080  
2588

6 ■ 1255  
2628

7 ■ 1023  
2561

8 ■ 1041  
2407

Gütermann Sulky  
Robison - Anton

1:2

# 141

Stitches: 20 029  
Height: 100 mm  
Width: 90 mm

1 ■ 1198  
2275

2 ■ 1028  
2206

3 ■ 1251  
2730

4 ■ 1190  
2611

5 ■ 1001  
2343

6 ■ 1135  
2234

7 ■ 1251  
2730

8 ■ 1190  
2611

9 ■ 1237  
2608

10 ■ 1049  
2214

11 ■ 1220  
2217

12 ■ 1028  
2206

13 ■ 1076  
2528

14 ■ 1135  
2234

15 ■ 1190  
2611

16 ■ 1237  
2608

17 ■ 1028  
2206

18 ■ 1251  
2730

Gütermann Sulky  
Robison - Anton

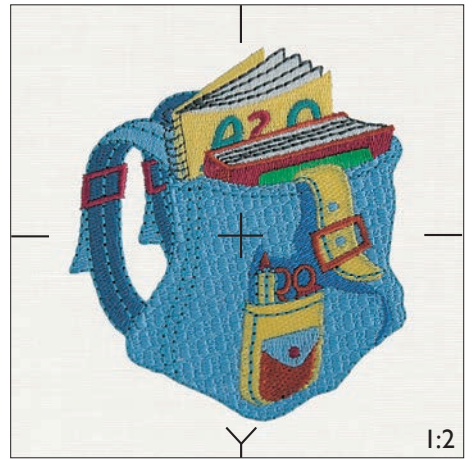

1:2



# 142

Stitches: 14 956  
Height: 99 mm  
Width: 109 mm

- 1  1047  
2238
- 2  1120  
2582
- 3  1121  
2599
- 4  1047  
2238
- 5  1117  
2374
- 6  1025  
2400
- 7  1080  
2588
- 8  1135  
2234
- 9  1056  
2569

Gütermann Sulky  
Robison - Anton

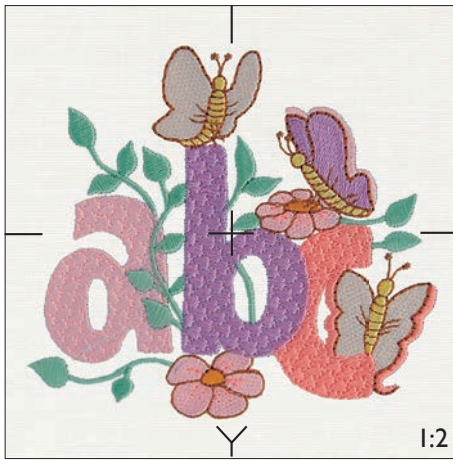

# 143

Stitches: 14 301  
Height: 74 mm  
Width: 109 mm

- 1  1228  
2477
- 2  1212  
2729
- 3  1149  
2593
- 4  1128  
2273
- 5  1170  
2402
- 6  1011  
2618
- 7  1220  
2217
- 8  1071  
2574

Gütermann Sulky  
Robison - Anton

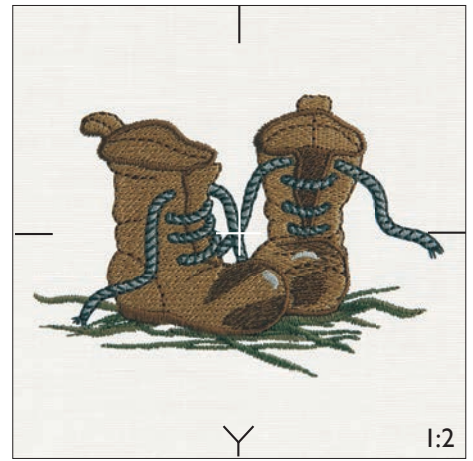

# 144

Stitches: 15 919  
Height: 98 mm  
Width: 106 mm

- 1  1225  
2599
- 2  1117  
2276
- 3  1119  
2591
- 4  1167  
2234
- 5  1001  
2343
- 6  1137  
2331
- 7  1056  
2569

Gütermann Sulky  
Robison - Anton



# 145

Stitches: 6 628  
Height: 62 mm  
Width: 83 mm

- 1  1045  
2310
- 2  1046  
2393
- 3  1030  
2598
- 4  1095  
2307
- 5  1090  
2446
- 6  1226  
2614
- 7  1298  
2407
- 8  1193  
2482
- 9  1137  
2331
- 10  1235  
2428
- 11  1234  
2296

Gütermann Sulky  
Robison - Anton

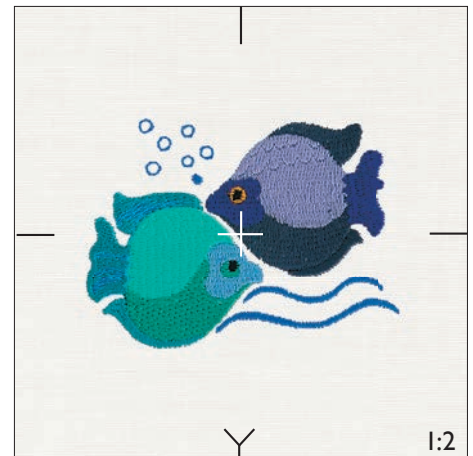

# 146

Stitches: 7 735  
Height: 86 mm  
Width: 69 mm

- 1  1201  
2239
- 2  1510  
2211
- 3  1049  
2214
- 4  1041  
2407

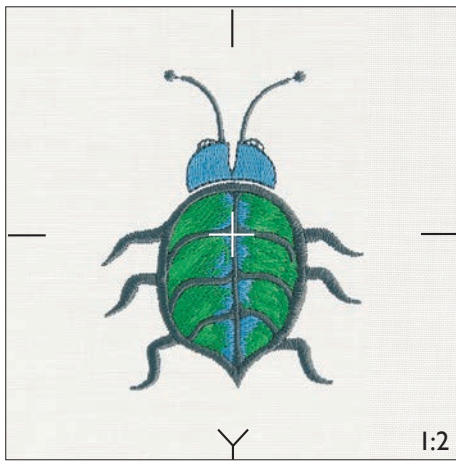

Gütermann Sulky  
Robison - Anton

# 147

Stitches: 4 419  
Height: 71 mm  
Width: 43 mm

- 1  1177  
2738
- 2  1051  
2580
- 3  1248  
2388
- 4  1002  
2343
- 5  1067  
2316
- 6  1124  
2235
- 7  1039  
2467
- 8  1005  
2215

Gütermann Sulky  
Robison - Anton

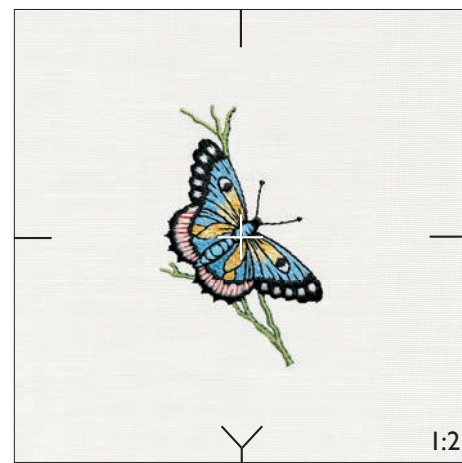

47 Butterflies, design #17

# 148

Stitches: 855  
Height: 64 mm  
Width: 67 mm

- 1  1234  
2296
- \*  1234  
2296
- 2  1234  
2296
- 3  1234  
2296

Gütermann Sulky  
Robison - Anton

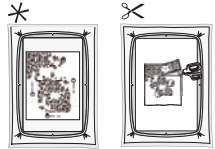
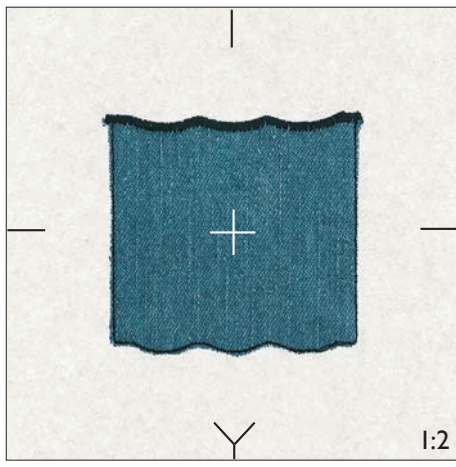

# 149

Stitches: 6 213  
Height: 100 mm  
Width: 68 mm

- 1  1011  
2618
- 2  1076  
2528
- 3  1025  
2400
- 4  1082  
2232
- 5  1159  
2400
- 6  1127  
2476
- 7  1167  
2234
- 8  1234  
2296
- 9  1234  
2296
- \*  1234  
2296
- 10  1234  
2296
- 11  1011  
2618
- 12  1025  
2400

Gütermann Sulky  
Robison - Anton

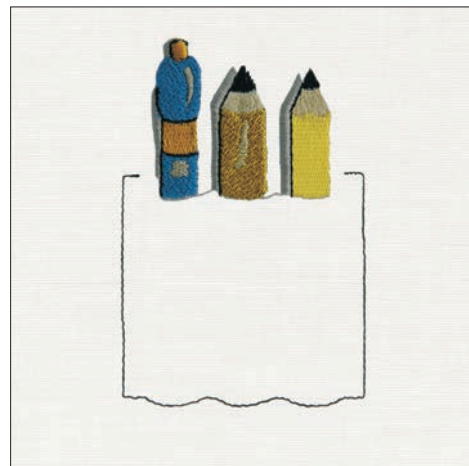
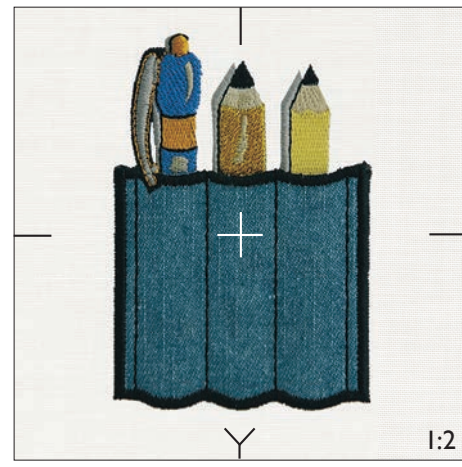

- Step 1
- 1  1011  
2618
  - 2  1076  
2528
  - 3  1025  
2400
  - 4  1082  
2232
  - 5  1159  
2400
  - 6  1127  
2476
  - 7  1167  
2234
  - 8  1234  
2296
  - 9  1234  
2296

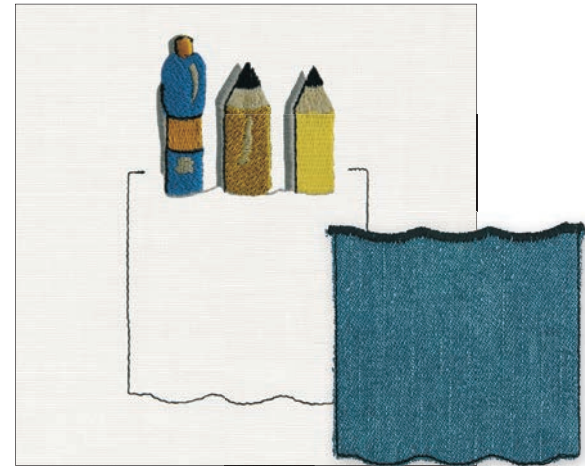

- Step 2
- 10  1234  
2296
  - 11  1011  
2618
  - 12  1025  
2400
- Gütermann Sulky  
Robison - Anton

# 150

Stitches: 524  
Height: 29 mm  
Width: 17 mm

- 1  1056  
2227
- \* 2  1056  
2227
- 3  1056  
2227

Gütermann Sulky  
Robison - Anton

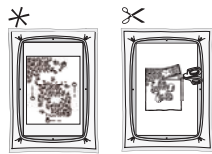
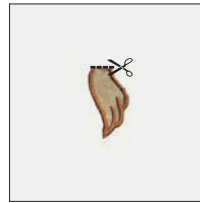
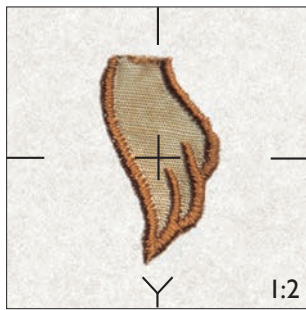

# 151

Stitches: 1 802  
Height: 32 mm  
Width: 75 mm

- 1  1056  
2227
- \* 2  1056  
2227
- 3  1005  
2215
- 4  1056  
2227

Gütermann Sulky  
Robison - Anton

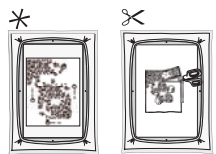
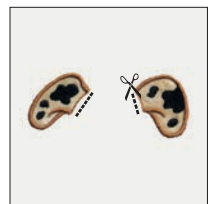

# 152

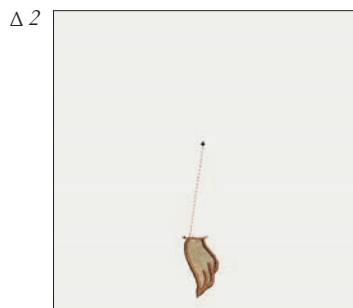

Step 1  
Δ design #142

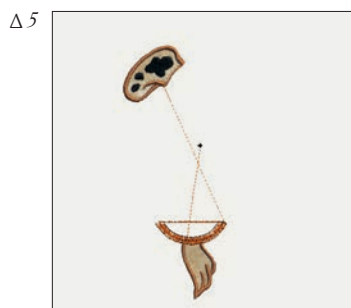



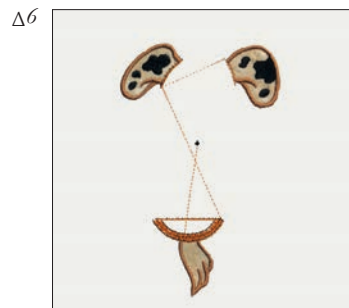













Step 2  
Δ design #143



Step 3  
Δ design #143

Stitches: 8 722  
 Height: 97 mm  
 Width: 132 mm

- 1  1056  
2227
- Δ
- 2  1056  
2227
- \*
- 3  1056  
2227
- ✂
- 4  1056  
2227
- Δ
- 5  1056  
2227
- Δ
- 6  1056  
2227
- 7  1028  
2527
- \*
- 8  1028  
2527
- ✂
- 9  1028  
2527
- 10  1056  
2227
- \*
- 11  1056  
2227
- ✂
- 12  1002  
2343
- 13  1126  
2289
- 14  1037  
2467
- 15  1117  
2374
- 16  1005  
2215
- 17  1056  
2227

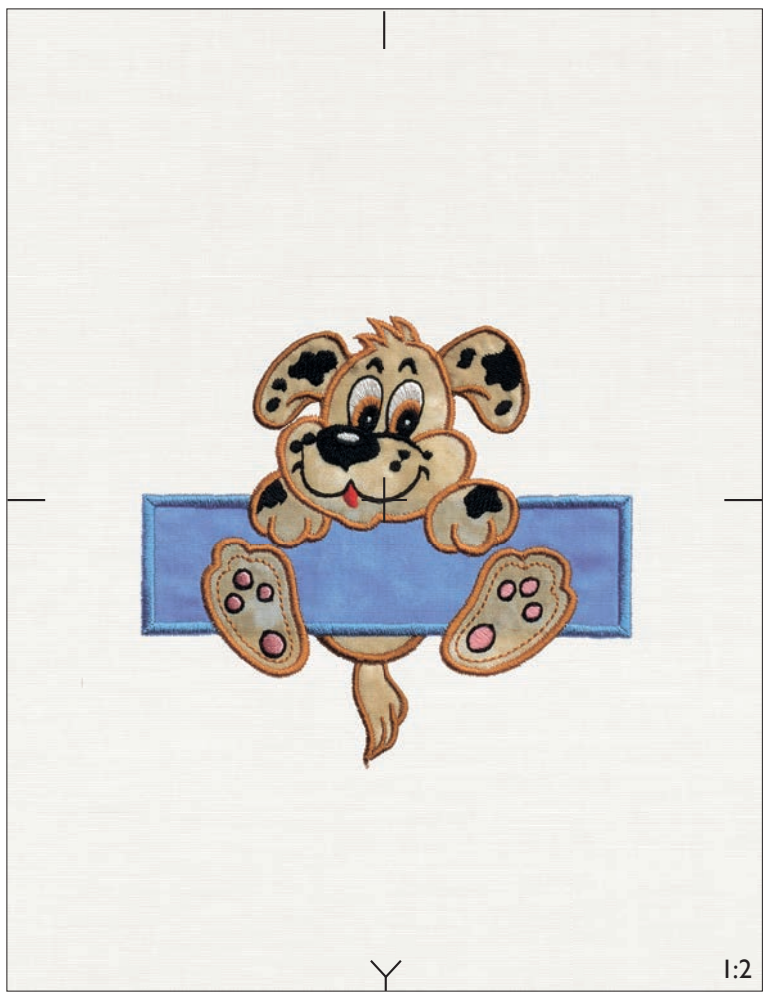



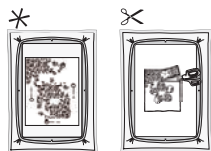

129 Pop-Up-Pals, design #9

Gütermann Sulky  
 Robison - Anton



# 153

Stitches: 4 039  
Height: 86 mm  
Width: 52 mm

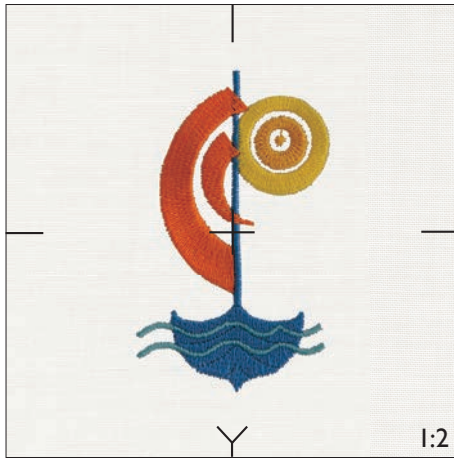

- 1  I137  
2331
- 2  I023  
2560
- 3  I076  
2528
- 4  I168  
2328
- 5  I205  
2624

Gütermann Sulky  
Robison - Anton



# 154

Stitches: 3 722  
Height: 73 mm  
Width: 63 mm



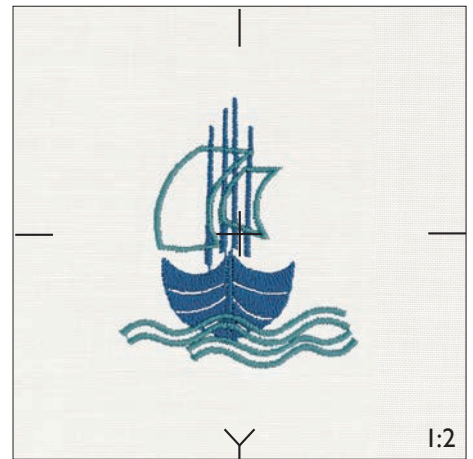

- 1  I076  
2528
- 2  I205  
2624

Gütermann Sulky  
Robison - Anton



# 155

Stitches: 4 181  
Height: 38 mm  
Width: 92 mm

- 1  I081  
2480
- 2  I198  
2341
- 3  I248  
2239
- 4  I234  
2296

Gütermann Sulky  
Robison - Anton

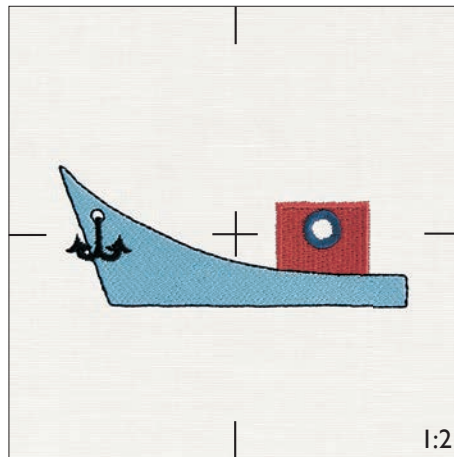

# 156

Stitches: 330  
Height: 9 mm  
Width: 59 mm



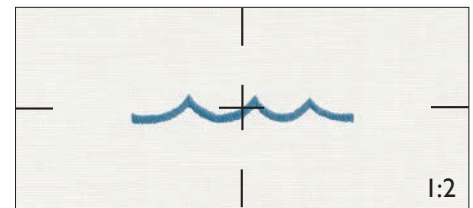

- 1  I028  
2206

Gütermann Sulky  
Robison - Anton



# 157

Stitches: 5 195  
Height: 95 mm  
Width: 63 mm



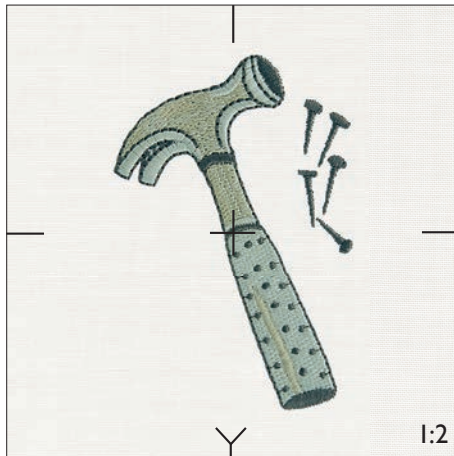

- 1  I071  
2574
- 2  I236  
2582
- 3  I011  
2618
- 4  I166  
2265

Gütermann Sulky  
Robison - Anton



# 158

Stitches: 6 397  
Height: 98 mm  
Width: 77 mm

- 1  I071  
2574
- 2  I011  
2618
- 3  I166  
2265
- 4  I128  
2273
- 5  I179  
2729

Gütermann Sulky  
Robison - Anton

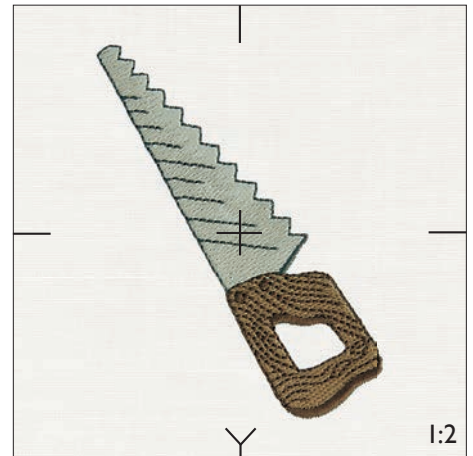

Stitches: 5 827  
Height: 105 mm  
Width: 77 mm

- 1  1002  
2574
- 2  1011  
2618
- 3  1128  
2273
- 4  1239  
2394
- 5  1166  
2265
- 6  1057  
2251

Gütermann Sulky  
Robison - Anton

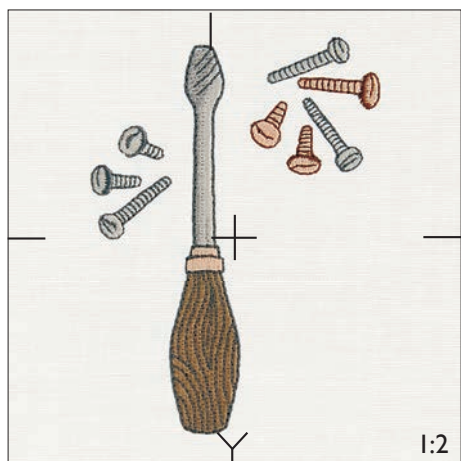

**Clarendon**

30 mm 1.2 inch

A B a b 1 2

**Clarendon**

20 mm 0.8 inch

A a 1 2

**Clarendon**

12 mm 0.5 inch

A B C D E  
a b c 1 2 3

**Palace Script**

30 mm 1.2 inch

A B a b 1 2

**Palace Script**

20 mm 0.8 inch

A a 1 2

**Palace Script**

12 mm 0.5 inch

A B C D E  
a b c 1 2 3

# DESIGNER TOPAZ™ 50 Sampler

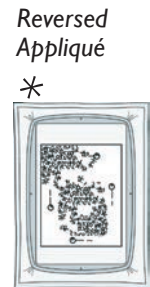
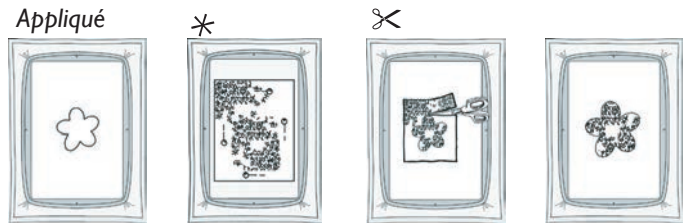
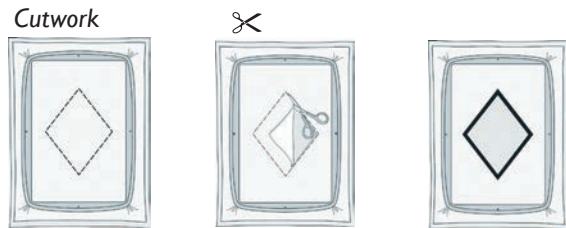
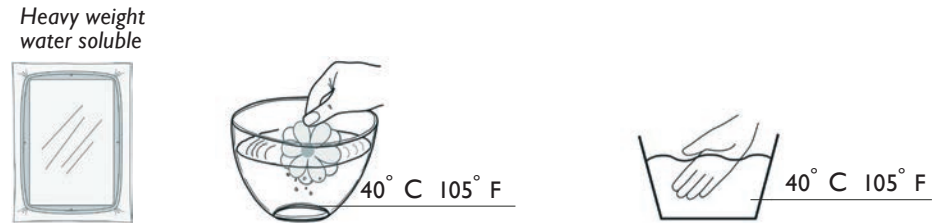
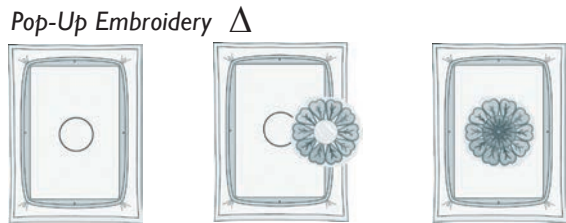
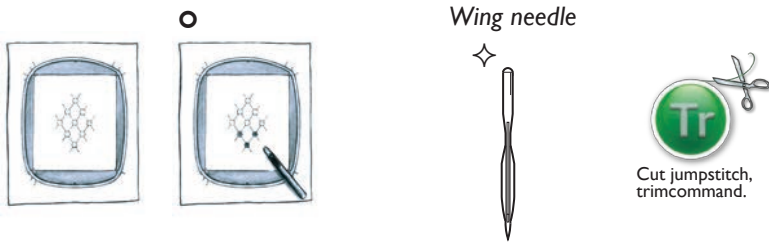

Gütermann Sulky and Robison-Anton thread numbers are given for each design.



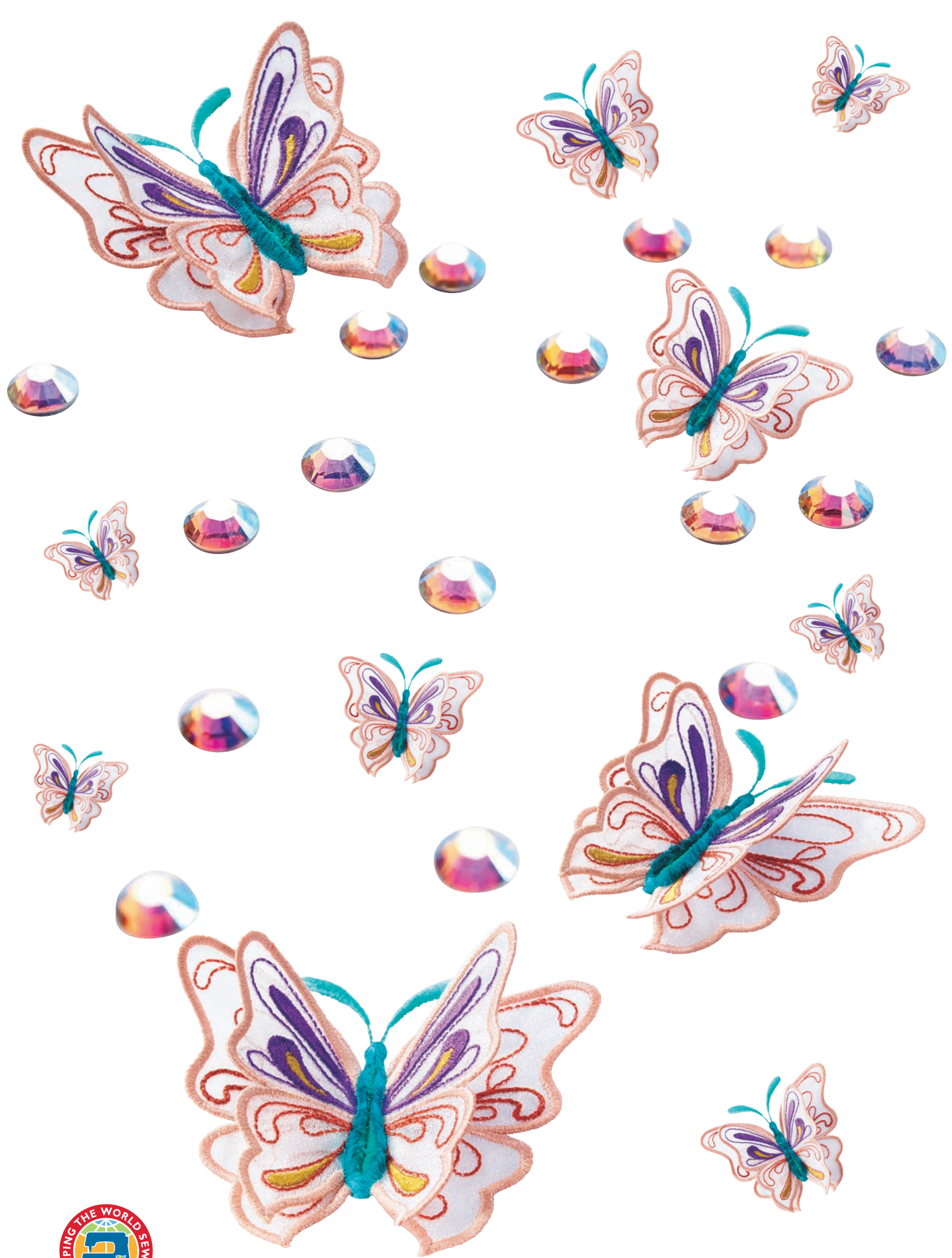

[www.myembroideries.com](http://www.myembroideries.com)  
[www.husqvarnaviking.com](http://www.husqvarnaviking.com)