



View this machine and more at:

<https://www.thesewingstudio.co.uk>

brother

Operation Manual

Embroidery Machine

Product Code: 884-T23

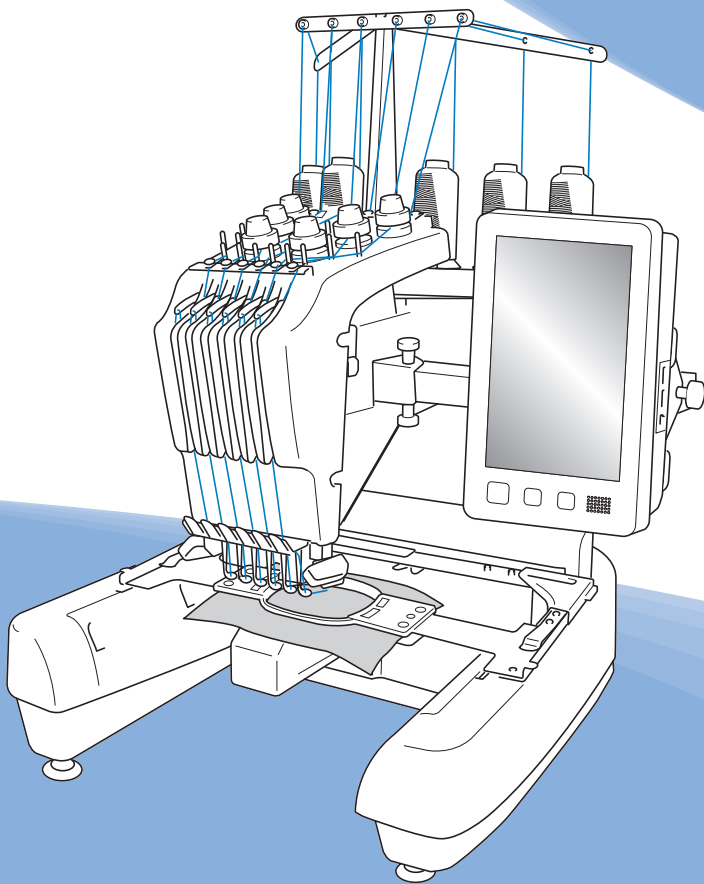

Be sure to read this document before using the machine.
We recommend that you keep this document nearby for future reference.

INTRODUCTION

Thank you for purchasing this machine. Before using this machine, carefully read the "IMPORTANT SAFETY INSTRUCTIONS", and then study this manual for the correct operation of the various functions.

In addition, after you have finished reading this manual, store it where it can quickly be accessed for future reference.

Failure to follow these instructions may result in an increased risk of personal injury or damage to property, including through fire, electrical shock, burns or suffocation.

IMPORTANT SAFETY INSTRUCTIONS

Please read these safety instructions before attempting to use the machine.

DANGER

- To reduce the risk of electric shock

1 Always unplug the machine from the electrical outlet immediately after using, when cleaning, when making any user servicing adjustments mentioned in this manual, or if you are leaving the machine unattended.

WARNING

- To reduce the risk of burns, fire, electric shock, or injury to persons.

2 Always unplug the machine from the electrical outlet when lubricating it or when making any other user servicing adjustments mentioned in the Operation Manual.

- To unplug the machine, switch the machine to the symbol "O" position to turn it off, then grasp the plug and pull it out of the electrical outlet. Do not pull on the cord.
- Plug the machine directly into the electrical outlet. Do not use an extension cord.
- Always unplug your machine if the power is cut.

3 Electrical Hazards:

- This machine should be connected to an AC power source within the range indicated on the rating label. Do not connect it to a DC power source or inverter. If you are not sure what kind of power source you have, contact a qualified electrician.
- This machine is approved for use in the country of purchase only.

4 Never operate this machine if it has a damaged cord or plug, if it is not working properly, if it has been dropped or damaged, or water is spilled on the unit. Return the machine to the nearest authorized Brother dealer or service center for examination, repair, electrical or mechanical adjustment.

- To avoid electric shock or fire; do not use a damaged power supply plug or loose electrical outlet, and ensure that the power supply plug is fully inserted and secure.
- While the machine is stored or in use if you notice anything unusual, such as an odor, heat, discoloration or deformation, stop using the machine immediately and unplug the power cord.
- When transporting the machine, be sure to lift it from the bottom positions. Lifting the machine by any other part may damage the machine or result in the machine falling, which could cause injuries.
- When lifting the machine, be careful not to make any sudden or careless movements, otherwise you may injure your back or knees.
- While the machine is being transported, be careful not to touch the operation panel, thread guides or any other part, otherwise injuries may result.

5 Always keep your work area clear:

- Never operate the machine with any air openings blocked. Keep ventilation openings of the machine free from the build up of lint, dust, and loose cloth.
- Do not use extension cords. Plug the machine directly into the electrical outlet.
- Never drop or insert any object into any opening.
- Keep fingers out of all machine openings, such as near the carriage, otherwise injuries may result.
- Do not operate where aerosol (spray) products are being used or where oxygen is being administered.
- Do not use the machine near a heat source, such as a stove or iron; otherwise, the machine, power cord or garment being embroidered may ignite, resulting in fire or an electric shock.
- Do not use this machine near an open flame; the movement of the embroidery frame could cause the garment being embroidered to catch fire.

- Do not place this machine on an unstable surface, such as an unsteady or slanted table, otherwise the machine may fall, resulting in injuries.
- While attaching or detaching an embroidery frame or other included accessory or while maintaining the machine, be careful not to hit the machine with your body or any other part of it.

6 Special care is required when embroidering:

- Always pay close attention to the needle. Do not use bent or damaged needles.
- Keep fingers away from all moving parts. Special care is required around the machine needle.
- While the machine is in operation, keep your hands away from the needle bar case and all moving parts near the needle bar case, otherwise injuries may result.
- Switch the machine to the symbol "O" position to turn it off when making any adjustments in the needle area, such as changing the needle.
- Do not use a damaged or incorrect needle plate, as it could cause the needle to break.

7 This machine is not a toy:

- Your close attention is necessary when the machine is used by or near children.
- This machine is not intended for use by young children or infirm persons without supervision.
- Young children should be supervised to ensure that they do not play with this machine.
- Do not use the included scissors or seam ripper in any other way than how they are intended. In addition, when opening a hole with the seam ripper, do not place your hands or fingers in the cutting path, otherwise injuries may result if the seam ripper slips.
- The plastic bag that this machine was supplied in should be kept out of the reach of children or disposed of. Never allow children to play with the bag due to the danger of suffocation.
- Do not use outdoors.

8 For a longer service life:

- When storing this machine, avoid direct sunlight and high humidity locations. Do not use or store the machine near a space heater, iron, halogen lamp, or other hot objects.
- Do not use cleansers or organic solvents, such as thinner, petroleum ether or alcohol, to clean the machine. Otherwise, the finish may peel off or become scratched.

- Always consult the Operation Manual when replacing or installing any assemblies, the presser feet, needle, or other parts to assure correct installation.

9 For repair or adjustment:

- Do not try to disassemble, repair or alter this machine in any way, otherwise a fire, electric shock or injuries may result.
- If the light unit is damaged, it must be replaced by an authorized Brother dealer.
- In the event a malfunction occurs or adjustment is required, first follow the troubleshooting table in the back of the Operation Manual to inspect and adjust the machine yourself. If the problem persists, please consult your local authorized Brother dealer.

Use this machine only for its intended use as described in the manual.

Use accessories recommended by the manufacturer as contained in this manual.

Use the interface cable (USB cable) included with this machine.

The contents of this manual and specifications of this product are subject to change without notice.

For additional product information and updates, visit our website at www.brother.com

SAVE THESE INSTRUCTIONS

This machine is intended for household use.

FOR USERS IN COUNTRIES EXCEPT CENELEC COUNTRIES

This appliance is not intended for use by persons (including children) with reduced physical, sensory or mental capabilities, or lack of experience and knowledge, unless they have been given supervision or instruction concerning use of the appliance by a person responsible for their safety. Children should be supervised to ensure that they do not play with the appliance.

FOR USERS IN CENELEC COUNTRIES

This appliance can be used by children aged from 8 years and above and persons with reduced physical, sensory or mental capabilities or lack of experience and knowledge if they have been given supervision or instruction concerning use of the appliance in a safe way and understand the hazards involved. Children shall not play with the appliance. Cleaning and user maintenance shall not be made by children without supervision.

FOR USERS IN THE UK, EIRE, MALTA AND CYPRUS ONLY

IMPORTANT

- In the event of replacing the plug fuse, use a fuse approved by ASTA to BS 1362, i.e. carrying the  mark, rating as marked on plug.
- Always replace the fuse cover. Never use plugs with the fuse cover omitted.

- If the available electrical outlet is not suitable for the plug supplied with this equipment, you should contact your authorized Brother dealer to obtain the correct lead.

Federal Communications Commission (FCC) Supplier's Declaration of Conformity (For U.S.A. Only)

Responsible Party: Brother International Corporation
200 Crossing Boulevard
P.O. Box 6911
Bridgewater, NJ 08807-0911
USA
TEL : (908) 704-1700

declares that the product

Product Name: Brother Embroidery Machine
Model Number: PR680W

This device complies with Part 15 of the FCC Rules. Operation is subject to the following two conditions: (1) this device may not cause harmful interference, and (2) this device must accept any interference received, including interference that may cause undesired operation.

This equipment has been tested and found to comply with the limits for a Class B digital device, pursuant to Part 15 of the FCC Rules. These limits are designed to provide reasonable protection against harmful interference in a residential installation. This equipment generates, uses, and can radiate radio frequency energy and, if not installed and used in accordance with the instructions, may cause harmful interference to radio communications. However, there is no guarantee that interference will not occur in a particular installation. If this equipment does cause harmful interference to radio or television reception, which can be determined by turning the equipment off and on, the user is encouraged to try to correct the interference by one or more of the following measures:

- Reorient or relocate the receiving antenna.
- Increase the separation between the equipment and receiver.
- Connect the equipment into an outlet on a circuit different from that to which the receiver is connected.
- Consult the authorized Brother dealer or an experienced radio/TV technician for help.

- This transmitter must not be co-located or operated in conjunction with any other antenna or transmitter.

Important

Changes or modifications not expressly approved by Brother Industries, Ltd. could void the user's authority to operate the equipment.

This equipment complies with FCC/IC radiation exposure limits set forth for an uncontrolled environment and meets the FCC radio frequency (RF) Exposure Guidelines and RSS-102 of the IC radio frequency (RF) Exposure rules. This equipment should be installed and operated keeping the radiator at least 20cm or more away from person's body.

For Users in Canada

This device complies with Industry Canada's licence-exempt RSSs. Operation is subject to the following two conditions:

- (1) This device may not cause interference; and
- (2) This device must accept any interference, including interference that may cause undesired operation of the device.

This equipment complies with FCC/IC radiation exposure limits set forth for an uncontrolled environment and meets the FCC radio frequency (RF) Exposure Guidelines and RSS-102 of the IC radio frequency (RF) Exposure rules. This equipment should be installed and operated keeping the radiator at least 20cm or more away from person's body.

For Users in Mexico

The operation of this equipment is subject to the following two conditions:

- (1) it is possible that this equipment or device may not cause harmful interference, and
- (2) this equipment or device must accept any interference, including interference that may cause undesired operation.

Declaration of Conformity (Europe and Turkey only)

We, Brother Industries, Ltd. 15-1 Naeshiro-cho, Mizuho-ku, Nagoya 467-8561 Japan declare that this product is in conformity with the essential requirements of all relevant directives and regulations applied within the European Community.

The Declaration of Conformity (DoC) can be downloaded from Brother support website. Visit support.brother.com

Declaration of Conformity for RE Directive 2014/53/ EU (Europe and Turkey only)

(Applicable to models with radio interfaces)

We, Brother Industries, Ltd. 15-1 Naeshiro-cho, Mizuho-ku, Nagoya 467-8561 Japan declare that these products are in conformity with the provisions of the RE Directive 2014/53/EU. The Declaration of Conformity (DoC) can be downloaded from Brother support website. Visit support.brother.com

Wireless LAN (Models with Wireless LAN function only)

This machine supports wireless interface.

Frequency band(s): 2400-2483.5 MHz

Maximum radio-frequency power transmitted in the frequency band(s): Less than 20 dBm(e.i.r.p)

UK Declaration of Conformity (Great Britain only)

We, Brother Industries Ltd. 15-1 Naeshiro-cho, Mizuho-ku, Nagoya 467-8561 Japan declare that these products are in conformity with the relevant UK legislation.

The Declaration of Conformity (DoC) can be downloaded from Brother support website. Visit support.brother.com

UK Declaration of Conformity for Radio Equipment Regulation 2017 (Great Britain only) (Applicable to models with radio interfaces)

We, Brother Industries Ltd. 15-1 Naeshiro-cho, Mizuho-ku, Nagoya 467-8561 Japan declare that these products are in conformity with the provisions of the Radio Equipment Regulation 2017.

The Declaration of Conformity (DoC) can be downloaded from Brother support website. Visit support.brother.com

For Users in Norway

This subsection does not apply for the geographical area within a radius of 20 km from the centre of Ny-Ålesund on Svalbard.

Dette underavsnittet gjelder ikke for det geografiske området innenfor en radius av 20 km fra sentrum av Ny-Ålesund på Svalbard.

For Users in Thailand

This telecommunication equipment conforms to NTC technical requirement.

Laser Notices (For U.S.A. only)

Laser Safety

This machine is certified as a Class 1 laser product under the U.S. Department of Health and Human Services (DHHS) Radiation Performance Standard according to the Radiation Control for Health and Safety Act of 1968. This means that the sewing machine does not produce hazardous laser radiation.

IEC 60825-1 Specification

This machine is a Class 1 laser product as defined in IEC 60825-1:2007 and IEC 60825-1:2014 specifications.

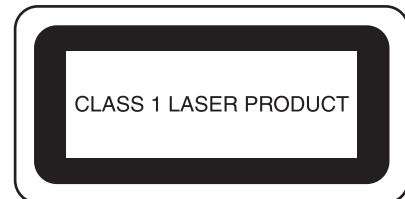

The laser beam emitted by the laser unit installed in this machine is restricted to an output at a safe level. However, the machine contains 6-milliwatt, 630-640 nanometer wavelength, 6-12 degree at parallel divergence angle, 28-40 degree at perpendicular divergence angle, InGaAlP laser diodes. Therefore, eye damage may result from disassembling or altering this machine.

Safety precautions have been designed to prevent any possible laser beam exposure to the operator.

FDA Regulations

U.S. Food and Drug Administration (FDA) has implemented regulations for laser products manufactured on and after August 2, 1976. Compliance is mandatory for products marketed in the United States. The label shown on the back of the sewing machine indicates compliance with the FDA regulations and must be attached to laser products marketed in the United States.

Brother Industries, Ltd.
15-1, Naeshiro-cho, Mizuho-ku, Nagoya 467-8561, JAPAN

This product complies with FDA performance standards for laser products except for conformance with IEC 60825-1 Ed. 3., as described in Laser Notice No. 56, dated May 8, 2019.

⚠ CAUTION

- **Use of controls, adjustments or the performance of procedures other than those specified in this manual may result in hazardous radiation exposure.**

Laser Notices (For countries except U.S.A.)

IEC 60825-1 Specification

This machine is a Class 1 laser product as defined in IEC 60825-1:2007 and IEC 60825-1:2014 specifications.

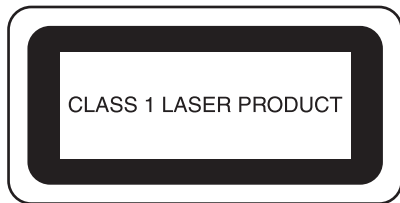

The laser beam emitted by the laser unit installed in this machine is restricted to an output at a safe level. However, the machine contains 6-milliwatt, 630-640 nanometer wavelength, 6-12 degree at parallel divergence angle, 28-40 degree at perpendicular divergence angle, InGaAlP laser diodes. Therefore, eye damage may result from disassembling or altering this machine.

Safety precautions have been designed to prevent any possible laser beam exposure to the operator.

CAUTION

- **This machine has a Class 3B Laser Diode in the Laser Unit. The Laser Unit should not be opened under any circumstances.**
- **Use of controls, adjustments or the performance of procedures other than those specified in this manual may result in hazardous radiation exposure.**

LICENSE AGREEMENT

The enclosed machine includes data, software and/or documentation (collectively "CONTENT") that are proprietary products of Brother Industries, Ltd. ("BROTHER"). BY USING THE CONTENT, THE CUSTOMER ACCEPTS THE TERMS AND CONDITIONS OF THIS AGREEMENT. BROTHER retains ownership of all rights to CONTENT and to the copies of the CONTENT included in this package. The CONTENT are licensed (not sold) to you ("CUSTOMER") under the terms and conditions of this Agreement.

CUSTOMER is licensed to:

- Use the CONTENT in combination with an embroidery machine to create embroidery.
- Use the CONTENT in combination with an embroidery machine that CUSTOMER owns or uses, provided that the CONTENT is not used on more than one embroidery machine at a time.

Except as otherwise provided herein, CUSTOMER may not:

- Allow more than one copy of the CONTENT to be available for use at any one time.
- Reproduce, modify, publish, distribute, sell, rent, sublicense or otherwise make available to others CONTENT.
- Distribute, rent, sublicense, lease, sell, transfer or assign the media card or CONTENT.
- Decompile, disassemble or otherwise reverse engineer the CONTENT or assist others to do the same.
- Alter, translate, modify or adapt the CONTENT or any part thereof for business, commercial or industrial purposes.
- Sell or otherwise distribute the EMBROIDERY created by use of the CONTENT, WHICH ORIGINALLY BEARS CERTAIN COPYRIGHT NOTICE UNDER THE NAME OF ANY THIRD PARTIES OTHER THAN BROTHER (e.g. "©DISNEY").

BROTHER retains all rights not expressly granted to CUSTOMER herein.

Nothing in this agreement constitutes a waiver of the rights of BROTHER under any law. This agreement shall be governed by the laws of Japan.

Please direct all inquiries concerning this Agreement in writing by regular mail, to Brother Industries, Ltd., 1-1-1 Kawagishi, Mizuho-ku, Nagoya 467-8562, Japan, Attention: P&H business division Sales and Marketing Dept.

WARNING LABELS

The following warning labels are on the machine.
Be sure to observe the precautions described in the labels.

Label locations

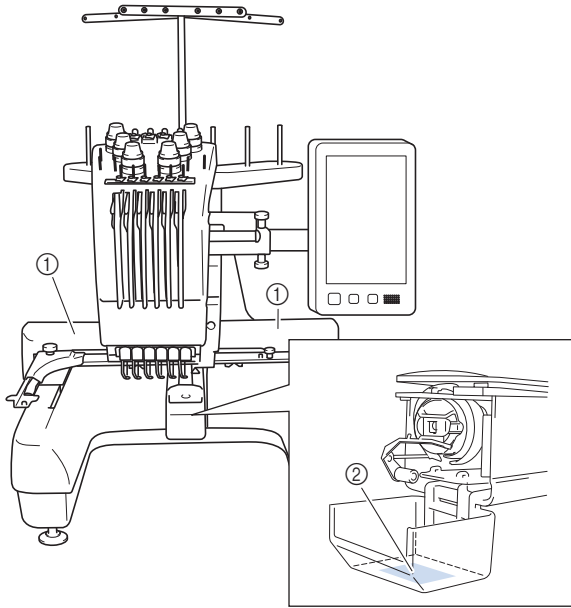

①		▲CAUTION Carriage may cause injury. Do not put hands in carriage traveling path.	▲VORSICHT Um Verletzungen mit dem Stickarm zu vermeiden, nicht die Hände in die Nähe des Stickarms halten.	▲ATTENTION Le chariot peut provoquer des blessures. Ne pas mettre les mains dans le chemin du chariot.	▲PRECAUCIÓN El carro puede provocar lesiones. No poner las manos por donde pasa el carro.	▲CUIDADO O carro de transporte pode causar ferimentos. Não coloque as mãos sobre o trilho do carro de transporte.
---	--	---	--	---	--	--

②		▲VOORZICHTIG De borduurarm kan verwondingen veroorzaken. Houdt uw handen buiten bereik van de borduurarm.	▲ATTENZIONE Il carrello potrebbe ferirvi. Non appoggiate la mano nel percorso del carrello.	▲ОСТОРОЖНО! Движущаяся каретка может быть причиной травмы. Не кладите руки на пути движения каретки.	▲注意 刺しゅう機のキャリッジや刺しゅう針が動いているときに、手や物を近づけないでください。 ケガの原因になります。	▲注意 在绣花机的车钩或绣花针移动时，为避免造成伤害，请不要将手或物品靠近。
---	--	--	--	---	---	--

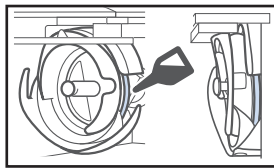

Please put a drop of oil onto the hook once a day before use.

TRADEMARKS

IBM is a registered trademark or a trademark of International Business Machines Corporation.
WPA™ and WPA2™ are trademarks of Wi-Fi Alliance®.

Any trade names and product names of companies appearing on Brother products, related documents and any other materials are all trademarks or registered trademarks of those respective companies.

OPEN SOURCE LICENSING REMARKS

This product includes open-source software.
To see the open source licensing remarks, please go to the manual download section on your model's home page of Brother support website at <http://s.brother/cpan/>.

COPYRIGHT AND LICENSE

This product includes software developed by the following vendor:

©2008 Devicescape Software, Inc.

PRECAUTION FOR WIRELESS CONNECTION

Make sure you use a router or firewall when connecting your machine to the Internet to protect it against unauthorized access from the Internet.

CONTENTS

Chapter 1 GETTING READY 11

NAMES OF MACHINE PARTS	11
Included accessories	12
Accessories that are included in some countries or regions	14
Optional accessories	14
SETTING UP THE MACHINE	16
Setup and transporting precautions.....	16
Setup location	17
Setting up the machine	18
Adjusting the operation panel position	18
Preparing the thread guide assembly	19
Preparing the spool stand	20
Attaching the embroidery frame holder	21
TURNING ON THE MACHINE	22
LCD SCREEN	24
Using the settings key	25
Using the machine help	29
WIRELESS NETWORK CONNECTION FUNCTIONS	30
Operations available with a wireless network connection	30
Enabling a wireless network connection	31
Setting up the wireless network connection	31
MONITORING APP	33

Chapter 2 BASIC EMBROIDERY 35

BASIC PROCEDURES	35
INSTALLING THE BOBBIN	35
Removing the bobbin case	35
Installing the bobbin	36
Installing the bobbin case	37
SELECTING AN EMBROIDERY PATTERN	37
General pattern selection	37
Embroidery patterns	38
Frame patterns.....	39
Utility embroidery patterns/Large buttonhole patterns	39
Monogram and frame designs	40
Character patterns	41
Decorative alphabet patterns.....	43
Combining patterns	44
EDITING THE EMBROIDERY PATTERN	46
Understanding the pattern editing screen	46
Changing the size and the density of the pattern.....	49
Trimming jump stitches	49
Combining the separated character patterns	50
Changing the thread density	50
Aligning the embroidery patterns.....	51
Designing repeated patterns	51
EDITING COLORS	55
Specifying multi-color text.....	55
Changing the colors of the pattern	55
Finding new color schemes with the Color Shuffling function.....	56
SWITCHING THE THREAD COLORS ON THE SCREEN	58
SELECTING/MANAGING THREAD COLORS FOR EACH NEEDLE BAR [Manual Color Sequence] ...	59
Convenience of the manual color sequence	59
Specifying the manual color sequence	60
Using the manual color sequence	60
Precautions on the manual color sequence	61
PREVIEWING THE IMAGE	61
Checking a preview image	61
PREPARING THE FABRIC	62
Attaching stabilizer (backing) to fabric.....	62

Fabric/stabilizer compatibility chart	62
Hooping the fabric in the embroidery frame	63

ATTACHING THE EMBROIDERY FRAME TO THE MACHINE 66

Attaching the embroidery frame.....	66
Correctly using the embroidery frames.....	67

SPECIFYING EMBROIDERING SETTING 70

Understanding the embroidering settings screen	70
Automatic lock stitch setting	72
Thread color sorting.....	73

CHECKING THE POSITION OF THE PATTERN 74

Checking the needle drop point with the embroidery crosshair positioning laser	74
Checking the embroidery pattern.....	74

UPPER THREADING 76

Checking the needle bars and thread colors.....	76
Upper threading	77
Threading the needle	80

PERFORMING THE EMBROIDERY 82

Starting embroidering	82
Stopping embroidering	83
Understanding the embroidering screen	84

REMOVING THE EMBROIDERY FRAME 86

EMBROIDERING A PATTERN CONTAINING SEVEN OR MORE COLORS 86

Checking if thread spool changes are necessary.....	86
---	----

CHANGING THE THREAD SPOOLS 87

About spool thread indicators	87
Easily changing the thread spools	88

ADJUSTING WHILE EMBROIDERING 89

If the thread breaks or the bobbin thread runs out while embroidering	89
Embroidering from the beginning or middle of the pattern ...	91
Resume embroidering after turning off the machine.....	92

Chapter 3 ADVANCED EMBROIDERY 93

VARIOUS EMBROIDERY FUNCTIONS 93

Basting embroidery	93
Embroidering appliqué patterns	94
Creating an appliqué piece	95
Using a frame pattern to create appliqués	97
Creating stippling or echo quilting patterns automatically....	98

USING THE EMBROIDERY CROSSHAIR

POSITIONING LASER FUNCTION TO ALIGN THE EMBROIDERING POSITION 98

MAKING EMBROIDERY ADJUSTMENTS 102

Adjusting the tension of the bobbin thread.....	102
Adjusting the tension of the upper thread.....	104
Setting the machine to stop at color changes	105
Temporary needle bar setting.....	106
Uninterrupted embroidering (one color)	106
Reserved needle bar and embroidery speed settings	107
Changing the display guides	109
Changing the thread color information	109
Specifying jump stitch trimming / "DST" jump codes for trimming.....	109
Deleting short stitches.....	110
Specifying the remaining length of thread.....	110
Changing the embroidery basting distance.....	110
Deselect region setting.....	111
Starting/ending position settings.....	112

USING THE MEMORY FUNCTION 116

Saving embroidery patterns.....	116
Retrieving embroidery patterns	116

**SENDING EMBROIDERY PATTERNS FROM A
COMPUTER TO THE MACHINE**

(LINK FUNCTION)..... 117
Operations available with the Link function..... 117
Embroidering using the Link function..... 117
Disabling the Link function..... 120
EMBROIDERY APPLICATIONS 121
Embroidering split (large-size) patterns..... 121
USING THE OPTIONAL BOBBIN WINDER..... 123
Optional bobbin winder and its accessories..... 123
Setting up the optional bobbin winder..... 124
Connecting the AC adapter..... 124
Winding the bobbin..... 125

Chapter 4 ADMINISTRATOR MODE 129

ADMINISTRATOR LOCK 129
Configuring administrator lock..... 129
Accessing settings screens when administrator lock is
enabled..... 129
Canceling administrator lock..... 130
OPERATOR LOCK 130
Configuring operator lock..... 130
Accessing screens when the LCD screen is locked..... 131
KEY OPTIMIZATION MODE..... 132
Specifying/changing key display optimization..... 132
Activating/deactivating key display optimization..... 135
Recalling key display optimization settings..... 135

Chapter 5 APPENDIX 137

MAINTENANCE 137
Cleaning the LCD..... 137
Cleaning the machine surface..... 137
Cleaning the hook..... 137
Cleaning around the needle plate..... 138
Cleaning the bobbin case..... 139
Cleaning the thread paths of the upper threads..... 139
Replacing the needle..... 140
Oiling the machine..... 142
About the maintenance message..... 143
TROUBLESHOOTING..... 144
List of Symptoms..... 144
Error messages..... 150
How can I find the wireless security information (SSID and
network key)..... 154
If the machine does not respond when a key is touched 155
SPECIFICATIONS 156
Machine specifications..... 156
UPDATING YOUR MACHINE'S SOFTWARE... 158
Using a wireless LAN connection to update..... 158
Using USB media to update..... 159
INDEX 160

Chapter 1 GETTING READY

Note

- Be sure to install the latest software. Refer to “UPDATING YOUR MACHINE’S SOFTWARE” on page 158.

NAMES OF MACHINE PARTS

Main parts

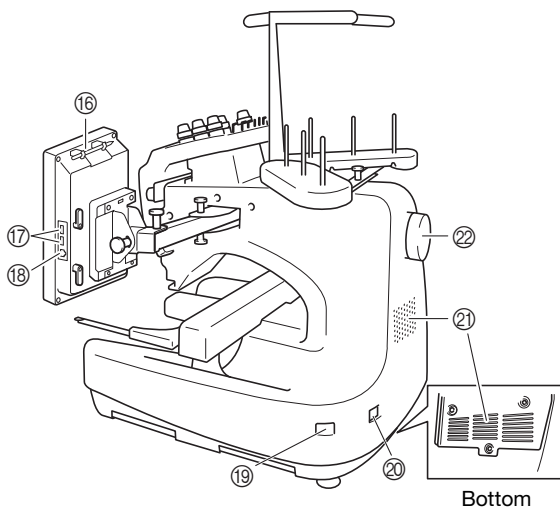
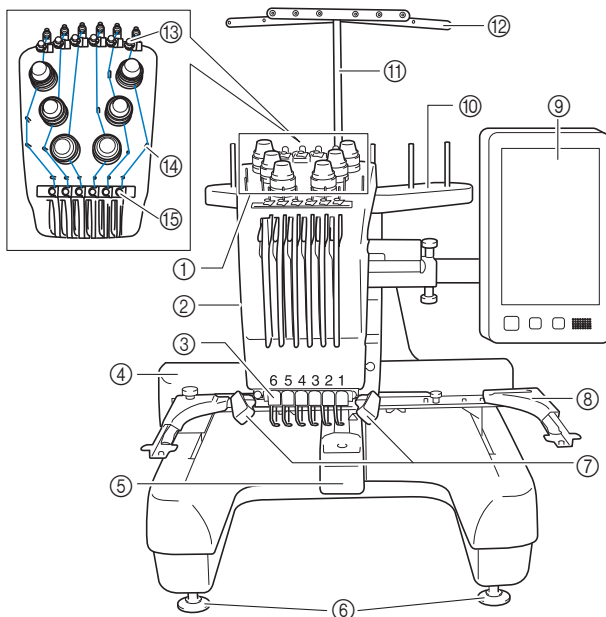

- ① **Thread tension knobs (page 104)**
- ② **Needle bar case**
Moves to the left and right to move the needle to the embroidering position.
- ③ **Lower thread guide**
- ④ **Carriage**
Attach the embroidery frame to the carriage. When the machine is turned on or when the machine is embroidering, the carriage moves forward, backward, left and right.
- ⑤ **Hook cover/Hook (page 35)**
- ⑥ **Feet (page 18)**
- ⑦ **Embroidery light**
The brightness of the embroidery light can be adjusted in the settings screen.
- ⑧ **Embroidery frame holder (page 21)**
- ⑨ **Operation panel (page 12)**
- ⑩ **Spool stand (page 20)**
- ⑪ **Thread guide assembly support**
- ⑫ **Thread guide (page 78)**
- ⑬ **Upper thread guide (page 78)**
- ⑭ **Thread guide pins (page 79)**
- ⑮ **Middle thread guide (page 79)**
- ⑯ **Touch pen holder**
Use the touch pen holder to hold the touch pen when not in use.
- ⑰ **USB port for media (page 116, page 159)**
In order to send patterns from/to USB media, plug the USB media directly into the USB port.
- ⑱ **USB port for computer (page 116)**
In order to import/export patterns between a computer and the machine, plug the USB cable into the USB port.
- ⑲ **Main power switch (page 22)**
Use the main power switch to turn the machine on (“I”) and off (“O”).
Do not turn the power on soon after turning the power off. It is recommended that you wait 5 seconds before turning the power back on.
- ⑳ **Power cord receptacle (page 22)**
- ㉑ **Ventilation slots**
The ventilation slots allow the air surrounding the motor to circulate. Do not cover the ventilation slots while the machine is being used.
- ㉒ **Handwheel**
Rotate the handwheel to move the needle up and down. Be sure to rotate the handwheel toward the LCD panel.

■ Operation panel

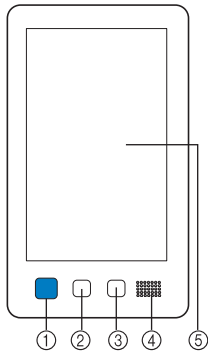

① “Start/Stop” button

Press the “Start/Stop” button to start or stop the machine. The lighting status and color of the button changes depending on the operation condition of the machine.

- Lit in red : When the machine cannot start embroidering
- Flashing in green : When the machine can start embroidering
- Lit in green : While the machine is embroidering
- Flashing in orange : When the machine can cut the thread
- Off : When the machine is turned off

② Thread trimming button

Press the thread trimming button to trim both the upper and the bobbin threads.

③ Automatic needle-threading button

Press the automatic needle threading button to thread the needle.















④ Speaker









⑤ LCD (touch panel)









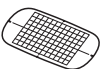

Touch the keys that appear on the touch panel to select and edit patterns and confirm various information.

Included accessories

After opening the box, check that the following accessories are included. If any item is missing or damaged, contact your authorized Brother dealer.

	Part Name
	Part Code
1. 	Accessory case XC6482-051
2. 	Needle set × 2 XC6469-001
3. 	Prewound bobbin × 6 XH3619-001
4. 	Spool net × 6 S34455-000
5. 	Seam ripper XF4967-001
6. 	Scissors XF2052-001
7. 	Tweezers XC6542-051
8. 	Touch pen XA9940-051
9. 	Needle changing tool (Threader) XF2212-101
10. 	Needle plate cover XC6499-151
11. 	Spacer (on machine) XF1978-001
12. 	Phillips screwdriver XC6543-051
13. 	Standard screwdriver X55468-051
14. 	Allen screwdriver XC5159-051

	Part Name
	Part Code
15.	3-way screwdriver  XH4670-001
16.	Wrench 13 mm × 10 mm  XC6159-051
17.	Oiler  D01H2M-001 (Korea) D01H2N-001 (other areas)
18.	Cleaning brush  X59476-051
19.	Weight (L)  XC5974-151
20.	Spool mat × 6  XC7134-051
21.	Spool cap × 6  130012-057
22.	USB cable  XD1851-051
23.	Embroidery frame (extra-large) 300 mm (W) × 200 mm (H) (11-3/4 inches (W) × 7-7/8 inches (H)) PRH300 (Americas) PRH300: XG6645-001 (Europe) PRH300CN: 115D02E6019 (China) PRH300: 115D02E7019 (other areas)
24.	Embroidery frame (large) 180 mm (W) × 130 mm (H) (7-1/8 inches (W) × 5-1/8 inches (H)) PRH180 (Americas) PRH180: XG6647-001 (Europe) PRH180CN: 115D02E6018 (China) PRH180: 115D02E7018 (other areas)
25.	Embroidery frame (medium) 100 mm (W) × 100 mm (H) (4 inches (W) × 4 inches (H)) PRH100 (Americas) PRH100: XG6649-001 (Europe) PRH100CN: 115D02E6017 (China) PRH100: 115D02E7017 (other areas)
26.	Embroidery frame (small) 60 mm (W) × 40 mm (H) (2-3/8 inches (W) × 1-1/2 inches (H)) PRH60 (Americas) PRH60: XG6651-001 (Europe) PRH60CN: 115D02E6020 (China) PRH60: 115D02E7020 (other areas)
27.	Embroidery sheet (extra large) 300 mm (W) × 200 mm (H) (11-3/4 inches (W) × 7-7/8 inches (H)) XC5704-051 

	Part Name
	Part Code
28.	Embroidery sheet (large) 180 mm (W) × 130 mm (H) (7-1/8 inches (W) × 5-1/8 inches (H)) XC5721-051 
29.	Embroidery sheet (medium) 100 mm (W) × 100 mm (H) (4 inches (W) × 4 inches (H)) XC5759-051 
30.	Embroidery sheet (small) 60 mm (W) × 40 mm (H) (2-3/8 inches (W) × 1-1/2 inches (H)) XC5761-051 
31.	Embroidery frame holder A (with white corner covers) XF2222-001 
32.	Embroidery frame holder B (with light gray corner covers) XF2223-001 
33.	Operation Manual  This manual
34.	Quick Reference Guide  Visit your authorized Brother dealer.
35.	Embroidery Design Guide  Visit your authorized Brother dealer.
36.	Power cord  Visit your authorized Brother dealer.
37.	Bobbin case (on machine)  XC7206-001

Memo

- The included touch pen can be stored in the touch pen holder on the back of the operation panel. (page 11)

Accessories that are included in some countries or regions







	Part Name
	Part Code
1.	Cap frame set PRCF3 (Americas) PRCF3: XE2158-201 (Europe) PRCF3CN: 115D02E6002 (China) PRCF3: 115D02E7002 (other areas)
2.	Embroidery Design Guide (additional) Visit your authorized Brother dealer.
3.	Bobbin winder set (Refer to page 123.) PRBW1

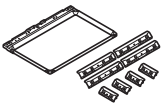
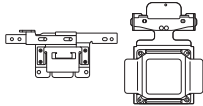
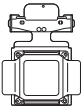
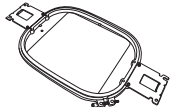
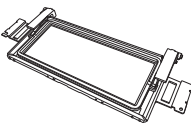

Optional accessories



The following are available as optional accessories to be purchased separately.

	Part Name
	Part Code
1.	Tubular frame table PRTT1 (Americas) PRTT1: D01FAF-001 (Europe) PRTT1CN: 115K02E6002 (China) PRTT1AP: 115K02E7002 (other areas)
2.	Wide table PRWT1 (Americas) PRWT1: XG6731-001 (Europe) PRWT1CN: 115K02E6001 (China) PRWT1: 115K02E7001 (other areas)
3.	Embroidery Stand PRNSTD2 (Americas) VRPRNSTD: XG3199-001 (Europe) VRPRNSTDCN: 115Z05E6005 (China) VRPRNSTD: 115Z05E7005 (other areas)
4.	Flat brim cap frame set PRCF5 (Americas) PRCF5: D01FAB-001 (Europe) PRCF5CN: 115D02E600J (China) PRCF5AP: 115D02E700J (other areas)

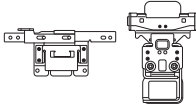
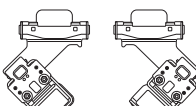
	Part Name
	Part Code
5.	Flat brim cap frame 130 mm (W) × 60 mm (H) (5-1/8 inches (W) × 2-3/8 inches (H)) PRCFH5 (Americas) PRCFH5: D01FA5-001 (Europe) PRCFH5CN: 115D02E600G (China) PRCFH5AP: 115D02E700G (other areas)
6.	Cap frame 130 mm (W) × 60 mm (H) (5-1/8 inches (W) × 2-3/8 inches (H)) PRCFH3 (Americas) PRCFH3: XG6695-001 (Europe) PRCFH3: 115D02E7008 (other areas)
7.	Mounting jig (for cap frame (PRCFH1/PRCFH2/PRCFH3)) PRCFJ2 (Americas) PRCFJ2: XG6661-001 (Europe) PRCFJ2: 115D02E7009 (other areas)
8.	Cylinder frame set PRCL1 (Americas) PRCL1: XG6697-001 (Europe) PRCL1CN: 115D02E6011 (China) PRCL1: 115D02E7011 (other areas)
9.	Cylinder frame 90 mm (W) × 80 mm (H) (3-1/2 inches (W) × 3 inches (H)) PRCLH1 (Americas) PRCLH1: XG6699-001 (Europe) PRCLH1: 115D02E7010 (other areas)
10.	Versatile magnetic frame M kit 100 mm (W) × 100 mm (H) (4 inches (W) × 4 inches (H)) PRVMFMKIT (Americas) PRVMFMKIT: D01XJY-001 (Europe) PRVMFMKITCN: 115D02E600M (China) PRVMFMKITAP: 115D02E700M (other areas)
11.	Versatile magnetic frame M 100 mm (W) × 100 mm (H) (4 inches (W) × 4 inches (H)) PRVMFM (Americas) PRVMFM: D01XK7-001 (Europe) PRVMFMCN: 115D02E600N (China) PRVMFMAP: 115D02E700N (other areas)
12.	Versatile magnetic frame L kit 180 mm (W) × 130 mm (H) (7-1/8 inches (W) × 5-1/8 inches (H)) PRVMFLKIT (Americas) PRVMFLKIT: D01XHD-001 (Europe) PRVMFLKITCN: 115D02E600P (China) PRVMFLKITAP: 115D02E700P (other areas)
13.	Versatile magnetic frame L 180 mm (W) × 130 mm (H) (7-1/8 inches (W) × 5-1/8 inches (H)) PRVMFL (Americas) PRVMFL: D01XHM-001 (Europe) PRVMFLCN: 115D02E600L (China) PRVMFLAP: 115D02E700L (other areas)

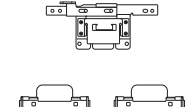
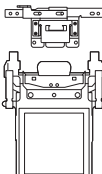
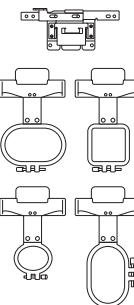
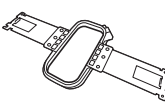
	Part Name
	Part Code
14.	 <p>Magnetic sash frame 360 mm (W) × 200 mm (H) (14 inches (W) × 7-7/8 inches (H))</p> <p>PRMS360 (Americas) PRMS360: D01FAN-001 (Europe) PRMS360CN: 115D02E600K (China) PRMS360AP: 115D02E700K (other areas)</p> <p>* Embroidery area: 300 mm (W) × 200 mm (H) (11-3/4 inches (W) × 7-7/8 inches (H))</p>
15.	 <p>Magnetic frame set 50 mm (W) × 50 mm (H) (2 inches (W) × 2 inches (H))</p> <p>PRMHA50 (Americas) PRMFA50: XG8593-001 (Europe) PRMFA50AP: 115D02E700E (other areas)</p>
16.	 <p>Magnetic frame 50 mm (W) × 50 mm (H) (2 inches (W) × 2 inches (H))</p> <p>PRMH50 (Americas) PRMF50: XG8597-001 (Europe) PRMF50AP: 115D02E700F (other areas)</p>
17.	 <p>Quilt frame 200 mm (W) × 200 mm (H) (7-7/8 inches (W) × 7-7/8 inches (H))</p> <p>PRPQF200 (Americas) PRPQF200: XG6727-001 (Europe) PRPQF200CN: 115D02E6025 (China) PRPQF200: 115D02E7025 (other areas)</p>
18.	 <p>Border frame 300 mm (W) × 100 mm (H) (11-3/4 inches (W) × 4 inches (H))</p> <p>PRPBF1 (Americas) PRPBF1: XG6729-001 (Europe) PRPBF1CN: 115D02E6022 (China) PRPBF1: 115D02E7022 (other areas)</p>
19.	 <p>Round frame set</p> <p>PRPRFK1 (Americas) PRPRFK1: XG6725-001 (Europe) PRPRFK1CN: 115D02E6029 (China) PRPRFK1: 115D02E7029 (other areas)</p>
20.	 <p>Round frame (Ø100 mm (4 inches))</p> <p>PRPRF100 (Americas) PRPRF100: XG6737-001 (Europe) PRPRF100CN: 115D02E6026 (China) PRPRF100: 115D02E7026 (other areas)</p>
21.	 <p>Round frame (Ø130 mm (5 inches))</p> <p>PRPRF130 (Americas) PRPRF130: XG6739-001 (Europe) PRPRF130CN: 115D02E6027 (China) PRPRF130: 115D02E7027 (other areas)</p>
22.	 <p>Round frame (Ø160 mm (6 inches))</p> <p>PRPRF160 (Americas) PRPRF160: XG6741-001 (Europe) PRPRF160CN: 115D02E6028 (China) PRPRF160: 115D02E7028 (other areas)</p>
23.	 <p>Embroidery frame holder C (with dark gray corner covers)</p> <p>PRPARMC (Americas) PRPARMC: XG6743-001 (Europe) PRPARMC: 115D02E7021 (other areas)</p>

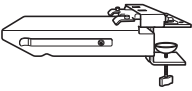
	Part Name
	Part Code
24.	 <p>Flat frame 300 mm (W) × 200 mm (H) (11-3/4 inches (W) × 7-7/8 inches (H))</p> <p>PRF300 (Americas) PRF300: XG6693-001 (Europe) PRF300: 115D02E7016 (other areas)</p>
25.	 <p>Clamp frame S straight set 45 mm (W) × 24 mm (H) (1-3/4 inches (W) × 7/8 inches (H))</p> <p>PRCLP45B (Americas) PRCLP45B: XF2251-001 (Europe) PRCLP45BCN: 115D02E6012 (China) PRCLP45B: 115D02E7012 (other areas)</p>
26.	 <p>Clamp frames S L & R 45 mm (W) × 24 mm (H) (1-3/4 inches (W) × 7/8 inches (H))</p> <p>PRCLP45LR (Americas) PRCLP45LR: XF2255-001 (Europe) PRCLP45LRCN: 115D02E6013 (China) PRCLP45LR: 115D02E7013 (other areas)</p>
27.	 <p>Clamp frame S straight 45 mm (W) × 24 mm (H) (1-3/4 inches (W) × 7/8 inches (H))</p> <p>PRCLP45S (Americas) PRCLP45S: 115D02E7015 (other areas*)</p> <p>* Not available in Europe</p>
28.	 <p>Clamp frames S L & R set 45 mm (W) × 24 mm (H) (1-3/4 inches (W) × 7/8 inches (H))</p> <p>PRCLP45LRD (Americas) PRCLP45LRD: 115D02E7014 (other areas*)</p> <p>* Not available in Europe</p>
29.	 <p>Clamp frame M set 100mm (W) × 100 mm (H) (4 inches (W) × 4 inches (H))</p> <p>PRCLPM1 (Americas) PRCLP100B: XG6235-001 (Europe) PRCLPM1CN: 115D02E600B (China) PRCLPM1AP: 115D02E700B (other areas)</p>
30.	 <p>Compact frame set 70: 70 mm (W) × 41 mm (H) (2-3/4 inches (W) × 1-5/8 inches (H)) 50: 50 mm (W) × 50 mm (H) (2 inches (W) × 2 inches (H)) 44: 44 mm (W) × 38 mm (H) (1-3/4 inches (W) × 1-1/2 inches (H))</p> <p>Portrait orientation: 33 mm (W) × 75 mm (H) (1-5/16 inches (W) × 2-15/16 inches (H))</p> <p>PRHCK1 (Americas) PRSFK1: XG6209-001 (Europe) PRHCK1CN: 115D02E600A (China) PRHCK1AP: 115D02E700A (other areas)</p>
31.	 <p>Sleeve frame 70 mm (W) × 200 mm (H) (2-3/4 inches (W) × 7-7/8 inches (H))</p> <p>PRHSL200 (Americas) PRHSL200: XG5284-001 (Europe) PRHSL200CN: 115D02E600C (China) PRHSL200AP: 115D02E700C (other areas)</p>

	Part Name
	Part Code
32.	Free-arm mounting jig
	PRMHJ1 (Americas) PRMFJ1: XH1533-001 (Europe) PRMFJ1AP: 115D02E700H (other areas)
33.	Metal bobbin
	100376-051
34.	Weight (S)
	XC6631-051

Note

- Visit your nearest authorized Brother dealer for a complete listing of optional accessories for your machine.

Memo

- Always use accessories recommended for this machine.
- All specifications are correct at the time of printing. Please be aware that some specifications may change without notice.

SETTING UP THE MACHINE

Setup and transporting precautions

⚠ CAUTION

- The temperature of the operating environment should be between 5 °C (40 °F) and 40 °C (104 °F). If the machine is operated in an environment that is either too cold or too hot, the machine may malfunction.
- Do not use the machine in a location where it will be exposed to direct sunlight, otherwise the machine may malfunction.
- Set up the machine with its four adjustable feet completely in contact with the desk or table, so that the machine is level.
- Do not block the ventilation slots at the back and on the rear underside of the machine, such as by putting anything under the machine, and do not allow lint or dust to accumulate in the ventilation slots, otherwise the machine's motor may overheat, resulting in a fire or in damage to the machine.
- The machine weight is approximately 38 kg (83 lb). The transporting or setting up of the machine should be performed by two people.
- When transporting the machine, be sure to have two people lift the machine from the bottom at the indicated slots (①). Lifting the machine from any other area may damage the machine or result in the machine falling, which could cause injuries.

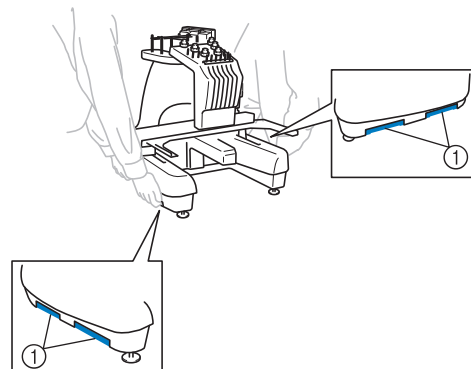

- When lightning occurs, turn off the machine and unplug the power supply cord. Lightning may cause the machine to malfunction.
- Do not plug in the power supply cord until setup of the machine is completed, otherwise injuries may result if the "Start/Stop" button is accidentally pressed and the machine starts embroidering.

- When lubricating the machine, wear protective eyeglasses and gloves to prevent the oil or grease from getting into your eyes or on your skin. Do not put the oil or grease into your mouth. Keep the oil and grease out of the reach of children.
- While attaching or detaching an embroidery frame or other included accessory or while maintaining the machine, be careful nothing interferes with the moving parts of the machine.

Setup location

Set up the machine in a location that meets the following requirements.

- Position the machine a minimum of 50 mm (2 inches) away from the wall.
- Allow sufficient space around the machine.
- Place no objects within the moving range of the embroidery frame.
- Set-up machine near an electrical outlet.
- Use a level and stable surface, such as a desk or stand.
- Use a surface that can support the weight of the machine (about 38 kg (83 lb)).
- Allow open space around the ventilation slots at the back and on the rear underside of the machine

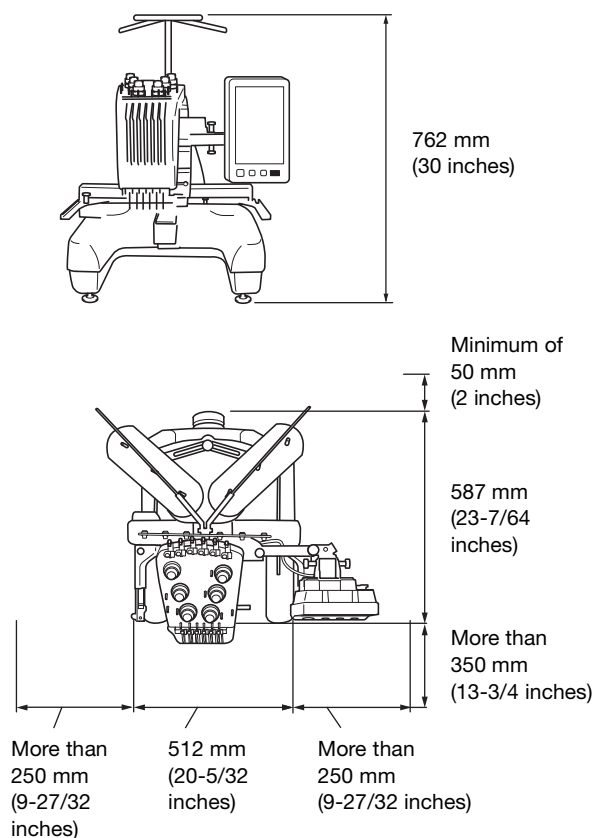

⚠ CAUTION

- In order to prevent malfunctions or damage, do not set up the machine in a location exposed to the following conditions.
 - Liquids, such as water
 - Extreme dust
 - Direct sunlight
 - Extremely high or extremely low temperatures. The operating environment should be between 5 °C (40 °F) and 40 °C (104 °F).
 - Insufficient space
 - Objects within the moving range of the embroidery frame
 - Blocked ventilation slots at the back and on the rear underside of the machine
 - An unstable surface
- Do not use extension cords or multi-plug adapters with any other appliances plugged in to them.

Setting up the machine

When setting up the machine, adjust the legs so that the machine is steady.

1 Make sure that all packing tape affixed to the machine is peeled off and that all packing material is removed.

2 Set up the machine while making sure that there is sufficient space around it.

For details on the setup location, refer to page 17.

3 Adjust the legs so that the machine is steady.

Use the included wrench to loosen the lock nut on the leg that you wish to adjust.

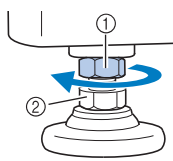

- ① Lock nut
- ② Adjustable foot nut

→ The foot can be turned.

4 Use the included wrench to turn the adjustable foot nut on the foot.

Turning the nut in direction ① lengthens the leg; turning the nut in direction ② shortens the leg.

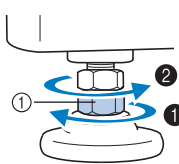

- ① Adjustable foot nut

- Adjust all four legs so that they securely contact the desk or table, and the machine is level.

5 After adjusting the legs to the desired length, use the included wrench to tighten the nuts.

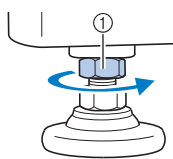

- ① Lock nut

6 Press down on each corner of the machine to check that it is stable.

If it is still unstable, perform steps ③ through ⑤ again to adjust the legs.

Adjusting the operation panel position

1 Loosen 2 thumb screws to bring the operation panel forward.

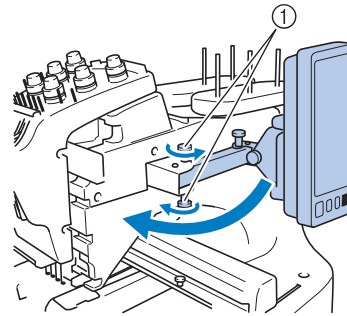

- ① Thumb screws

Note

- Using the 3-way screwdriver included, loosen and firmly tighten the thumb screws.

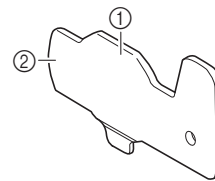

- ① Use this part to tighten the upper and lower thumb screws.
- ② Use this part to tighten the left and right thumb screws.

2 Adjust the operation panel to an easy-to-operate position, and then tighten the thumb screws.

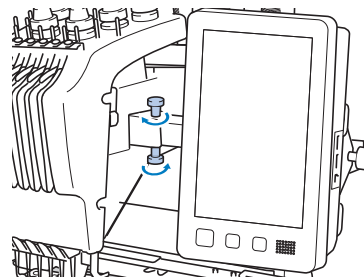

3 Adjust the orientation of the operation panel.

Loosen the thumb screw, adjust the operation panel to an easy-to-view orientation, and then tighten the thumb screw.

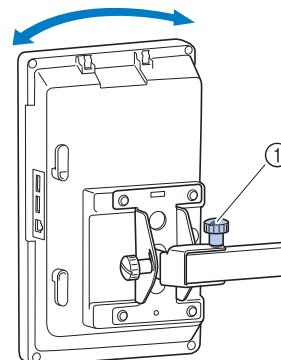

- ① Thumb screw

4 Adjust the angle of the operation panel.

Loosen the 2 thumb screws behind the operation panel, adjust the operation panel to an easy-to-view angle, and then tighten the thumb screws.

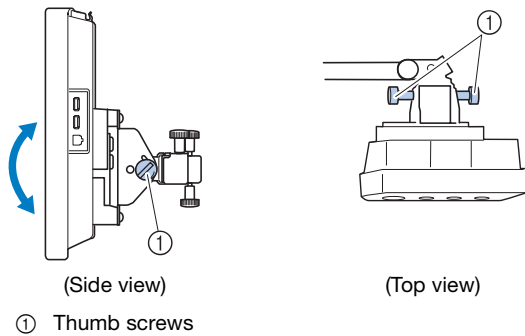

Preparing the thread guide assembly

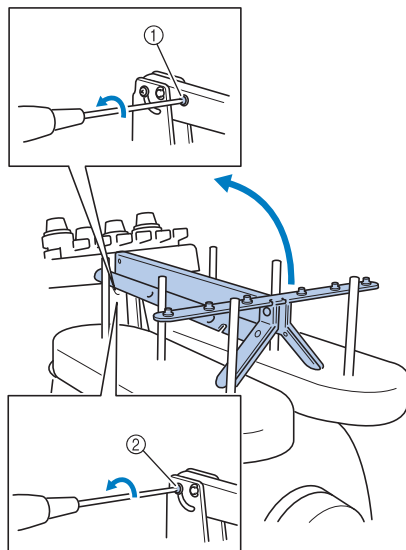
1 Using the included Phillips screwdriver, loosen the two screws on the left side of the thread guide assembly support so that the thread guide assembly can be raised.

- ① Remove the screw.
- ② Turn the screw three or four times to loosen it.

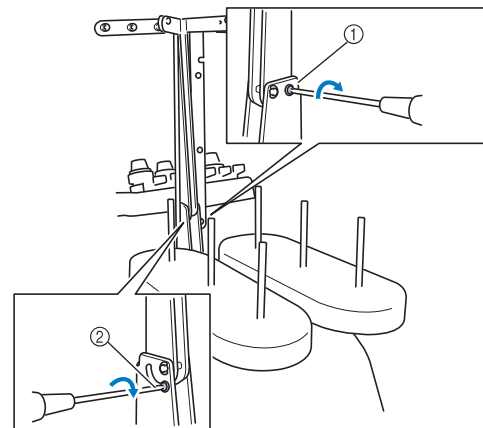
2 Raise thread guide into position and tighten screw ② on the left. Insert screw ① into right side of the thread guide assembly support and tighten.

- ① Insert screw and tighten.
- ② Tighten screw.

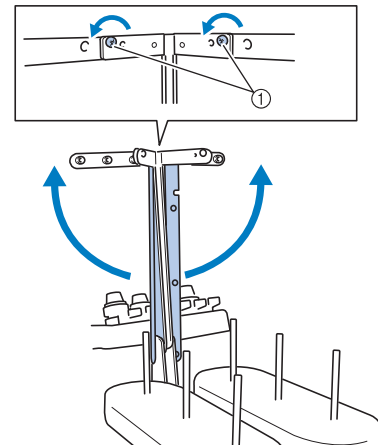
3 Using the Phillips screwdriver, loosen the screws on the left and right sides of the thread guide assembly and lift up the thread guide so that it is level.

- ① Loosen screws.

- 4 Tighten the screws on the left and right sides of the thread guide assembly.

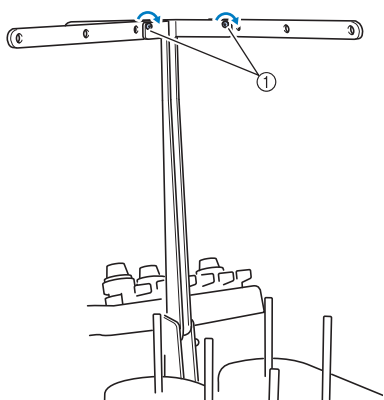

- ① Tighten screws.

Note

- If the screws are not loosened enough, it may not be easy to move the thread guide assembly support and the thread guide. Do not apply extreme force when moving the thread guide assembly support and the thread guide. Be sure that the screws are loosened well enough before moving these parts.
- Be sure to tighten each screw well enough that the thread guide assembly support and the thread guide are secured.

Preparing the spool stand

- 1 Loosen the thumb screw two or three turns, and then open up the spool stand to the left and right.

Rear view

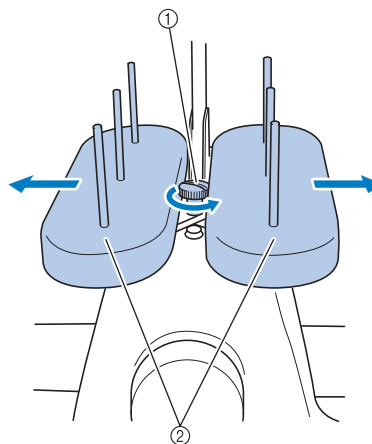

- ① Thumb screw
② Spool stand

Note

- Using the 3-way screwdriver included, loosen and firmly tighten the thumb screws.

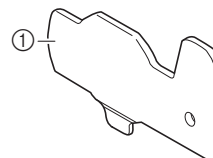

- ① Use this part to tighten the thumb screws of the spool stand.

- 2 After the spool stand is fully opened up, tighten the thumb screw.

Rear view

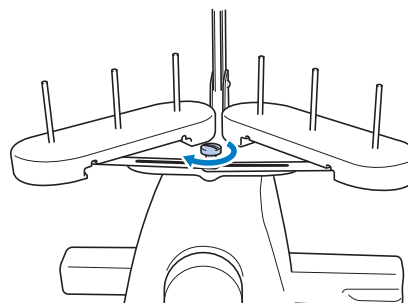

→ Secure the spool stand in the opened position.

Attaching the embroidery frame holder

- 1 Use the embroidery frame holder appropriate for the embroidery frame that you are using. (page 67 to page 70)
- 2 Remove the two thumb screws of the embroidery frame holder.

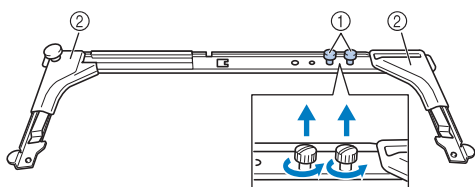

- ① Thumb screws
- ② Corner covers

Note

- Using the 3-way screwdriver included, loosen and firmly tighten the thumb screws.

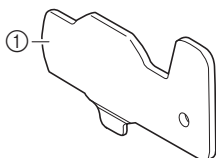

- ① Use this part to tighten the thumb screws of the embroidery frame holder.

- 3 Align the holes in the embroidery frame holder with the pins on the frame-mounting plate of the carriage.

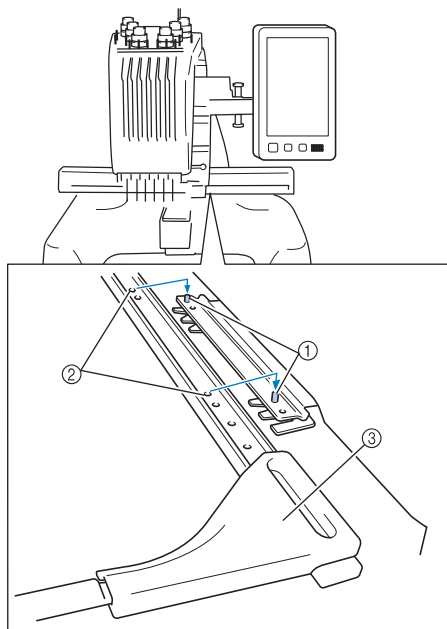

- ① Pins on the frame-mounting plate
- ② Holes in the embroidery frame holder
- ③ Corner covers

Memo

- Each embroidery frame holder has different color of corner cover.
Holder A: White corner covers
Holder B: Light gray corner covers
Holder C: Dark gray corner covers (Optional)

- 4 Secure the embroidery frame holder with the two thumb screws removed in step 2.

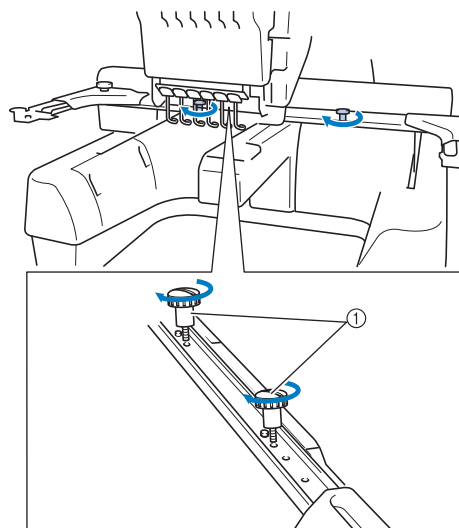

- ① Thumb screws

Note

- Two types of embroidery frame holders are included with this machine. Embroidery frame holder A is used with the four included embroidery frames. (page 67)
- Refer to page 68 for hoops used with frame holder B and other optional frame holders.

This completes the preparation of the machine.

TURNING ON THE MACHINE

⚠ WARNING

- Use only regular household electricity for the power source. Using other power sources may result in fire, electric shock, or damage to the machine.
- Make sure that the plugs on the power supply cord are firmly inserted into the electrical outlet and the power supply cord receptacle on the machine. Otherwise, a fire or electrical shock may result.
- Do not insert the plug on the power supply cord into an electrical outlet that is in poor condition.
- If any of the following occur, turn off the machine and unplug the power supply cord, otherwise a fire, an electric shock or damage to the machine may result.
 - When you are away from the machine.
 - After using the machine.
 - If a power outage occurs while the machine is being operated.
 - If the machine is not operating properly, for example, when there is a loose or cut connection.
 - During electrical storms.

⚠ CAUTION

- Be sure to use the included power cord for this machine.
- Do not plug this machine in with extension cords or multi-plug adapters with any other appliances plugged into them, otherwise a fire or an electric shock may result.
- Do not plug in or unplug the power supply cord with wet hands, otherwise an electric shock may result.
- When unplugging the power supply cord, be sure to first turn off the machine, and then grasp the plug when unplugging the cord. Pulling on the cord may damage it or result in a fire or an electric shock.
- Do not allow the power supply cord to be cut, damaged, modified, forcefully bent, pulled, twisted, or bundled. In addition, do not place heavy objects on the cord or expose it to heat, otherwise damage to the cord, fire or an electric shock may result. If the power supply cord or its plug is damaged, stop using the machine, and then take the machine to your authorized Brother dealer for repairs before continuing use.

- If the machine is not to be used for a long period of time, unplug the power supply cord, otherwise a fire may result.
- For U.S.A. only
This appliance has a polarized plug (one blade wider than the other). To reduce the risk of electrical shock, this plug is intended to fit in a polarized outlet only one way. If the plug does not fit fully in the electrical outlet, reverse the plug. If it still does not fit, contact a qualified electrician to install the proper electrical outlet. Do not modify the plug in any way.

- 1 Insert the power supply cord into the power cord receptacle, then insert the plug into a wall outlet.

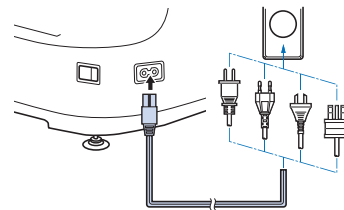

- 2 Switch on the main power switch on the right side of the machine to "I".

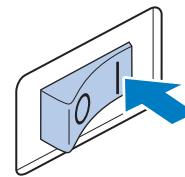

→ The LCD screen comes on.

- 3 When the machine is turned on, the opening movie is played. Touch anywhere on the screen to display the message below.

- 4 Touch .

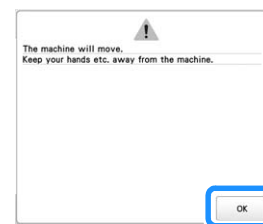

→ The pattern type selection screen appears, and the "Start/Stop" button lights up in red.

- 5** The carriage moves to its initial position.
- If the number 1 needle bar is not already at the embroidering position, the needle bar case moves and the number 1 needle bar moves to the embroidering position.

⚠ CAUTION

- Make sure to keep your hands and other items away from the carriage, in order to prevent any injuries.

- 6** Set the main power switch to "O" to turn off the machine.

📖 Memo

- If the machine is turned off in the middle of embroidering, the machine will automatically save the design position when turned on again. At that time, you will be asked if you wish to continue embroidering or begin a new operation. (page 92)

■ Setting your machine for the first time

When you first turn on the machine, set the language and time/date to your language and local time/date. Follow the procedure below when the settings screen appears automatically.

- 1** Touch and to set your local language and then touch .

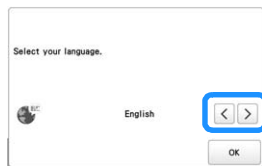

→ The carriage moves to its initial position.

- 2** The message screen, confirming if you want to set time/date, appears. Touch .

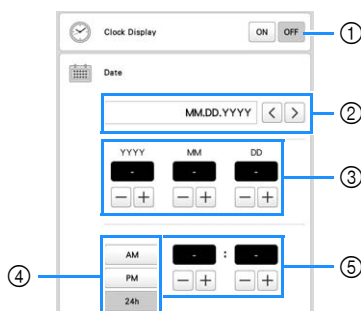

- Select [ON] to display time/date on the screen.
- Touch or to select the date display format.
- Set the year [YYYY], month [MM] and date [DD].
- Select whether 24h or 12h setting to display.
- Set the current time.

- 3** Touch to start using your machine.

→ The clock starts from 0 second of the time you set.

📖 Memo

- The time/date you set may be cleared if you don't turn on the machine for an extended period of time.
- Time setting is also available by touching on the bottom right of the LCD screen.

LCD SCREEN

Touch the LCD screen, or a key, with your finger or the included touch pen to select a machine function.





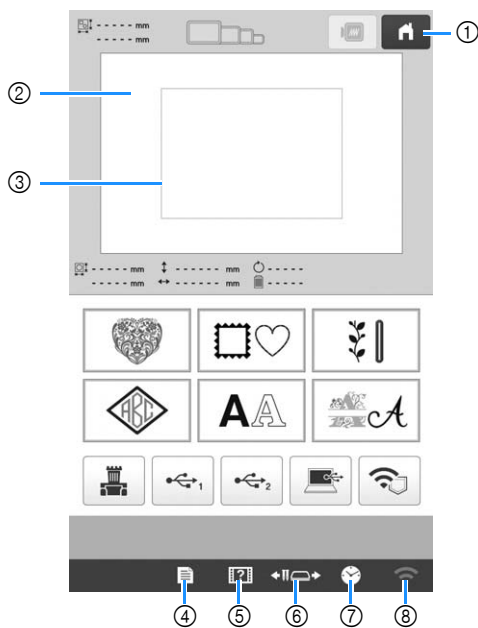

⚠ CAUTION

- Only touch the screen with your finger or the touch pen included with the machine. Do not use a mechanical pencil, screwdriver or any other hard or sharp object. In addition, do not touch the screen with extreme pressure. Otherwise the screen may be damaged.
- All or part of the screen may sometimes become darker or lighter due to changes in the surrounding temperature or other changes in the environment. This is not a sign of a malfunction. If the screen is difficult to read, adjust its brightness.

■ Pattern type selection screen







No.	Display	Function	Page
	Key Name		
①		Cancel all operations previously performed and return to the initial pattern type selection screen.	-
	Home key		
②	-	This area displays the selected pattern.	109
	Pattern display area		



No.	Display	Function	Page
	Key Name		
③	-	Shows the available embroidering area for the attached embroidery frame. The embroidery frame indications, the grid lines and other display settings can be specified from the machine settings screen.	109
	Embroidering area line		
④		Change the machine settings.	25
	Settings key		
⑤		Check a machine operation.	29
	Machine operations guide key		
⑥		Move or thread a selected needle bar, to position the carriage, or to oil the machine so the embroidery frame can easily be removed or attached.	67, 81
	Needle bar/Frame move key		
⑦		Set the clock to your local time.	23
	Clock key		
⑧		Specify the wireless LAN settings. Also, this key shows the machine's wireless LAN signal strength. If there is a new update file, the key appears as  .	27, 158
	Wireless LAN key		

* The keys in the table above appear and can be used in most of the screens described later in this manual.

Using the settings key

Touch  to change the default machine settings (light, volume, speaker volume, opening display etc.). To display the different settings screens, touch  for “Embroidery settings”,  for “General settings”, or  for “Wireless LAN settings”.

Memo

- The machine default setting is highlighted.
- Touch  or  to display the previous or next page.

■ Embroidery settings

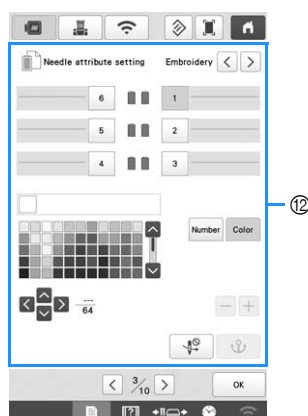
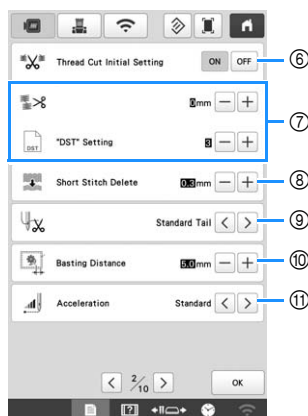
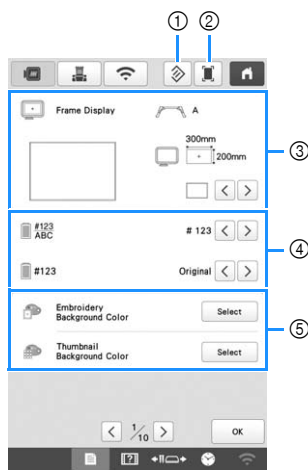

- ① The settings on the page containing this key will be reverted to their defaults.
- ② An image of the current settings screen can be saved on USB media.
- ③ The guides (center point marker and grid) for the pattern display area can be specified. (page 109)
- ④ The color information in the thread color sequence display and the needle bar thread information can be switched to the color name, the thread brand and color number or the embroidering time. (page 109)
- ⑤ Depending on the color of the embroidery, changing the background color of the pattern display area and thumbnails may make them more visible and easier to select.
- ⑥ Selects whether or not jump stitches are trimmed in imported patterns. (page 109)

Memo

- On the pattern editing screen, if the jump stitch trim setting key is selected () , the jump stitches will be trimmed even if [Thread Cut Initial Setting] is set to [OFF]. For details, refer to “Trimming jump stitches” on page 49.
- ⑦ Specifies the jump stitch length. When using Tajima embroidery data (.dst), you can specify whether or not the thread is cut according to the jump codes. (page 109)
 - ⑧ Specifies the length of short stitches that are to be deleted. (page 110)
 - ⑨ Specifies the length of upper thread that remains threaded through the needle after the thread is trimmed (length of thread passed through the eye of the needle). (page 110)
 - ⑩ Specify the distance between the pattern and the basting stitching. (page 110)
 - ⑪ Specifies the acceleration from the initial speed (when embroidery begins) until the maximum embroidery speed is reached.

Memo

- If the setting for [Short Stitch Delete] ⑧ is changed from the previous setting, the new setting is applied to the subsequent embroidery.
- ⑫ A specific thread color can be set to a needle bar. The specified color remains assigned to the needle bar until the setting is canceled. You can also specify the maximum embroidery speed for a needle bar as well as cancel automatic needle threading. This feature is not accessible through the embroidering screen. (page 107)

■ General settings

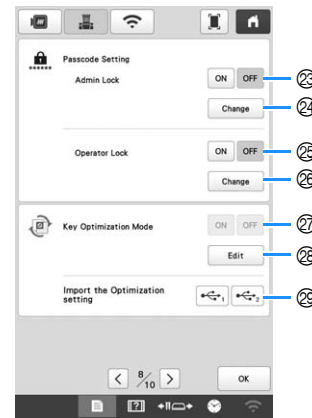
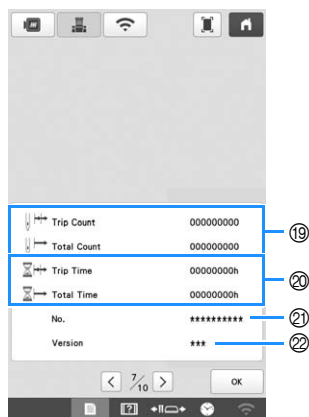
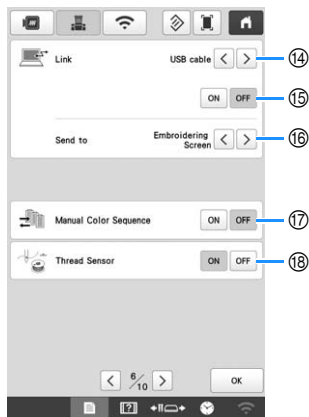
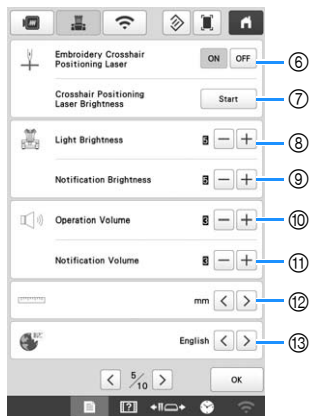
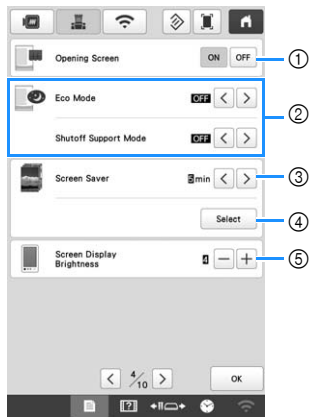

⚠ CAUTION

- When [Thread Sensor] is set to [OFF], the machine cannot detect tangled upper thread. Continuing to use the machine with tangled thread may cause damage.

- ① The machine can be set so that the opening screen is either displayed ([ON]) or not displayed ([OFF]) when the machine is turned on.
 - ② Select settings for the [Eco Mode] and [Shutoff Support Mode]. (page 28)
 - ③ Select the length of time until the screen saver appears.
 - ④ Select the image of the screen saver. (page 28)
 - ⑤ Adjust the brightness of the screen display.
 - ⑥ Set [Embroidery Crosshair Positioning Laser] to [ON] or [OFF].
 - ⑦ Set the brightness of the embroidery crosshair positioning laser. (page 74)
 - ⑧ Adjust the brightness of the embroidery light.
 - ⑨ Adjust the brightness of the embroidery light when lighting effects are used to notify that the thread spool must be changed or an error has occurred.
 - ⑩ Adjust the volume of operation beep. Increase the number for louder volume, decrease for softer volume.
 - ⑪ Adjust the volume of error notification. Increase the number for louder volume, decrease for softer volume.
 - ⑫ Select the display units for embroidering (mm/inch).
 - ⑬ Select the display language. The keys and messages appear in the selected language.
 - ⑭ Set the connection method for the Link mode to USB cable or wireless LAN. (page 117)
 - ⑮ Select the Link function [ON] or [OFF]. (page 117)
 - ⑯ Select in which screen on the machine the embroidery pattern from the computer is received in Link mode. (page 117)
 - ⑰ Set the [Manual Color Sequence] [ON] or [OFF]. (page 60)
 - ⑱ Turn both the upper and bobbin thread sensors [ON] or [OFF]. If it is turned [OFF], the machine can be used without upper thread.
 - ⑲ [Total Count] shows the total number of stitches embroidered, and [Trip Count] shows the number of stitches that have been embroidered since the machine's last maintenance.
 - ⑳ [Total Time] shows the total amount of time that the machine has been used, and [Trip Time] shows the amount of time that the machine has been used since the machine's last maintenance.
- * Use counters ⑲ and ⑳ as a standard for performing periodic maintenance and for scheduling professional maintenance for the machine.

- ⑳ Shows the internal machine number for this machine.
- ㉑ Shows the version of the software installed on this machine.
- ㉒ Set administrator lock to [ON] or [OFF]. (page 129)
- ㉓ The administrator code can be changed. (page 129)
- ㉔ Set operator lock to [ON] or [OFF]. (page 130)
- ㉕ The operator code can be changed. (page 130)
- ㉖ Set key display optimization to [ON] or [OFF]. (page 135)
[ON] or [OFF] cannot be selected when there is no display optimization for the keys.
- ㉗ Optimize display of keys. (page 132)
- ㉘ Recall key display optimization settings saved on USB media. (page 135)

■ Wireless LAN settings

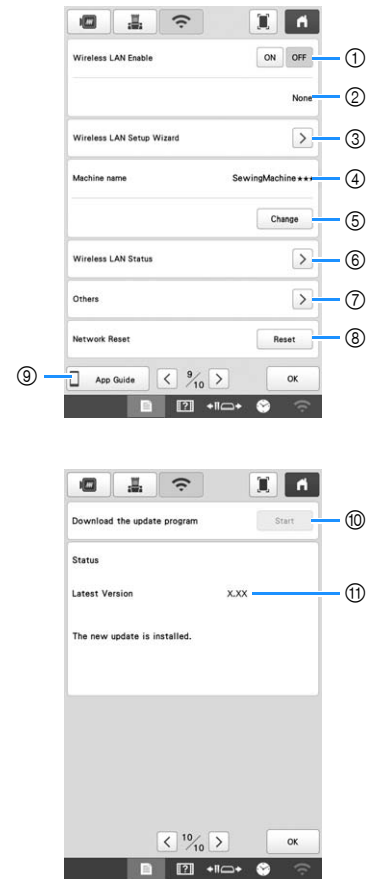

- ① Enable/Disable the wireless LAN function. (page 31)
- ② Shows the connected SSID.
- ③ Set the machine to connect the wireless LAN function. (page 31)
- ④ Shows the machine name used on the wireless LAN function.
- ⑤ Change the machine name used on the wireless network.
- ⑥ Check the wireless LAN status.
- ⑦ Display other menus. (page 33)
- ⑧ Reset network operations.
- ⑨ Display the introduction to the application.
- ⑩ If there is a new program, download the update file. (page 158)
- ⑪ Shows the program information. (page 158)

■ Setting the [Eco Mode] and the [Shutoff Support Mode]

You can save the machine power by setting the [Eco Mode] and the [Shutoff Support Mode]. Touch  to display [Eco Mode] and [Shutoff Support Mode]. (page 26)
If you leave the machine turned on without using it for the set period of time, the machine enters in each mode.

[Eco Mode]:

Machine will enter a sleep mode after the set period of time. Touch the screen or press the “Start/Stop” button to continue operating.

[Shutoff Support Mode]:

Machine will turn off after set period of time. Turn the machine off and then back on to restart operating.

Note



- If you turn off the machine while the machine is in the [Eco Mode] or the [Shutoff Support Mode], wait for about 5 seconds before turning on the machine again.

■ Changing the screen saver image

You can select your own personal images for the screen saver of your machine.

Before changing the screen saver image, prepare the image on your computer or USB media.

For details on compatible image files, refer to “SPECIFICATIONS” on page 156.

- 1 Touch , then .
→ The general settings screen appears.

- 2 Touch in [Screen Saver].

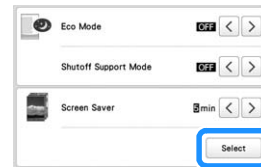

- 3 Touch .

- 4 Connect the USB media or the computer (using a USB cable) that contains your personal image to the USB port of the machine.

- 5 Touch to select the first image.

- 6 Select the device that is connected.

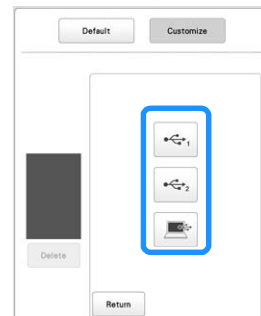

→ A list of your personal images appear on the screen.

- Touch to delete the selected image.
- Touch to return to the previous screen.

- 7 Touch a file name to select image and then touch .

→ The selected image is stored on your machine.

- 8 Repeat steps 5 through 7 to set the remaining images.

- 9 Touch to return to the original screen.

Using the machine help

Touch  to display the machine help screen.
Functions are available from the screen shown below.

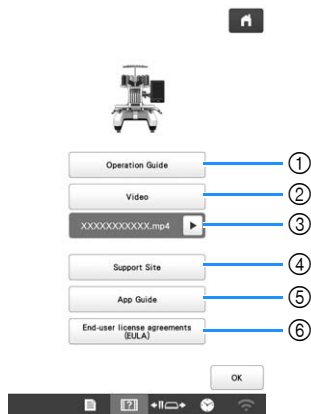

- ① Explanation for upper threading, installing the bobbin, preparing to embroider a pattern, and how to use the machine (page 29)
- ② Tutorial videos or MPEG-4 (MP4) videos from USB media (page 29, page 30)
- ③ Appears immediately before playback of your MP4 video on USB media begins. Touch to resume paused video playback.
- ④ Display the link information to Brother support website.
- ⑤ Display the introduction to the application.
- ⑥ Display the Terms of Use for this machine.

Using the operation guide function

Touch  to display the screen shown below. Categories are displayed at the top of the screen. Touch a key to see more information about that category. Some of the functions are described in the movies. Watch these movies for a better understanding of the functions.



- ① Information about the main parts of the machine and their functions
- ② Information about threading the machine, hooping the fabric in the embroidery frame, etc.
- ③ Information about troubleshooting
- ④ Information about cleaning the machine, etc.

Playing a tutorial video

This machine provides tutorial videos on how to use the machine.

1 Touch .

2 Touch .

3 Select the category and the tutorial video.

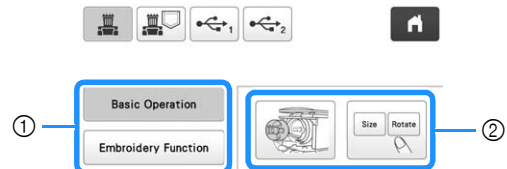





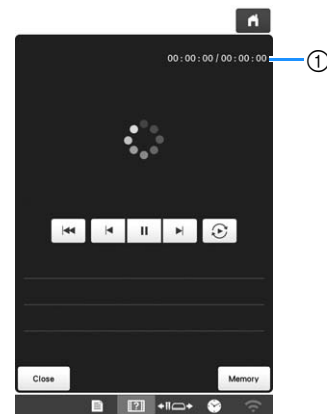



- ① Category
 - ② Tutorial video
- The selected tutorial video begins playing.

4 Play the tutorial video.



- ① Number of seconds elapsed/Total number of seconds

Operation keys

	Play
	Pause
	Skip back 10 seconds
	Skip forward 10 seconds
	Return to beginning
	Repeat
	Delete video (when playing from the machine's memory)
	Save to machine (when playing from USB media)

Memo

- A frequently viewed tutorial video can be saved to  (favorites) of the machine, from where it can be played.

5 After you are finished playing the video, touch .

■ Playing MPEG-4 (MP4) videos

Your MP4 videos can be played from USB media. In addition, the MP4 video can be saved to the machine so that a tutorial video on creating a project, for example, can be viewed at any time. For details on compatible video files, refer to "SPECIFICATIONS" on page 156.

Memo





- Some type of MP4 files cannot be viewed with the machine.

1 Touch .

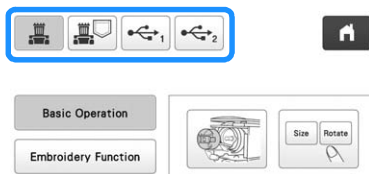
2 Touch .

3 Select the device where the video is saved.



-  : play a tutorial video
-  : Play a video saved on the machine (favorites)
-  : Play a video from USB media plugged into the USB port 1
-  : Play a video from USB media plugged into the USB port 2

4 Select the video that you want to play.

5 Play the video.

- * Use the operation keys as described in "Playing a tutorial video" on page 29.

6 After you are finished playing the video, touch .

WIRELESS NETWORK CONNECTION FUNCTIONS

Operations available with a wireless network connection

This machine supports a wireless network connection. The following useful operations will be available if the machine is connected to a wireless network.

Note

- Connect the machine and your computer or smart device to the same network.
- Conveniently check the operating status of the machine from your smart device by using the dedicated mobile application (My Stitch Monitor). (page 33)



- Directly download the update file to the machine. (page 158)

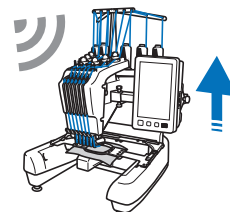

- Wirelessly transfer an embroidery pattern from your computer to the machine by using the dedicated Windows application (Design Database Transfer). The application can be downloaded from the following URL.

<http://s.brother/cabkb/>

- * Settings must be specified in Design Database Transfer. For more information, refer to the manual for Design Database Transfer.

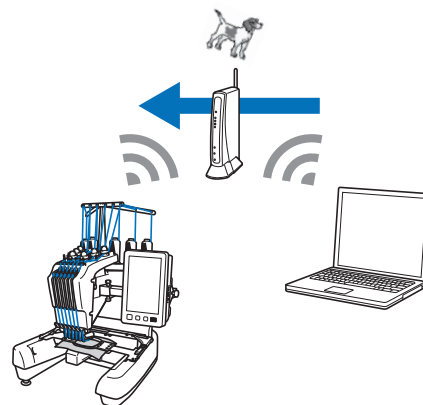

- Wirelessly transfer to the machine an embroidery pattern edited with embroidery editing software (PE-DESIGN version 11 or later) on a computer. Also, transfer to PE-DESIGN an embroidery pattern edited on the machine.
- * Settings must be specified in PE-DESIGN. For more information, refer to the manual for PE-DESIGN.

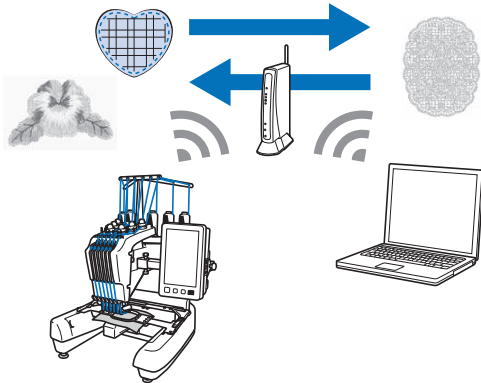

- Using the Wireless Link function, wirelessly transfer to the machine an embroidery pattern edited with embroidery editing software (PE-DESIGN version 11.2 or later) on a computer. Also, check the embroidering status of the machine from the computer. (page 117)
- * Settings for the Wireless Link function must be specified on the machine and in PE-DESIGN. For details, refer to "SENDING EMBROIDERY PATTERNS FROM A COMPUTER TO THE MACHINE (LINK FUNCTION)" on page 117 and to the manual for PE-DESIGN.

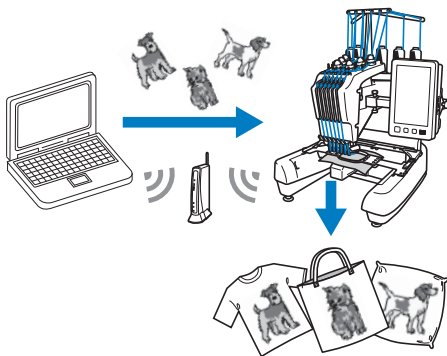

Enabling a wireless network connection

The machine can be connected to your wireless network.

- 1 Touch .



→ The wireless LAN settings screen appears.

- 2 Set [Wireless LAN Enable] to [ON].

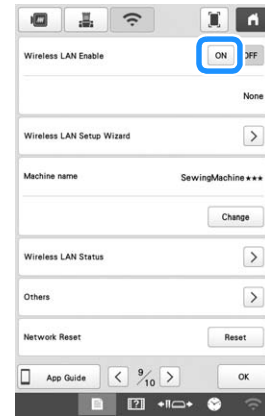

→ The machine prepares for wireless transmission.

Requirements for a wireless network connection

The wireless network connection complies with IEEE 802.11 b/g/n standards and uses the 2.4 GHz frequency.

Memo

- A wireless network cannot be set up with WPA/WPA2 Enterprise.

Setting up the wireless network connection

There are multiple ways to set up the wireless network connection. We recommend the method that uses the wizard on this machine.

Using the wizard to set up the wireless network connection

- 1 In order to connect your machine to a wireless network, the security information (SSID and network key) for your network will be required. The network key may also be called a password, security key or encryption key. Find your security information and note it in the table below.

SSID	Network Key (Password)

Memo

- The wireless network connection cannot be set up if you do not have the security information.
- How to find the security information
 - ① Check the manual provided with your network.
 - ② The default SSID may be the manufacturer's name or the model name.
 - ③ If you cannot find the security information, contact the manufacturer of the router, your network administrator or your Internet provider.
 - ④ SSIDs and network keys (passwords) may be case-sensitive.

2 Touch > beside [Wireless LAN Setup Wizard].

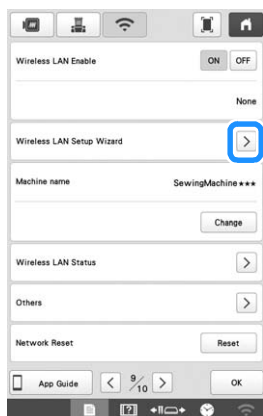

→ A list of available SSIDs appears.

3 Touch > beside the SSID that was noted.

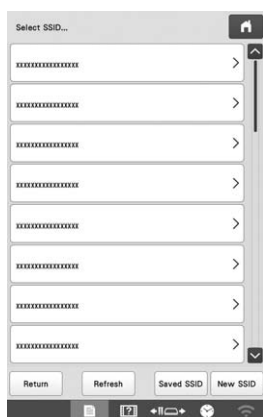

→ The screen for entering the network key (password) appears.

Memo

- If the SSID that was noted does not appear in the list, touch .
- If the SSID that was noted is not displayed, specify it as described below.
 - ① Touch .
 - ② Enter the desired SSID, and then touch .
 - ③ Select the authentication method and encryption mode.
- If the machine had already been connected to the network, touch , and then select the saved SSID.

4 Enter the network key (password) that was noted, and then touch .



5 When the following message appears, touch .

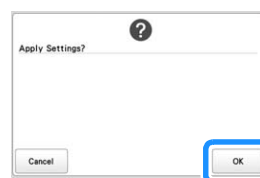

→ When a connection is established, the following message appears.

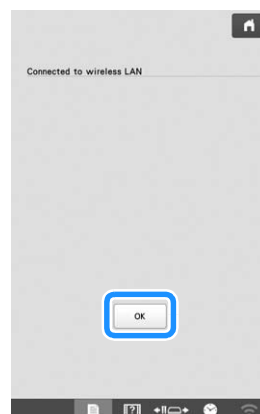

- 6 Touch **OK** to exit the setup.

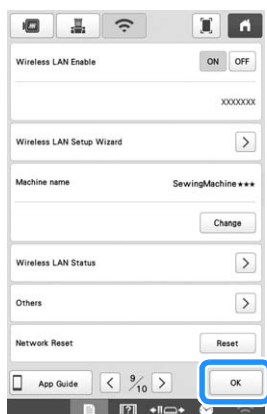

Memo

- While connected, the signal strength is indicated by the icon in the lower-right corner of the display.
- Once a wireless network connection has been set up, a connection will be established each time the machine is turned on. However, [Wireless LAN Enable] in the network settings screen must remain set to [ON].

Using the [Others] menu to set up the wireless network connection

The [Others] menu contains the following items.

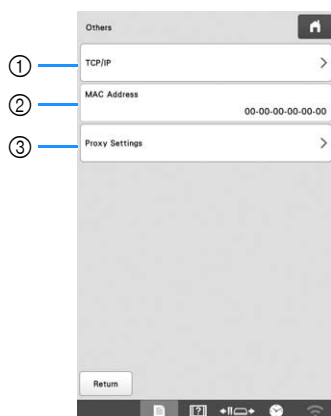

- 1 TCP/IP settings can be manually entered.
- 2 Shows the MAC address.
- 3 Use when proxy settings are required.

MONITORING APP

With the monitoring app installed on your smart device and the machine and smart device connected to the same wireless network, you can check the operating status of the machine. You can also check when to change the thread spool and what thread spool color to change to. In addition, you can receive notifications when the machine stops.

Installing App

- 1 Use your smart device to visit the Google Play™ or App Store.



Google Play™



App Store

- 2 Install [My Stitch Monitor] to monitor embroidering.



My Stitch Monitor

Memo

- To download and install the app, you can also search for [My Stitch Monitor] in Google Play™ or the App Store.
- Visit the following web site for support information on the app.
<http://s.brother/cpban/>

Monitoring

Memo

- The app will be updated from time to time. The following descriptions may differ from the actual screens and operations.

- 1 Connect the machine to your wireless network. (page 30)
- 2 Confirm that your smart device and your machine are connected to the same network.
- 3 Touch the icon for [My Stitch Monitor] on the smart device to start the app.
- 4 Follow the instructions that appear in the app to connect the app to your machine.

* Select the name that appears beside [Machine name] in the wireless LAN settings screen on your machine.

→ The machine can now be monitored.

Chapter 2 BASIC EMBROIDERY

2

BASIC PROCEDURES

Basic embroidering procedures are described below. Check the overall procedure below, before operating the machine.

Step	Operation	Reference Page
1	Install the bobbin.	35
2	Turn on the machine.	22
3	Select an embroidery pattern.	37
4	Edit the embroidery pattern.	46
5	Check the previewed image.	61
6	Hoop the fabric in the embroidery frame.	63
7	Attach the embroidery frame to the machine.	66
8	Specify the embroidering settings.	70
9	Check the embroidery area.	74
10	Thread the upper threads.	76
11	Touch the "Start/Stop" button to start embroidering. (Once embroidering is completed, the machine automatically stops.)	82
12	Remove the embroidery frame.	86
13	Turn off the machine.	23

INSTALLING THE BOBBIN

When the machine is purchased, only the bobbin case is installed in the hook. Insert a bobbin wound with bobbin thread for embroidering.

⚠ CAUTION

- Be sure to use prewound bobbins (Fil-Tec/TRU-SEW POLYESTER "Filaments") or metal bobbins designed specifically for this machine.
- When winding a bobbin, use optional bobbin winder (page 123) and metal bobbins.

💡 Note

- Before starting to embroider make sure that there is enough bobbin thread for the pattern.
- Make sure to clean the bobbin case every time the bobbin is changed. (page 139)

Removing the bobbin case

- 1 **Open the hook cover.**
Pull the hook cover toward you.

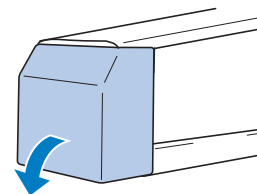

- 2 **Pull the thread picker toward you if it was not pulled toward the front.**

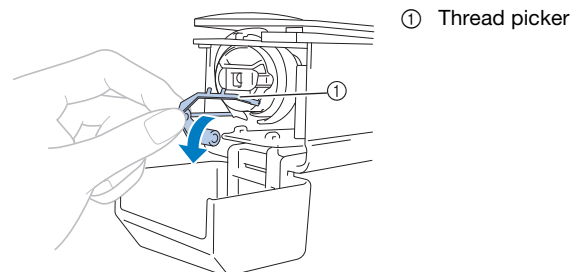

To gain access to the bobbin case easily, pull the thread picker toward front.

📝 Memo

- Thread picker is a device that is used to hold the thread when beginning to embroider or when trimming the thread.

⚠ CAUTION

- The thread picker can only be moved within a certain range. Do not pull it with extreme force.

- 3 Grab the bobbin case latch, and remove the bobbin case.

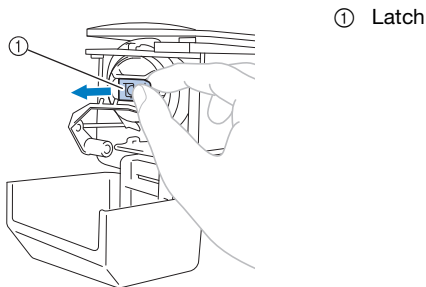

■ Oiling the machine

After removing the bobbin case, apply oil to the machine. You need to apply oil onto the race hook. For details on oiling the machine, refer to “Oiling the machine” on page 142.

💡 Note

- Put a drop of oil onto the hook once a day before use.

Installing the bobbin

- 1 Insert the bobbin into the bobbin case.

- Prewound bobbin

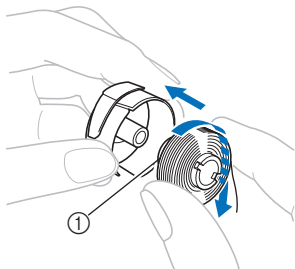

- Metal bobbin (page 123)

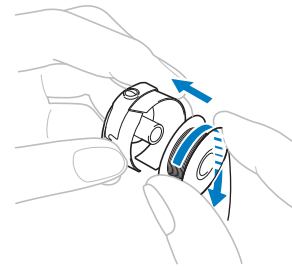

💡 Note

- Check that the thread winds off the bobbin clockwise as shown in the illustration. If the bobbin is installed with the thread winding off in the opposite direction, the embroidery will not be stitched correctly.

- 2 Pass the thread through the thread slit and under the tension-adjusting spring.

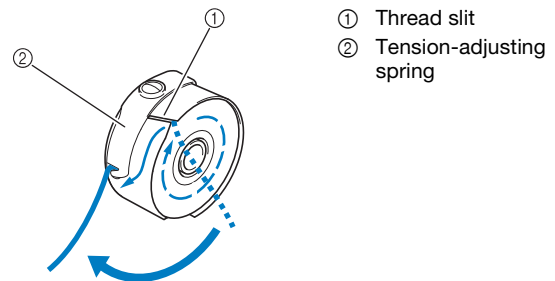

- 3 Pull the thread through the opening in the tension-adjusting spring.

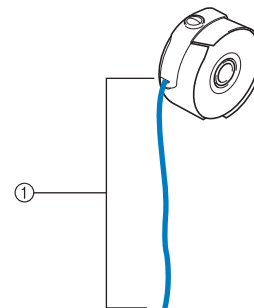

- ① About 5 cm (2 inches).

- For details, refer to “Adjusting the tension of the bobbin thread” on page 102.

Installing the bobbin case

1 Insert the bobbin case into the hook.

Insert the bobbin case while aligning the tab on the bobbin case with the notch in the hook, as shown in the illustration.

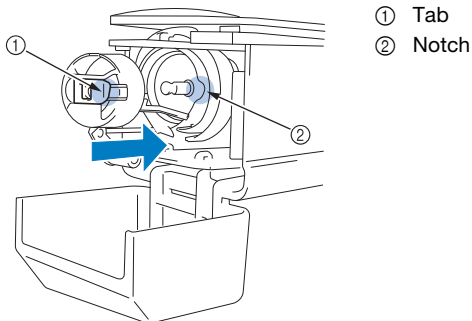

- Fully insert the bobbin case until it snaps into place.

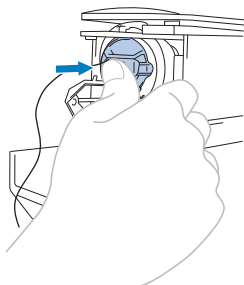

2 Close the hook cover.

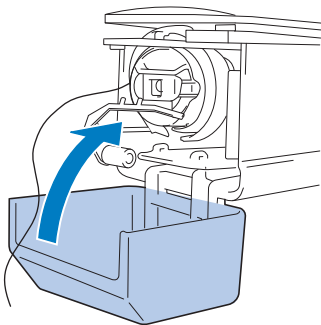

SELECTING AN EMBROIDERY PATTERN

General pattern selection

The procedure for selecting a pattern differs depending on the type of pattern; however, the general procedure for selecting a pattern is described below.

1 In the pattern type selection screen, touch the key for the desired category.

■ Pattern type selection screen

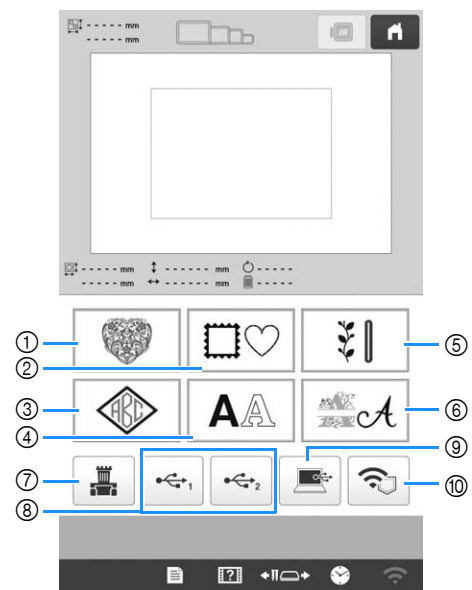

- ① Embroidery patterns (page 38)
- ② Frame patterns (page 39)
- ③ Monogram and frame patterns (page 40)
- ④ Character patterns (page 41)
- ⑤ Utility embroidery patterns/Large buttonhole patterns (page 39)
- ⑥ Decorative alphabet patterns (page 43)
- ⑦ Patterns stored in the machine's memory (page 116)
- ⑧ Patterns saved on USB media (page 116)
- ⑨ Patterns saved on a computer (page 116)
- ⑩ Patterns to be transferred via the wireless network (page 116)

2 In the pattern category list screen, which appears next, touch the desired pattern category to select it.

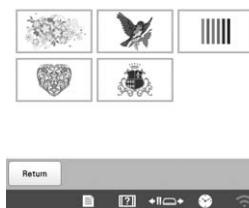

3 In the pattern list screen, which appears next, touch the desired pattern to select it.

■ Pattern list screen

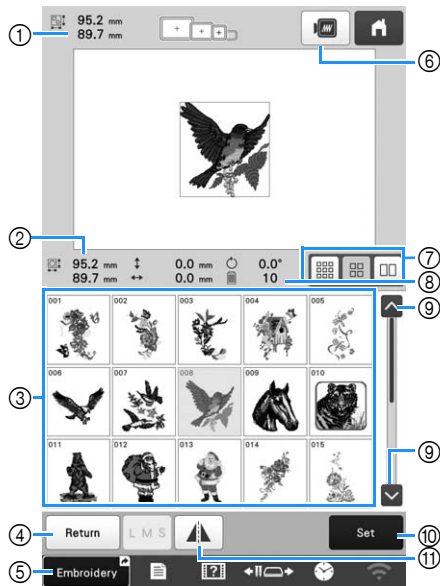

- ① Size of the entire combined pattern
- ② Size of the pattern being selected
- ③ Touch a pattern to display the information of the pattern.
- ④ Return to pattern category list screen to change category.
- ⑤ Shortcut to the embroidering screen.
- ⑥ Preview the embroidery image.
- ⑦ Select the size of pattern thumbnails from small, medium and large sizes.
- ⑧ Number of thread color changes
- ⑨ Touch until the desired page is displayed if there is more than one page.
- ⑩ Confirm the pattern, and move to the pattern editing screen.
- ⑪ Flip the pattern being edited horizontally.

Embroidery patterns

1 Touch .

2 Select an embroidery pattern category.



→ The list of embroidery patterns appears.

3 Select an embroidery pattern.

→ The selected pattern appears in the pattern display area.

4 Touch .

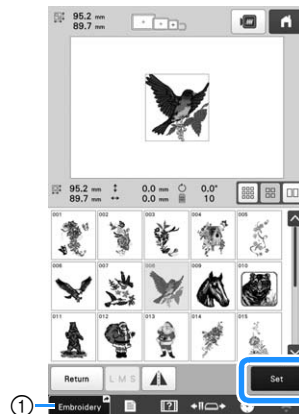

① If no pattern editing is necessary, touch . This takes you to the embroidering screen (illustrated in 11).
→ The pattern editing screen appears.

5 Edit the selected pattern. (page 46)



① When editing is completed, touch . This takes you to the embroidering screen (illustrated in 11).

6 Hoop the stabilizer and fabric in the embroidery frame. (page 63)

7 Attach the embroidery frame to the machine. (page 66)

8 Touch .

→ The embroidering settings screen appears.

9 Edit the entire pattern. (page 70)

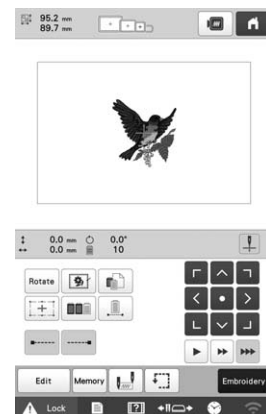

- 10 Touch **Embroidery**.
→ The embroidering screen appears.
- 11 Check the embroidering screen and thread the upper threads. (page 76)



- 12 Start embroidering. (page 82)

Frame patterns

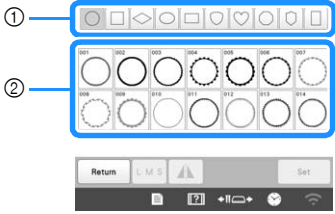
- 1 Touch .
 - 2 From the upper tabs, select the desired frame shape.
→ Frame patterns appear below.
- 
- The screenshot shows a selection screen for frame patterns. At the top, there are two rows of icons. The first row contains various frame shapes (square, circle, etc.), with the first icon circled in blue and labeled '1'. The second row contains various frame patterns (solid, dashed, etc.), with the first icon circled in blue and labeled '2'. Below the icons is a control panel with 'Return', 'L M S', and 'Set' buttons.
- ① Frame shapes
 - ② Frame patterns
- 3 Touch the desired frame pattern.
→ The selected pattern appears in the pattern display area.
 - 4 Touch **Set**.
→ The pattern editing screen appears.
 - 5 Follow the procedure from step 5 to 12 of "Embroidery patterns" on page 38.

Utility embroidery patterns/Large buttonhole patterns

- 1 Touch .
- 2 Select the desired category of the utility embroidery patterns or the large buttonhole patterns.



→ The list of patterns of the selected category appears.

- 3 Select a pattern.
→ The selected pattern appears in the pattern display area.
- 4 If necessary, edit the pattern.

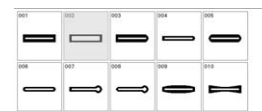

- ① Large buttonhole patterns can be selected from small, medium and large sizes.
- ② Flip the pattern horizontally.

- 5 Touch **Set**.
→ The pattern editing screen appears.
- 6 Follow the procedure from step 5 to 12 of "Embroidery patterns" on page 38.

Monogram and frame designs

Monogram designs can be created by combining two or three letters.

1 Touch .

2 Touch the button for the desired character style.

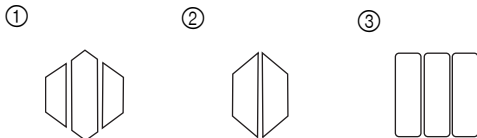
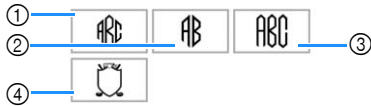

→ The text input screen appears.

- If ④ is selected, the frame pattern list appears. When creating a pattern by combining letters with a frame, it does not matter which of the two, the letters or the frame, is selected first. The embroidering order follows the order in which the parts of the monogram are selected. For this example, we will select the letters first.

3 Select the characters.

Touch the tabs to select different character shapes, and then touch the key for one letter on each tab.

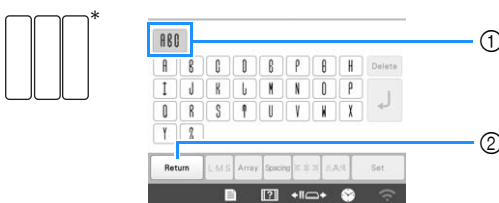

* Since the shapes of the letters are the same with this design, there are no tabs to select.

- ① Tabs
- ② To change the character font, touch  to return to the design selection screen.

→ The selected characters appear in the text preview area and the pattern display area.

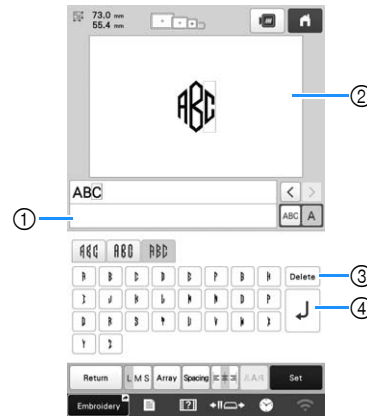

- ① Text preview area
- ② Pattern display area
- ③ If the wrong character was selected or you wish to select a different character, touch  to delete the last character selected, and then touch the desired character.
- ④ Line feed key

Memo

- Depending on the monogram style, there is a preset number of letters; however, more than the preset number of letters can be entered. If too many letters are selected, touch  to delete the letters.
- If desired, multiple letters can be selected to use these characters in the same way as any other character pattern without creating a monogram.

4 If necessary, edit the characters. (page 42)



- ① Select to edit all characters or one character.
- ② Change the size of the characters.
- ③ Change the text arrangement.
- ④ Change the spacing of the character patterns.
- ⑤ Change the text alignment.

5 Touch .

→ The pattern editing screen appears. Next, we will combine the letters with a frame.

6 Touch **Add**.



→ The pattern type selection screen appears.

7 Touch .

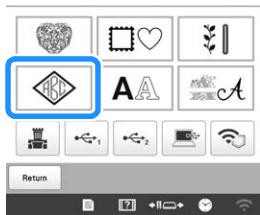

→ The design selection screen appears.

8 Touch .



→ The list of frame patterns appears.

9 Touch the desired pattern.

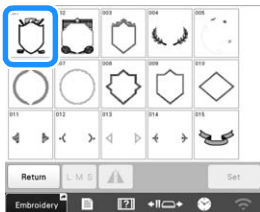

→ The selected frame pattern appears in the pattern display area.

10 Touch **Set**.

→ The pattern editing screen appears.

 **Memo**

- Due to size or shape, some frame patterns cannot be used with the  design.
- The frame patterns are just some of the patterns that can be used. Character patterns other than the 3-letter monogram patterns can be used in the combination.



11 Follow the procedure from step 5 to 12 of “Embroidery patterns” on page 38.

Character patterns

1 Touch **AA**.

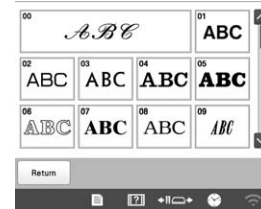
2 Touch the desired character font.



- Touch  or  for additional selections.
- The text input screen appears.

3 Select the character category and then select the characters. (page 42)

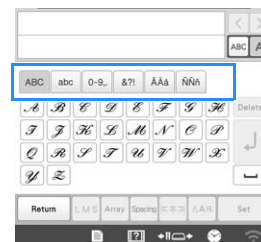

4 Touch **Set**.

→ The pattern editing screen appears.

5 Follow the procedure from step 5 to 12 of “Embroidery patterns” on page 38.

2

Character pattern input keys

Memo

- If a key display is grayed out, you cannot use that function with the selected pattern.

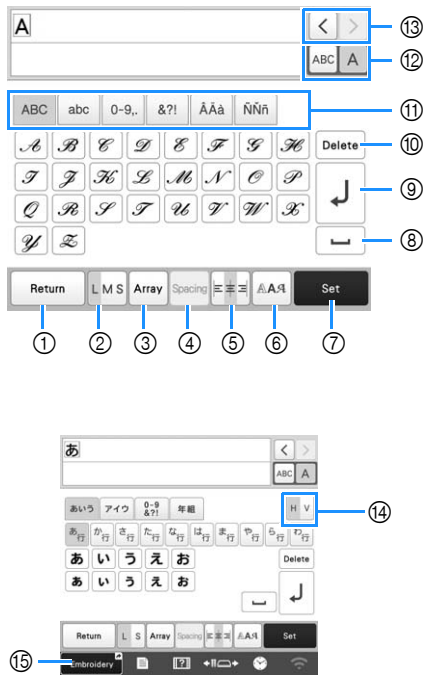

No.	Display	Function
	Key Name	
①		Return to the previous screen.
	Return key	
②		Change the size of the character patterns. To change the size of one character, touch to display and then select the character. The size of the selected character is changed.
	Size key	
③		Change the layout of the character patterns.
	Array key	
		<ul style="list-style-type: none"> To arrange the character patterns on an arc, touch , , or . : Make the arc flatter. : Make the arc rounder. To arrange the character patterns on an incline, touch . : Change the incline counterclockwise. : Change the incline clockwise. : Reset the layout.

No.	Display	Function
	Key Name	
④		Change the spacing of the character patterns.
	Character spacing key	
		<ul style="list-style-type: none"> : Increase the character spacing. : Decrease the character spacing. To change the spacing after one character, touch to display and then select the character. The spacing between the selected character and the next character is changed.
		<p> ABCD E ⇄ ABCDE</p> <p> A B C D E ⇄ ABCDE</p> <p> </p> <ul style="list-style-type: none"> : Move the one selected character up. : Move the one selected character down. : Reset the spacing.
⑤		Switch alignment. This function is available when multiple lines of characters are input.
	Alignment key	
		<ul style="list-style-type: none"> : Right alignment <p style="text-align: right;">ABCDE FGH IJKLMN</p> <ul style="list-style-type: none"> : Left alignment <p style="text-align: left;">ABCDE FGH IJKLMN</p> <ul style="list-style-type: none"> : Center alignment <p style="text-align: center;">ABCDE FGH IJKLMN</p>
⑥		Change the font of the characters. Depending on the font that was selected, it may not be possible to change the font.
	Font type key	
		<ul style="list-style-type: none"> To change the font of one character, touch to display and then select the character. The font of the selected character is changed.

No.	Display	Function
	Key Name	
⑦		Apply the character pattern editing to go to the editing screen.
	Set key	
⑧		Enter a space.
	Space key	
⑨		Make a new line.
	Line feed key	
⑩		Delete the character.
	Delete key	
⑪	—	Select the category of character.
	Category keys	
⑫		Select to edit all characters or one character. <ul style="list-style-type: none"> : Edit all characters. : Edit one character.
	Select one/all key	
⑬		Move the cursor and select a character.
	Character selection keys	
⑭		Switch between text written vertically and horizontally. (Japanese font only)
	Vertical/horizontal text key	
⑮		Shortcut to the embroidering screen.
	Shortcut key	

Decorative alphabet patterns

1 Touch .

2 Touch the desired category.

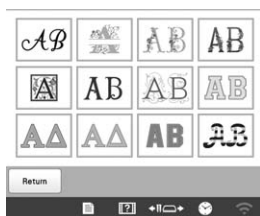

3 Touch the desired pattern.

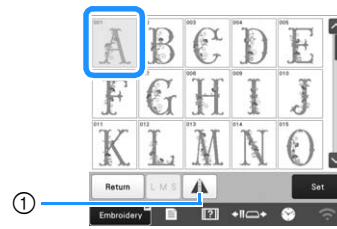

① Flip the pattern horizontally, if desired.
→ The selected pattern appears in the pattern display area.

4 Touch .

→ The pattern editing screen appears.

5 Follow the procedure from step 5 to 12 of “Embroidery patterns” on page 38.

■ Appliqué alphabet

1 Touch .

2 Touch .

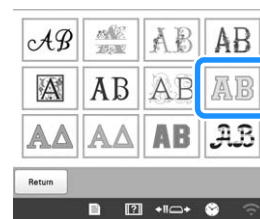

→ The list of appliqué alphabets appears.

3 Touch the desired pattern.

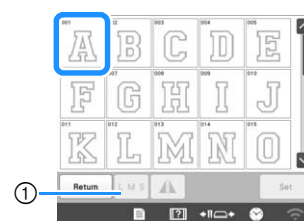

① Change the character size.
→ The selected pattern appears in the pattern display area.

4 Touch .

→ The pattern editing screen appears.

Note

- For details on embroidering appliqués, refer to “Embroidering appliqué patterns” on page 94.

Combining patterns

Example:



1 Select a pattern and then touch **Set**.

2 Touch **Add**.

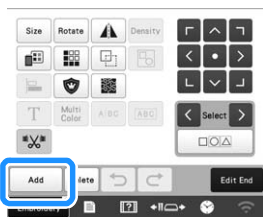

3 Touch **AA**.

4 Select **ABC** and enter "LOVE".

→ The characters you enter will be displayed in the center of the embroidery pattern area.

5 Touch **Set**.

6 Use  to move the characters.

* Characters can also be moved by directly dragging them with your finger or the touch pen.

7 Touch  to change the color of the characters. (page 55)



8 Touch **OK**.

9 When all editing is finished, touch **Edit End**.

Memo

- Combined patterns will be embroidered in the order they were entered.

■ Selecting the pattern to be edited

If multiple patterns have been combined, use **<** or **>** to select the pattern to be edited. Patterns can also be selected by directly touching the screen with your finger or touch pen.

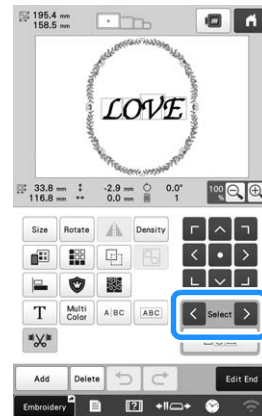

■ Selecting multiple patterns at the same time

Multiple patterns can easily be edited, for example, when moving patterns that are combined, if they are all selected together.

1 Touch .



→ The multiple selection screen appears.

- 2 Select the multiple patterns by dragging your finger in the screen to create a box around the desired patterns.

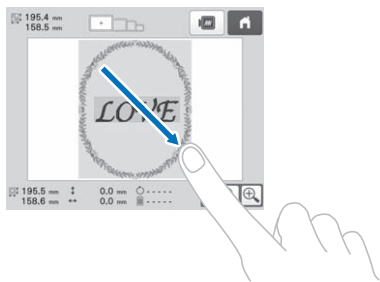

Memo

- Multiple patterns can be selected or deselected from the multiple selection screen. Touch **<** or **>** to check the patterns to be selected, and then touch **Set**.

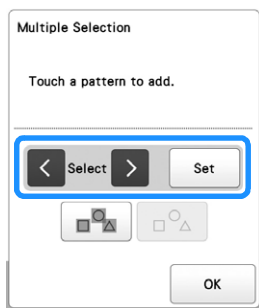

The selected pattern is surrounded with a red box.

- Touch to select all patterns in the pattern display area.
- Touch to deselect all selected patterns.
- The patterns can also be selected by touching them in the screen.
- While the multiple selection screen is displayed, patterns can be moved with .

- 3 Touch **OK** to return to the pattern editing screen.

- The multiple selected patterns are surrounded with a red box.

■ **Grouping multiple selected patterns**

If the multiple patterns selected in “Selecting multiple patterns at the same time” on page 44 are grouped, they can be edited as a single pattern.

- 1 Touch .

→ The selected patterns are grouped.



- Touch to ungroup the patterns. If there are multiple grouped patterns, the selected pattern group is ungrouped.

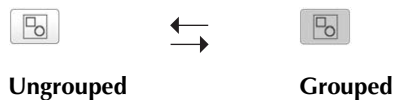



EDITING THE EMBROIDERY PATTERN



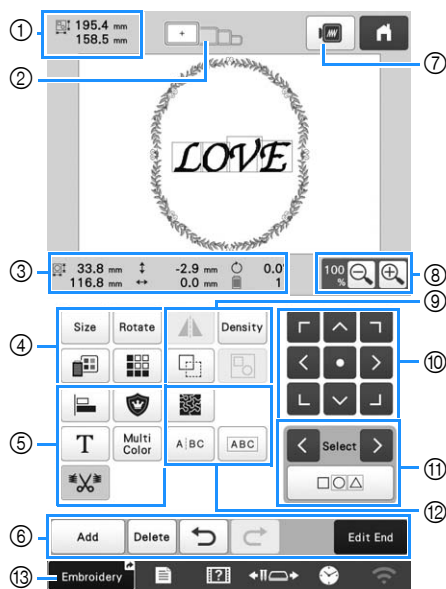

Understanding the pattern editing screen



















Memo













- If a key display is grayed out, you cannot use that function with the selected pattern.



No.	Display	Function	Page
	Key Name		
①	 Pattern size	Shows the size of the embroidery pattern currently displayed in the pattern display area. The top value shows the height and the bottom value shows the width. If the embroidery pattern consists of multiple patterns that have been combined, the size will include all patterns.	—
②	 Embroidery frame indicators	Shows the sizes of embroidery frames that can be used to embroider the pattern currently displayed in the pattern display area.	63

No.	Display	Function	Page
	Key Name		
③	 Size	Shows the size of the pattern being edited. The top value shows the height and the bottom value shows the width.	—
	 Distance from center (vertical)	Shows the vertical distance that the pattern being edited is moved.	—
	 Distance from center (horizontal)	Shows the horizontal distance that the pattern being edited is moved.	—
	 Rotation angle	Shows the rotation angle that the pattern being edited is rotated.	—
	 Number of thread colors	Shows the total number of thread colors for the pattern that is being edited.	—

No.	Display Key Name	Function	Page
④		Display the pattern sizing window.	-
	Size key	<ul style="list-style-type: none"> : Decrease the pattern proportionately. : Decrease the pattern vertically. : Decrease the pattern horizontally. : Enlarge the pattern proportionately. : Stretch the pattern vertically. : Stretch the pattern horizontally. : Change the pattern size while maintaining the number of stitches. (normal resizing mode) : Change the pattern size while maintaining the thread density. (stitch recalculation mode) : Select the pattern that you want to change. : Move the pattern in the direction shown by the arrow. : Reset the size. : Close this screen. : Change the size of the pattern (character patterns only). 	
		Display the pattern rotating window.	
	Rotate key	<ul style="list-style-type: none"> : Reset the angle. Rotate the pattern using the rotate keys or by dragging the red point at the corner of the pattern. You can also use the move keys during the rotation process.	
		Change the color of the pattern.	55
		Make and edit the repeated pattern.	51

No.	Display Key Name	Function	Page
⑤		Arrange multiple patterns on a line.	51
	Alignment key		
		Change the pattern being edited into an appliqué pattern.	95
	Embroidery appliqué key		
		Edit characters.	48
	Letter Edit key		
		Enable the thread color of each character in a character pattern to be changed; can only be used when a character is selected.	55
	Multi color key		
⑥		Select whether or not jump stitches in the selected pattern will be trimmed.	49
	Jump stitch trim setting key		
		Add a pattern. If touched, the pattern type selection screen appears.	44
	Add key		
		Deletes the pattern. If touched, the pattern being edited is deleted.	-
	Delete key		
		Undo the last operation that was performed and return to the previous state. Each touch of this key will undo one operation.	-
	Undo key		
		Redo the operation that was undone.	-
	Redo key		
⑦		Finish editing and continue to the embroidering settings screen.	-
	Edit end key		
⑧		Display an image of the pattern so that it can be previewed.	-
	Preview key		
⑧		Select from 100%, 125%, 150% or 200% to adjust how the pattern being edited is displayed.	-
	Enlarge key		

No.	Display	Function	Page
	Key Name		
⑨		Change the pattern to a horizontal mirror image.	—
	Horizontal mirror image key		
		Change thread density for some character and frame patterns. Other patterns' density can be adjusted in the stitch recalcuator mode.	50
	Density key		
		Duplicate the pattern. The duplicated pattern will be positioned slightly lower and to the right from the original pattern.	—
Duplicate key			
	Group selected multiple patterns.	45	
Group key			
⑩		<ul style="list-style-type: none"> : Move the pattern in the direction shown by the arrow. : Move to the center of the embroidering area. 	44
	Positioning keys		
⑪		Selects the pattern that is being edited when the embroidery pattern consists of multiple patterns that have been combined.	44
	Pattern selection keys		
⑫		Choose multiple patterns to be edited at the same time.	44
	Multiple selection key		
⑬		Create stippling or echo quilting around the pattern.	98
		Separate the continuous character patterns to adjust the spacing or edit separately afterwards. <ul style="list-style-type: none"> : Select where the patterns is to be separated. : Separate the pattern. A separated character pattern can be combined by using . 	—
	Text dividing key		
		Combine the selected character patterns.	50
Text combining key			
⑭		Shortcut to the embroidering screen.	38
	Shortcut key		

■ Editing letters

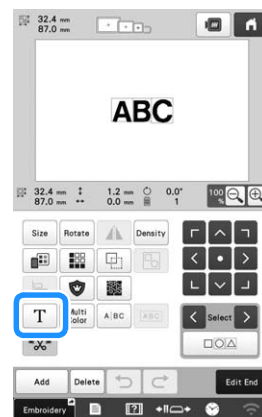

For details on input keys, refer to page 42.

Memo

- To edit character patterns with multiple lines in the edit screen, ungroup the pattern. (page 45)



Changing the size and the density of the pattern

There are two methods to change the pattern size.

If  is selected, you can change the pattern size while maintaining the thread density. The machine recalculates the number of stitches automatically. With this function, the pattern can be enlarged or reduced at a larger ratio than with normal pattern resizing.

Memo

- This function cannot be used with character patterns, frame patterns, repeated patterns or large buttonhole patterns.
- Patterns with a large number of stitches (100,001 or more) cannot be resized while maintaining a thread density.
- Depending on the pattern, the size of the pattern increases up to 200% or reduces to 60%.
- You can also change the size by dragging the red point around the pattern.

1 Touch  to select  or .

*  : Change the pattern size while maintaining the number of stitches. The thread density for the pattern increases or decreases.

*  : Change the pattern size while maintaining the thread density. After the pattern size is changed, the thread density can be changed. The number of stitches is recalculated depending on the pattern size.

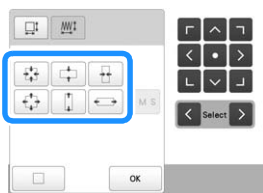

2 When you select  in step 1, the message to reset the pattern to its original size, angle and position will appear. Touch .

3 Touch each key to change the pattern size, as desired.



4 Touch .

Memo

- After resizing pattern using  function in step 1, by touching  in the edit screen, you can adjust the thread density, if desired.

Trimming jump stitches

When jump stitches are set to be trimmed, embroidering will no longer need to be cleaned up after stitching. However, the embroidering time will increase since the jump stitches will be trimmed.

You can select whether or not jump stitches in the selected pattern will be trimmed.

1 Select the pattern whose jump stitches are to be trimmed.

2 Make sure that the jump stitch trim setting key appears as .



- Each touch of the key turns the setting either on or off.







Threads are trimmed.

Threads are not trimmed.

- On the pattern editing screen, if the jump stitch trim setting key is selected () , the jump stitches will be trimmed even if [Thread Cut Initial Setting] is set to [OFF].

Memo

- As you combine patterns, you can select whether or not jump stitches will be trimmed for each pattern.
- If you have selected multiple patterns, and the patterns include some whose jump stitches will be trimmed () and some whose jump stitches will not be trimmed () , the jump stitch trim setting key for the combined patterns appears as () . For details on selecting multiple patterns, refer to “Selecting multiple patterns at the same time” on page 44.
- Touch () to apply the setting the same as for [Thread Cut Initial Setting] in the settings screen for all patterns.

Trimming jump stitches between characters

The lengths of jump stitches between characters (from the end point of one character to the start point of the next character) differ depending on the font used and the character spacing. If the length is longer than the specified setting for trimming jump stitches, jump stitch trimming is performed. For details on specifying the length for trimming jump stitches, refer to page 110.

Example:

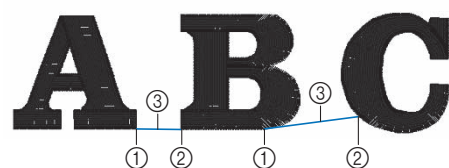

- ① End point
- ② Start point
- ③ Length of jump stitch

Combining the separated character patterns

Two separated lines of character patterns can be combined. The characters can be aligned to the specified order. You cannot combine the lines of character patterns if the text contains a line feed using the Line Feed function.

1 Touch **ABC**.



2 Select the group of character patterns that you want to combine.

- The selected character is assigned as Number [1].
- You can select the patterns by touching them on the screen, or touching **<** or **>** to check the patterns to be selected, and then touch **Set**.



→ Numbers [1] and [2] are assigned temporarily to the patterns.

3 Touch **12** or **21** to choose the order of the 2 patterns.

4 Touch **OK** to return to the previous screen.

Changing the thread density

The thread density for some character and frame patterns can be changed. With certain types of patterns, the thread density can be changed by recalculating the number of stitches in the pattern. (page 49)

A setting between 80% and 120% in 5% increments can be specified.

1 Touch **Density**.



→ The screen shown below appears.

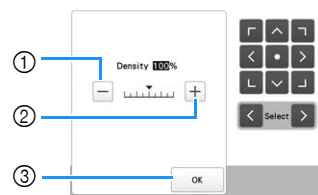

- 1 Make the pattern less dense.
- 2 Make the pattern more dense.
- 3 Close this screen.

■ Selects a less/more thread density



1 Touch the keys to select the desired thread density.

Each touch of a key slightly increases or decreases the thread density.

- To return to the original thread density (standard), select [100%].

2 After making the desired changes, touch **OK**.

Aligning the embroidery patterns

1 Select patterns that you want to align. (page 44)

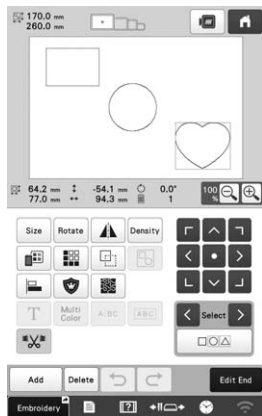

2 Touch , and then select the key for the desired alignment.

Example

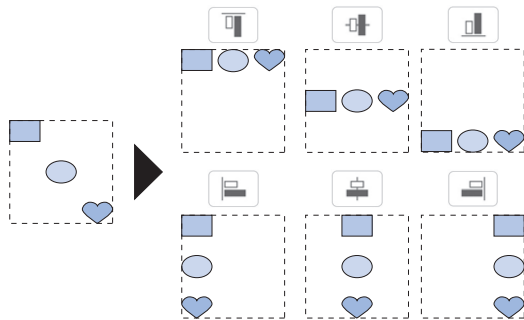

Memo

- You can select desired multiple patterns by directly touching each pattern on this screen.

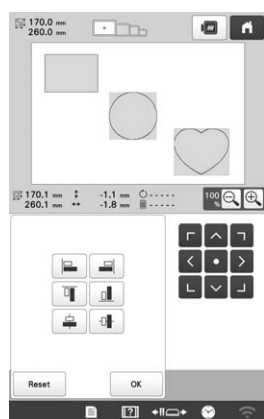

- Touch  to reset the alignment.

Designing repeated patterns

Using the border function, you can create an arrangement using repeated patterns.

1 Select the pattern that you want to repeat and touch .

2 Touch .

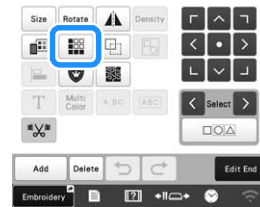



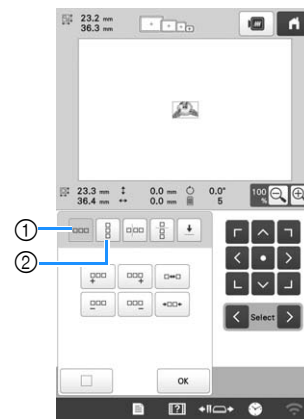

3 Select the direction in which the pattern will be repeated.



- ① Horizontal direction
- ② Vertical direction



→ The pattern direction indicator will change depending on the direction selected.

4 Use  to repeat the pattern on the left and  to repeat the pattern on the right.

- To delete the left pattern, touch .
- To delete the right pattern, touch .



5 Adjust the spacing of the repeated pattern.

- To widen spacing, touch .
- To tighten spacing, touch .



- ① Touch  to change a repeated pattern back to one single pattern.

Memo

- You can only adjust the spacing of patterns included in the red frame.

6 Complete repeated patterns by repeating steps 3 through 5.

7 After making the desired changes, touch .

Memo

- When there are two or more patterns, all patterns will be grouped together as one pattern in the red frame.

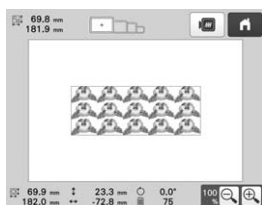



- When changing the direction in which the pattern will be repeated, all of the patterns in the red frame will automatically be grouped as one repeating unit.

Repeating one element of a repeated pattern

By using the Cut function, you can select one element of a repeated pattern and repeat only that single element. This function allows you to design complex repeated patterns.

1 Choose the direction in which the repeated pattern will be cut.

- Touch  to cut horizontally.
- Touch  to cut vertically.

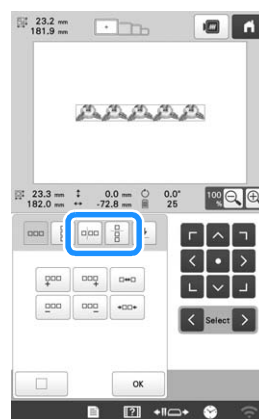

→ The pattern direction indicator will change depending on the direction selected.

2 Use and to select the cut line.

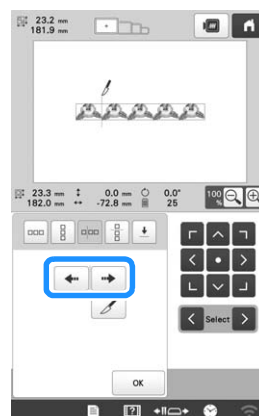

→ The cut line will move.

3 Touch .

→ The repeated pattern will be divided into separate elements.

4 Touch .

5 Use **<** and **>** to select the element to repeat.

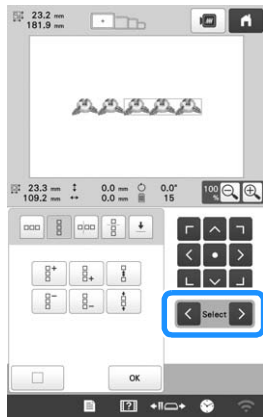

6 Repeat the selected element.

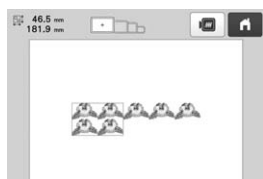

7 After making the desired changes, touch **OK**.

Memo

- Once you have cut a repeated pattern into separate elements, you cannot return to the original repeated pattern.
- Each element can be edited separately in the edit screen. Refer to “Selecting the pattern to be edited” on page 44.

Assigning thread marks

By embroidering thread marks, you can easily align patterns when embroidering a series. When embroidery is finished on a pattern, a thread mark in the shape of an arrow will be embroidered using the final thread. When embroidering a series of patterns, use the point of this arrow for positioning the following designs to be embroidered.

Memo

- When repeatedly embroidering individual patterns, thread marks can be embroidered around the perimeter of the pattern only.

1 Touch .

2 Touch .

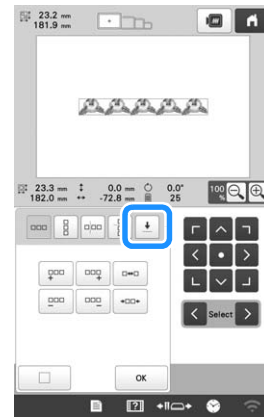

3 Touch  to select the thread mark to be embroidered.

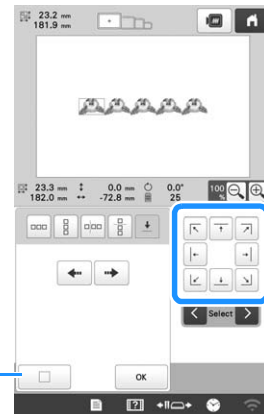

① Touch to cancel thread mark setting.

Memo

- When there are two or more elements, use **<** and **>** or **←** and **→** to select a pattern that you want to assign a thread mark(s) to.

4 Touch **OK**.

Memo

- If the combined border pattern is rotated in the embroidering settings screen, the thread mark will be removed.

■ Embroidering the pattern repeatedly

After creating the repeated pattern, rehoop the fabric in the embroidery frame and keep embroidering for the next pattern.

📖 Memo

- Using the optional magnetic sash frame, the fabric can be easily rehooped without removing the frame from the machine. For details, refer to the manual included with magnetic sash frame.

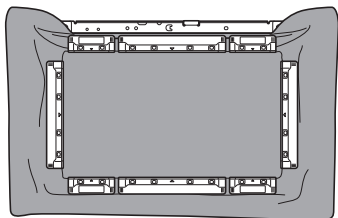

- 1 Create the repeated pattern with the thread mark at the center of the end of the pattern. (page 53)

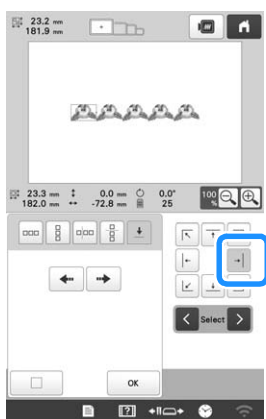

- 2 Touch **OK**, **Edit End**, then **Embroidery**.

- 3 Touch **Lock**, and then press the "Start/Stop" button to start embroidering.

→ When embroidering is finished, the thread mark is embroidered with the last thread color.

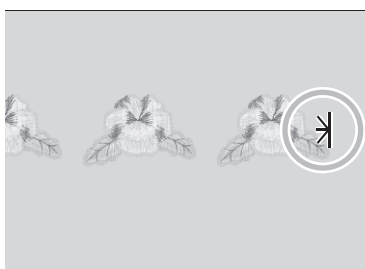

- 4 Remove the embroidery frame.

- 5 Rehoop the fabric in the embroidery frame.

💡 Note

- Adjust the position of the fabric so that the embroidering area for the next pattern is within the embroidering area of the embroidery sheet.

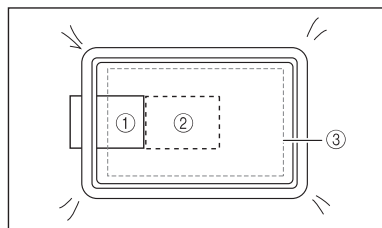

- ① Pattern embroidered first
- ② Position of pattern to be embroidered next
- ③ Embroidering area of embroidery sheet

- 6 Attach the embroidery frame to the machine, and then touch **Embroidery** in the embroidering settings screen.

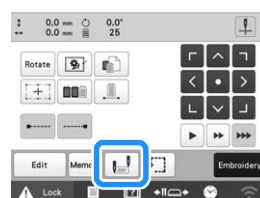

- 7 Touch **Start/Stop**.

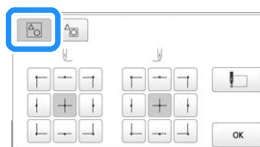

- 8 Touch **Start/Stop** to set the starting point to the left side of the pattern.

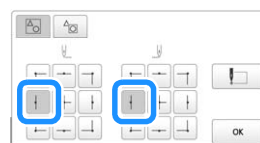



- 9 Touch **OK**.

- 10 Align the needle drop point with the thread mark on the fabric.

- 11 If the pattern position cannot be aligned using the positioning keys, rehoop the fabric, and then try again to align the position with the positioning keys.

💡 Note



- After you have aligned the position of the combined border pattern, do not rotate the pattern in the embroidering settings screen. If the pattern is rotated in the embroidering settings screen after alignment, the pattern will not be properly aligned with the thread mark or starting point.

- 12 Remove the thread mark.
- 13 Touch .
- 14 Touch , and then press the "Start/Stop" button to start embroidering.

EDITING COLORS

Specifying multi-color text

The alphabet pattern characters selected on page 41 are set to black. The color of the characters can be changed using the change thread color key; however, to change the color of individual characters, touch the Multi Color key to turn it on, and then specify the color for each character.

- 1 Touch  so that it changes to .



- Each touch of the key turns the setting either on or off.

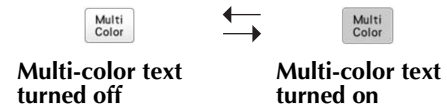

- For details on changing the thread color, refer to "Changing the colors of the pattern" below.

Changing the colors of the pattern

The colors of the pattern can be changed and previewed on the screen.

- 1 Touch .



→ The change thread color screen appears.

- 2 From the thread color sequence display, select the thread color whose color is to be changed.
 - If the desired thread color is not displayed, use the scroll bar on the right side to display it.

→ The selected thread color image appears.

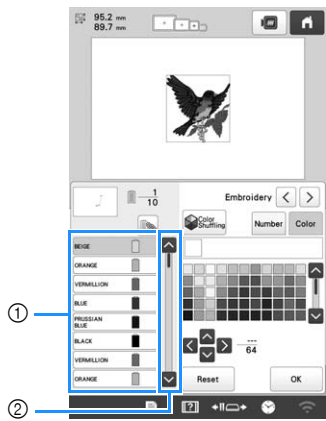

- ① Selected thread color image
 - ② Scroll bar
- To combine the same thread color when it is used more than once, select the thread color, and then touch . The key changes to , and all thread colors in the thread color sequence display that are the same as the one that was selected are highlighted in blue.

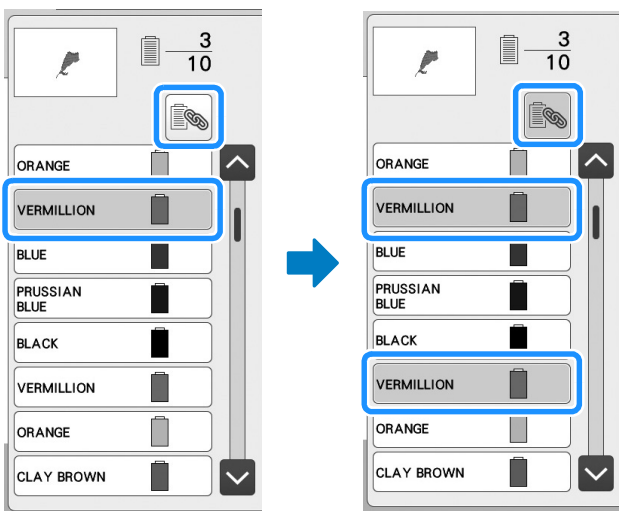

- The part of the pattern whose thread color is to be changed can be directly selected in the pattern.

- ③ Select the thread brand, and then touch , , or , or directly touch the desired color, to select the new color from the color palette.

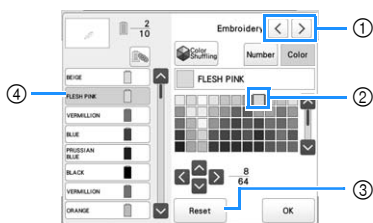

- ① Select the thread brand.
- ② The color in the box is the color that is selected.
- ③ Return to the original color.
- ④ Displays the name of the selected thread color.

→ In the pattern display area, the color of the selected part of the pattern is changed.

Memo

- Touch to specify a thread color by entering its number.

- ④ After changing the colors, touch .

Finding new color schemes with the Color Shuffling function

With the Color Shuffling function, the machine suggests new color schemes for the embroidery pattern that you have selected. After you select the desired effect from one of the four available color schemes ([Random], [Vivid], [Gradient] and [Soft]), the sample for the selected effect is displayed.

- ① Touch .

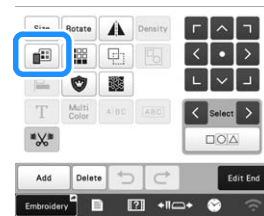

→ The change thread color screen appears.

- ② Touch .



Note

- This function may not be available depending on the pattern you select (ex. a bordered pattern, licensed pattern). If is grayed out, select another pattern.

3 Select the thread brand for colors and the number of colors you want to create the pattern with.



- ① Thread brand for colors
- ② Number of colors to be used

Memo

- If you touch so that it changes to , thread colors currently on the spool stand will be selected.

4 Select the desired effect.



- ① Effects for schemes
 - If you select [Random] or [Gradient], the color specifying screen will appear.
 - * If the thread spool priority key appears as , there is no color specifying screen. Proceed to step 7.
 - If you select [Vivid] or [Soft], there is no color specifying screen. Proceed to step 7.

5 Touch to set and specify the thread color to use in the effect.

- * If you don't need to specify the thread color, just set to .

[Manual] setting for [Random]

You can select up to 6 colors to be used in the [Random] effect. The effect will be created using the selected colors.

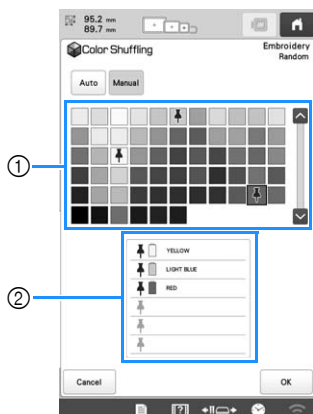

- ① Select colors from the palette.
- ② Selected colors are listed.

[Manual] setting for [Gradient]

You can select one color to be used in the [Gradient] effect. The effect will be created with the color you select.

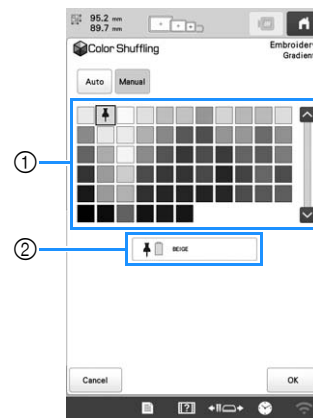

- ① Select a color from the palette.
- ② Selected color is displayed.

6 Touch .

7 Select the color scheme from samples.

- * Touch to add the new schemes. Maximum 20 pages of schemes can be reviewed.



- ① Touch to review the previous schemes.

Memo

- To temporarily register your favorite schemes, touch (to release your favorite schemes, touch again). 9 color schemes can be saved on the page. Touch to check the registered favorite schemes. To cancel the registration, touch .



8 Check the displayed color scheme, and then touch

- * : Return to the previous screen.
- * or : Display the other color schemes.



→ The change thread color screen will appear.

9 Touch to display the pattern editing screen.

SWITCHING THE THREAD COLORS ON THE SCREEN

If a thread color on the spool stand is different than the needle position thread color on the screen, the thread colors on the screen can be switched to match the spool stand thread color position.

Memo

- This function is not available when you set [Manual Color Sequence] to [ON] in settings screen.

1 Touch in the embroidering screen.

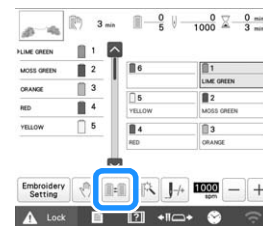

→ The spool selection screen appears.

2 Touch the number of the first needle bar that will be switched.

- To cancel the selection, touch the same needle number again.

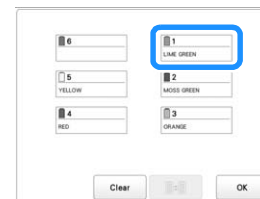

3 Touch the number of the other needle bar that will be switched. The two needle numbers are connected with an arrow.

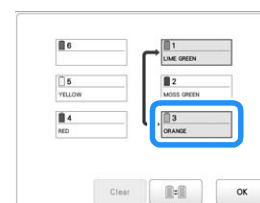

4 Touch to switch the two thread colors.

5 After making the desired changes, touch .

■ To cancel the thread color settings for all previously stitched design

Memo

- The color settings will be completely canceled even if the machine is in the middle of the embroidery.

1 Touch .

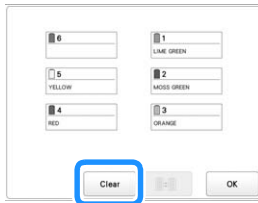

→ The thread color setting is canceled.

2 Touch .

→ Thread colors are assigned by the machine again, regardless of the previous spool setting.

Memo

- This function will not clear anchor settings of any of the needles which have been assigned a thread color. (page 107)

SELECTING/MANAGING THREAD COLORS FOR EACH NEEDLE BAR [Manual Color Sequence]

The thread colors assigned to each needle bar can be manually specified/managed. In addition, the thread colors can be assigned to needle bars automatically and more efficiently than when the settings are normally specified.

Memo

- This function cannot be used when the machine is in Link mode.

Convenience of the manual color sequence

The manual color sequence is convenient when the machine is being used under the following conditions.

■ When using embroidery data that has no thread color information, such as with DST files

The thread spools to be used can easily be selected for data with no thread color information. (For details, refer to "SPECIFICATIONS" on page 156.)

■ When the same combination of thread colors is always used

If specific thread colors are assigned to certain needle bars, the thread color settings can be changed with the needle bar number assignments, even when the pattern is changed. The operation is simplified if the same thread colors are always used.

■ When continuously embroidering with the same needle bar settings



If the settings are specified normally, the needle bar settings are canceled when the embroidering settings screen appears after embroidering stops. However, with [Manual Color Sequence], the needle bar settings continue to be applied unless the pattern is deleted or the machine is turned off.

This is useful if the same pattern is to be embroidered continuously multiple times.

Specifying the manual color sequence

Memo

- The [Manual Color Sequence] cannot be changed while operations are being performed in the embroidering screen.

- 1 Touch , then .
→ The general settings screen appears.
- 2 Locate [Manual Color Sequence] in the Settings pages.
- 3 Touch [ON] to select the manual color sequence.
 - When the machine is purchased, [OFF] is selected.
- 4 Touch  to return to the previous screen.
→ The icon for [Manual Color Sequence] appears in the screen.

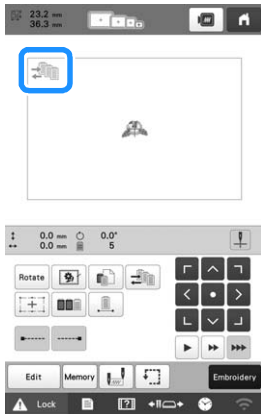

Using the manual color sequence

■ Manually assign thread colors to all needle bars

By specifying the thread colors used with this machine, embroidery can continue more efficiently simply by changing the needle bar assignments after a pattern is selected. With the normal method of specifying settings, only a maximum of 5 needle bars can be manually assigned thread colors; however, with the manual color sequence, all 6 needle bars can be assigned thread colors. (For details on specifying the settings, refer to page 107.)

■ Needle bar number settings

The needle bar used with each thread color can be specified.

Memo

- Using the procedure described in “Reserved needle bar and embroidery speed settings” on page 107, the finished embroidery colors can be checked in the screen if thread colors are assigned to thread spools.

- 1 In the embroidering settings screen, touch .
→ A screen appears, allowing the needle bar numbers to be selected.
- 2 From the thread color sequence display, select the thread color whose needle bar is to be changed.
 - If the desired thread color is not displayed, use the scroll bar on the right side to display it.

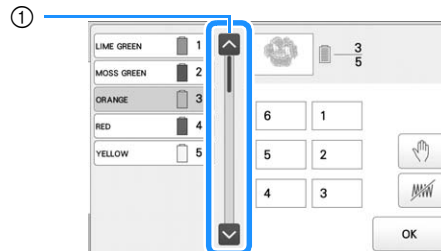

- 1 Scroll bar

- 3 Touch a number button (between 1 and 6) to select the number of the needle bar whose settings are to be specified.

→ The needle bar number for the thread color selected in step 2 changes to the selected needle bar number.

If the needle bar number was specified with reserved needle bar settings, the color of the thread spool on the left side changes to the specified thread color, and the pattern in the pattern display area also changes to the color of the specified needle bar.

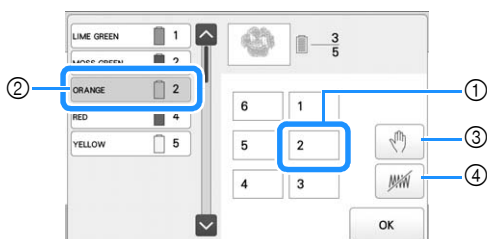

- ① Needle bar number specified with reserved needle bar settings
 - ② Needle bar set to a different number (needle bar 2)
 - ③ If a color is selected by touching this key, the machine stops before embroidering the selected color.
 - ④ If a color is selected by touching this key, the machine does not embroider the selected color when embroidering.
- ④ takes precedence if ③ and ④ are set at the same time.

■ Initializing thread color settings

With the manual color sequence, the thread color information on the machine can be initialized each time a new pattern is selected, and then the needle bars can be assigned. This allows the needle bar settings to be specified without being affected by the thread color information from the previous pattern.

Precautions on the manual color sequence

■ When embroidering a pattern containing seven or more colors

With the manual color sequence, the machine does not monitor the timing for replacing thread spools. Since the machine does not automatically stop and no message indicating that the thread spool be changed appears, as with the normal needle bar settings, follow the procedure below to set the machine to stop with thread spools that must be changed.

- Step 3 of "Using the manual color sequence" on page 60
- "Stopping the machine at the next color change" on page 105
- "Specifying pause locations before embroidering" on page 105

PREVIEWING THE IMAGE

Checking a preview image

Display the preview image to check that the embroidery will be performed as desired.

- 1 Touch .



→ The preview image is displayed.

Memo

- A preview image in a landscape orientation cannot be rotated to a portrait orientation, even if there is space at the top and bottom.

- 2 Touch  or  to display the desired type of frame, and then select the embroidery frame.

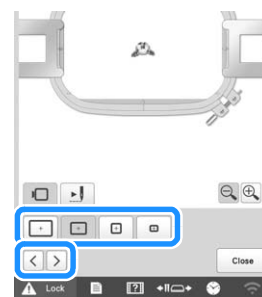

- After determining the type of embroidery frame holder and size of embroidery frame that are best for your embroidery, change the embroidery frame holder and embroidery frame that are installed. The machine will automatically detect the embroidery frame holder and embroidery frame and change the display.

- 3 Touch  to check the embroidering order.

→ The stitch simulator screen appears.

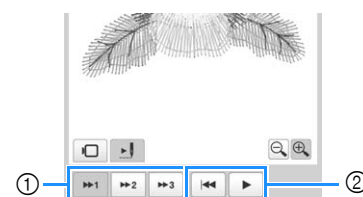

- ① Select the simulation speed.
- ② Operation keys

- Touch  to return to the embroidery frame holder/embroidery frame selection screen.

- 4 Touch  to return to the previous screen.

PREPARING THE FABRIC

⚠ CAUTION

- Your machine can embroider fabric that is up to 2 mm (5/64 inch) thick. If thicker fabric is embroidered, the needle may bend or break.

Attaching stabilizer (backing) to fabric

In order to prevent shrinkage of the stitching or misaligned patterns, we recommend that stabilizer (backing) be used for embroidering.

⚠ CAUTION

- When embroidering on thin or stretch fabrics, fabrics with a coarse weave or fabrics that easily allow the stitching to shrink, be sure to use stabilizer (backing) for embroidering. If stabilizer (backing) is not used while embroidering, the needle may bend or break or the pattern may become misaligned.

1 Using a steam iron, affix the iron-on stabilizer (backing) to the back of the fabric.

- Use a piece of stabilizer which is larger than the embroidery frame being used.

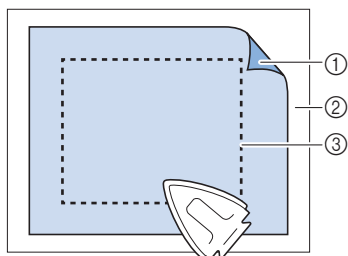

- ① Adhesive side of iron-on stabilizer (backing)
- ② Fabric (wrong side)
- ③ Size of the embroidery frame

📝 Memo

- When embroidering light or open designs on thin fabrics, such as organza or lawn, use a water-soluble stabilizer (backing). Water-soluble stabilizers dissolve when washed, allowing you to create beautiful embroidery that is not stiff.
- When embroidering fabric that should not be ironed or when embroidering an area that is difficult to iron, hoop a layer of the stabilizer (backing) under the fabric in the embroidery frame without ironing it.

Fabric/stabilizer compatibility chart

Fabric/ Garment	No. of Backing Pieces	No. of Topping Pieces
	Comments	
Terry cloth	1 tear-away	1 water-soluble
	Increase density and/or satin stitch width. Fine details and small lettering tend to get caught in the terry loops.	
Satin jacket	Heavy lining: None Light or no lining: 1 tear-away	None
	If garment slips in frame, causing alignment problems, wrap inner frame with masking tape or fabric bias tape. This provides a rough surface to grip garment and also helps minimize frame burn.	
Cotton sheeting	1 tear-away	None
	High-density or highly detailed designs may require more backing. If so, use two pieces of lightweight backing instead of one piece of heavy backing.	
Denim	1 tear-away	None
	Reduce speed if needle begins to heat up and the thread breaks.	
Headwear	Optional	Optional
	Change needles more often than usual because the buckram backing dulls needles faster. A lightweight tear-away backing helps reduce thread breaks and regulates thread tension. Use a topping on corduroy or foam cap fronts.	
Dress shirt (woven)	1 tear-away	None
	High-density or highly detailed designs may require more backing. If so, use two pieces of lightweight backing instead of one piece of heavy backing.	
Golf shirt	1 cut-away or iron-on cut-away	Optional
	Use topping for designs containing small lettering or a lot of detail, and also for piqué knits.	
Canton fleece	1 tear-away	Optional
	Use a topping if the garment has a textured surface, such as a basketweave or pronounced twill.	
Canvas	1 tear-away	None
	Frame tightly.	

Fabric/ Garment	No. of Backing Pieces	No. of Topping Pieces
	Comments	
Corduroy	1 tear-away	1 water-soluble
	A higher stitch density or more under stitches, as well as a topping, may be necessary to prevent stitches from sinking into the fabric.	
Lingerie or silk	1 or 2 lightweight tear-away	Optional
	Reduce embroidery speed. The thread tension should be low. Use topping for designs with high detail or small lettering. For very fine fabrics, use a thinner thread. Avoid extremely narrow satin stitching on letters or details; instead increase satin stitch width or use a bean stitch. Gently remove (don't pull) backing and topping from garment.	
Sweater knit	1 cut-away or iron-on cut-away	1 water-soluble
	Use tightly woven organza or curtain fabric in a matching color as a backing for bulky or "holey" knits.	
Sweatshirt	1 cut-away or adhesive tear-away	Optional
	Highly detailed designs may require two layers of lightweight cut-away stabilizer. Use a topping on extra-thick fabrics or with fine-detail designs.	
T-shirt	1 light-weight cut-away or iron-on cut-away	Optional
	Use a topping on designs with fine detail or small lettering. Tensions should be light. Avoid stitch-heavy designs.	

Note

- Due to the wide variety of fabrics and stabilizers available, the above information should be used as guideline only. If unsure of a particular fabric/stabilizer combination, please embroider a test sample prior to the finished garment.

Hooing the fabric in the embroidery frame

Note

- If the fabric is not taut, the pattern may be misaligned or the fabric may pucker. Follow the procedure described below to firmly smooth the fabric in the embroidery frame so that the fabric is not loose. In addition, be sure to work on a level surface when putting the fabric in the embroidery frame.

1 Select an embroidery frame.

From the sizes of embroidery frames indicated in the screen, select the embroidery frame that you wish to use.



Embroidery frames that can be used appear lighter (☐+) embroidery frames that cannot be used appear darker (☐).

Memo

- If the embroidery frame holder is not attached to the machine, the embroidering area will not display the correct frame size. (page 66)

Embroidery frame types

There are four sizes of embroidery frames included with this machine, which are used with the included embroidery frame holder A. For details on the uses for each frame, refer to "Correctly using the embroidery frames" on page 67.

Icon	Name
Embroidery area	
	Extra-large embroidery frame
300 mm (W) × 200 mm (H) (11-3/4 inches (W) × 7-7/8 inches (H))	
	Large embroidery frame
180 mm (W) × 130 mm (H) (7-1/8 inches (W) × 5-1/8 inches (H))	
	Medium embroidery frame
100 mm (W) × 100 mm (H) (4 inches (W) × 4 inches (H))	
	Small embroidery frame
60 mm (W) × 40 mm (H) (2-3/8 inches (W) × 1-1/2 inches (H))	

If you use any of the optional embroidery frames, the following icons appear in the screen.

- : Embroidery frame holder B
- : Embroidery frame holder C
- : Embroidery frame holder D
- : Embroidery frame holder E
- : Embroidery frame holder F
- : Cap frame
- : Cylinder frame
- : Magnetic sash frame

⚠ CAUTION

- Use the four included frames or recommended optional frames.
- If the size of the embroidery frame is wrong, the embroidery frame may hit the presser foot and damage the machine or cause injury to the user. (For details on embroidery frames, refer to page 68.)

💡 Note

- The embroidery frame indicators show all embroidery frame sizes in which the embroidery pattern can be embroidered. Be sure to use an embroidery frame of the most suitable size. If an embroidery frame that is too large is used, the pattern may be misaligned or the fabric may pucker. (page 67)

■ Hooping the fabric in the embroidery frame

1 Loosen the screw on the outer frame.

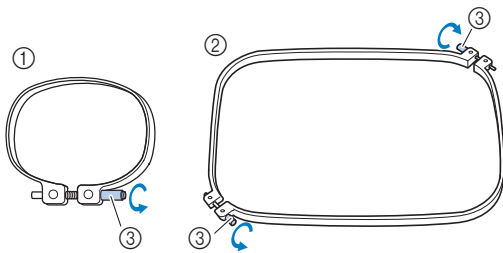

- ① Small or medium embroidery frame
- ② Extra-large or large embroidery frame
- ③ Screw

2 Place the stabilizer and fabric with right side up on top of the outer frame.

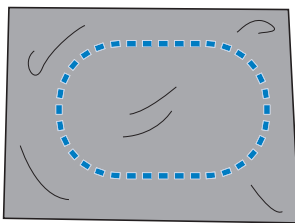

- The outer frame does not have a front or back side. Either side can be used as the front.

3 Press the inner frame into the outer frame.

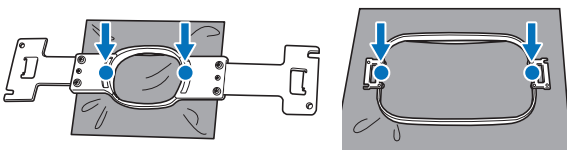

- Be sure that there are no wrinkles in the fabric after it is hooped in the embroidery frame.

4 Lightly tighten the screw.

- Align the inner and outer frames so that their tops are even.

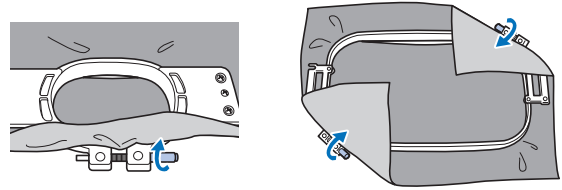

5 Securely tighten the screw, and then check to make sure that the fabric is taut.

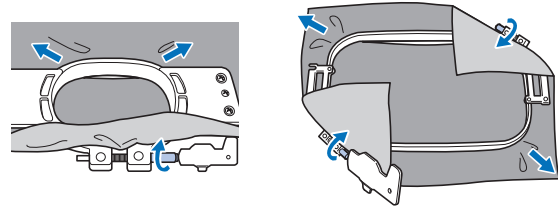

- Use the 3-way screwdriver to tighten the screw securely.
- After securing the fabric, lightly tapping it should produce a drum-like sound.
- Firmly clamp together the inner and outer frames so that their tops are even.

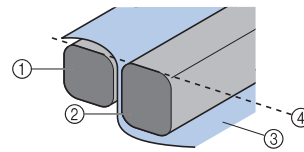

- ① Outer frame
- ② Inner frame
- ③ Right side of fabric
- ④ Top of inner and outer frames are even

📖 Memo

- To correctly frame the fabric in the embroidery frame, we recommend using a flat surface.

■ Using the embroidery sheet

In order to hoop the fabric so that the pattern will be embroidered in the correct position, use the guidelines on the embroidery sheet to accurately align the fabric in the frame.

1 With a fabric marker, mark the area of the fabric you want to embroider.

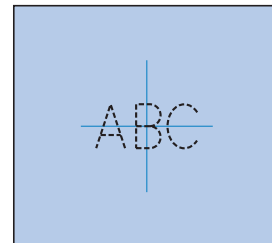

- 2** Place the embroidery sheet on the inner frame. Align the guidelines on the embroidery sheet with the marks that you drew on the fabric.

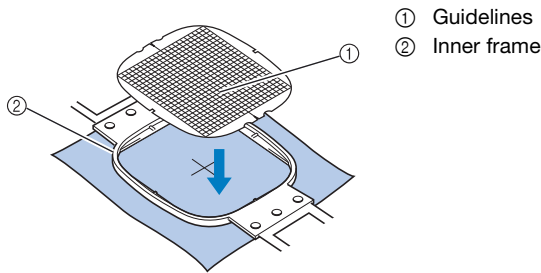

- 3** Gently stretch the fabric, so that there are no folds or wrinkles.

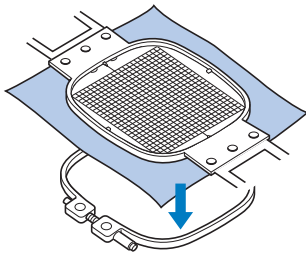

- 4** Remove the embroidery sheet.

Embroidering large pieces of fabric or heavy clothing

When embroidering large pieces of fabric or heavy pieces of clothing, use a clothespin or binder clip to fasten the excess fabric to the embroidery frame so that it does not hang down from the frame. Embroidering with excess fabric hanging down from the embroidery frame may prevent the frame from moving properly and may result in a misaligned pattern.

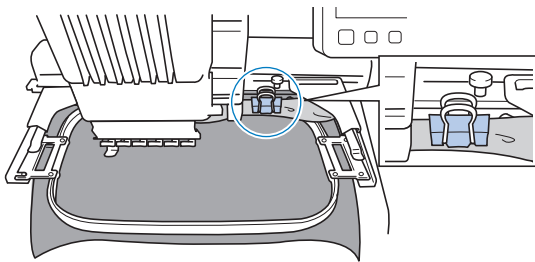

- Use a clothespin or binder clip to fasten the excess fabric to the embroidery frame.

Note

- We recommend installing the optional wide table to support large and heavy clothing.

Embroidering small pieces of fabric

When embroidering small pieces of fabric that cannot be hooped in an embroidery frame, use stabilizer material as a base. After lightly ironing the fabric to the stabilizer material, hoop it in the embroidery frame. If stabilizer material cannot be ironed onto the fabric, attach it with a basting stitch. After completing the embroidery, remove the stabilizer material carefully.

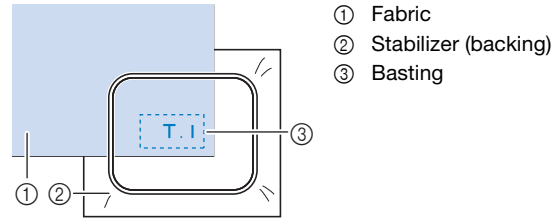

Embroidering items, such as bags and tubular items, that have limitations to being hooped in the embroidery frame

Rotate the pattern before embroidery. For details on rotating the pattern, refer to “Understanding the pattern editing screen” on page 46.

Example: When embroidering a pillowcase Rotate the pattern 90 degrees to the left before embroidering.

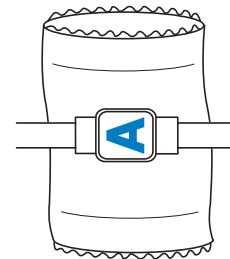

Example: When embroidering a T-shirt Rotate the pattern 180 degrees. Pass the machine bed through from the waist of the T-shirt, not from the neck, and attach the embroidery frame to the machine. This will prevent the neck of the shirt from being stretched when the embroidery frame is moving.

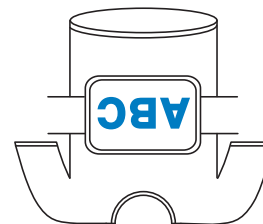

Memo

- The optional versatile magnetic frame is useful for embroidering tubular items.

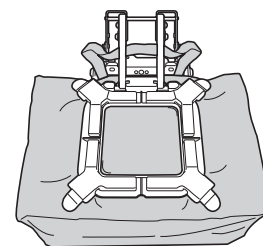

ATTACHING THE EMBROIDERY FRAME TO THE MACHINE

After hooping the fabric in the embroidery frame, attach the frame to the machine. Embroidery frame holders A and B are included accessories with this machine. Install embroidery frame holder A when an included embroidery frame is to be used. (For details on the embroidery frame holders, refer to page 67.)

⚠ CAUTION

- If the embroidery frame is not correctly attached, it may hit the presser foot and damage the machine or cause injury to the user.
- When attaching the embroidery frame, make sure that the "Start/Stop" button is lit in red. If the "Start/Stop" button is flashing in green, the machine may start embroidering. If the machine accidentally starts operating, injuries may result.
- When attaching the embroidery frame, make sure that the embroidery frame does not hit any other part of the machine.

Attaching the embroidery frame

Adjust the width of the embroidery frame holder to the size of the embroidery frame, and then attach the embroidery frame to the machine. As an example, the procedure for attaching the small embroidery frame is described below.

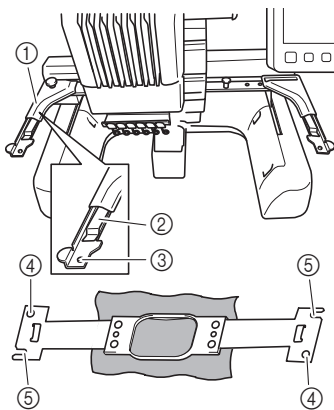

- ① Left arm of embroidery frame holder
Move the arm of the embroidery frame holder to the left or right to adjust it to the size of the embroidery frame.
- ② Clip on embroidery frame holder
Insert the embroidery frame into the clips on the embroidery frame holder.
- ③ Positioning pin
- ④ Holes
- ⑤ Positioning slots

1 Loosen the two left thumb screws on the embroidery frame holder.

If the screw is too tight, please use the included 3-way screwdriver. (page 21)

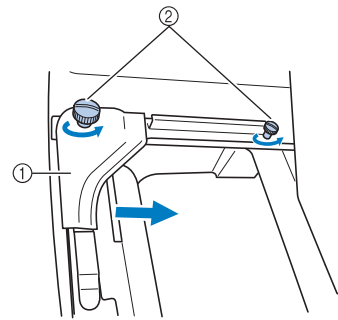

- ① Left arm
- ② Thumb screws

- The left arm of the embroidery frame holder can be moved.
- Only loosen the thumb screws a maximum of 2 turns counterclockwise. Do not remove the screw.

2 Move the left arm to align the screw on the right side with the mark for the embroidery frame to be installed, and then tighten the thumb screws.

For this example, align with mark ④.

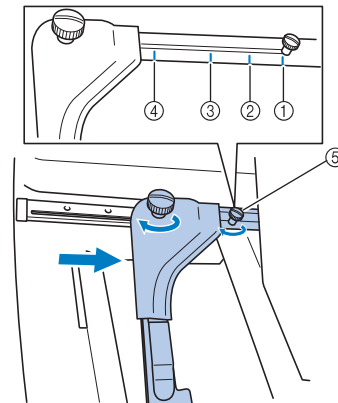

- ① Mark for extra-large embroidery frame
300 mm (W) × 200 mm (H)
(11-3/4 inches (W) × 7-7/8 inches (H))
- ② Mark for large embroidery frame
180 mm (W) × 130 mm (H)
(7-1/8 inches (W) × 5-1/8 inches (H))
- ③ Mark for medium embroidery frame
100 mm (W) × 100 mm (H)
(4 inches (W) × 4 inches (H))
- ④ Mark for small embroidery frame
60 mm (W) × 40 mm (H)
(2-3/8 inches (W) × 1-1/2 inches (H))
- ⑤ Align the screw with the mark.

Note

- Please firmly tighten the two thumb screws with included 3-way screwdriver. If the thumb screws are not tightened, any of the following problems may occur.
 - The machine will detect the embroidery frame size incorrectly.
 - The starting position for the embroidery frame is misaligned.
 - The embroidery pattern is misaligned.

→ The embroidery frame holder is ready for the embroidery frame to be attached.

- 3** Hold the embroidery frame level, and then simultaneously align both the left and right mounts with the embroidery frame holder clips.

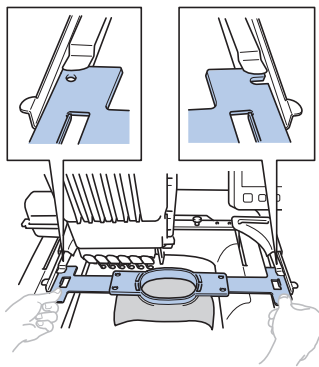

- The inner frame should be on top.

- 4** Insert the embroidery frame until it snaps into place.

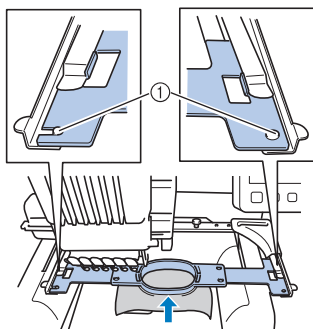

- ① Make sure that the pins on the left and right arms of the embroidery frame holder fit into the positioning slot and hole on the embroidery frame.

Correctly using the embroidery frames

The various types of embroidery frames and their uses are described below.

In addition to the included embroidery frames, there are many frames that can be used with this machine. (Refer to “Optional accessories” on page 14.)

CAUTION

- Only use embroidery frames of the sizes indicated in the screen, otherwise the embroidery frame may hit the presser foot, which may result in injuries.

Embroidery frame holders

Two types of embroidery frame holders (embroidery frame holder A and embroidery frame holder B) are included with this machine.

Embroidery frame holder A is used with the four included embroidery frames and the optional 300 mm (W) × 200 mm (H) (11-3/4 inches (W) × 7-7/8 inches (H)) Flat frame. Embroidery frame holder B is used with the optional embroidery frames. In addition, if you purchase optional round frame set, clamp frame set, compact frame set or versatile magnetic frame kit, specified frame holder C, D,

E or F is included. For details on which embroidery frame can be installed on each embroidery frame holder, refer to “Types of embroidery frames/frame holders and their applications” on page 68.

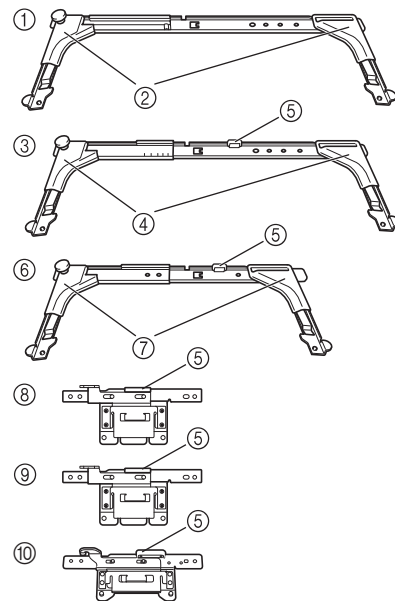

- ① Embroidery frame holder A
- ② White corner covers
- ③ Embroidery frame holder B
- ④ Light gray corner covers
- ⑤ Magnet
- ⑥ Embroidery frame holder C (optional)
- ⑦ Dark gray corner covers
- ⑧ Embroidery frame holder D (optional)
- ⑨ Embroidery frame holder E (optional)
- ⑩ Embroidery frame holder F (optional)

When difficult to replace the embroidery frame

Depending on the position of the needle bars, it may be difficult to replace the embroidery frame. In that case, follow the procedure described below to move the embroidery frame.

- 1** Touch .

→ The needle bar move screen appears.

- 2** Touch .

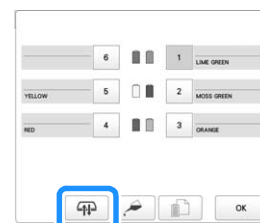









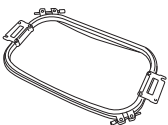

→ The carriage automatically moves to a position where the embroidery frame can easily be replaced.

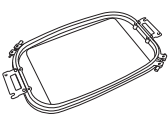
- Touch  to close the needle bar move screen and to move the carriage to the previous position.

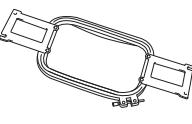

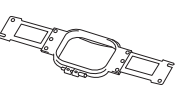

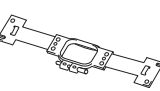

■ Types of embroidery frames/frame holders and their applications

When the reference page is “*”, contact your authorized Brother dealer.

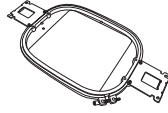

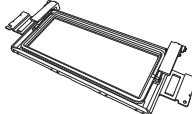

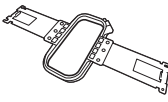
Embroidery frames that use embroidery frame holder A

Embroidery frame	Embroidering area	
	Usage	
	Reference page	
Extra-large embroidery frame 	300 mm (W) × 200 mm (H) (11-3/4 inches (W) × 7-7/8 inches (H))	
	Use when embroidering connecting characters or patterns, combined patterns or large patterns. page 64	
Flat frame (optional) 	300 mm (W) × 200 mm (H) (11-3/4 inches (W) × 7-7/8 inches (H))	
	Use when embroidering jackets and other thick garments. *	
Large embroidery frame 	180 mm (W) × 130 mm (H) (7-1/8 inches (W) × 5-1/8 inches (H))	
	Use when embroidering patterns with a size less than 180 mm (W) × 130 mm (H) (7-1/8 inches (W) × 5-1/8 inches (H)). page 64	
Medium embroidery frame 	100 mm (W) × 100 mm (H) (4 inches (W) × 4 inches (H))	
	Use when embroidering standard-sized patterns. page 64	
Small embroidery frame 	60 mm (W) × 40 mm (H) (2-3/8 inches (W) × 1-1/2 inches (H))	
	Use when embroidering small-sized patterns, such as name tags. page 64	





Embroidery frames that use embroidery frame holder B

Embroidery frame	Embroidering area	
	Usage	
	Reference page	
Quilt frame (optional) 	200 mm (W) × 200 mm (H) (7-7/8 inches (W) × 7-7/8 inches (H))	
	Use when embroidering pieces for quilts. *	
Border frame (optional) 	300 mm (W) × 100 mm (H) (11-3/4 inches (W) × 4 inches (H))	
	Use when embroidering a long string of characters or patterns. *	
Sleeve frame (optional) 	70 mm (W) × 200 mm (H) (2-3/4 inches (W) × 7-7/8 inches (H))	
	Use when embroidering long items such as shirt sleeves. *	



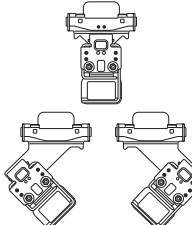

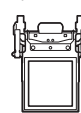

Embroidery frames that use embroidery frame holder C (optional)

Embroidery frame	Embroidering area	
	Usage	
	Reference page	
Round frame (optional) ∅=diameter 	∅160 mm (6 inches) ∅130 mm (5 inches) ∅100 mm (4 inches)	  
	Use when adding a built-in embroidery pattern to a sleeve. Select the frame appropriate for the size of the pattern. *	

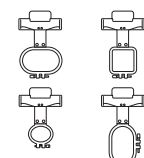

Embroidery frames that use embroidery frame holder D (optional)

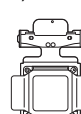
Embroidery frame	Embroidering area	
	Usage	
	Reference page	
Clamp frame S (optional) 	45 mm (W) × 24 mm (H) (1-3/4 inches (W) × 7/8 inches (H))	
Use when embroidering specialty shaped items that cannot be held in normal frames, such as shoes and gloves. *		
Clamp frame M (optional) 	100 mm (W) × 100 mm (H) (4 inches (W) × 4 inches (H))	
Use when embroidering specialty shaped items, such as narrow bags. *		





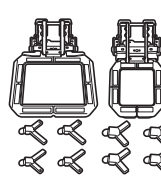

Embroidery frames that use embroidery frame holder E (optional)

Embroidery frame	Embroidering area	
	Usage	
	Reference page	
Compact frame (optional) 	70: 70 mm (W) × 41 mm (H) (2-3/4 inches (W) × 1-5/8 inches (H)) 50: 50 mm (W) × 50 mm (H) (2 inches (W) × 2 inches (H)) 44: 44 mm (W) × 38 mm (H) (1-3/4 inches (W) × 1-1/2 inches (H)) Vertical: 33 mm (W) × 75 mm (H) (1-5/16 inches (W) × 2-15/16 inches (H))	   
Use when embroidering logos or patterns on small items. *		
Magnetic frame (optional) 	50 mm (W) × 50 mm (H) (2 inches (W) × 2 inches (H))	
Use to prevent the embroidery frame from leaving traces in the fabric. *		

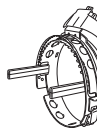
Embroidery frames that use embroidery frame holder F (optional)

Embroidery frame	Embroidering area	
	Usage	
	Reference page	
Versatile magnetic frame (optional) 	180 mm (W) × 130 mm (H) (7-1/8 inches (W) × 5-1/8 inches (H)) 100 mm (W) × 100 mm (H) (4 inches (W) × 4 inches (H))	 
A variety of fabrics can be easily and firmly secured in the frame. *		

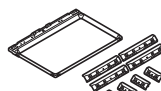
Embroidery frames that do not use embroidery frame holders

Embroidery frame	Embroidering area	
	Usage	
	Reference page	
Cap frame (PRCFH3) (included in some countries or regions) 	130 mm (W) × 60 mm (H) (5-1/8 inches (W) × 2-3/8 inches (H))	
Use when embroidering caps. Baseball (golf) caps, tulip hats and bucket hats can be embroidered with these frames. This frame cannot be used with hats having a front area of 50 mm (2 inches) or less, such as sun visors and children's hats. In addition, this frame cannot be used with hats that have a brim longer than 80 mm (3-1/8 inches). *		
Flat brim cap frame (PRCFH5) (optional) 	130 mm (W) × 60 mm (H) (5-1/8 inches (W) × 2-3/8 inches (H))	
Use when embroidering caps. In addition to caps compatible with cap frame (PRCFH3), this frame can be used to embroider flat brim caps and children's caps. Compared with cap frame (PRCFH3), this frame can be used to embroider closer to the cap brim. *		
Magnetic sash frame (optional) 	360 mm (W) × 200 mm (H) (14 inches (W) × 7-7/8 inches (H)) Embroidery area: 300 mm (W) × 200 mm (H) (11-3/4 inches (W) × 7-7/8 inches (H))	
Use when embroidering connecting characters or patterns, combined patterns or large patterns. *		

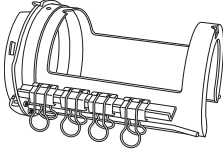
Embroidery frame	Embroidering area	
	Usage	
	Reference page	
Cylinder frame (optional)	90 mm (W) × 80 mm (H) (3-1/2 inches (W) × 3 inches (H))	
	Use when embroidering tubular and curved fabric, such as shirt sleeves and turtlenecks.	
	*	

Note

- The embroidery frame indicators show all embroidery frame sizes in which the embroidery pattern can be embroidered. Be sure to use an embroidery frame of the most suitable size. If the embroidery frame that is used is too large, the pattern may be misaligned or the fabric may pucker.
- When embroidering with an optional embroidery frame (border frame, quilt frame, flat frame or magnetic sash frame), the optional wide table must be installed onto the machine.
- Due to the weight of the embroidery frame and fabric, it is recommended that the optional wide table be used to prevent the frame holder from bending, which may result in the distortion of your design or machine damage.



SPECIFYING EMBROIDERING SETTING





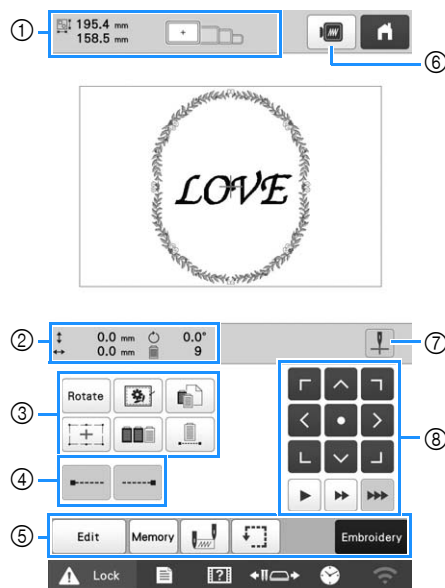



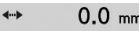



Understanding the embroidering settings screen











Memo

- Keys available in this screen differ when you set [Manual Color Sequence] to [ON] in settings screen. (page 60, page 72)





No.	Display Key Name	Function	Page
①	 Pattern size	Shows the size of the embroidery pattern currently displayed in the pattern display area. The top value shows the height and the bottom value shows the width. If the embroidery pattern consists of multiple patterns that have been combined, the size of the entire pattern, including all patterns, is shown.	—
	 Embroidery frame indicators	Shows the sizes of embroidery frames that can be used to embroider the pattern currently displayed in the pattern display area.	63
②	 Distance from center (vertical)	Shows the vertical distance that the pattern being combined/edited is moved.	—
	 Distance from center (horizontal)	Shows the horizontal distance that the pattern being combined/edited is moved.	—

No.	Display Key Name	Function	Page	
②	 0.0° Rotation angle	Shows the rotation angle that the pattern being edited is rotated.	—	
	 9 Number of thread colors changes	Shows the total number of thread colors for the pattern that is being edited.	—	
③	 Rotate Rotate key	Rotate the entire embroidery pattern.	—	
	 Embroidery basting key	When embroidering fabric that stabilizer cannot be attached to, embroider basting stitches around the pattern to prevent the stabilizer from moving. Stabilizer prevents shrinkage of the stitching and misaligned patterns.	93	
	 Individual thread color setting key	Change the settings for individual thread colors, such as temporarily stopping or skipping embroidering.	105	
	 Embroidery crosshair positioning laser key	Align the pattern position using the the embroidery crosshair positioning laser.	99	
	 Color sorting key	Touch to rearrange the stitching sequence for combined patterns.	73	
	 Uninterrupted embroidery key/ Monochrome	Touch to embroider the pattern in the same color, regardless of specified color changes. The entire thread color sequence display will appear in the same color.	106	
	④	 Lock stitching (beginning) key	Specify that automatic lock stitch is embroidered at the beginning of the pattern and at the beginning of embroidering after thread trimming.	72
		 Lock stitching (end) key	Specify that automatic lock stitch is embroidered when the thread is trimmed.	72
⑤	 Edit Edit key	Return to the pattern editing screen.	—	
	 Memory Memory key	Save a pattern in the machine's memory, USB media or a computer.	116	

No.	Display Key Name	Function	Page
⑤	 Starting/ ending position key	Specify the needle position at the beginning of embroidering and at the end.	112
	 Trial embroidery key	Move the embroidery frame so that the embroidering position can be checked.	74
	 Embroidery key	Finish all operations in the embroidering settings screen and continue to the embroidering screen.	—
⑥	 Preview key	Display an image of the pattern that is to be embroidered so it can be previewed.	61
	⑦	 Embroidery crosshair positioning laser on/off key	Switch on/off the embroidery crosshair positioning laser.
⑧		 Positioning keys	Move the embroidering position of the whole pattern in the direction of the arrow. (If  is touched, the embroidering position is moved to the center of the embroidering area.)
	 Frame movement speed keys	Select the speed to move the frame.  : Touch to move the frame by 0.1 mm (1/64 inch).  : Touch to move the frame by 0.5 mm (1/32 inch).  : Keep touching to move the frame at maximum speed.	—

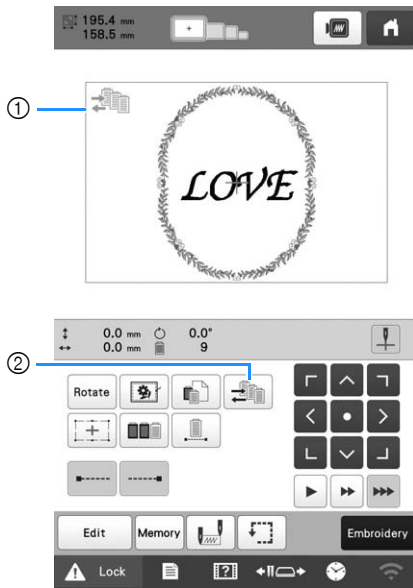
■ In the [Manual Color Sequence] mode



No.	Display	Function	Page
	Key Name		
①	 Manual color sequence mode icon	This icon appears when the machine is in the [Manual Color Sequence] mode.	60
②	 Manual color sequence key	Change the needle bar color setting. This key appears when you set [Manual Color Sequence] to [ON] in settings screen.	60

Automatic lock stitch setting

When the machine is purchased, it is set to automatically embroider lock stitches at the beginning of the pattern, before embroidering after each thread color change, and before trimming the thread.

Memo

- Automatic lock stitching cannot be applied to patterns whose jump stitches will not be trimmed (). (page 49)

■ To change the lock stitches being embroidered at the beginning of the pattern, at the beginning of embroidering each thread color change and at the beginning of embroidering after the thread trim.

- 1 Make sure that the lock stitching (beginning) key appears as .



- Each touch of the key turns the setting either on or off.



Automatic lock stitch setting turned on



Automatic lock stitch setting turned off

Memo

- If the first stitch length is less than 0.8 mm (1/32 inch), the lock stitch won't be inserted.

■ To change the lock stitches being embroidered before the thread is trimmed.

- 1 Make sure that the lock stitching (end) key appears as .

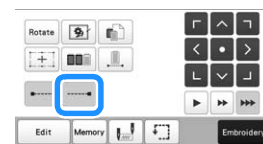

- Each touch of the key turns the setting either on or off.



Automatic lock stitch setting turned on



Automatic lock stitch setting turned off

Memo

- The automatic lock stitch setting stays the same until the key is touched again. The setting specified before the machine is turned off remains selected the next time that the machine is turned on.

Thread color sorting

You can embroider more efficiently by sorting combined designs' thread colors.

Before starting to embroider, touch  in the embroidering settings screen to rearrange the embroidering order and sort it by thread colors.

Embroidering screen



Embroidering settings screen

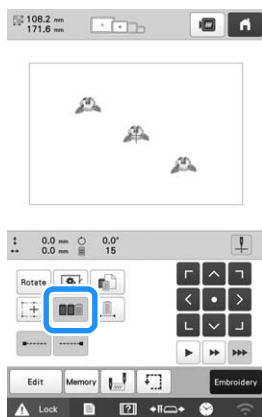

Embroidering screen

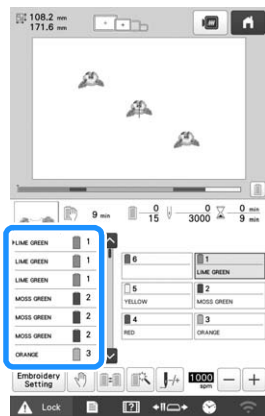

The embroidery color order is rearranged and sorted by thread colors.

Touch  to cancel the color sorting and embroider with the embroidery color order.

 **Note**

- This function does not work on overlapping designs.

CHECKING THE POSITION OF THE PATTERN

The pattern is usually placed at the center of the embroidery frame. If you want to change where in the fabric the pattern will be embroidered, you can check the position before starting embroidering.

Checking the needle drop point with the embroidery crosshair positioning laser

- 1 Make sure that the embroidery crosshair positioning laser on/off key appears as .

→ The embroidery crosshair positioning laser indicates the needle drop point.

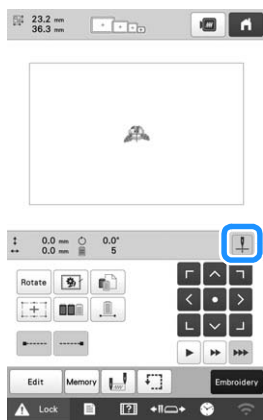

- Each touch of the key turns the setting either on or off.





Embroidery crosshair positioning laser lights up.

Embroidery crosshair positioning laser lights off.

Memo

- With certain types of embroidery frames, the embroidery crosshair positioning laser function cannot be used.
- If the surface of the fabric is too uneven or rough, check and adjust the alignment of the embroidery crosshair positioning laser and the needle drop point before starting to embroider.
- When using the cap frame, check and adjust the alignment of the embroidery crosshair positioning laser and the needle drop point before starting to embroider.
- You can align the embroidering position with the embroidery crosshair positioning laser function. (page 98)

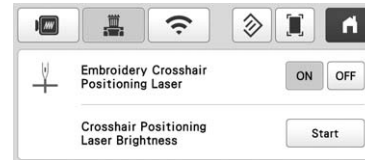

Adjusting the brightness of the embroidery crosshair positioning laser

- 1 Touch , then .
→ The general settings screen appears.
- 2 Locate [Crosshair Positioning Laser Brightness] in the Settings pages.



- 3 Touch .
→ The embroidery crosshair positioning laser lights up, and the brightness adjustment screen for the embroidery crosshair positioning laser appears.



- 4 Touch  or  to adjust the brightness of the embroidery crosshair positioning laser.

- 5 Touch  twice to return to the previous screen.

Checking the embroidery pattern

The carriage moves and shows the pattern position. Watch the embroidery frame closely to make sure the pattern will be embroidered in the right place. At this time, using the embroidery crosshair positioning laser function, the pattern position is projected on the fabric and you can check it more clearly.

- 1 Make sure that the embroidery crosshair positioning laser on/off key appears as .

→ The embroidery crosshair positioning laser indicates the needle drop point.



- 2 Touch .



→ The embroidery frame moves to show the embroidery area.

Memo

- The presser foot is slightly lowered when the embroidery crosshair positioning laser function is set to [OFF].

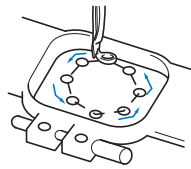



Carefully watch the movement of the embroidery frame and check that the embroidery will stitch in the desired location and that the embroidery frame does not hit the presser foot.

Temporarily stopping to check the area

The embroidery frame can be temporarily stopped at a desired position or the checking of the embroidering area can be stopped.

- 1 When the embroidery frame moves to the desired position, touch  again.

→ The embroidery frame stops moving, and the message asking if you want to continue the trial appears.

- 2 To continue moving the embroidery frame, touch  . To stop checking the embroidering area, touch  .

Finding the embroidering position

By locking the needle bar (securing the needle and presser foot in the down position), the needle drop point can easily be seen.

- 1 The embroidery crosshair positioning laser will be aligned with the needle that is over the opening in the needle plate. As shown in the illustration, insert the Allen screwdriver into the hole in this needle clamp to slowly lower the needle bar down until needle bar stops then clicks into the lock position.

Note

- Make sure that the needle is not lowered beyond the positioning click into the fabric.

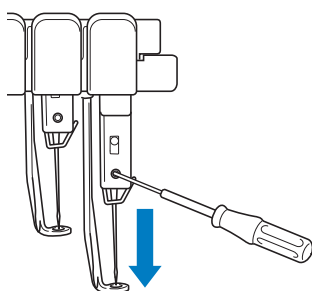

→ The needle and presser foot are locked in the down position.

- 2 Touch the arrow keys in the embroidering settings screen to move the embroidery frame so that the needle drop point is at the center of the area where you wish to embroider.

- With your finger or the touch pen, drag the pattern to move it.

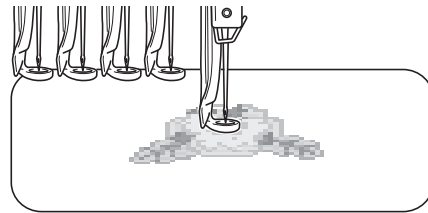

- When specifying the starting of stitching, align the needle drop point with the point specified as the starting of stitching. (For details on specifying the starting/ending of stitching, refer to page 112.)

Unlocking the needle bar

- 1 Display the embroidering screen, and then touch the key for any needle bar other than the one that is locked.

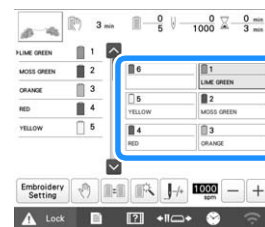

→ The needle bar is unlocked and will return to original position.

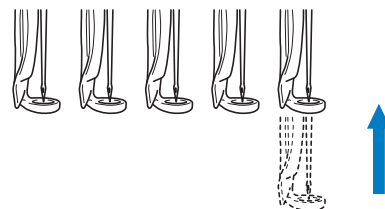

UPPER THREADING

Check the embroidering screen for information on which needle bars should be threaded with specified thread colors, and then thread the upper threads.

Checking the needle bars and thread colors

In the embroidering settings screen, touch **Embroidery** to display the embroidering screen. A screen indicating that the spools need to be changed will appear if the thread colors from the previous embroidery project will not be used. If you set [Manual Color Sequence] to [ON] in the settings screen, the message does not appear even if the thread spools need to be changed. (Refer to "SELECTING/MANAGING THREAD COLORS FOR EACH NEEDLE BAR [Manual Color Sequence]" on page 59.)

Embroidering screen (For details on the screen, refer to page 84.)

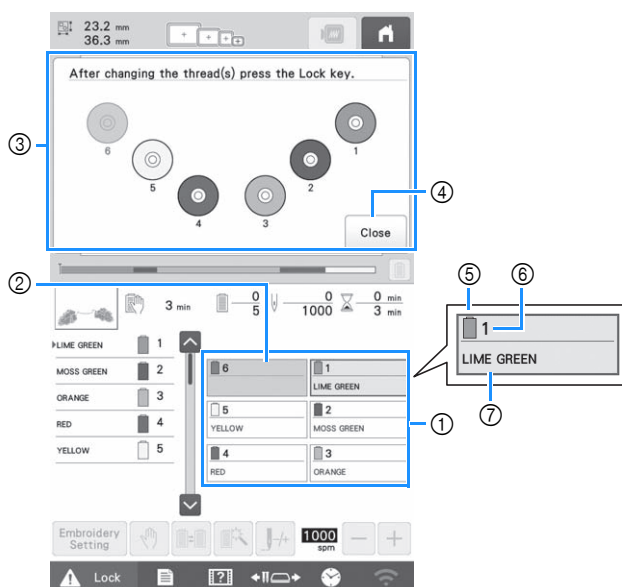

- ① Thread information for the first to sixth needle bars
- ② If no thread color name is displayed, that needle bar has not been used.
If a thread color had been assigned to the needle bar on a previously embroidered design, the needle bar will show the previously assigned color.
- ③ Screen indicating that the spools be changed. (page 87)
This message appears when it is necessary for the thread spools to be changed.

Memo

- The thread spools for needle bars whose keys do not appear in gray must be changed. When the automatic needle-threading button is pressed, the needle bar keys appear in gray.
- ④ Minimize the screen indicating that the spools be changed to .
 - ⑤ Thread color
 - ⑥ Needle bar number
 - ⑦ Thread color name or number
If the thread color number [#123] is selected in the settings screen, the thread brand will also be displayed. (page 109)

Thread with the color name that appears below each needle bar number is threaded on that needle bar.

① Touch .

→ Current assigned colors are stored in the machine's memory, and the screen indicating that the spools be changed is minimized to .

- In addition to checking the thread colors, information such as the number of stitches and the embroidering time can be checked, and various embroidering settings can be specified in the embroidering screen.

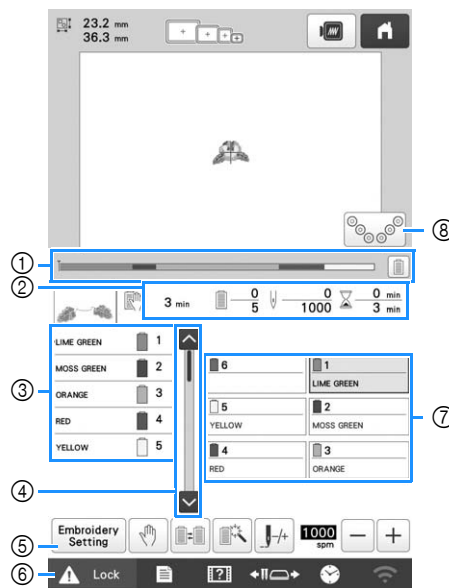

- ① The embroidering progress is shown by the red mark in the bar. Touch to display (in the indicator) only the thread color being embroidered.
- ② Shows the length of time until the machine will stop, the number of thread color changes, the number of stitches, and the total embroidering time.
- ③ Shows the thread colors, embroidering order and number of the needle bar assigned to the thread colors. A red triangle appears beside the thread color being embroidered. In addition, the parts where embroidering is finished change to gray and scroll up.
- ④ Touch and to view the embroidering order and needle bar number for thread colors that cannot be seen in the screen.
- ⑤ Return to the embroidering settings screen.
- ⑥ When starting the machine or cutting the threads, touch this button to unlock the machine, and then press the "Start/Stop" button or thread trimming button.
- ⑦ Touch a key to move the selected needle bar to the embroidering position. Use when threading the needle with the automatic needle-threading mechanism.
- ⑧ Displays screen indicating that the spools be changed.

Memo

- Available keys are not the same if you set [Manual Color Sequence] to [ON] in the settings screen. (page 60)

⚠ CAUTION

- When  (unlock key) in the embroidering screen is touched, the “Start/Stop” button begins flashing in green and the machine can start embroidering. If the upper threading is being performed or the needle is being threaded, be careful that the machine is not accidentally started, otherwise injuries may result.

Upper threading

Use machine embroidery thread to thread the needle bars in order, starting with needle bar 1.

⚠ CAUTION

- When threading the upper thread, carefully follow the instructions. If the upper threading is not performing correctly, the thread may break or become tangled, causing the needle to bend or break.

💡 Note

- It is recommended that rayon or polyester machine embroidery thread be used (120 den/2, 135 dtex/2, 40 weight (in Americas and Europe), #50 (in Japan)).
- Certain types of thread may break or have improper tension. In such a case, change the thread.
- The path that the machine should be threaded is indicated by a line on the machine. Be sure to thread the machine as indicated.

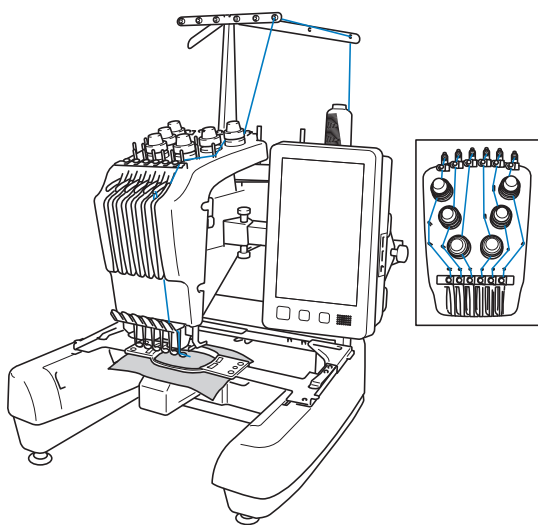

- 1 On the spool pin 1, place a spool with the thread color specified for the spool pin 1.

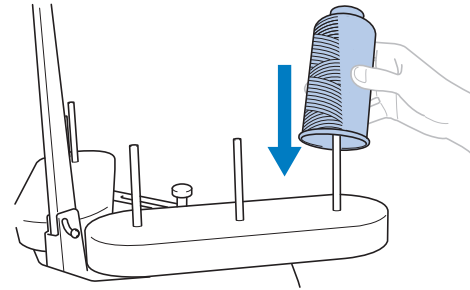

- When using thread that winds off quickly, such as metallic thread, place the included spool net over the spool. If the spool net is too long, fold it once to match the size of the spool before placing it over the spool. It may be necessary to adjust thread tension when using the spool net.

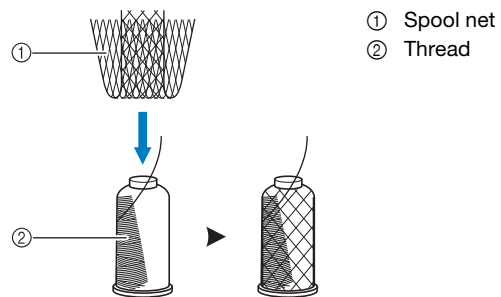

- Make sure that the spool stand is opened in the shape of a V.
- When using small spools of thread, be sure to place the included spool mat on the spool pin before placing the spool on the pin.
- Place the thread in the center of the spool stand so that the thread feeds off of the spool correctly and does not get tangled around the spool pin directly under the thread spool.

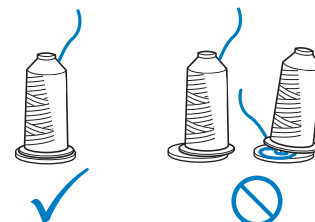

- Use spool cap on all spools of thread shorter than the height of the spool pin.

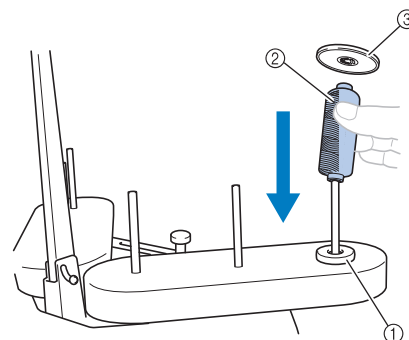

- ① Spool mat
- ② Small spool
- ③ Spool cap

The numbers indicate the thread path for each of the numbered needle bars. Be very careful to correctly thread the needle bars.

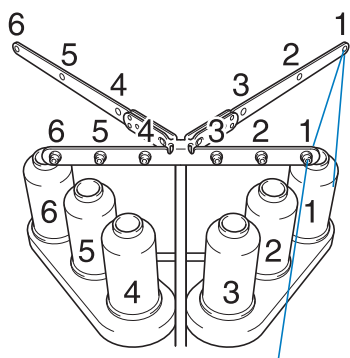

- 2** Pass the thread through the number 1 hole in the thread guide just above the spool, and then pass the thread through the number 1 hole in the thread guide toward the front of the machine.

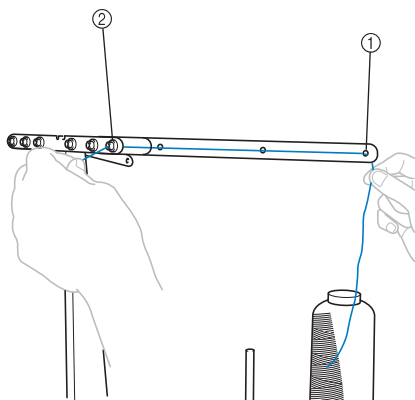

- ① Number 1 hole in the thread guide above the spool
- ② Number 1 hole in the thread guide toward the front of the machine

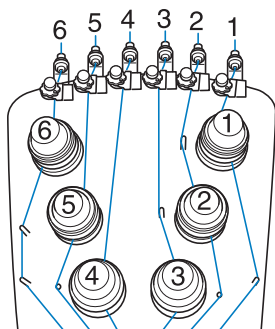

- 3** Pass the thread through the hole in the number 1 upper thread guide and pull the thread toward you.

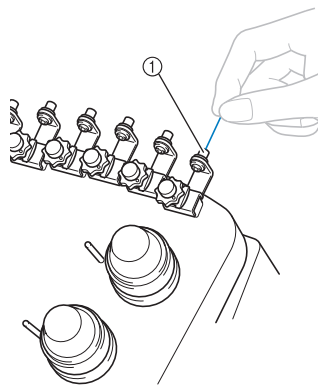

- ① Hole in upper thread guide

- 4** Hold the thread with both hands, and then pass it under the guide plate from the right.

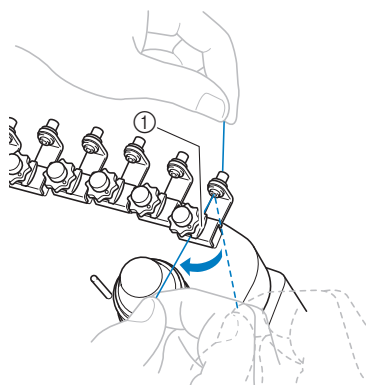

- ① Upper thread guide plate

- 5** Wind the thread clockwise once around the number 1 thread tension disc.

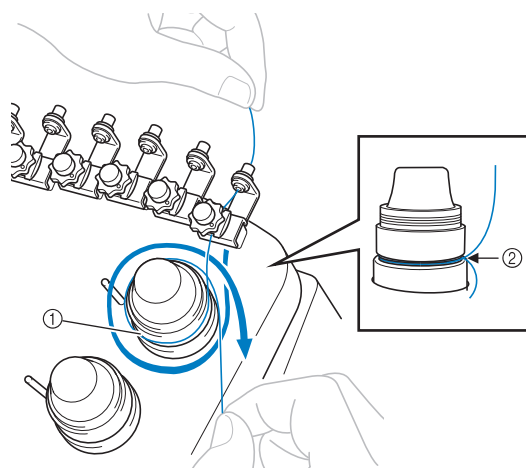

- ① Thread tension disc
- ② Pass thread in a clockwise direction at this location on the tension disc.

- Make sure that the thread is securely positioned in the thread tension disc.

Note

- All thread tension discs are threaded in clockwise direction.

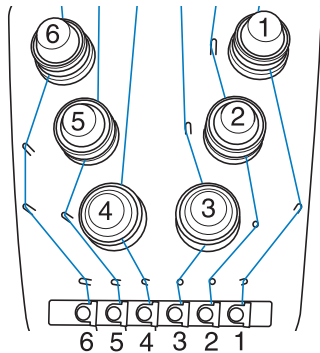

- 6** Lead the thread along the thread path and around the correct thread guide pins as indicated on the machine.
- 7** Slip the thread under the number 1 middle thread guide plate from the right.

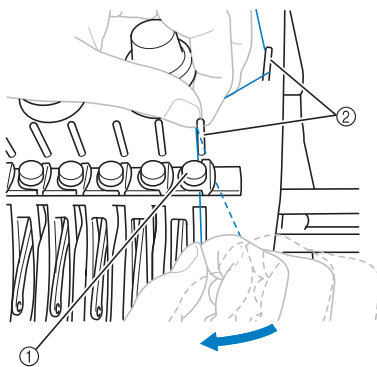

- ① Middle thread guide
- ② Thread guide pin

- The path from the upper thread guide around the thread tension disc and to the middle thread guide (steps 5 through 7) differs depending on the spool number. Passing the thread from the left to the right through the thread guide pins is designed to prevent the thread from becoming tangled. Be sure to follow the thread path indicated on the machine.

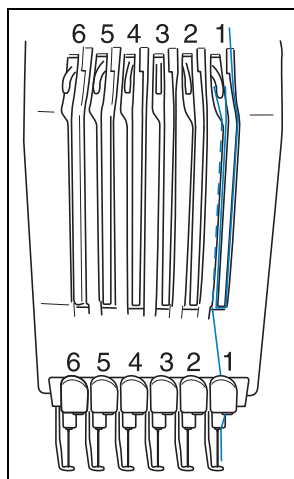

- 8** Pass the thread along the number 1 slot to pass it through the number 1 take-up lever hole from right to left.

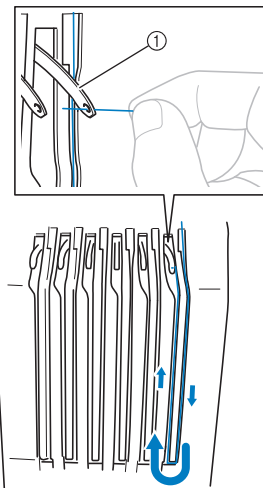

- ① Thread take-up lever

- 9** Pass the thread down through the slot to the lower thread guide, and then through the hole in the number 1 lower thread guide.

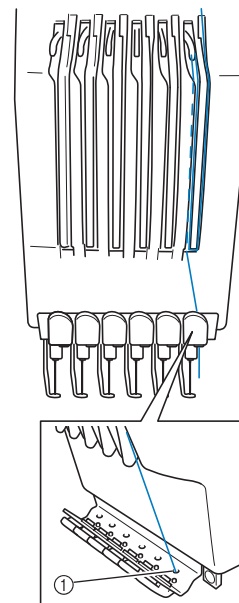

- ① Hole in lower thread guide

- 10** Use the included needle changing tool (threader) to pass the thread into the number 1 needle bar thread guide.

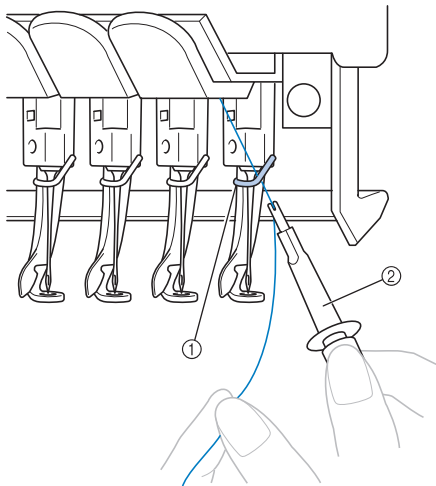

- ① Needle bar thread guide
② Needle changing tool (Threader)

Threading the needle

Use the automatic needle-threading mechanism to thread the needle.

Note

- The automatic needle-threading mechanism can thread one needle at the embroidering position. When this mechanism is used, be sure that the needle bar that you want to thread is positioned at the embroidering position, otherwise the automatic needle-threading mechanism cannot be used at the particular needle. If the needle bar is not at the embroidering position, move it there. (page 81)

- 1** Press the automatic needle-threading button.

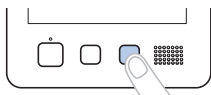

→ The hook on the automatic needle-threading mechanism passes through the eye of the needle.

CAUTION

- If the needle is not fully inserted, the hook of the automatic needle-threading mechanism will not pass through the eye of the needle during automatic needle threading, and the hook may bend or the needle cannot be threaded.
- If the hook of the automatic needle-threading mechanism is bent or damaged, contact your authorized Brother dealer.
- While the hook of the automatic needle-threading mechanism is passed through the eye of the needle, do not rotate the handwheel. The automatic needle-threading mechanism may be damaged. If you turn the handwheel, the automatic needle-threading mechanism will return to its initial position to avoid damage.

- 2** Pull out about 15 cm (6 inches) of thread. Then, as shown in the illustration, pass the thread under the fork of the automatic needle-threading mechanism from the right, and then catch the thread with the hook that passes through the eye of the needle.

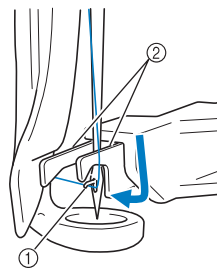

- ① Hook
② Fork

Note

- When catching the thread with the hook, be careful that the thread does not become loose.

- 3** Pass the thread under the guide on the presser foot.

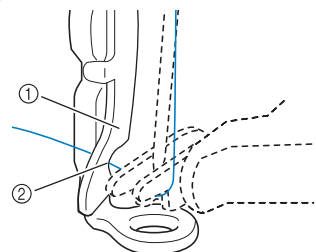

- ① Guide on presser foot
② Notch in guide on presser foot

- Make sure that the thread securely passes through the notch in the guide on the presser foot.

4 Securely pass the thread through the groove in the thread cutter, and then lightly pull the thread to cut it.

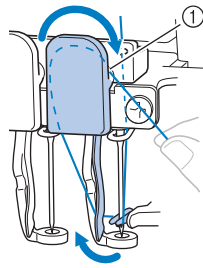

① Groove in thread cutter

Note

- If the thread is not correctly passed through the groove in the thread cutter, the message [Wiper error] appears and the needle cannot be threaded. Be sure to securely pass the thread through the groove.
- Pull out enough thread. If enough thread is not pulled out, the thread cannot be pulled through the thread cutter.

Memo

- The Wiper is the mechanism for pulling the thread to back when the needle threader is used and when the thread is trimmed during embroidery.

5 Press the automatic needle-threading button.

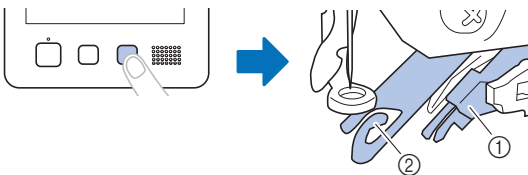

① Automatic needle-threading mechanism
② Wiper

- The threader moves back away from the needle. The thread is pulled through the needle eye.
- The wiper comes out and catches the thread between the needle and the threader.
- The threader goes back to the original home position.

This completes the upper threading for needle bar 1. Thread the remaining needle bars in the same way.

Note

- If the needle bar to be threaded is not moved to the embroidering position, the needle cannot be threaded with the automatic needle-threading mechanism. For the remaining needle bars, perform the following operation to move the needle bar to the embroidering position before trying to thread the needle.
- If the thread is not taut, it may come out of the thread tension disc. After upper threading is finished, check again to make sure that the thread is correctly passed into the thread tension disc. (step 5 on page 78)

Moving and threading a selected needle bar

You can move and thread a selected needle bar to the embroidering position at any time.

1 Touch .



→ The needle bar move screen appears.

2 Touch the key for the needle bar that you wish to move or thread.

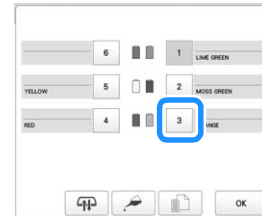

→ The selected needle bar moves to the position for threading.

3 Press the automatic needle-threading button while the needle bar move screen appears.



Memo

Additional methods to move the needle bar:

- In the embroidering screen, touching the number of the needle bar to be threaded will move the needle bar to the threading position.



- In the threading diagram at the top of the screen, touching any spool other than those shown in gray will also move the corresponding needle into position for threading.

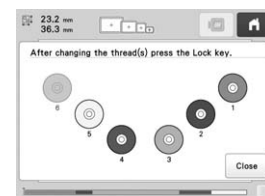

4 Touch **OK** to return to the previous screen.

Memo

- In the embroidering screen, a blue frame appears around the thread information box of the selected needle bar.



- When changing one of the upper thread colors, it is easy to re-thread by cutting the thread currently being used between the spool and the thread guide above the spool. Place the new spool on the spool pin and tie the end of the new thread to the end of the previous thread. Then pull the thread through to the needle (page 88).

PERFORMING THE EMBROIDERY

Memo

- With the Monitoring App [My Stitch Monitor] installed on your smart device and the machine and smart device connected to the same wireless network, you can check the operating status of the machine. (page 33)

Now, the machine is ready to begin embroidering. When the machine starts embroidering, the presser foot is automatically lowered, the necessary thread trimming operations at the beginning of stitching and at the end of stitching are performed, the threads are changed as necessary while the embroidery is performed, and the machine stops when the end of the stitching is reached.

CAUTION

- For safety reasons, the machine must not be left unattended while it is embroidering.
- While the machine is in operation, pay special attention to the needle location. In addition, keep your hands away from all moving parts such as the needle, needle bar case, thread take-up lever and carriage, otherwise injuries may result.
- When embroidering overlapping stitches, it is difficult for the needle to penetrate the fabric, possibly resulting in the needle bending or breaking.

Starting embroidering

Note

- Make sure that there are no objects within the moving area of the embroidery frame. If the embroidery frame hits another object, the pattern may become misaligned.
- When embroidering large pieces of fabric, make sure that the fabric is not caught in the carriage.

1 Touch **Lock** to unlock the machine.

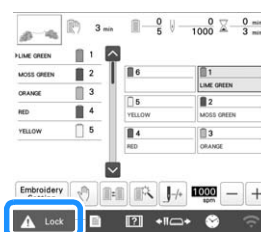

- The "Start/Stop" button changes from lit in red (locked machine) to flashing in green (unlocked machine), and the machine is ready to begin embroidering.
- If the "Start/Stop" button is not pressed within 10 seconds after unlocking the machine, the machine becomes locked again.

2 Press the “Start/Stop” button.

Press the “Start/Stop” button while it is flashing in green. If the “Start/Stop” button returns to being lit in red, perform this procedure again from step 1.

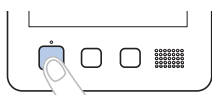

→ The “Start/Stop” button lights up in green and begins embroidering the first color.



① The thread color for the needle bar that is currently being used for embroidery or will soon be used for embroidery appears at the top of the thread color sequence display. The remaining thread colors are listed in embroidering order, starting from the top.

② A blue frame appears around the thread information box of the needle bar currently being selected.

- While the machine is embroidering, the point being embroidered is indicated by the green cross hairs in the pattern display area. In addition, the number of stitches and the time count up.

3 After embroidery of the first color is finished, the machine automatically stops and trims the thread. The needle bar case moves to the second color position and embroidery of the second color begins.

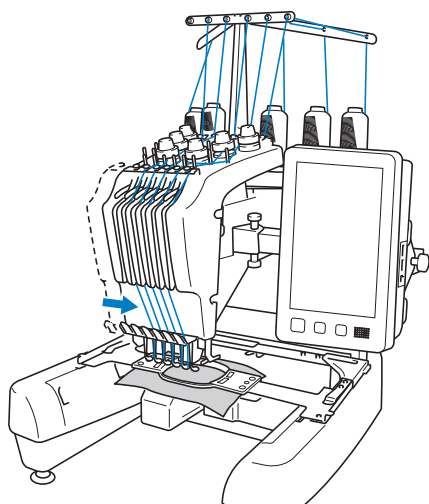

→ The thread color display in the screen continues to the second color, and the thread information for the second needle bar is surrounded by the blue frame.

4 This continues until the last color is embroidered, and the machine automatically stops.

→ The embroidering settings screen reappears.

→ The “Start/Stop” button lights up in red.

- No thread trimming operations at the beginning of stitching and at the end of stitching are necessary.

Memo

- When embroidering a pattern that contains seven or more colors, it is necessary to change the thread spools. (page 86)

Continuing embroidering

To embroider the same pattern again, touch **Embroidery**.

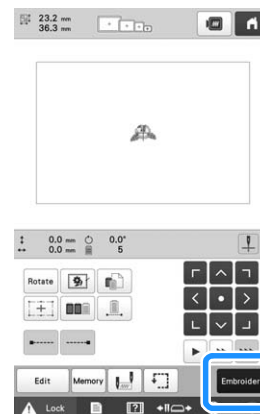

→ The embroidering screen appears so the same pattern can be embroidered again.

To select a new pattern, touch **Home**.

→ The pattern type selection screen appears.

Memo

- Automatic lock stitch setting can be set so that it is performed at the beginning of the embroidery, when starting to embroider after changing thread colors, and when trimming the thread. (page 72)

Stopping embroidering

The machine can be stopped during embroidering.

Temporarily pausing

1 Press the “Start/Stop” button.

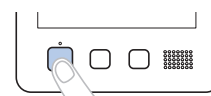

→ The machine stops and the “Start/Stop” button lights up in red.

- Embroidering can also be stopped by touching an area displaying the pattern.
- The thread is not trimmed.
- To continue embroidering, after checking that the upper thread is taut, touch the unlock key, and then press the “Start/Stop” button.

Memo

- If the reserve stop key is touched while embroidery is being performed, the machine stops embroidering before the next color begins. (page 105)
- Before starting to embroider, the machine can be set to stop at any thread color change. (page 105)

■ Temporarily pausing for extended periods of time

1 Press the "Start/Stop" button.

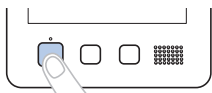

→ The machine stops and the "Start/Stop" button lights up in red.

- The thread is not trimmed.

2 Touch to unlock the machine.

3 Press the thread trimming button.

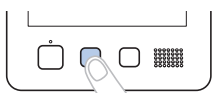

→ The bobbin and upper threads are trimmed.

- Before turning off the machine, be sure to trim the threads.

4 Set the main power switch to "O" to turn off the machine.

→ The display and the "Start/Stop" button indicator go off.

- Embroidery can resume after the machine is turned on again. Back up several stitches to overlap the stitching. (page 92)

Memo

- The machine can be stopped at any time, even while it is embroidering; however, if the machine is stopped at a thread color change, it is not necessary to go back through the stitching when embroidering is continued. The machine can be set to stop when the thread color is changed. (page 105)





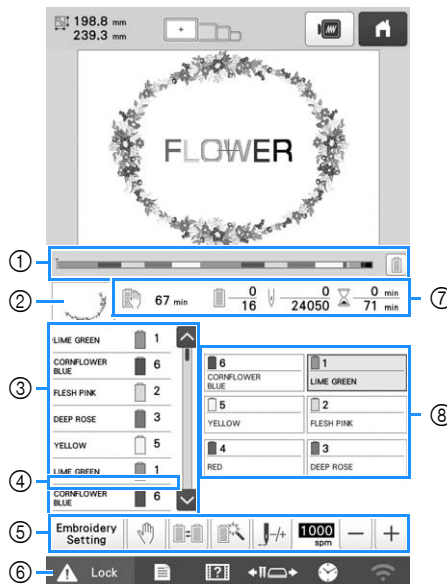

■ If the thread breaks while embroidering

If a problem occurs while embroidering, such as if the thread breaks, the machine stops automatically. Re-thread the broken thread, back up several stitches, and then continue embroidering. (page 89)

Understanding the embroidering screen

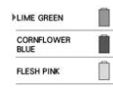
From this screen, the total number of thread colors, the embroidering order and embroidering time can be checked, the needle bar settings can be specified, and the needle placement forward or backward can be done. Keys available in this screen differ when you set [Manual Color Sequence] to [ON] in settings screen. (page 60)



No.	Display Key Name	Function	Page
①	 Progress bar	The embroidering progress is shown by the red mark in the indicator. Touch  to display (in the indicator) only the thread color being embroidered.	—
②	 Region display	Shows the part of the pattern that will be embroidered with the thread color shown first in the thread color sequence display.	—
③	 Thread color sequence display	Shows the order for the thread color changes. During embroidering, this display scrolls automatically so that the color of the thread currently being embroidered appears at the top.	—
	$\frac{1}{6}$ $\frac{2}{2}$ Needle bar number	Indicates the needle bar number where the thread color at the left is assigned.	—
	  Scroll bar	The thread color sequence display shows the first seven thread colors. To check the sequence for the eighth and later thread colors, touch  or  , or touch the scroll bar.	—

No.	Display Key Name	Function	Page
④	Spool change indicator	This red line indicator shows when the thread spools will need to be changed.	87
	Embroidery setting key	Quit embroidering and return to the embroidering settings screen.	—
⑤	Reserve stop key	While embroidering, touch this key for the machine to stop prior to the next color beginning.	105
	Switch spool key (Not available in the [Manual Color Sequence] mode)	Change the needle bar settings from the screen without changing the thread spools on the machine.	58
	Temporary needle bar settings key	Enable the needle bar settings to manually be specified.	106
⑥	Forward/Backward stitch key	Move the needle forward or backward through the stitching. Use this key in the following situations: <ul style="list-style-type: none"> • If the thread breaks or runs out while embroidering • To restart embroidering from the beginning • To continue embroidering after the machine was turned off 	89
	Maximum embroidery speed key	Specify the maximum embroidery speed. <ul style="list-style-type: none"> • Specify a low speed for thin, thick or heavy fabrics. • When using a weak thread such as metallic thread, specify an embroidery speed of 400 spm. 	156
⑦	Lock	Unlocks the machine so it can start embroidering within 10 seconds. When this key is touched, the "Start/Stop" button flashes in green.	82
	Unlock key		

No.	Display Key Name	Function	Page
⑦	67 min	Shows the amount of time until the machine will stop. When the last thread spool is being embroidered, the number appears in red. If the thread color needs to be changed, this shows the time until the thread spool will need to be changed.	86
	Time until the machine stops		
	0 / 16	The bottom value shows the total number of thread colors in the pattern and the top value shows the thread color that is currently being embroidered.	—
	Embroidering order		
	0 / 24050	The bottom value shows the total number of stitches in the pattern and the top value shows how many stitches have already been embroidered.	—
	Stitch count		
0 min / 71 min	The bottom value shows the total amount of time required to embroider the pattern and the top value shows how much time has already passed embroidering.	—	
Embroidering time			
⑧	1 LIME GREEN	Move the needle bar position to the selected needle bar number. Use when threading the needle with the automatic needle-threading mechanism.	—
	Needle bar key		
	Thread color set up display	Shows the color and the thread color name (number) for the thread on the needle bar indicated on the key. Thread the machine as indicated here.	76

Memo

- The thread color numbers in the thread color sequence display and the thread color set up display can be changed, for example, to the color name or the thread color number for other brands. (page 109)

REMOVING THE EMBROIDERY FRAME

⚠ CAUTION

- When removing the embroidery frame, make sure that the “Start/Stop” button is lit in red. If the “Start/Stop” button is flashing in green, the machine may start embroidering. If the machine accidentally starts operating, injuries may result.
- When removing the embroidery frame, be careful that the embroidery frame does not hit any other part of the machine.
- Do not lift up the embroidery frame holder with extreme force, otherwise it may be damaged.

- 1 With both hands, grab the left and right sides of the arms of the embroidery frame holder, and then slightly lift up the frame.

The pins on the arms of the embroidery frame holder should come out of the holes in the sides of embroidery frame.

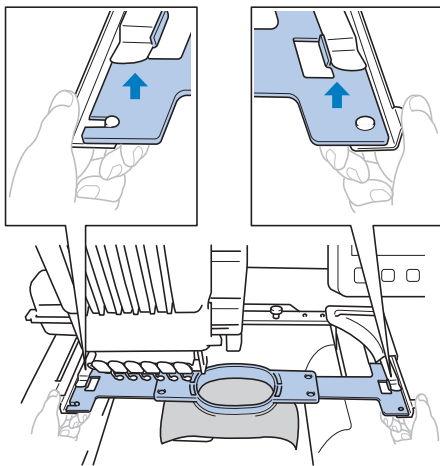

- 2 Pull off the embroidery frame toward you.

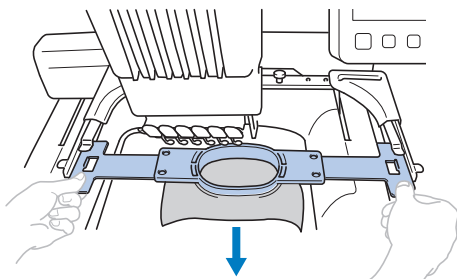

→ Remove the fabric from the frame.

EMBROIDERING A PATTERN CONTAINING SEVEN OR MORE COLORS

When embroidering a pattern that uses seven or more thread colors, it is necessary to change the thread spools. When changing the thread spools, instruction to change the thread spools will appear with the machine automatically stopping.

📄 Memo

- This function is not available when you set [Manual Color Sequence] to [ON] in settings screen.

Checking if thread spool changes are necessary

When selecting a pattern, the number of thread changes can be viewed; however, which thread colors are used in the pattern cannot be checked on this screen. Whether or not, and when, thread spools will need to be changed can be checked with the following indicators.

■ Time until the machine stops embroidering

This indicator shows the amount of time until the machine stops embroidering. The machine stops when a spool change is required or when the machine is set to be stopped by other settings.

If the spool change indicator appears, the machine will require a spool change. When the time is indicated in red, it is the last color embroidering before the machine stops.

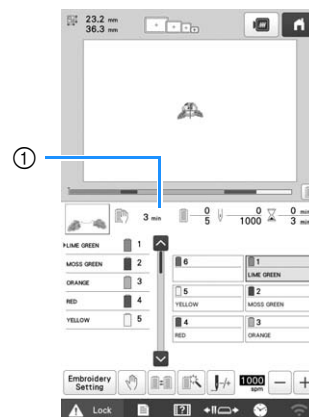



- ① Time until the machine stops

■ Spool change indicator (—)

The spool change indicator in the stitch navigating screen indicates the number of times that the thread spools will need to be changed and the amount of time between changes.

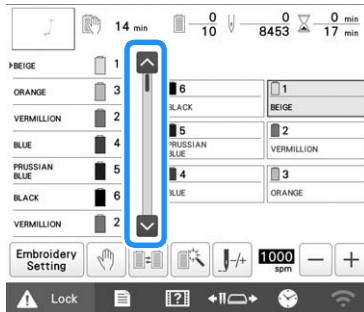
- 1 Use the scroll bar on the right side of the thread color sequence display in the embroidering screen.



→ Each time  is touched, the thread color sequence display scrolls down to the next color. After reaching the last color in the thread color sequence display, the first color is selected.

- 2 Check the position of .

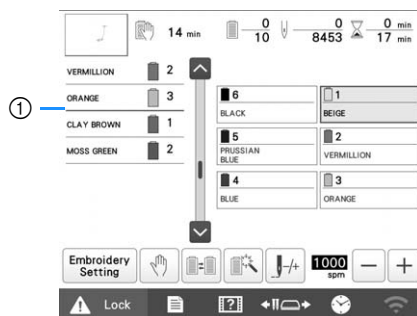

①  indicates when the thread spools will need to be changed. The thread spools will need to be changed the number of times that this indicator is displayed and between the two thread colors at the point where it is displayed.

- 3 After checking the desired information, touch  or the top of the scroll bar to return to the first color.

CHANGING THE THREAD SPOOLS

This section provides details on the spool thread indicators in addition to the procedure for easily changing the spools.

Memo



- This feature is not available if [Manual Color Sequence] has been set to [ON] in the settings screen.

About spool thread indicators

When it is necessary to replace the thread spool, the machine automatically stops embroidering and the screen shown below appears.

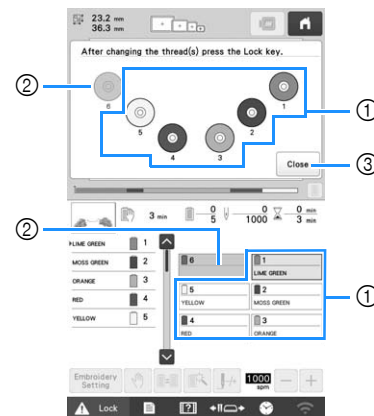
In addition, when a new pattern is selected, the screen shown below appears. Change the thread spools according to their new assignments.



- ① The thread spools needing to be changed appear in other than gray.
- ② The thread spools needing not to be changed appear in gray.
- ③ Minimize the screen indicating that the spools be changed to . To display the screen again, touch .

Note

- Touch needle bar key to move the needle into the correct position for threading with the new thread color. (page 81)
- When the embroidering screen appears, the needle bar settings are saved.
- If the needle bar settings are saved and the next pattern that is opened contains thread colors that are the same as those from the previous pattern, the needle bars will be assigned the same thread colors from the previous pattern.
- If you wish to delete all assigned colors on display, refer to "To cancel the thread color settings for all previously stitched design" on page 59.

Memo

- To use a different thread color than the one that was specified, use the temporary needle bar thread setting key, and then change the thread color setting. (page 106)
- To minimize changing the thread spools, frequently used thread colors can be specifically assigned to certain needle bars. (page 107)

Easily changing the thread spools

When replacing the thread spools, it is necessary to re-thread the upper thread. However, the thread spools can easily be changed when replacing a thread spool whose thread is correctly threaded through the machine.

- 1** Cut the thread between the thread spool and the thread guide.

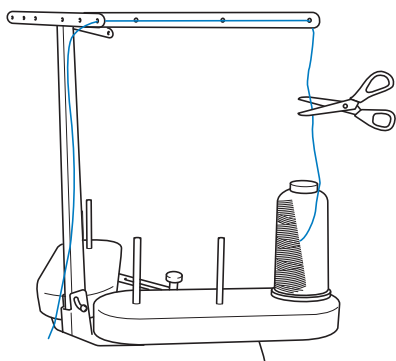

- 2** Change the thread spool.

- 3** Tie the end of the thread on the new spool with the end of the thread remaining from the previous color.

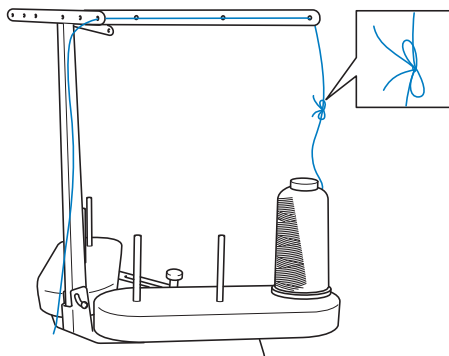

- 4** Pull out the old thread just after the needle bar thread guide.

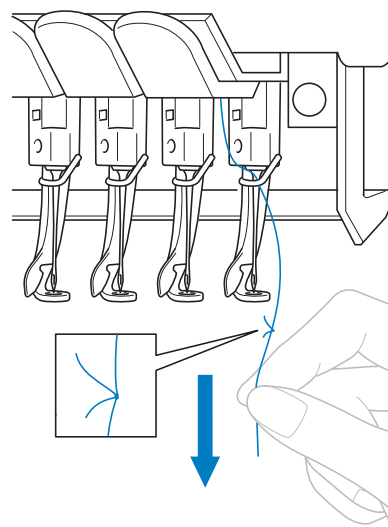

Continue pulling the thread until the knot is below the needle. Cut the knot.

- 5** Use the automatic needle-threading mechanism to thread the needle with the new thread. (page 80)

→ This completes the changing of the thread spool.

Note

- When pulling out the thread, do not pull the knot through the eye of the needle. If the knot is pulled through the eye of the needle, the needle may be damaged.

ADJUSTING WHILE EMBROIDERING

If the thread breaks or the bobbin thread runs out while embroidering

If the thread breaks or the bobbin thread runs out while embroidering, the machine will automatically stop. Since some stitches may be embroidered with only one thread, go back through the stitching to a point prior to the stoppage before continuing embroidering.

Note

- If [Thread Sensor] is set to [OFF], the machine does not stop until embroidering is finished. Normally, the [Thread Sensor] should be set to [ON].
- Be careful when going back or forward through the stitching since the embroidery frame moves at the same time.



■ If the upper thread breaks

1 Re-thread the upper thread. (page 77)

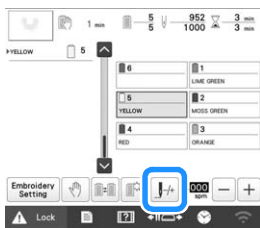
2 Touch .



→ The stitch navigating screen appears.

3 Touch  and  to go back through the stitching to a point where stitches have already been embroidered.

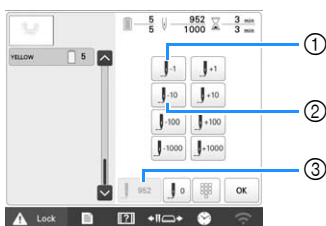



- ① Each touch of this key moves one stitch back through the stitching.
- ② Each touch of this key moves ten stitches back through the stitching.
- ③ Touch this key to cancel the changes and return to the point in the stitching before the changes.

Note

- It is recommended to stitch over the top of the last two or three stitches for complete coverage.

You can also touch the specific point of the embroidery progress bar to move the stitch count to the desired point.

If the needle bar is moved back too far through the stitching, touch  or  to go forward through the stitching.

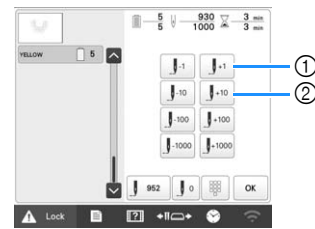

- ① Each touch of this key moves one stitch forward through the stitching.
- ② Each touch of this key moves ten stitches forward through the stitching.

4 Touch .

→ The embroidering screen appears again.

5 Touch , and then press the “Start/Stop” button to continue embroidering.

■ Specifying a stitch number

1 Touch .

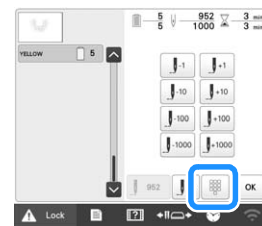

2 Use the number keys to enter the desired stitch number, and then touch .

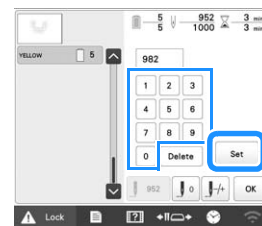



→ The embroidery frame moves to the specified stitch.

3 Touch .

→ The embroidering screen appears again.

4 Touch , and then press the “Start/Stop” button to continue embroidering.

Memo

- Touch  to reset the stitch number and embroider from the first stitch.
- To specify the last stitch number, select the last thread color, and then touch .

■ If the bobbin thread breaks or runs out

- 1 Touch , and then press the thread trimming button.

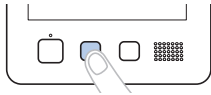

→ The upper thread is trimmed.

- 2 Remove the stitches embroidered only with the upper thread.

Pull the trimmed end of the upper thread.

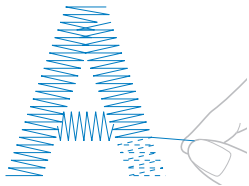

- If the stitches cannot be cleanly removed, trim the thread with scissors.

■ If the bobbin thread ran out, replace the bobbin at this point in the procedure.

- 3 Replace the bobbin with a bobbin wound with bobbin thread. (page 35)

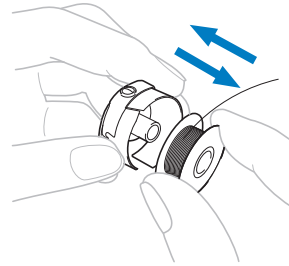

- If the hook cover can be opened, replace the bobbin without removing the embroidery frame from the machine.
- If the machine bed is hidden, for example, with a bag-shaped piece of fabric, or if the hook cover cannot be opened, temporarily remove the embroidery frame. (page 86) After replacing the bobbin, re-attach the embroidery frame. (page 66)

Note

If the embroidery frame is removed before embroidering of the pattern is finished, take caution, otherwise the pattern may become misaligned.

- Do not apply extreme pressure to the framed fabric and cause it to become loose.
- When removing and re-attaching the embroidery frame, do not allow the frame to hit the carriage or the presser feet.
If the carriage is hit and moves, turn the machine off, then on again. The correct frame position at the time that the machine was stopped is stored in the machine's memory, and the embroidery frame is returned to the correct position.
- When the embroidery frame is re-attached, make sure that the pins on the left and right arms of the embroidery frame holder securely fit into the holes in the handles on the embroidery frame.

- 4 Go back through the stitching in the same way as that described in step 2 through 5 of "If the upper thread breaks" on page 89, and then continue embroidering.

Embroidering from the beginning or middle of the pattern

If you wish to restart embroidering from the beginning, for example, if trial embroidery was performed and an incorrect thread tension was used or if the wrong thread color was used, restart the embroidering using the forward/backward stitch key. In addition, you can go forward or back through the stitching by thread color or by stitch to start stitching at any position of the pattern.

Note

- Be careful when going back or forward through the stitching since the embroidery frame moves at the same time.

1 Press the “Start/Stop” button to stop the machine.

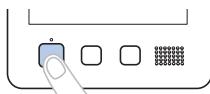

- If necessary, trim and remove the embroidered stitches.

2 Touch .

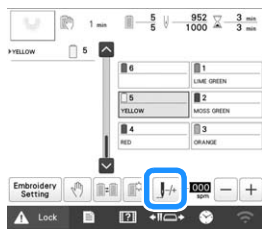

→ The stitch navigating screen appears.

3 Use the scroll bar to select the thread color, and then touch , , , , , , and to select the specific stitch.

- Touch to embroider from the beginning.

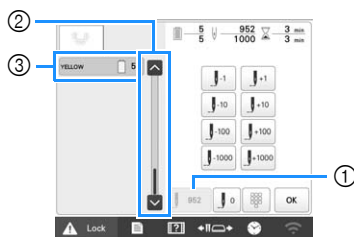

- 1 Touch this key to cancel the changes and return to the point in the stitching before the changes.
- 2 The stitch from where embroidering is to begin can also be specified by using the scroll bar.
- 3 The thread color at the top of the thread color sequence display is the color of the area currently selected. Touch this area to specify the stitch from where embroidering is to begin.

→ The needle bar case moves and the current needle bar moves to the embroidering position, and then the embroidery frame moves and current needle position is indicated.

4 After selecting the stitch from where embroidering is to begin, touch .

→ The embroidering screen appears again.

5 Touch and then press the “Start/Stop” button to begin embroidering.

→ Embroidering begins from the specified point.

Specifying a stitch number

1 Touch .

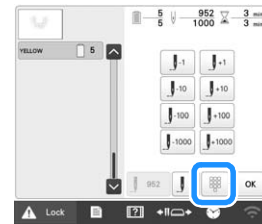

2 Use the number keys to enter the desired stitch number, and then touch .

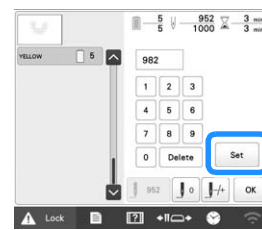

→ The embroidery frame moves to the specified stitch.

3 Touch .

→ The embroidering screen appears again.

4 Touch and then press the “Start/Stop” button to continue embroidering.

Resume embroidering after turning off the machine

In either of the following cases, the remaining stitches of the embroidery are stored in the machine's memory.

- If the machine's power switch is pressed to turn off before stopping embroidering:
Cut the thread before the machine's main power switch is turned off, otherwise the thread may be pulled or may catch when the carriage returns to its initial position after the machine is turned on again.
- If the machine was accidentally turned off, for example, due to a power outage, while it was embroidering:
The remainder of the embroidery can be performed when the machine is turned on again; however, some of the stitches that were already embroidered may be embroidered again.



- ① Cancel embroidering and display the pattern type selection screen to select a new pattern.
 - ② Continue embroidering.
- The embroidering screen displayed before the machine was turned off appears.

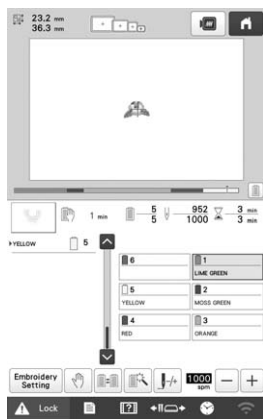

Note

- You may need to advance or reverse through the stitches to get to the correct needle drop position.

Chapter 3 ADVANCED EMBROIDERY

VARIOUS EMBROIDERY FUNCTIONS

Basting embroidery

Before embroidering, basting stitches can be embroidered along the outline of the pattern. This is useful for embroidering fabric that cannot have stabilizer material affixed with an iron or adhesive. By stitching stabilizer material to the fabric, shrinkage of the stitching or misaligned patterns can be minimized.

Note

- It is recommended to finish combining and editing the pattern before selecting the basting setting. If the pattern is edited after selecting the basting setting, the basting and pattern may become misaligned, and the basting under the pattern may be difficult to remove after embroidering is complete.

- 1 Touch .
→ The embroidery settings screen appears.
- 2 Locate [Basting Distance] in the Settings pages.
- 3 Use and to specify the distance from the pattern to the basting stitching.



Memo

- The higher the setting, the farther the basting is from the pattern.
- The setting remains selected even if the machine is turned off.

- 4 Touch to return to the embroidering settings screen.
- 5 Touch to select the basting setting.

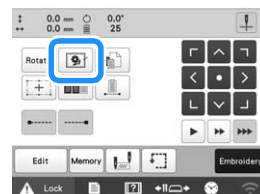

Note

- When is touched, the pattern is moved to the center. After selecting the basting setting, move the pattern to the desired position.
 - To cancel the setting, touch .
- Basting is added to the beginning of the embroidering order.

- 6 Touch to continue to the embroidering screen.
- 7 Touch , and then press the "Start/Stop" button to begin embroidering.
- 8 When embroidering is finished, remove the basting stitching.

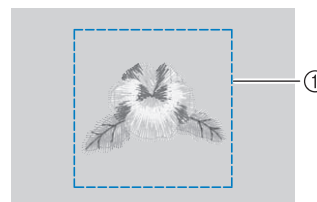

① Basting stitching

Embroidering appliqué patterns

Some of the built-in embroidery patterns can be used for embroidering appliqués. Follow the procedures described below to embroider appliqués using the patterns with [APPLIQUE MATERIAL], [APPLIQUE POSITION] or [APPLIQUE] in the region display at the top of the thread color sequence display.

[APPLIQUE MATERIAL], [APPLIQUE POSITION] and [APPLIQUE] are assigned to a specific needle bar number.

*Depending on the thread color display setting, the display

may appear as  (Appliqué Material), 

(Appliqué Position) or  (Appliqué).

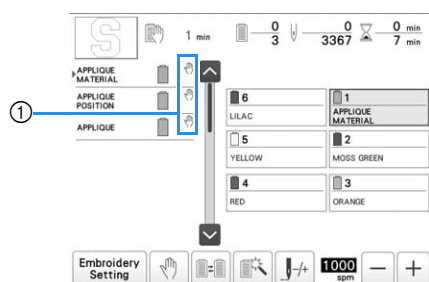

①  appears in the screen at places where the machine is stopped.

■ Procedure for embroidering appliqués

- 1 Place stabilizer on the back of the appliqué fabric/material.
- 2 Frame the fabric for the appliqué (from step 1) in the embroidery frame, and then embroider an [APPLIQUE MATERIAL] pattern. The line that indicates where the appliqué will be cut out is embroidered, and then the machine stops.

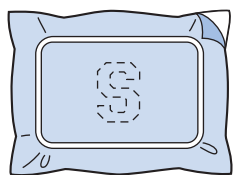

- 3 Remove the appliqué fabric from the embroidery frame, and then carefully cut along the embroidered cut line.

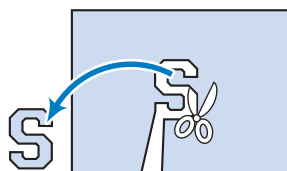

Note

- If the appliqué is cut out along the inside of the embroidered cut line, the appliqué may not be correctly attached to the fabric. Therefore, carefully cut out the appliqué along the embroidered cut line. If this step is not performed carefully, the appliqué will not be cleanly finished. In addition, carefully remove any excess threads.

- 4 Attach stabilizer material to the wrong side of the fabric for the appliqué base.
- 5 Frame the base fabric or garment in the embroidery frame, and then embroider an "APPLIQUE POSITION" pattern. The appliqué position is embroidered, and then the machine stops.

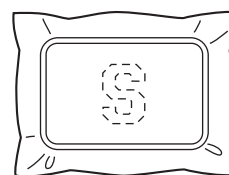

- 6 Lightly apply fabric glue or spray adhesive to the back of the appliqué piece that was cut out, and then attach the appliqué piece to the base fabric at the position embroidered using the [APPLIQUE POSITION] pattern in step 5.

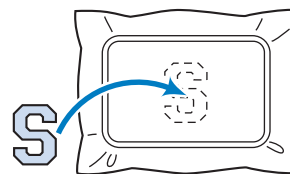

Note

- Do not remove the fabric from the embroidery frame when attaching the appliqué piece to the base fabric.

- 7 After attaching the appliqué piece, embroider an [APPLIQUE] pattern. The appliqué is finished.

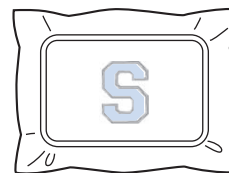

Memo

- Depending on the pattern, an [APPLIQUE] pattern may not be available. In this case, embroider the appliqué using thread in the color of a part of the embroidery.

Creating an appliqué piece

Appliqué pieces can be created from the built-in patterns and patterns from other sources. This is convenient for fabrics that cannot be embroidered or when you wish to attach an appliqué to a garment.

■ Creating an appliqué piece

The following pattern will be used to create an appliqué piece.

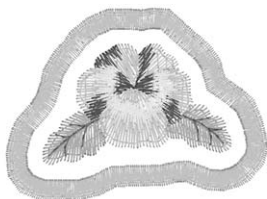

Note

- Felt or denim fabrics are recommended to make the appliqué piece. Depending on the pattern and fabric used, lighter weight fabrics may cause the stitching to appear smaller.
- For best results, be sure to use stabilizer material for embroidering.
- Select a frame that matches the pattern shape. Frame options are displayed on the LCD screen.
- Finish combining and editing the pattern before selecting the appliqué setting. If the pattern is edited after selecting the appliqué setting, the appliqué stitching and pattern may become misaligned.
- Since an outline is added, the pattern for an appliqué piece (when the appliqué setting is selected) will be larger than the original pattern. First, adjust the size and position of the pattern as shown below.

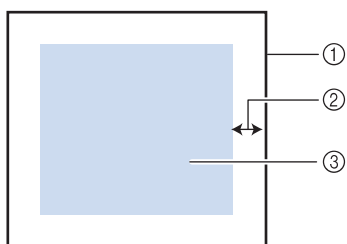

- ① Embroidering area
- ② Approx. 10 mm (3/8 inch)
- ③ Pattern size

1 Select the pattern to be used for the appliqué.

2 In the pattern editing screen, touch .

3 Select the outline.

If is selected, an outline is created which echoes the edges of the pattern.

→ Use or to specify the distance between the pattern and the appliqué outline.

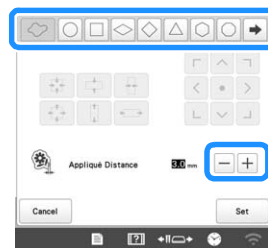

Memo

- If a frame pattern is selected for the outline, the frame pattern can be enlarged, reduced or moved.
- Touch to select a different outline pattern.

4 Check and adjust the preview in the screen, and then touch then .

Note

- At this time, the pattern and outline will be grouped.

5 After specifying the various settings, touch .

6 Specify the embroidering settings, and then touch to continue to the embroidering screen.

Memo

- Three steps are added to the embroidering order: appliqué cutting line, position of pattern placement on the garment, and appliqué stitching.

RED		4
YELLOW		5
APPLIQUE MATERIAL		6 ①
APPLIQUE POSITION		6 ②
APPLIQUE		6 ③

- ① Cutting line for appliqué
- ② Position of pattern placement on garment
- ③ Appliqué stitching (outline)

- We recommend using thread for the cutting line [APPLIQUE MATERIAL] that is closest to the color of the fabric.

7 Fuse or stick a piece of stabilizer to the back of the felt or denim fabric to be used as the appliqué piece.

8 Hoop the appliqué fabric in the embroidery frame, attach the embroidery frame to the machine, and then start embroidering.

9 After the cutting line [APPLIQUE MATERIAL] is embroidered, stop the machine and remove the appliqué material from the embroidery frame.

- 10 Carefully cut along the stitching. After cutting, carefully remove all of the cutting line thread.

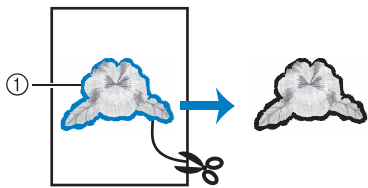

① Cutting line for appliqué

Note

- Depending on the pattern density and fabric used, there may be shrinking of the pattern or the appliqué may be misaligned with the placement line. We recommend cutting slightly outside of the cutting line.
- When using patterns that are vertically and horizontally symmetrical, use a chalk pencil to indicate the pattern orientation before cutting it out.
- Carefully cut out the pattern on the outline you just embroidered. Do not cut inside the cutting line, otherwise the appliqué fabric will not be caught by the appliqué stitch.

- 11 Use two layers of adhesive water-soluble stabilizer material with their sticky sides together, and then hoop them in the embroidery frame.

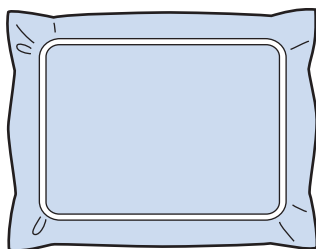

Note

- If water-soluble stabilizer is used, it is not necessary to remove the stabilizer material after embroidering the appliqué outline. To reduce shrinkage of the pattern, we recommend using water-soluble stabilizer.
- Put together two layers of water-soluble stabilizer, otherwise the stabilizer material may tear during embroidering.

- 12 Embroider the placement line for the appliqué position [APPLIQUE POSITION].

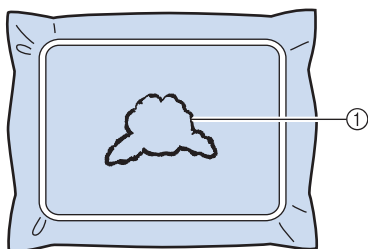

① Pattern placement line

- 13 Lightly apply glue or spray adhesive, and paste the appliqué piece so that it aligns with the placement line.

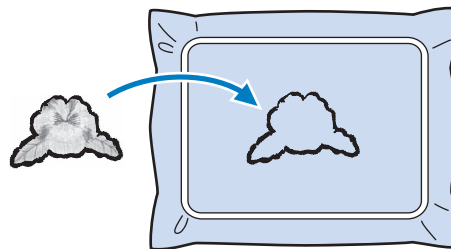

Note

- Before pasting the appliqué piece down, make sure the appliqué piece is positioned correctly within the placement line.

- 14 Embroider the outline [APPLIQUE].

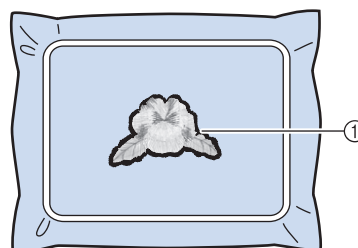

① Outline of appliqué piece

- 15 After embroidering is finished, remove the water-soluble stabilizer material from the embroidery frame.

- 16 Use scissors to cut the excess water-soluble stabilizer from outside the appliqué outline.

- 17 Soak the appliqué piece in water to dissolve the water-soluble stabilizer.

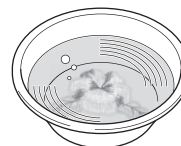

- 18 Dry the appliqué piece, and then iron it if necessary.

Note

- Do not apply a strong force when ironing, otherwise the stitching may be damaged.

Memo

- The outline is embroidered using satin stitching.
- Some glue may get onto the presser foot, needle, and needle plate at this time. Finish embroidering the appliqué pattern, and then clean off the glue.

Using a frame pattern to create appliqués

With this method, there is no need to change the fabric in the embroidery frame. The appliqué can be created by embroidering two frame patterns of the same size and shape—one embroidered with straight stitches and the other embroidered with satin stitches.

- 1 Select a frame pattern embroidered with straight stitches and embroider onto the base fabric.

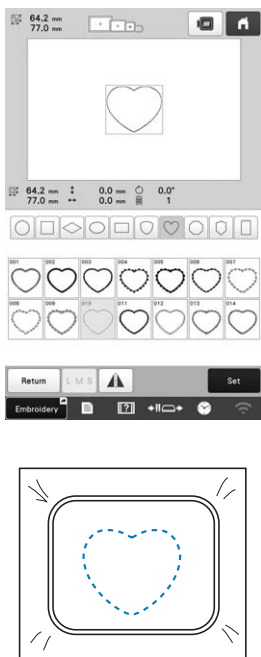

- 2 Place the appliqué fabric over the embroidery stitched in step 1. Make sure that the appliqué fabric is larger than the embroidered area.

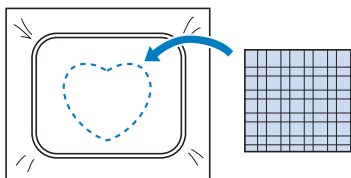

- 3 Embroider over the appliqué fabric using the same frame pattern.

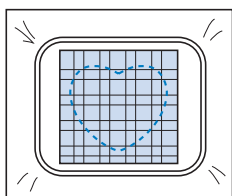

- 4 Remove the embroidery frame from the machine, and then cut off the excess appliqué fabric along the outside of the stitching.

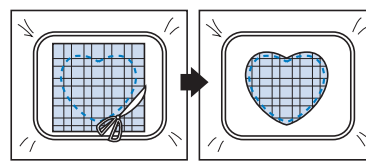

Note

- Leave the fabric in the embroidery frame when cutting off the excess appliqué fabric. In addition, do not apply extreme pressure to the framed fabric, otherwise the fabric could become loose.

- 5 Select the satin-stitched frame pattern with the same shape.

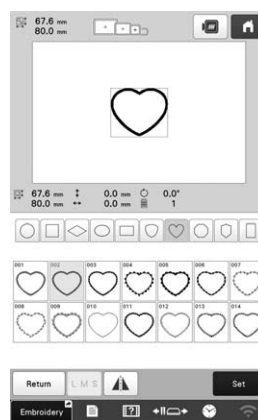

Note

- If the size or embroidering position of the straight-stitched frame pattern is changed, be sure to change the size or embroidering position of the satin-stitched frame pattern in the same way.

- 6 Attach the embroidery frame removed in step 4, and then finish embroidering the appliqué.

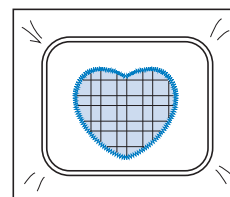

Creating stippling or echo quilting patterns automatically

Stippling or echo quilting patterns can be created around the machine's built-in patterns or original embroidery data.

1 Select the pattern that stippling will be added around.



2 Touch  in the pattern editing screen.

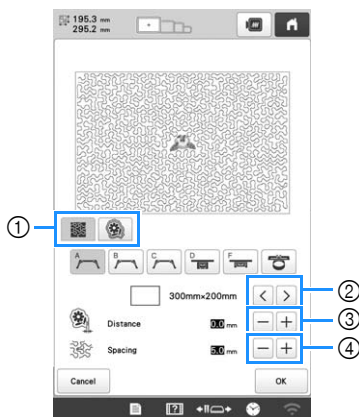

→ Stippling is automatically applied around the selected pattern.
To select multiple patterns, refer to page 44.

3 After specifying the stitch settings for the stippling, touch .



- ① To create a stippling pattern, touch . To create an echo quilting pattern, touch .
- ② If an embroidery frame size is selected, the stippling is added within the area of the selected frame size. If the pattern is larger than the selected frame size, the area indicating the frame size will appear in gray.
- ③ Specify the distance from the outline of the pattern to the stippling.
- ④ Specify the spacing for the stippling.

USING THE EMBROIDERY CROSSHAIR POSITIONING LASER FUNCTION TO ALIGN THE EMBROIDERING POSITION

By using the embroidery crosshair positioning laser function, the embroidering position can easily be aligned. This is useful when embroidering in an area where it is necessary to align the pattern, as shown below.

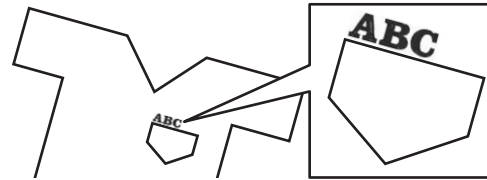

1 Use a chalk pencil to mark the desired embroidering position.

The line drawn for the reference direction should be longer.

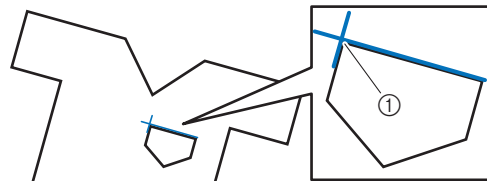

① Chalk pencil mark

Memo

- If the desired position of the pattern can be clearly established, such as when embroidering along a pocket, it is not necessary to mark the position with a chalk pencil.

2 Hoop the fabric in the embroidery frame.

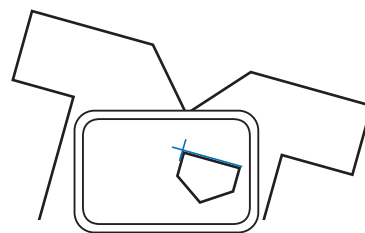

Note

- When hooping the fabric in the embroidery frame, make sure that the embroidery pattern will fit within the embroidering area of the frame being used.

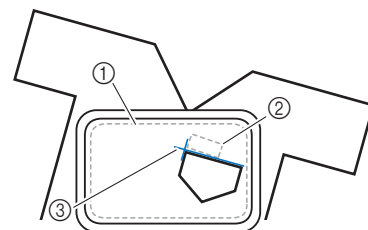

- ① Embroidering area
- ② Embroidery pattern size
- ③ Chalk pencil mark

- 3 Select the pattern.
- 4 Touch **Edit End** to display the embroidering settings screen.
- 5 Touch  in the embroidering settings screen.

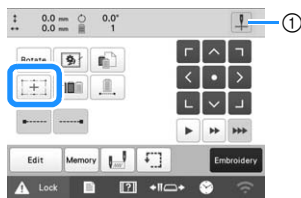

① Switch on/off the embroidery crosshair positioning laser.

Memo

- The embroidery crosshair positioning laser lights up to indicate the needle drop point.
- With certain types of embroidery frames, the embroidery crosshair positioning laser function cannot be used.
- If the surface of the fabric is too uneven or rough, check and adjust the alignment of the embroidery crosshair positioning laser and the needle drop point before starting to embroider.
- When using the cap frame, check and adjust the alignment of the embroidery crosshair positioning laser and the needle drop point before starting to embroider.

- 6 If a message appears, indicating that the move and rotate settings will return to the original ones, touch **OK**.

- 7 From the reference points shown in the screen, select the point to be used for aligning the pattern.
For this example, select the point in the lower-left corner of the pattern.

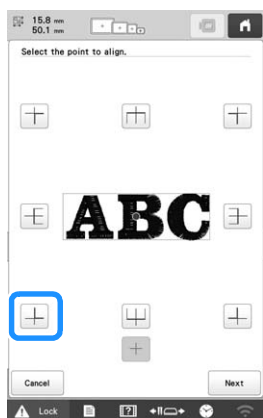

Memo

- Even if the embroidery crosshair positioning laser function is set to [OFF], the embroidery crosshair positioning laser appears so that the pattern can be aligned. When pattern alignment is completed, the embroidery crosshair positioning laser goes off.
- In order for the embroidery crosshair positioning laser to be easily seen, the brightness of the embroidery light will be slightly decreased if it was set at a high setting.

- 8 Touch **Next**.

- 9 Select the direction (from the reference point) to be used as a reference for aligning the pattern.

For this example, select the arrow pointing to the right as the reference direction.

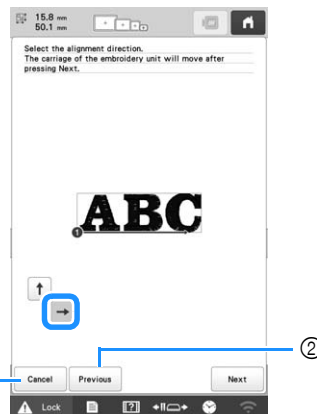

- ① Cancel the pattern alignment settings.
- ② Return to the previous screen.

- 10 Touch **Next**.

- 11 Touch the positioning keys to move the embroidery frame until the embroidery crosshair positioning laser and the center of the mark are aligned.

To change the speed that the frame moves, use the frame movement speed keys. If it is difficult to make a precision alignment, touch a frame movement speed key for a slower speed.

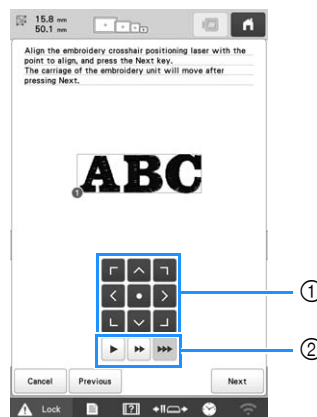

- ① Positioning keys
- ② Frame movement speed keys

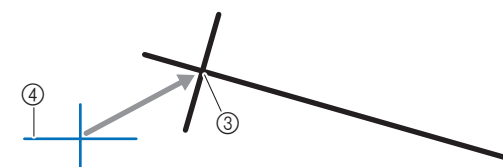

- ③ Center of mark
- ④ Embroidery crosshair positioning laser

12 Touch **Next** .

13 Touch the positioning keys to move the embroidery frame until the embroidery crosshair positioning laser is aligned with the mark in the reference direction.

To change the speed that the frame moves, use the frame movement speed keys. If it is difficult to make a precision alignment, touch a frame movement speed key for a slower speed.

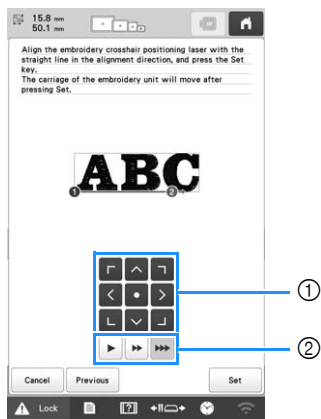

- ① Positioning keys
- ② Frame movement speed keys

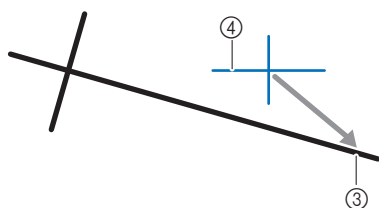

- ③ Reference direction of mark
- ④ Embroidery crosshair positioning laser

Note

- Do not set the position of the embroidery crosshair positioning laser too close to the center of the mark. If it is too close, a message will appear, prompting you to reposition it.
- For best accuracy, set the position of the embroidery crosshair positioning laser on the reference direction of mark (③) as far away from the center of the mark as possible.

14 Touch **Set** .
→ The pattern is repositioned.

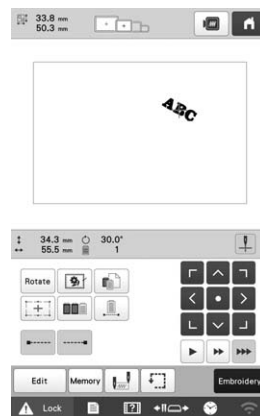

15 Touch **Embroidery** .

16 Touch **Lock** , and then press the "Start/Stop" button to start embroidering.

Another example

By specifying an alignment point and direction, embroidery patterns can be positioned and aligned for various purposes.

In this example, a pattern is aligned at the left center of the towel.

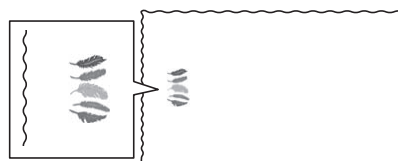

1 Use a chalk pencil to mark the desired embroidering position.

The line drawn for the reference direction should be longer.

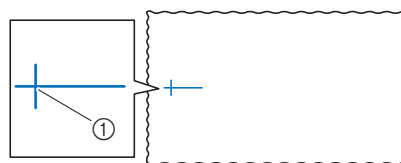

- ① Chalk pencil mark

2 Hoop the fabric in the embroidery frame.

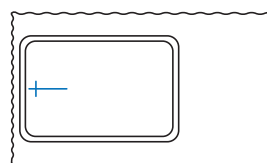

3 Select the pattern.

4 Touch **Edit End** to display the embroidering settings screen.

5 Touch  in the embroidering settings screen.



① Switch on/off the embroidery crosshair positioning laser.

6 If a message appears, indicating that the move and rotate settings will return to the original ones, touch **OK**.

7 From the reference points shown in the screen, select the point to be used for aligning the pattern.

For this example, select the point in the lower-center of the pattern.

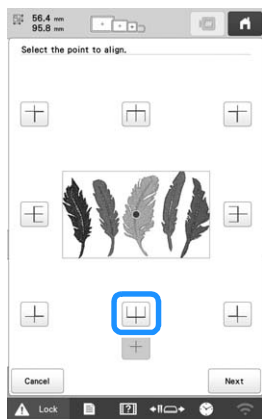

8 Touch **Next**.

9 Select the direction (from the reference point) to be used as a reference for aligning the pattern.

For this example, select the arrow pointing upward as the reference direction.

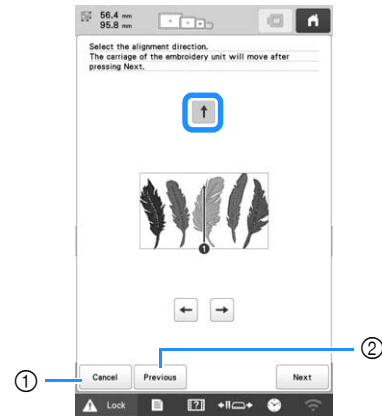

- ① Cancel the pattern alignment settings.
- ② Return to the previous screen.

10 Touch **Next**.

11 Touch the positioning keys to move the embroidery frame until the embroidery crosshair positioning laser and the center of the mark are aligned.

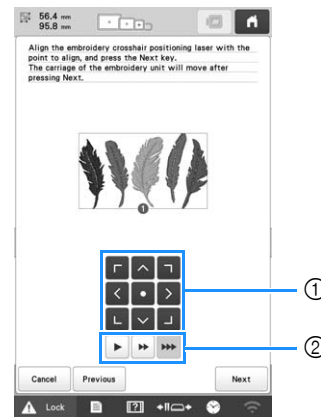

- ① Positioning keys
- ② Frame movement speed keys

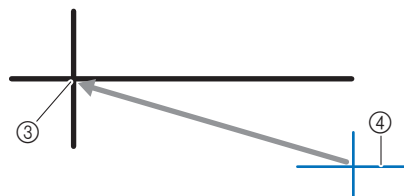

- ③ Center of mark
- ④ Embroidery crosshair positioning laser

12 Touch **Next**.

13 Touch the positioning keys to move the embroidery frame until the embroidery crosshair positioning laser is aligned with the mark in the reference direction.

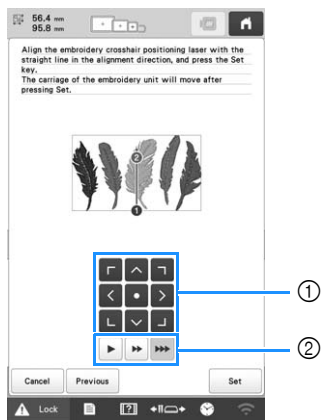

- ① Positioning keys
- ② Frame movement speed keys

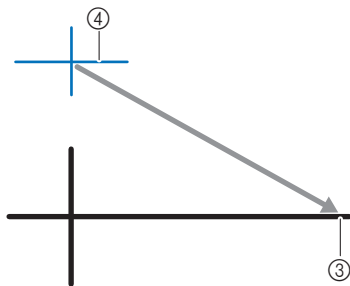

- ③ Reference direction of mark
- ④ Embroidery crosshair positioning laser

14 Touch **Set**.

→ The pattern is repositioned.

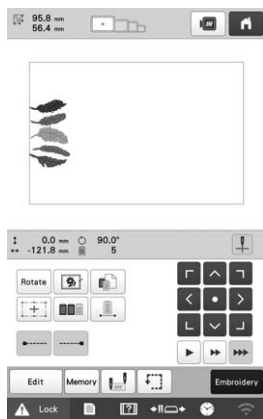

15 Touch **Embroidery**.

16 Touch **Lock**, and then press the “Start/Stop” button to start embroidering.

MAKING EMBROIDERY ADJUSTMENTS

Adjusting the tension of the bobbin thread

Note

- Be sure to check the tension of the bobbin thread each time that the bobbin is changed. Depending on the bobbin thread type and whether a prewound bobbin is used, the tension of the bobbin thread may differ. For example, when replacing an empty prewound bobbin with one of the same type, be sure to check the tension of the bobbin thread and adjust the tension if necessary.
- Be sure to adjust the tension of the bobbin thread before adjusting the tension of the upper thread.

1 Tie the included weight to the end of the thread extending from the bobbin case.

Prewound bobbins

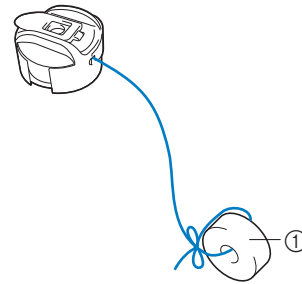

- ① Weight (L)

Note

- Different weights are used to adjust prewound bobbins and metal bobbins.

Metal bobbins:

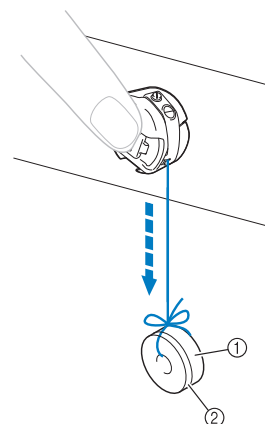

- ① Weight (L)
- ② Weight (S) (included with the optional bobbin winder)

- 2 As shown in the illustration, hold the bobbin case against a smooth vertical surface.

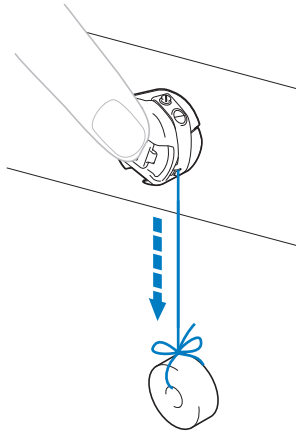

- If the thread with the weight attached is slowly pulled out, the thread tension is correct.

- 3 Use the included standard screwdriver to turn the tension-adjusting screw and adjust the thread tension.

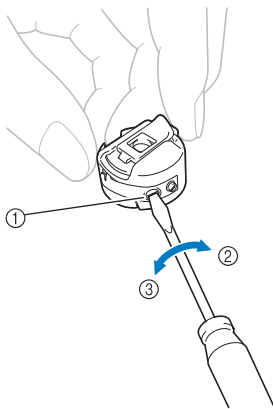

- ① Tension-adjusting screw
- ② Tighter
- ③ Looser

- 4 After making the adjustments, try embroidering with all needle bars to check the thread tension.

Memo

- In the built-in embroidery patterns, one pattern is used for checking the thread tension. By embroidering this pattern, the thread tension can easily be checked. From the wrong side of the fabric, the bobbin thread should be adjusted to be about one third of the stitch width.

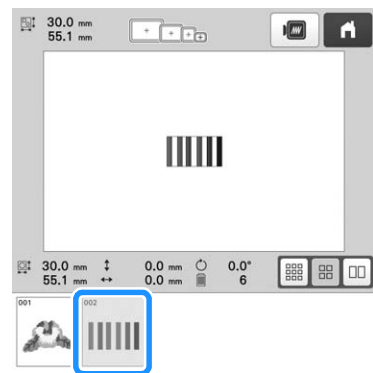
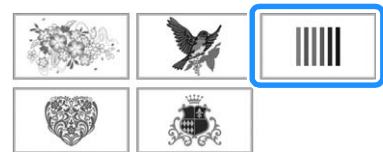
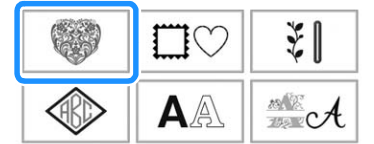

Adjusting the tension of the upper thread

When embroidering, the thread tension should be set so that the upper thread can be seen slightly on the wrong side of the fabric.

Note

- Always embroider a test sample prior to the final project. Adjust the thread tension if necessary.
- The thread tension knobs have a very wide range for adjusting the thread tension.

1 Turn the thread tension knobs.

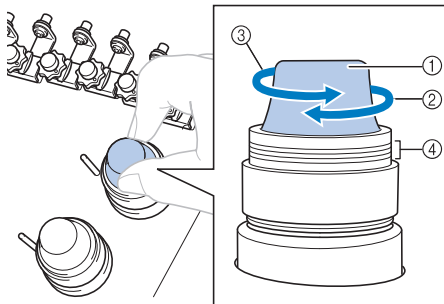

- ① Thread tension knobs
- ② Tighter
- ③ Looser
- ④ Mark

→ If the thread tension is not still correctly adjusted, turn the upper thread guide pretension knob.

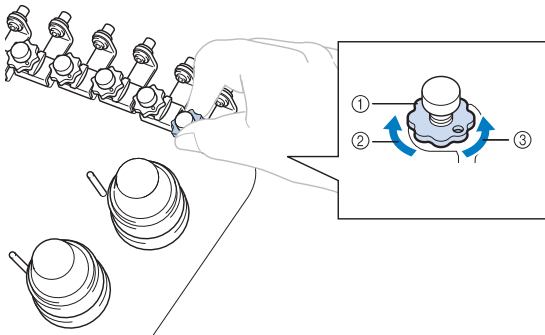

- ① Upper thread guide pretension knob
- ② Tighter
- ③ Looser

Correct Thread Tension

The pattern can be seen from the wrong side of the fabric. If the thread tension is not set correctly, the pattern will not finish well. The fabric may pucker or the thread may break.

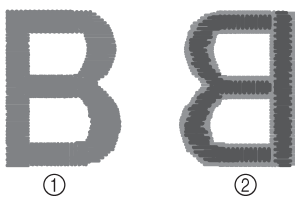

- ① Right side
- ② Wrong side

- Light gray color represents upper thread.
- Dark gray color represents bobbin thread.

Follow the operations described below to adjust thread tension according to the situation.

Note

- If you decrease the thread tension further than the red line, the tension knob may be disassembled. This is not a sign of a malfunction. Increase the thread tension slightly, and begin embroidering again.
- If necessary, refer to page 140 for reassembling the tension unit.

Upper thread is too tight

The tension of the upper thread is too tight, resulting in the bobbin thread being visible from the right side of the fabric.

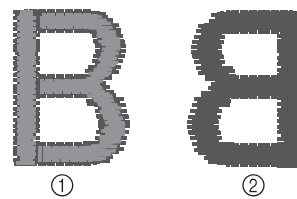

- ① Right side
- ② Wrong side

- Light gray color represents upper thread.
- Dark gray color represents bobbin thread.

Turn the knob in the direction of the arrow to decrease the tension of the upper thread.

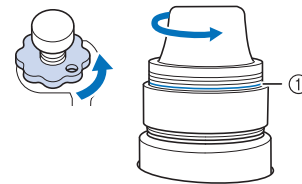

- ① Red line

If the red line is visible, the thread tension cannot be decreased any further. Increase the tension of the bobbin thread. (page 102)

Memo

- If you decrease the thread tension further than the red line, the tension knob may be disassembled.
- If necessary, refer to page 140 for reassembling the tension unit.

Upper thread is too loose

The tension of the upper thread is too loose, resulting in a loose upper thread, loose thread locks or loops appearing on the right side of the fabric.

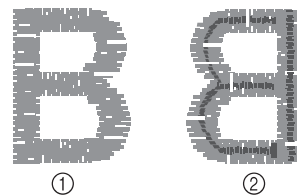

- ① Right side
- ② Wrong side

- Light gray color represents upper thread.
- Dark gray color represents bobbin thread.

Turn the knob in the direction of the arrow to increase the tension of the upper thread.

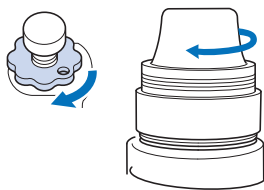

Setting the machine to stop at color changes

The machine can be stopped at any time; however, if the machine is stopped while it is embroidering, it is better to go back a few stitches before continuing embroidering to overlap the stitching. If the machine stops at a color change, it is not necessary to go back through the stitching before continuing embroidering.

Stopping the machine at the next color change

The machine can be set to stop before embroidering the next color.

- 1 While embroidering the color before the point where you wish to stop the machine, touch so that it changes to .



- 2 After finishing embroidering the area for the current color, the next needle bar moves into position and the machine stops before embroidering the next color.

- If the machine is temporarily turned off, you will be asked if you wish to continue embroidering or select a new pattern when the machine is turned on again.

Touch to continue embroidering. (page 92)

Specifying pause locations before embroidering

Pause locations can be specified in the pause setting screen, displayed by touching .

- 1 Touch in the embroidering settings screen.

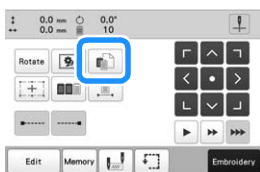

→ The pause setting screen appears.

- 2 From the thread color sequence display, select the thread color where you wish to stop the machine before continuing to embroider.

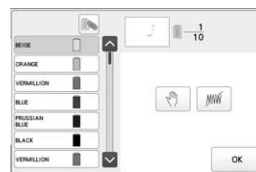

→ The selected thread color is highlighted in blue.

- If the same thread color is used more than once, they can be combined. After selecting a thread color, touch . The key changes to , and all thread colors in the thread color sequence display that are the same as the one that was selected are highlighted in blue.

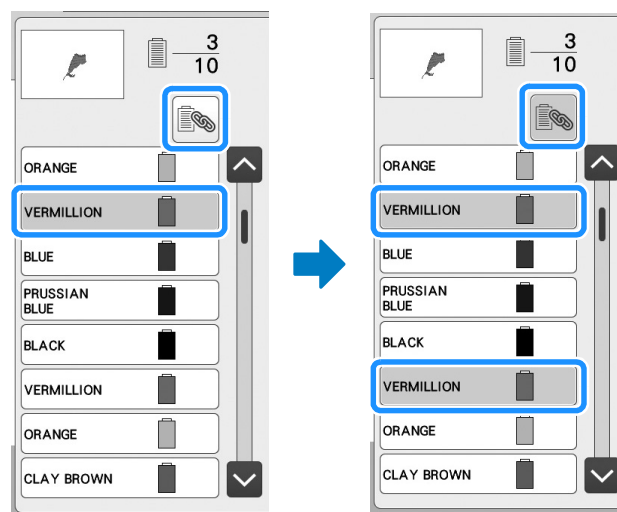

- 3 Touch .

→ The mark appears to indicate where the machine will stop.

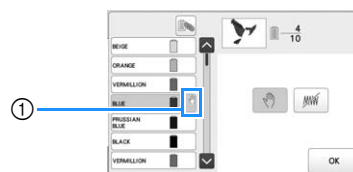

- ① mark

- To cancel the setting, touch again.

- 4 Repeat steps 2 and 3 for each pause that you wish to specify.

- Any number of pauses can be specified.

3

5 After specifying the desired settings, touch .

- If the machine is temporarily turned off when it is stopped at the specified location after embroidering, you will be asked if you wish to continue embroidering or select a new pattern when the machine is turned on again.

Touch  to continue embroidering. (page 92)

 **Memo**

- If the machine is temporarily turned off, the settings to stop the machine at color changes specified before the machine was turned off are not canceled. However, the settings are canceled if a new pattern is selected.
- If a pattern with the settings to stop the machine at color changes is saved, the settings to stop the machine at color changes are also saved.

Temporary needle bar setting

After embroidering begins, the machine can be stopped at a color change and a different needle bar can be specified for the next color to be embroidered.

By substituting an upper thread color already threaded on a different needle bar, the time for embroidering can be saved. For example, similar color thread can be substituted for temporary use.

1 Touch .

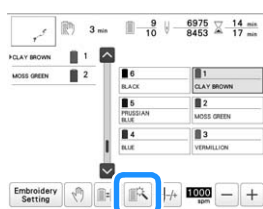

→ The temporary needle bar setting screen appears.

2 Touch the key for the needle bar threaded with the thread that you wish to embroider with.

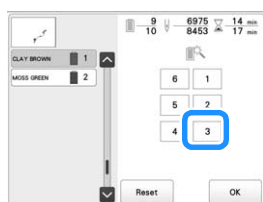

→ The needle bar number changes and  appears to indicate the selected needle bar.

→ To cancel the setting, touch .

3 Touch .

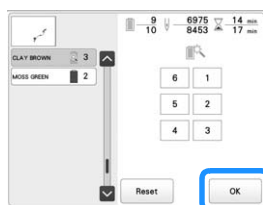

→ The embroidering screen appears again.

 **Memo**

- The thread color (needle bar) cannot be changed in the middle of an area that is being embroidered.

Uninterrupted embroidering (one color)

A selected pattern can be stitched out in one color instead of multiple colors. The machine will hesitate but not stop between color steps, and then continue until the pattern is completed.

1 Touch  in the embroidering settings screen.

- The selected pattern will be embroidered in one color, instead of changing the thread while embroidering.
- Touch  again to return to the pattern's original settings.

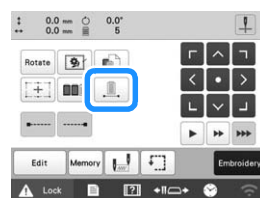

2 Touch  to continue to the embroidering screen.

3 Touch the key for the needle bar threaded with the thread you wish to embroider uninterruptedly.

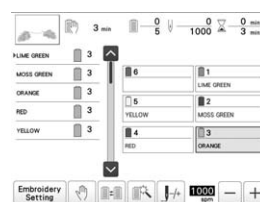

→ The thread color sequence display and pattern for the thread color of the selected needle bar appear.

 **Memo**

- Even if uninterrupted embroidering has been set, the DST thread trimming function can be used. (page 109)

Reserved needle bar and embroidery speed settings

Normally, the machine automatically assigns thread colors to the needle bars; however, a specific thread color can be manually assigned to a certain needle bar. If a needle bar is reserved, that needle bar is removed from the machine's automatic assignments and the specified color remains assigned to it.

By specifically assigning often used thread colors to certain needle bars, the trouble of changing the thread spools can be reduced.

Also, the maximum embroidery speed can be specified to the assigned needle bar. It is useful when you specially set a weak thread such as a metallic thread to the assigned needle bar.

Memo

- This feature is not accessible through the embroidering screen.
- You can assign thread colors up to 5 needle bars in normal mode. When you set [Manual Color Sequence] to [ON] in settings screen, it is available to assign up to 6 needle bars. If you assign all the 6 needle bars in the [Manual Color Sequence] mode, and then you set the machine to the normal mode, the setting of needle bar 6 is canceled automatically. (page 60)

Needle bar settings remain until the setting is canceled.

- 1 Touch .
→ The embroidery settings screen appears.
- 2 Locate [Needle attribute setting] in the Settings pages.
- 3 Touch any of the keys from 1 to 6 for the number of the needle bar that you wish to specify.

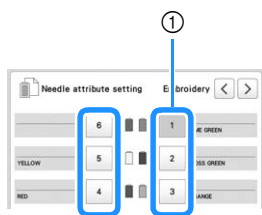

- ① The number of the selected needle bar turns blue.

4 Select the color to be assigned to the needle bar.

Touch , ,  and , or directly touch a color, to select the desired color.

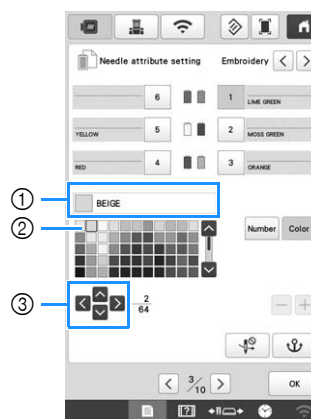

- ① Displays the color that is selected and its name.
- ② The box that appears enlarged is the color that is selected.
- ③ The box moves in the direction of the arrow on the key that is touched.

5 Touch .

→ The selected color of thread and  appear on the selected spool.

6 Touch or to set the maximum embroidery speed for the assigned needle bar.

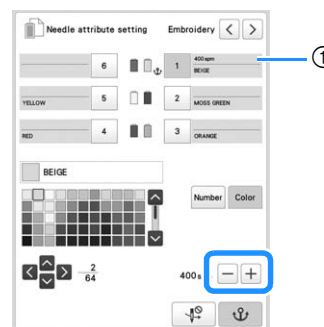

- ① Value of maximum embroidery speed setting

Memo

- Decrease the embroidery speed to 400 spm when using a specialty thread, such as a metallic thread, assigned to a needle bar. ("spm" is the number of stitches embroidered in one minute.)
- The maximum embroidery speed specified here is always in effect for the assigned needle bar, even if you set the faster speed in the embroidering screen. (page 84)

- 7 If necessary, touch  to cancel automatic needle threading.

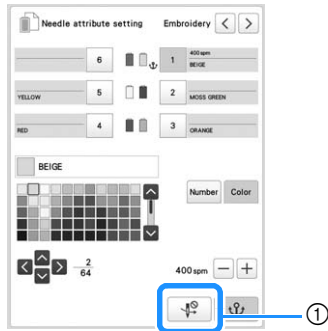

- ① Disable needle threader key

- 8 Touch .

- Specified needle bar is indicated with  and the specified maximum embroidery speed in the embroidering screen.

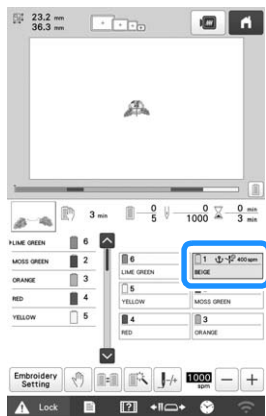



■ Canceling the setting

Note

- The needle bar setting cannot be canceled from the embroidering screen. You must first select  to change these settings.

To change the setting, first cancel it, and then select the new setting.

- 1 Touch any of the keys from  to  for the number of the needle bar whose setting you wish to cancel.

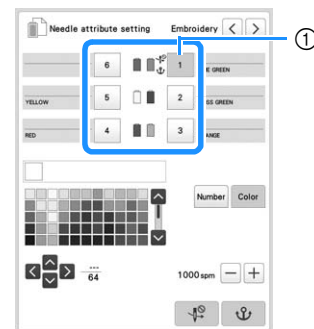

- ① The number of the selected needle bar turns blue.

- 2 Touch .

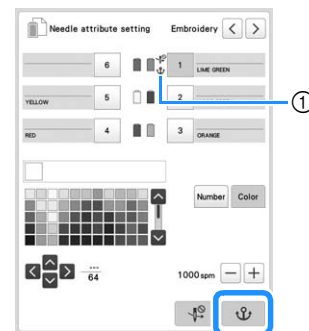

- ①  disappears from the thread spool.
→ The manual needle bar setting is canceled.

- 3 To cancel the cancel needle threading setting, touch  again.

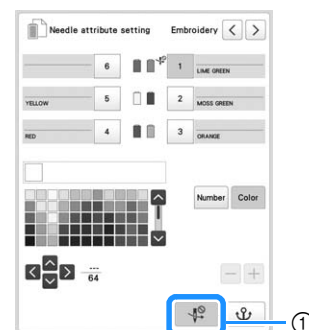

- ① Disable needle threader key

Memo

- Follow the procedure from step [4](#) on page 107, to assign another thread color to a needle bar.

Changing the display guides

The guides in the pattern display area can be specified. The machine automatically detects the type of embroidery frame holder and embroidery frame that are installed and displays them.

Touch .

→ The embroidery settings screen appears.

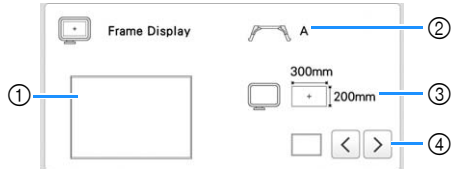







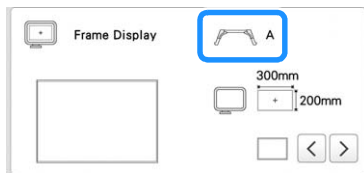

- ① How the guides will appear with the specified settings can be previewed here.
- ② Displays the type of the embroidery frame holder.
- ③ Displays the size of the embroidery frame that is actually installed. (page 68)
- ④ Select the type of the center point marker and the grid lines and whether or not to display them.

■ Type of embroidery frame holder

The machine automatically detects the type of embroidery frame holder that is installed.

If no embroidery frame holder is installed, the setting for “Cap frame/Cylinder frame” is displayed.



Embroidery frame holder A (included)	 A
Embroidery frame holder B (included)	 B
Embroidery frame holder C (Optional)	 C
Embroidery frame holder D (Optional)	 D
Embroidery frame holder E (Optional)	 E
Embroidery frame holder F (Optional)	 F
Cap frame/Cylinder frame (Optional)	
Magnetic sash frame (Optional)	*

* No icon appears since this frame is installed without an embroidery frame holder.

Changing the thread color information

You can display the name of the thread colors, embroidery thread number or the embroidering time.



When the machine is purchased, the thread color number [#123] is selected.

Memo



- Colors on the screen may vary slightly from actual spool colors.
- [Original], imported data retains the brand thread created with the software, is set as a default.

1 Touch .

→ The embroidery settings screen appears.

2 Touch  and  to display the name of the thread colors, the embroidery thread number or the embroidering time.



3 When the thread number [#123] is displayed, touch  and  to select from the embroidery thread brand.



Memo

- The thread brand setting will be applied with the next pattern that is loaded.

Specifying jump stitch trimming / “DST” jump codes for trimming

You can select whether or not jump stitches are trimmed in imported patterns. In addition, when using Tajima embroidery data (.dst), you can select whether or not the thread is trimmed according to a specified number of jump codes.



[ON]: The machine converts the “jump” code to a trim code, based on the number specified in the settings screen.

[OFF]: The machine does not convert the “jump” code to a trim code.

When the machine is purchased, [ON] is selected and the number of jumps is set to [3].

Memo

- On the pattern editing screen, if the jump stitch trim setting key is selected () , the jump stitches will be trimmed even if [Thread Cut Initial Setting] is set to [OFF]. For details, refer to “Trimming jump stitches” on page 49.

- 1 Touch .
→ The embroidery settings screen appears.
- 2 Locate [Thread Cut Initial Setting] in the Setting pages.
- 3 Touch [ON] or [OFF] to select the desired setting.
→ Touch  and  to specify the jump stitch length.
For example, when the value is set to [5 mm], jump stitches will be cut at 5 mm (13/64 inch), but not at 4 mm (5/32 inch).

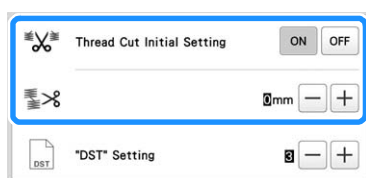

Memo

- The length of jump stitch trimming cannot be specified to Tajima embroidery data (.dst).

■ When using Tajima embroidery data (.dst)

- 4 Touch  and  to select the number of jump codes.

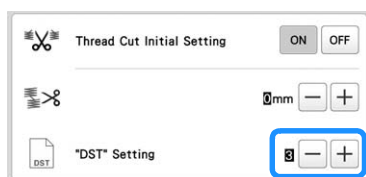



- A value between [1] and [8] can be specified. For example, if [3] is specified, sequential 3 jump codes will be converted to the trim code. But sequential 2 jump codes will not be converted to the trim code, it will be embroidered as the feed (jump) stitch.

Note

- You need to set the jump number same as the number that was used when the particular Tajima data was created.
If the jump number is not matched, either unexpected trim or no trimming at trim expected point will happen.

Deleting short stitches

If embroidery data other than our original patterns are used, the stitch length may be too short, possibly resulting in the thread or the needle breaking. In order to prevent this problem from occurring, the machine can be set to delete stitches with a short stitch length. Stitches with a length less than that specified in this function can be deleted. When the machine is purchased, [0.3] is selected.

- 1 Touch .
→ The embroidery settings screen appears.
- 2 Locate [Short Stitch Delete] in the Settings pages.
- 3 Touch  and  to select the stitch length.

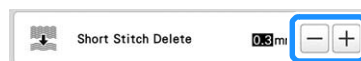

- A value between 0 and 1 millimeters if the units of measurements is set to "mm" (or a value between 0 and 0.04 inch if the units of measurements is set to "inch") can be specified.





Note

- If the setting is changed from the previous setting, the new setting is applied to the subsequent embroidery.

Specifying the remaining length of thread

This setting specifies whether the length of upper thread that remains threaded through the needle after the thread is trimmed (length of thread passed through the eye of the needle) has a standard tail or long tail.

When the machine is purchased, [Standard Tail] is selected.

- 1 Touch .
→ The embroidery settings screen appears.
- 2 Locate  in the Settings pages.
- 3 Touch  and  to select the setting.





- If the machine misses stitches with a standard length of thread after it is trimmed, select [Long Tail].
- When using metallic thread, select [Long Tail].

Changing the embroidery basting distance

The distance from the pattern to the basting stitching can be set to 0.0 mm (0 inch) to 12.0 mm (1/2 inch).

When the machine is purchased, [5.0 mm] is selected. Refer to page 93 when using this setting.

- 1 Touch .
→ The embroidery settings screen appears.
- 2 Locate [Basting Distance] in the Settings pages.
- 3 Use  and  to specify the distance from the pattern to the basting stitching.

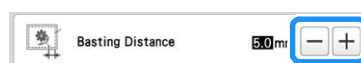

Deselect region setting

The deselect region setting (which specifies that a thread color will not to be embroidered) can be applied to a part of the pattern with a specific color. In this way, you can arrange the embroidery without actually editing the pattern.

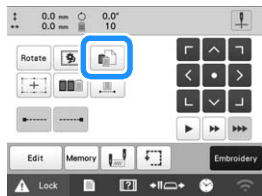

- 1 Touch  in the embroidering settings screen.

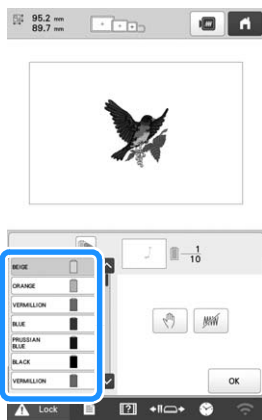

- 2 From the thread color sequence display, select the thread color that will not be embroidered.



→ The selected thread color is highlighted in blue.

- If the same thread color is used more than once, they can be combined. After selecting a thread color, touch . The key changes to , and all thread colors in the thread color sequence display that are the same as the one that was selected are highlighted in blue.

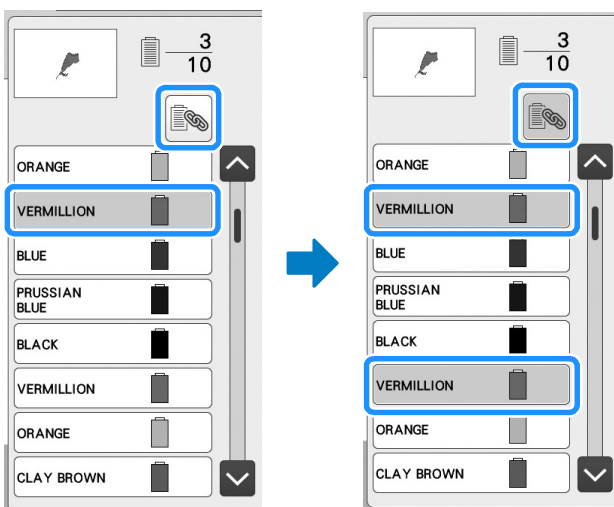

- 3 Touch .

→ The  mark appears to indicate that the selected thread color will not be embroidered.

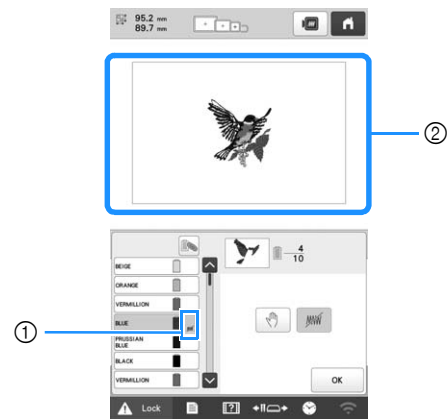



- 1  mark
- 2 The parts of the pattern that will not be embroidered are hidden.

- 4 Repeat steps 2 and 3 for all thread colors that will not be embroidered.

5 After specifying the desired settings, touch .

Memo

- If the deselect region setting is applied to a character pattern, all characters in the pattern will not be embroidered. To deselect region for a single character, use  to separate the character pattern (page 46), or use  (page 55).
- The parts with the deselect region setting applied are not deleted. They can be reverted to being embroidered (refer to “Canceling the deselect region setting” on page 112).
- If the deselect region setting has been applied to all thread colors, a red  appears at the location of the pattern.

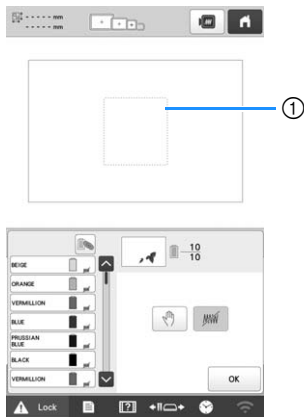



① Red 

- If the machine is temporarily turned off, the settings to deselect region that were specified before the machine was turned off are not canceled. However, the settings are canceled if the same pattern is selected again.
- When a pattern with the deselect region setting applied is saved, the deselect region setting is also saved. However, the pattern cannot be saved if the deselect region setting is applied to all thread colors.

■ Canceling the deselect region setting

1 Select the thread color whose setting is to be canceled, and then touch .

- The key changes to , and the deselect region setting is canceled.
- If thread colors were combined with , the deselect region setting will also be canceled for all thread colors that are the same as the one that was selected.

Starting/ending position settings

1 Touch  in the embroidering settings screen.

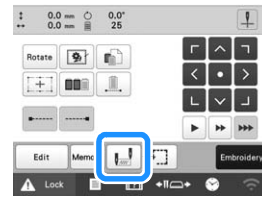

→ The starting/ending position settings screen appears.

2 Select  or .

- When selecting 

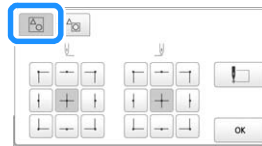

The machine can set the starting point and the ending point separately from the 9 points of the whole pattern. Those are upper-left corner, upper-center, upper-right corner, center-left, center, center-right, lower-left corner, lower-center and lower-right corner. When embroidering of the pattern is finished, the pattern is automatically moved so that the embroidering starting position overlaps the embroidering ending position. This function can be used to repeatedly embroider a pattern along a diagonal. (page 113)

- When selecting 



- ① If there are multiple patterns, select the pattern to be used as the reference for the embroidering starting position.

Set the embroidering starting position for the selected pattern. The position is based on a mask from before the pattern has been rotated. The embroidering ending position is the same as the embroidering starting position.

Memo

- When the machine is purchased,  is selected and both the starting position and the ending position are set to the center of the pattern.
- The starting/ending position settings do not change until the key for a new setting is touched. The settings specified before the machine is turned off remain selected the next time that the machine is turned on. (Basting is added or removed, the setting will return to its default.)

Repeatedly embroidering a pattern along a diagonal

Example



- 1 Touch  in the embroidering settings screen to display the starting/ending position settings screen.

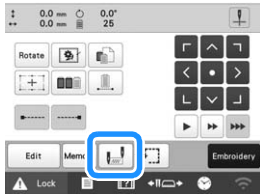



- 2 Select .

- 3 Specify the upper-left corner as the starting position and the lower-right corner as the ending position.

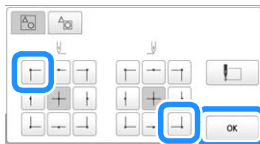

For the starting position, touch  so that it changes to .

For the ending position, touch  so that it changes to .



Touch  to close the starting/ending position settings screen.

- 4 Embroider the first pattern.

Touch  to display the embroidering screen, and then touch  and press the "Start/Stop" button.



- ① Starting position
- ② Ending position

- 5 After embroidering is finished, the machine stops at the lower-right corner of the pattern.

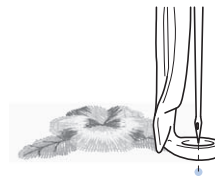

- 6 Touch  and repeat steps 4 and 5 three times.

Note

- If the next embroidery pattern of the series will be stitched outside the embroidery field, the message to inform you that it cannot set the starting/ending position will appear. Rehoop the fabric to continue to repeat the embroidery pattern. Touch  and repeat steps 4 and 5.

Memo

- If the starting position and ending position settings are changed, instead of embroidering the patterns in a fixed direction, various pattern designs are possible.



3

■ Embroidering aligned characters

Follow the procedure described below to embroider aligned characters in a single row when the pattern extends beyond the embroidery frame.

Example: Aligning "DEF" to the characters "ABC"

A B C D E F

Memo

- Ensure that the jump stitch trim setting key appears as  to provide a positioning point for the second group of characters.

1 Select the character patterns for "ABC".

2 Touch  in the embroidering settings screen.

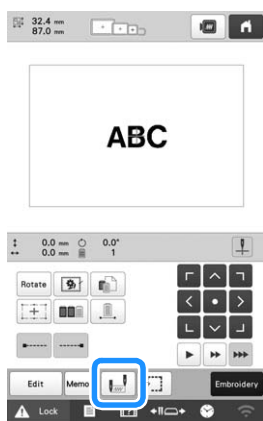

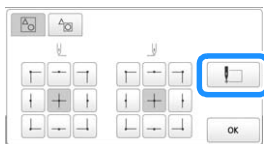

3 Select .

4 Touch .





→ The needle bar is positioned in the lower-left corner of the pattern. The embroidery frame moves so that the needle is positioned correctly.

Note

- To cancel the starting point setting and return the starting point to the center of the pattern, touch .
- Use  to select a different starting point for embroidering.

5 Touch  to return to the embroidering settings screen.

→  changes to  while the starting point is set in the lower-left corner of the pattern.

6 Touch .

7 Touch , and then press the "Start/Stop" button to begin embroidering.

8 After the characters are embroidered, cut the threads, remove the embroidery frame, shift the fabric in the frame, and then attach the embroidery frame again so that the remaining characters ("DEF") can be embroidered.

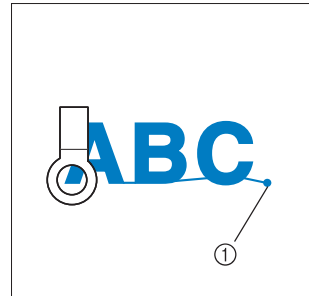

① End of the embroidering



9 As in step **1**, select the character patterns for "DEF".

10 In the embroidering settings screen, touch .

11 Touch .

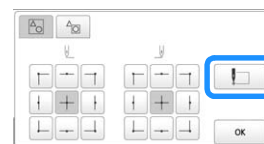

→ The needle bar is positioned in the lower-left corner of the pattern. The embroidery frame moves so that the needle is positioned correctly.

12 Touch .

- 13 Use  to align the needle with the end of embroidering for the previous pattern.

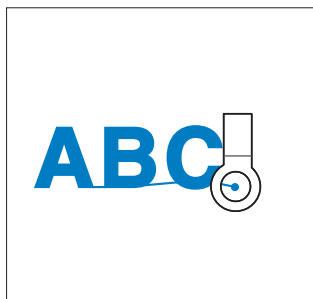

Note

- You can also follow the procedure of “Finding the embroidering position” on page 75, by directly place the needle over the end of the previous pattern.



- 14 Touch .

- 15 Touch , and then press the “Start/Stop” button to begin embroidering the remaining character patterns.



Embroidering a pattern aligned with a mark on the fabric

By specifying the beginning of stitching and the end of stitching, the exact position of the pattern can be checked.

- 1 Touch  in the embroidering settings screen.
- 2 Select .
- 3 Set the beginning of stitching in the lower-left corner.

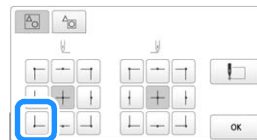

→ The frame moves so that the needle drop point aligns with the beginning of stitching.

- 4 With a fabric marker, mark this point on the fabric.

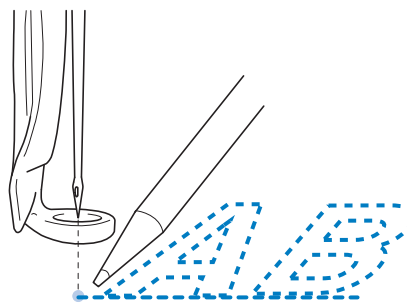

Memo

- If [Embroidery Crosshair Positioning Laser] is set to [ON], the embroidery crosshair positioning laser will be displayed to indicate the needle drop point.

- 5 Set the beginning of stitching in the lower-right corner.

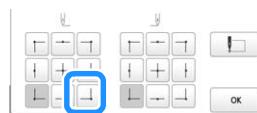

→ The frame moves so that the needle drop point aligns with the beginning of stitching.

- 6 With a fabric marker, mark this point on the fabric.

- 7 Remove the embroidery frame from the machine, and then connect these two points to check the embroidering position.



- If the baseline is misaligned or intersects another line, reframe the fabric in the embroidery frame or adjust the position of the pattern.

USING THE MEMORY FUNCTION

Saving embroidery patterns

Note

- Do not turn the main power to OFF while the [Saving...] screen is displayed. You will lose the pattern you are saving.
- Embroidery patterns cannot be transferred via wireless transmission if the computer and machine are connected to different networks. Be sure to connect to the same network.
- For details on supported computers, refer to "SPECIFICATIONS" on page 156.

- 1 Touch **Memory** when the pattern you want to save is in the embroidering settings screen.

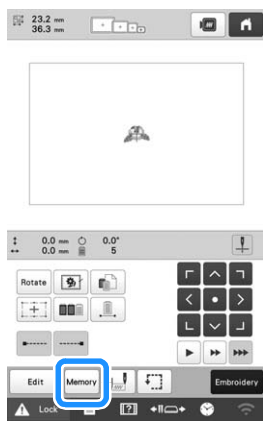

- 2 Touch the desired destination to start saving.

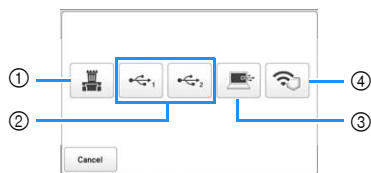

- 1 Save to the machine's memory.
- 2 Save to the USB media. The pattern is saved in a folder labeled [bPocket]. When saving the embroidery pattern in a USB media, insert the USB media into the USB port on the machine.

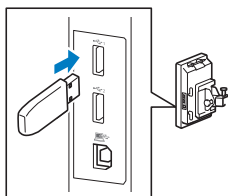

- 3 Save to the computer. When saving the embroidery pattern to a computer, use the included USB cable to connect the machine to the computer. The machine will be recognized as a temporary, removable disk on the computer.
 - The file will be saved to the removable disk. To save the file to a more permanent folder in the computer,

open File Explorer, select the removable disk, then copy the PHX file to the destination folder.

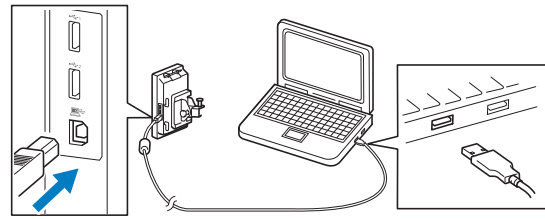

- 4 Save the pattern to the computer via the wireless network connection. For detailed procedures, refer to PE-DESIGN manual (version 11 or later).

Retrieving embroidery patterns

- 1 Touch the desired destination, and then select the desired embroidery pattern.

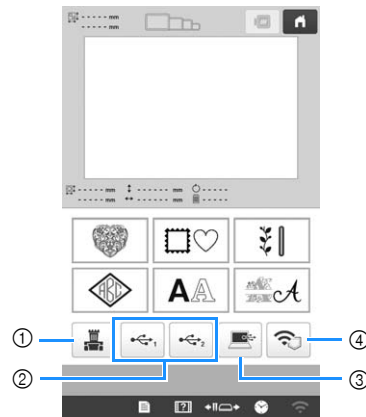

- 1 Retrieve from the machine's memory.
- 2 Retrieve from a USB media. When retrieving the patterns from a USB media, insert the USB media into the USB port on the machine.
- 3 Retrieve from a computer. When retrieving the patterns from a computer, use the included USB cable to connect the computer and the machine. Plug the USB cable connector into the corresponding USB ports for the computer and for the machine. Copy the embroidery pattern file to the removable disk that has been assigned to the embroidery machine.
- 4 Retrieve the pattern via the wireless network connection. For detailed procedures, refer to the manual of PE-DESIGN (version 11 or later) or Design Database Transfer.

Memo

- If the embroidery pattern to be retrieved is in a folder of the USB media, touch the key for that folder. Touch **Back** to return to the previous screen.

- 2 Touch **Set**.



- * To save embroidery patterns to another memory, touch **Memory**, and then select the desired destination.
- * Touch **Delete** to delete the embroidery pattern.

SENDING EMBROIDERY PATTERNS FROM A COMPUTER TO THE MACHINE (LINK FUNCTION)

This machine is compatible with the Link function. This function allows embroidery patterns edited in embroidery software with the Link function, such as PE-DESIGN NEXT or later, to be transferred from a computer to multiple machines. As many as 100 embroidery patterns can be transferred to a machine, and the embroidering status of the patterns being transferred can be viewed from the computer monitor.

Use the included USB cable or the wireless LAN function to connect the machine to a computer. To transfer patterns via the wireless network connection, use PE-DESIGN version 11.2 or later.

Operations available with the Link function

■ Send multiple embroidery patterns to connected machines

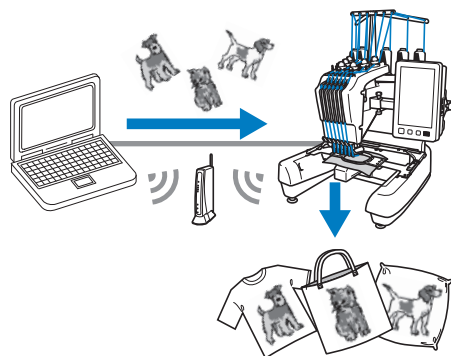

■ Check the embroidering status of the machine (this model) from the computer

(Example of multiple machines connected by the USB cable)

- A maximum of four machines can be connected.

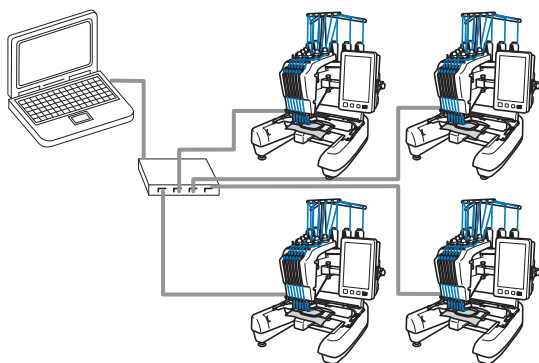

Memo

- When connecting multiple machines to the computer, use a commercially available USB hub. Please note that we recommend you use a self-powered USB hub. Do not use USB extension cables or repeater cables. For details on using the USB hub, refer to its operating instructions.

(Example of multiple machines connected by the wireless LAN function)

- A maximum of ten machines can be connected.

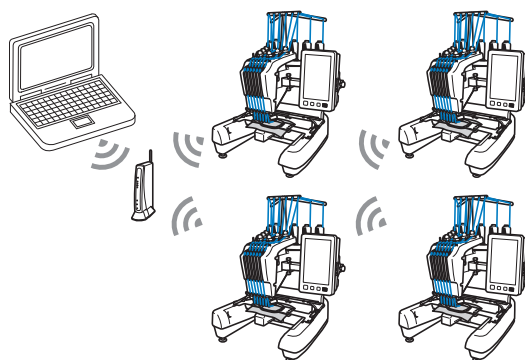

Embroidering using the Link function

First, use the embroidery editing software to create the embroidery pattern to be sent to the machine.

Note

- Embroidery data in the PES format (.pes) and PEN format (.pen) can be embroidered using the Link function.
- The Link function cannot be used with split (large-size) patterns. (page 121)
- Attach to the machine the embroidery frame for the size of the pattern to be sent.

- 1 Touch , then .
→ The general settings screen appears.
- 2 Locate [Link] in the Settings pages.
- 3 Touch and to select [USB cable] or [Wireless LAN].



- 4 Set [Send to] to [Embroidering Screen] or [Embroidering Settings Screen].
• This sets the screen where the machine receives the embroidery pattern from the computer.

- 5 Touch [ON] to enable the Link function.



→ When the following message appears, touch .



Memo

- When the Link function by the USB cable connection is turned on while [Wireless LAN Enable] is set to [ON], the message to set [Wireless LAN Enable] to [OFF] appears.
- When the Link function by the wireless LAN connection is turned on while [Wireless LAN Enable] is set to [OFF], the message to set [Wireless LAN Enable] to [ON] appears.

6 Turn off the machine.

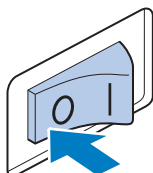

Note

- When you turn off the machine, wait for about 5 seconds before turning on the machine again.

7 Connect the machine to the computer.

- USB cable connection

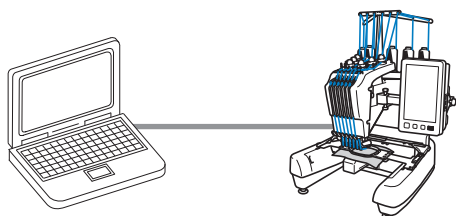

When connecting the machine to the computer, use the included USB cable.

- Wireless LAN connection



For details on the wireless LAN connection, refer to page 30.

8 Turn on the machine.

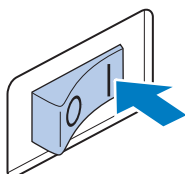

9 Using embroidery editing software with the Link function, such as PE-DESIGN NEXT or later from a computer, send the pattern to the machine in the Link mode.

10 When the following message appears, touch .

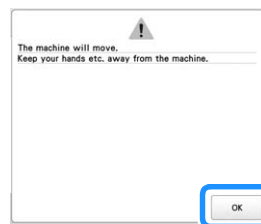

- USB cable connection
- Wireless LAN connection

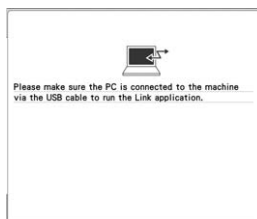

→ A message appears in the machine's LCD while the machine is connecting to computer.

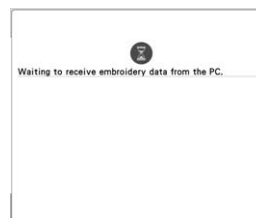

Note

- For details on using the embroidery editing software, refer to the Instruction Manual included with it.

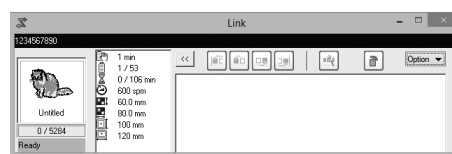

* This Link dialog box is found in PE-DESIGN NEXT software.

- If the following error message appears, the type of embroidery frame installed on the machine is not compatible with the size of the pattern. Replace the embroidery frame with one compatible with the size of the pattern.



11 The embroidery pattern is sent to the machine.

- If [Send to] is set to [Embroidering Screen], the embroidery pattern sent to the machine will appear in the embroidering screen. Refer to “Embroidering a pattern received in the embroidering screen” on page 119, and continue the operation with the machine.
- If [Send to] is set to [Embroidering Settings Screen], the embroidery pattern sent to the machine will appear in the embroidering settings screen. Refer to “Embroidering a pattern received in the embroidering settings screen” on page 120, and continue the operation with the machine.

Embroidering a pattern received in the embroidering screen

If [Send to] is set to [Embroidering Screen], the embroidery pattern sent to the machine will appear in the embroidering screen.

1 After the embroidery pattern has been sent to the machine, the embroidering screen appears.

→ The opened embroidery pattern appears in the pattern display area with the icon for the Link function.

- USB cable connection
- Wireless LAN connection

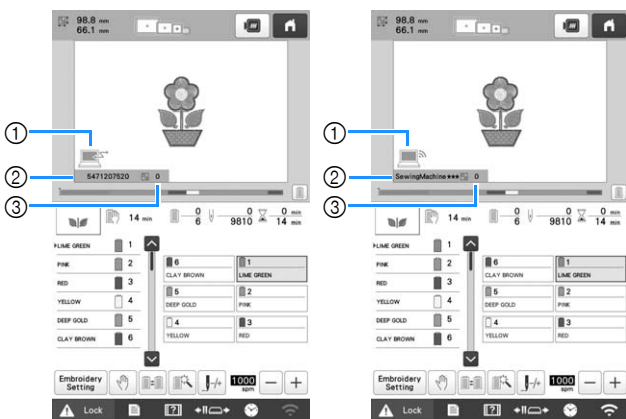

- | | |
|--------------------------------------|--------------------------------------|
| ① Icon for Link function | ① Icon for Link function |
| ② 10-digit machine ID | ② The machine's name |
| ③ Number of the pattern in the queue | ③ Number of the pattern in the queue |

Memo

- While the machine is connected to the computer, the machine's status can be displayed by using a function of the embroidery editing software. If multiple machines are connected at the same time, check the status of the machines using the 10-digit machine ID or machine's name that appears in the machine's screen. The following information can be viewed from the computer.
 - Machine's status
 - Information on the embroidery data being embroidered and received by the machine (time until the next time that the machine stops, number of color changes, embroidering time, maximum embroidery speed, pattern size, size of frame being used on the machine)

2 To change the embroidering settings for the opened embroidery pattern, touch [Embroidery Setting]. If the settings will not be changed, continue with step 4.

- Touch [OK] when the following message appears.
- Touch [Cancel] to return to the embroidering screen.



→ The embroidering settings screen appears.

3 After the desired settings have been specified, touch [Embroidery] to return to the embroidering screen.

- USB cable connection
- Wireless LAN connection

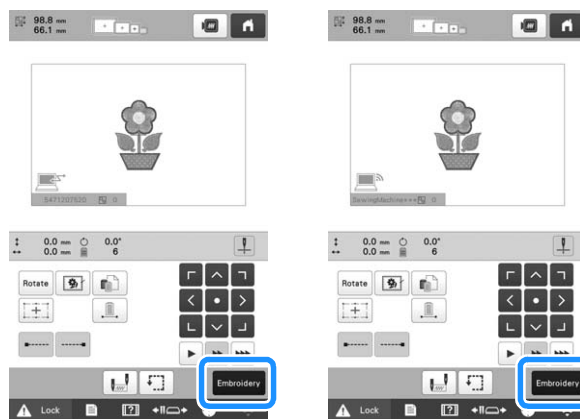

4 Touch [Lock], and then press the “Start/Stop” button to start embroidering.

→ When embroidering is finished, the following message appears.



5 To open another pattern sent from the computer, touch [OK], and then repeat the procedure starting from step 1 to continue embroidering.

To stop embroidering or to embroider the same pattern again, touch [Cancel].



Memo

- The embroidering screen settings specified in step 3 are saved even if **OK** was touched to continue embroidering after embroidering is finished.
- If the machine is turned off while it is embroidering, the resume operation can be used the next time it is turned on.

Embroidering a pattern received in the embroidering settings screen

If [Send to] is set to [Embroidering Settings Screen], the embroidery pattern sent to the machine will appear in the embroidering settings screen.

1 After the embroidery pattern has been sent to the machine, the embroidering settings screen appears.

→ The opened embroidery pattern appears in the pattern display area with the icon for the Link function.

- USB cable connection
- Wireless LAN connection

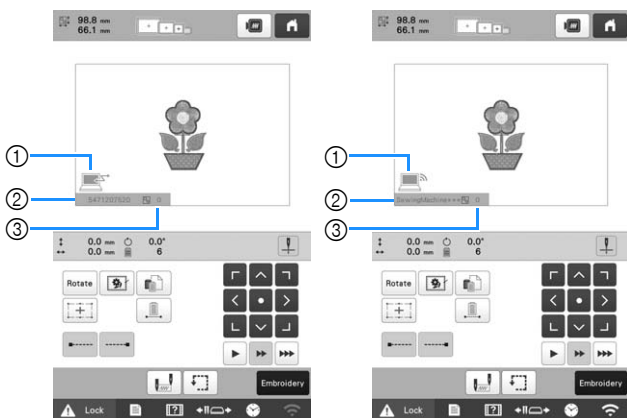

- ① Icon for Link function
- ② 10-digit machine ID
- ③ Number of the pattern in the queue

- ① Icon for Link function
- ② The machine's name
- ③ Number of the pattern in the queue

Memo

- While the machine is connected to the computer, the machine's status can be displayed by using a function of the embroidery editing software. If multiple machines are connected at the same time, check the status of the machines using the 10-digit machine ID or machine's name that appears in the machine's screen. The following information can be viewed from the computer.
 - Machine's status
 - Information on the embroidery data being embroidered and received by the machine (time until the next time that the machine stops, number of color changes, embroidering time, maximum embroidery speed, pattern size, size of frame being used on the machine)

2 After the desired settings have been specified, touch

Embroidery to continue to the embroidering screen.

3 Touch **Lock**, and then press the "Start/Stop" button to start embroidering.

→ When embroidering is finished, the following message appears.



4 To open another pattern sent from the computer, touch **OK**, and then repeat the procedure starting from step 1 to continue embroidering.

To stop embroidering or to embroider the same pattern again, touch **Cancel**.

Memo

- If the machine is turned off while it is embroidering, the resume operation can be used the next time it is turned on.
- The embroidering screen settings specified in step 1 are saved even if **OK** was touched to continue embroidering after embroidering is finished.

Disabling the Link function

1 Touch **Settings**, then **Link**.

→ The general settings screen appears.

2 Locate [Link] in the Settings pages.

3 Touch [OFF] to disable the Link function.



→ When the message to finish the Link mode appears, touch **OK**.

4 Turn off the machine.

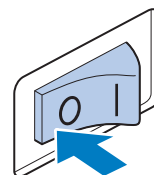

Note

- When you turn off the machine, wait for about 5 seconds before turning on the machine again.

EMBROIDERY APPLICATIONS

Embroidering split (large-size) patterns

Split (large-size) patterns created with PE-DESIGN version 7 or later, or PE-DESIGN NEXT can be embroidered. With large-size patterns, embroidery designs larger than the embroidery hoop are divided into multiple sections, which combine to create a single pattern after each section is embroidered.

For details on creating large-size embroidery patterns and for more detailed embroidering instructions, refer to the manual included with PE-DESIGN version 7 or later, or PE-DESIGN NEXT.

The following procedure describes how to read the large-size embroidery pattern shown below from USB media and embroider it.

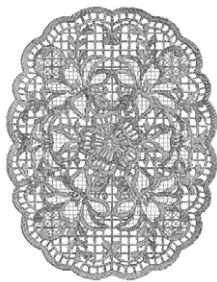

1 Connect to the machine the media containing the created large-size embroidery pattern, and then select the large-size embroidery pattern to be embroidered.

* For details on retrieving patterns, refer to page 116.

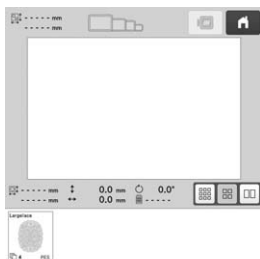



→ A screen appears so that a section of the large-size embroidery pattern can be selected.

2 Select section  to be embroidered, then touch

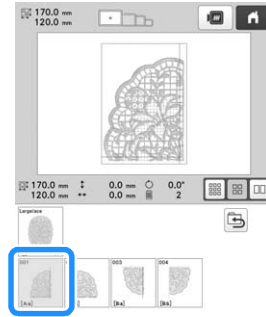

- Select the sections in alphabetical order.



3 If necessary, edit the pattern. Then, touch .

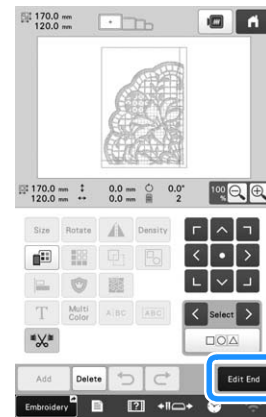

- For details, refer to "EDITING THE EMBROIDERY PATTERN" on page 46.

4 Confirm the pattern size, and then select the appropriate fabric and the embroidery frame.

- Be sure to select fabric of the size of combined pattern.

5 Hoop the appropriate part of the fabric. In this case, hoop upper-left part of the fabric.

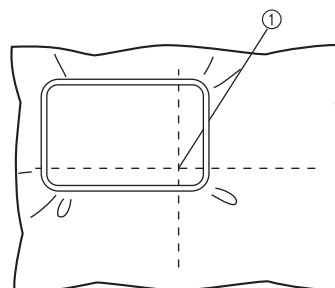

① Center of fabric

3

6 Touch **Embroidery**.

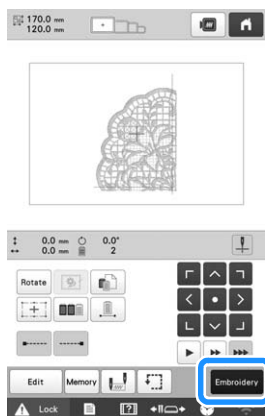

Memo

- The pattern can be rotated to either the left or right when **Rotate** is touched.

7 Touch **Lock**, and then press the “Start/Stop” button to embroider the section.

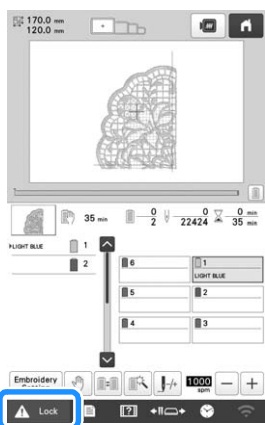

Note

- The last step of the stitching of the section will be an alignment stitching. Use this stitching for placement of adjacent section.

8 When embroidering is finished, the message to confirm to embroider the next section appears. Touch **OK**.

→ A screen appears so that a section of the large-size embroidery pattern can be selected.

9 Touch  to select the next section of the pattern, and then touch **Set**.

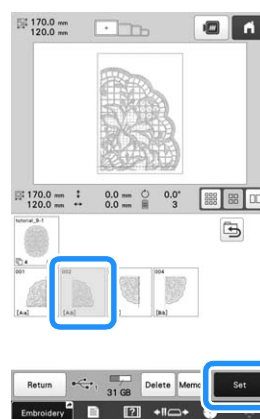

10 Touch **Edit End**, and then **Embroidery**.

11 Hoop the fabric for the next section aligning on the alignment stitching. In this case, align the left side of the hoop on the right side of the section embroidered in step **6**.

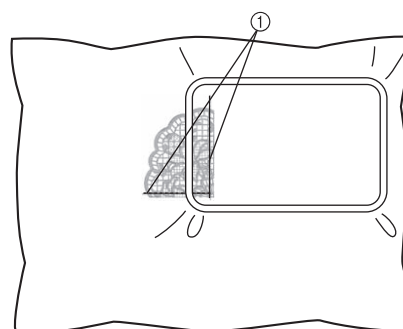

① Alignment stitching

Note

- For details on aligning and stitching split, large-size embroidery patterns, refer to the manual included with PE-DESIGN version 7 or later, or PE-DESIGN NEXT.

12 Repeat steps **7** to **10** to embroider and combine the remaining sections of the pattern.

USING THE OPTIONAL BOBBIN WINDER



When winding the bobbin thread onto a metal bobbin, use the optional bobbin winder.

⚠ CAUTION



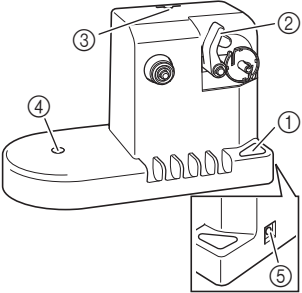

- Be sure to place the bobbin winder on a level, stable surface.
- Be sure to use the bobbins supplied with this bobbin winder.

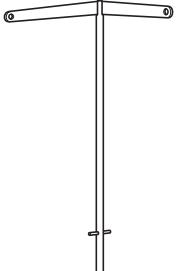
Optional bobbin winder and its accessories

Check that the following bobbin winder and accessories are included. When the part code is "*", contact your authorized Brother dealer.

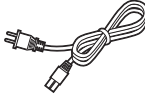
	Part Name
	Part Code
1. 	Bobbin winder
	PRBW1
2. 	Spool pin
	XC5949-051
3. 	Spool cushion
	XA0679-050
4. 	Thread guide
	XC6644-151

- ① Main power switch
- ② Bobbin winder shaft
- ③ Hole for thread guide
- ④ Hole for spool pin
- ⑤ DC input connector

	Part Name
	Part Code
5. 	AC adapter
	*
6. 	Power supply cord
	*
7. 	Metal bobbin × 5
	100376-051
8. 	Spool cap
	130012-057
9. 	Weight (L)
	XC5974-151
10. 	Weight (S)
	XC6631-051

📄 Memo

- The part code of the bobbin winder set may differ depending on the country/area where the machine was purchased.
- Depending on the model you purchased, the bobbin winder may be included with the machine.

Setting up the optional bobbin winder

1 Insert the spool pin and the spool cushion.

Insert the spool pin holder, and then insert the spool pin straight into the hole. Place the spool cushion on the spool pin.

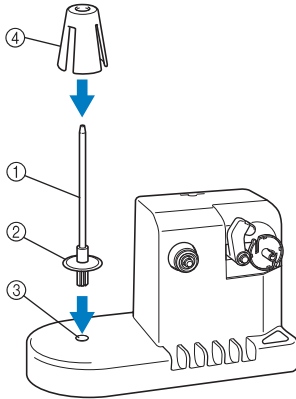

- ① Spool pin
- ② Spool pin holder
- ③ Hole for spool pin
- ④ Spool cushion

2 Insert the thread guide.

Insert the thread guide straight into the hole with the pins on the thread guide aligned with the notches on the sides of the hole.

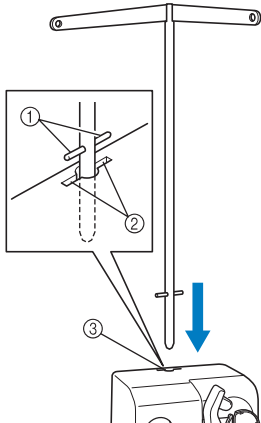

- ① Pins on thread guide
- ② Notches on hole for thread guide
- ③ Hole for thread guide
- Firmly insert the thread guide as far as possible and make sure that it is secure.

Connecting the AC adapter

1 Insert the plug of the power supply cord into the AC adapter.

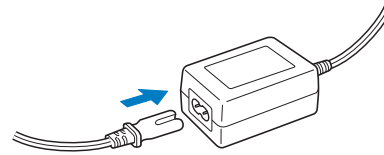

2 Plug the cord on the AC adapter into the DC input connector of the bobbin winder, and then insert the plug of the power supply cord into a household electrical outlet.

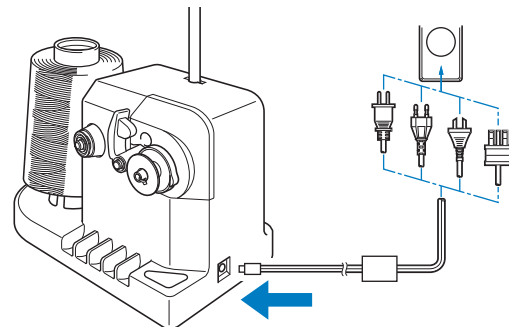

- Be sure to firmly insert the plug on the AC adapter into the DC input connector of the bobbin winder.

⚠ CAUTION

- Be sure to use the included AC adapter and power cord of the bobbin winder.
- Before connecting or disconnecting the AC adapter, be sure that the unit is not operating.
- After using the bobbin winder, disconnect it from the electrical outlet.

Winding the bobbin

Prepare the bobbin and the spool of bobbin thread. Use cotton or spun polyester bobbin thread (from 74 dtex/2 to 100 dtex/2).

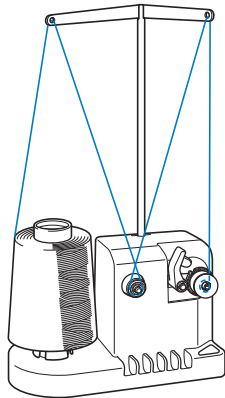

- 1 Align the groove in the bobbin with the spring on the bobbin winder shaft, and set the bobbin on the shaft.

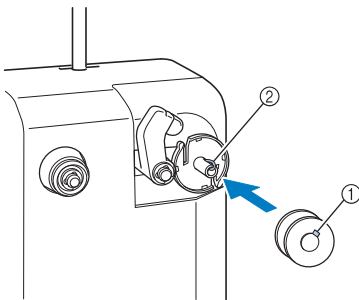

- 1 Groove in the bobbin
- 2 Spring on the shaft

- 2 Set the thread spool on the spool pin.

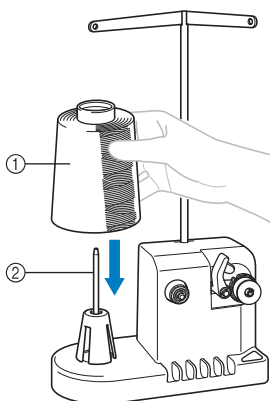

- 1 Thread spool
- 2 Spool pin

Note

- When using a small spool, remove the spool cushion and set the spool directly onto the spool pin. Also use the included spool cap to keep the small spool stable.

- 3 Pass the thread through the hole in the left of the thread guide toward the front of the winder.

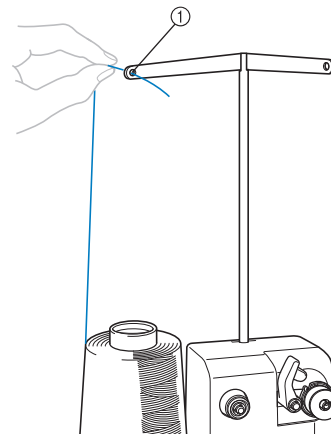

- 1 Hole in the thread guide

- 4 Pass the thread around the tension disc as shown in the illustration. Make sure that the thread is correctly fed into the tension disc.

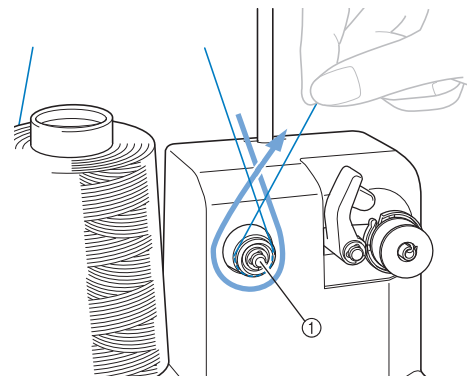

- 1 Tension disc

- 5 Pass the thread through the hole in the right of the thread guide toward the back of the machine.

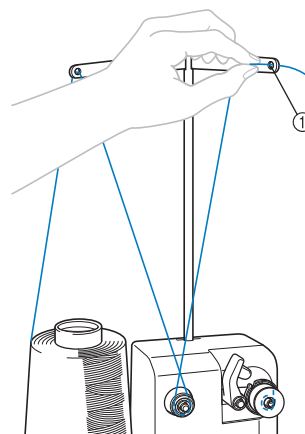

- 1 Hole in the thread guide

- 6** Wind the thread clockwise around the bobbin 4 or 5 times, as shown in the illustration.

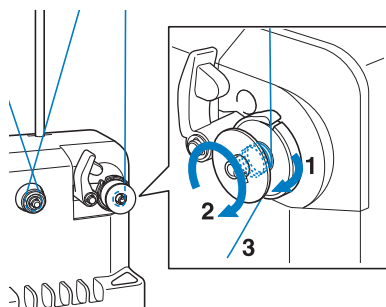

- 7** Pass the end of the thread through the guide slit in the bobbin winder seat, and pull the thread. The cutter will cut the thread.

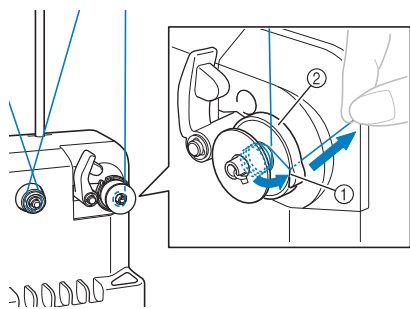

- ① Guide slit
② Bobbin winder seat

Note

- Be sure to follow the procedure described. If the bobbin is wound without the thread being cut with the cutter, when the bobbin thread runs low, the thread may become tangled around the bobbin and cause the needle to break.

- 8** Slide the bobbin holder, until it clicks into place.

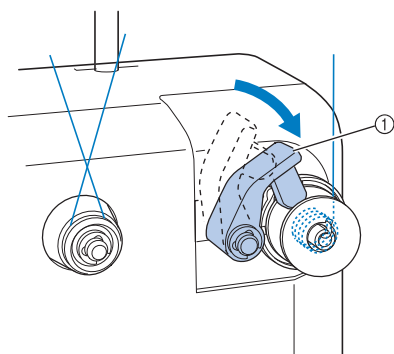

- ① Bobbin holder

- 9** Press the main power switch to start winding the bobbin.

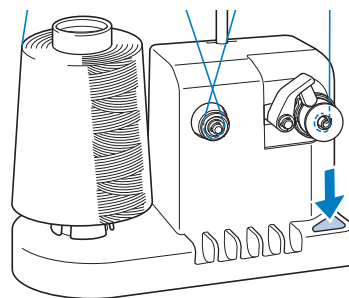

→ Start winding the bobbin.

- 10** The bobbin will stop rotating automatically when it is done winding, and the bobbin holder will return to its original position.

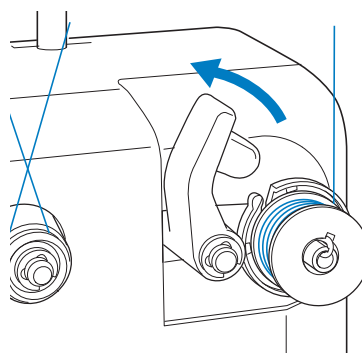

- 11** Remove the bobbin.

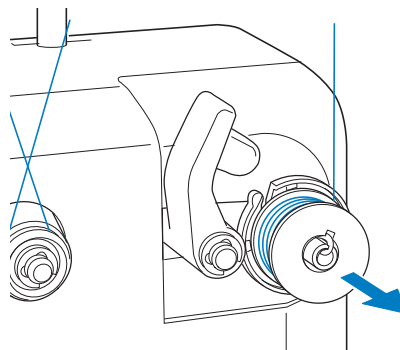

Note

- When removing the bobbin, do not pull on the bobbin winder seat. Doing so could loosen or remove the bobbin winder seat, resulting in damage to the bobbin winder.

- 12 Pull the thread through the guide slit in the bobbin winder seat to cut the thread with the cutter.

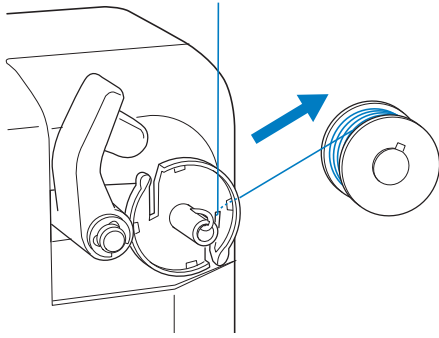

⚠ CAUTION

- Check that the bobbin thread has been wound correctly, otherwise the needle may break or the thread tension will be incorrect.

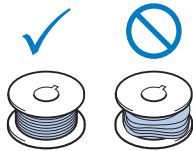

- Be sure to clean the bobbin case each time that the bobbin is changed. For details, refer to "Cleaning the bobbin case" on page 139.
- Be sure to check the tension of the bobbin thread each time that the bobbin is changed. For detailed instructions on how to adjust the bobbin tension, refer to page 102.

■ If bobbin winding is stopped before it is finished

The bobbin winder stops automatically if the thread does not feed, for example, if it becomes tangled on the spool pin. If this occurs, correctly thread the bobbin winder, and then wind the bobbin correctly.



Chapter 4 ADMINISTRATOR MODE

ADMINISTRATOR LOCK

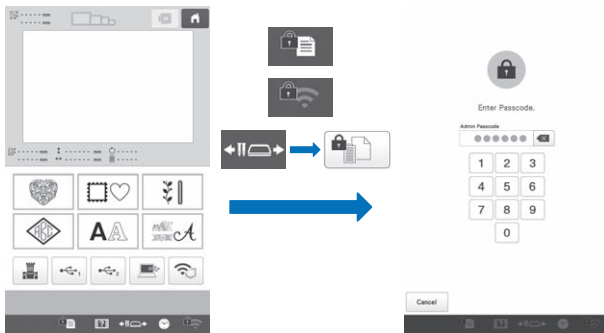
Settings screens can be locked so that only the administrator can change the settings. In order to access the settings screens, the 6-digit passcode specified by the administrator must be entered.



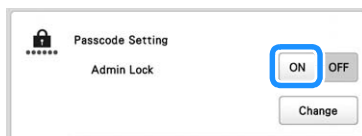

Configuring administrator lock

- 1 Touch , then .
→ The general settings screen appears.
- 2 Locate [Passcode Setting] in the Settings pages.
- 3 Touch [ON] beside [Admin Lock].





- To change the passcode, continue with step 4.
- If the passcode will not be changed, continue with step 8. (The initial passcode is 999999.)

- 4 Touch  beside [Admin Lock].
- 5 Type in the new passcode (6 digits).
- 6 Type it in again for confirmation.
 - If a mistake was made while typing, start over with the first digit.
- 7 Touch .
- 8 Touch .
→ Administrator lock is enabled, and key symbols appear on the settings keys.

Afterwards, each time a settings key is touched, the 6-digit passcode must be entered.



Memo

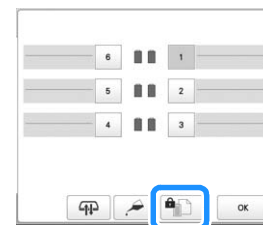

-  is the key in the following screen, which appears after  is touched.



Accessing settings screens when administrator lock is enabled

When administrator lock is enabled, key symbols appear on the settings keys.

A 6-digit passcode must be entered in order to access the settings screen after touching its settings key.

- 1 Touch .
→ The administrator passcode input screen appears.
 - The same happens if  or  is touched.
- 2 Type in the 6-digit passcode.

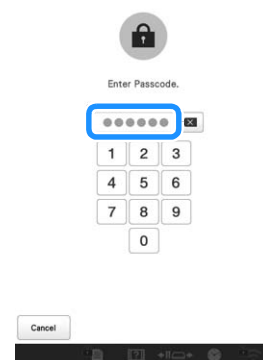

→ If the correct passcode was entered, the settings screen can be accessed.

Memo

- If the wrong passcode is entered 10 times, the passcode will be reset and return to the initial passcode (999999).

Canceling administrator lock

1 Follow the procedure described in “Accessing settings screens when administrator lock is enabled” on page 129 to display the settings screen.

2 Touch .

→ The general settings screen appears.

3 Locate [Passcode Setting] in the Settings pages.

4 Touch [OFF] beside [Admin Lock].

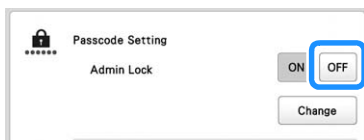

5 Touch .

→ Administrator lock is canceled, and the key symbols are removed from the settings keys.

OPERATOR LOCK

The LCD screen can be locked so that only the designated operator can use it. In order to use the LCD screen, the 4-digit passcode specified by the administrator must be entered.

The LCD screen will be locked in the following situations.

- The lock screen key is touched.
- The LCD screen is touched after the set length of time has passed, causing the screen saver to appear.
- The machine is turned off, then on again.

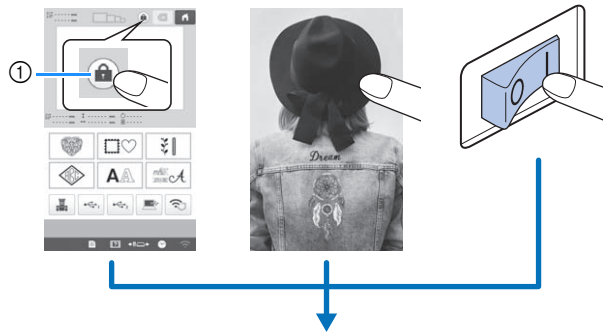

① Lock screen key



Configuring operator lock

1 Touch , then .



→ The general settings screen appears.

2 Locate [Passcode Setting] in the Settings pages.

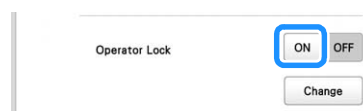
3 Touch [ON] beside [Operator Lock].



- To change the passcode, continue with step 4.
- If the passcode will not be changed, continue with step 8. (The initial passcode is 9999.)

- 4 Touch  beside [Operator Lock].
- 5 Type in the new passcode (4 digits).
- 6 Type it in again for confirmation.
 - If a mistake was made while typing, start over with the first digit.
- 7 Touch  .
- 8 Touch  .
 - Afterwards, each time the LCD screen is locked, the 4-digit passcode must be entered to continue operation.
 - For details on the procedure when the LCD screen is locked, refer to "OPERATOR LOCK" on page 130.

Accessing screens when the LCD screen is locked

When the LCD screen is locked, the passcode input screen will appear.

In order to access screens, the 4-digit passcode specified by the administrator must be entered.

Type the 4-digit passcode in the passcode input screen.





→ If the correct passcode was entered, the screen displayed before the LCD screen was locked appears, and the LCD screen can be used.

Memo

- If the wrong passcode is entered 10 times, the passcode will be reset and return to the initial passcode (9999).

■ Canceling operator lock

- 1 Touch , then  .
 - The general settings screen appears.

- 2 Locate [Passcode Setting] in the Settings pages.

- 3 Touch [OFF] beside [Operator Lock].

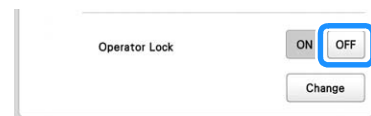

- 4 Touch  .

KEY OPTIMIZATION MODE

You can select the functions (keys) not to be available according to the purpose and conditions of the job, and optimize the key display in the screen to the minimum necessary. By optimizing the key display, errors can be reduced, job efficiency increased, and the machine used more easily. Once specified, the key display optimization settings can be saved and recalled at any time.

Memo

- This function cannot be used when the machine is in Link mode.

Specifying/changing key display optimization

Follow the procedure below to specify key display optimization for the first time or to change the optimization settings specified on the machine.

Memo

- Only one set of optimization settings can be saved on the machine. If the settings are changed, the saved settings will be overwritten with the newest ones.
- Your favorite optimization settings can be saved on USB media and recalled at any time. (Refer to steps 13 through 14.)

1 Touch , then .

→ The general settings screen appears.

2 Locate [Key Optimization Mode] in the Settings pages.

3 Touch .

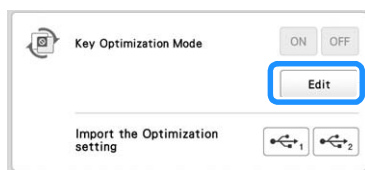

4 Confirm the information in the message that appears, and then touch .

5 In the pattern type selection screen, touch the keys not to be available.

- The keys in the red box can be set to not be available.
→ The selected key changes to gray, and the prohibition symbol appears in the upper-left corner of the key.



① Red box

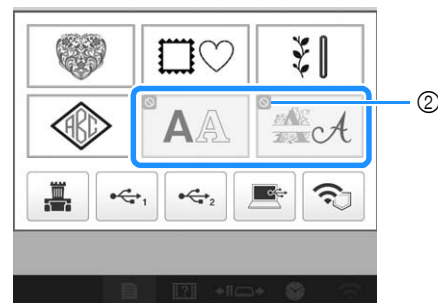

② Symbol indicating key that is not available

Memo

- Touch a gray key to make it available again.

6 Touch  to continue to the pattern editing screen.

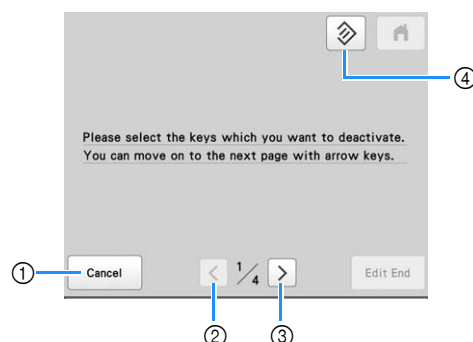

- 1 Cancel the optimization settings.
- 2 Return to the previous screen of settings. (Not available while specifying settings on screen 1/4.)
- 3 Continue to the next screen of settings. (Not available while specifying settings on screen 4/4.)
- 4 Return the keys in this screen to their original settings.

7 In the pattern editing screen, touch the keys not to be available.

→ The selected key changes to gray, and the prohibition symbol appears in the upper-left corner of the key.

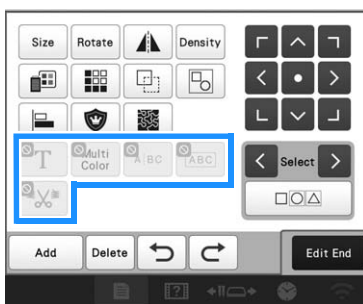
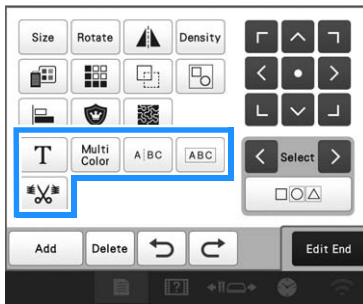

8 Touch **>** to continue to the embroidering settings screen.

* For details on the keys, refer to step **6**.

9 In the embroidering settings screen, touch the keys not to be available.

→ The selected key changes to gray, and the prohibition symbol appears in the upper-left corner of the key.

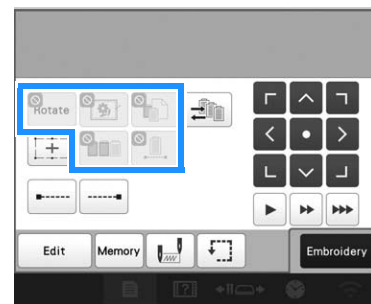
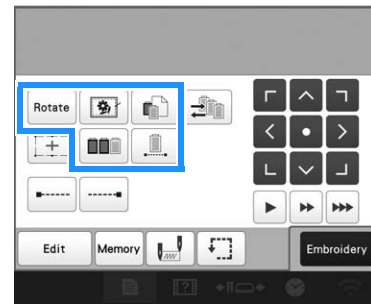

10 Touch **>** to continue to keys used when retrieving embroidery patterns.

* For details on the keys, refer to step **6**.

- 11** Of **Delete** (delete pattern) and **Memory** (save pattern in other storage destination), touch the keys not to be available when retrieving an embroidery pattern.

→ The selected key changes to gray, and the prohibition symbol appears in the upper-left corner of the key.

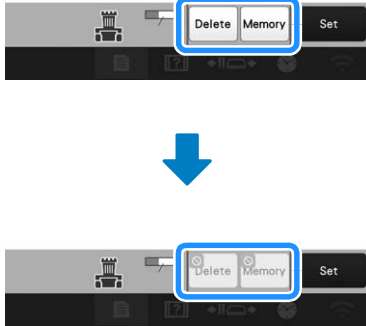

Memo

- The key settings specified here are applied when retrieving patterns in the following situations.
 - When retrieving from the machine's memory
 - When retrieving from USB media
 - When retrieving from a computer
 - When retrieving via a wireless network connection

- 12** After all key display optimization settings have been specified, touch **Edit End**.

* For details on the keys, refer to step **6**.

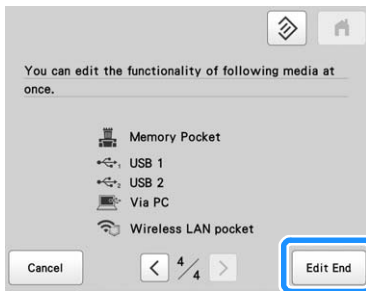

→ The key display optimization settings are specified on the machine.

- To save these settings on USB media, continue with step **13**.
- If the settings will not be saved on USB media, touch **OK**, and then continue to step **15**.

- 13** Insert USB media into USB port 1 or USB port 2.

- 14** Touch the key for the USB port used in step **13**.

→ The key display optimization settings are saved in a folder labeled "bPocket" on the USB media. Touch

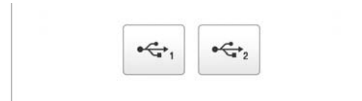



- 15** Touch **OK**.

→ The screens will appear with the specified key display optimization.

Activating/deactivating key display optimization

Key display optimization specified on the machine can be activated or deactivated.

- 1 Touch , then .
→ The general settings screen appears.
- 2 Locate [Key Optimization Mode] in the Settings pages.
- 3 Do one of the following.
 - To activate the optimization settings, touch [ON].
 - To deactivate the optimization settings, touch [OFF].

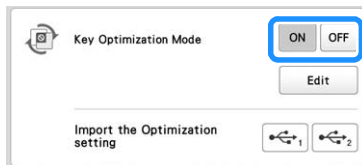





- 4 Touch .
 • When the optimization settings are activated, the screens will appear with the specified key display optimization.
 • When the optimization settings are deactivated, the screens will appear normally.

Recalling key display optimization settings

Key display optimization settings saved on USB media can be recalled.

Memo

- Key display optimization settings cannot be recalled from the embroidering settings screen or embroidering screen.

- 1 Touch , then .
→ The general settings screen appears.
- 2 Locate [Key Optimization Mode] in the Settings pages.
- 3 Insert the USB media containing the optimization settings into USB port 1 or USB port 2.
- 4 Touch  or  beside [Import the Optimization setting].

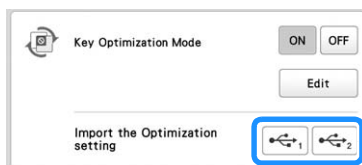

- 5 Select the optimization settings to be recalled, and then touch .



- 6 Touch .
→ The recalled optimization settings are applied to the machine.

Chapter 5 APPENDIX

MAINTENANCE

Simple machine maintenance operations are described below. Always keep the machine clean, otherwise malfunctions may occur.

Cleaning the LCD

If the surface of the LCD is dirty, lightly wipe it with a soft dry cloth.

Cleaning the machine surface

To remove dirt from the machine, use a soft cloth that has been soaked in lukewarm water and then thoroughly wrung dry.

After cleaning the machine, dry it with a soft, dry cloth.

⚠ CAUTION

- Unplug the power supply cord before cleaning the machine, otherwise injuries or an electric shock may occur.

Cleaning the hook

Periodically remove lint and dust for better performance from Hook race area.

Use the included cleaning brush.

- 1 Set the main power switch to "O" to turn off the machine.

⚠ CAUTION

- Unplug the power supply cord before cleaning the machine, otherwise injuries or an electric shock may occur.

- 2 Open the hook cover, and remove the bobbin case. (page 35)

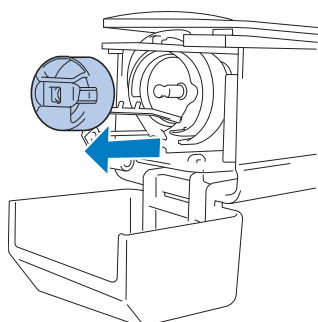

- 3 Use the included cleaning brush to remove any lint and dust from the hook and its surrounding area.

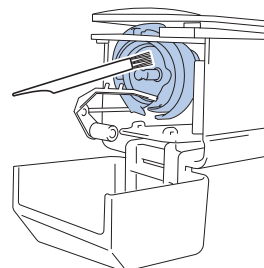

⚠ CAUTION

- If the hook is scratched or damaged, consult your authorized Brother dealer.

- 4 After cleaning is finished, insert the bobbin case into the hook, and then close the hook cover. (page 37)

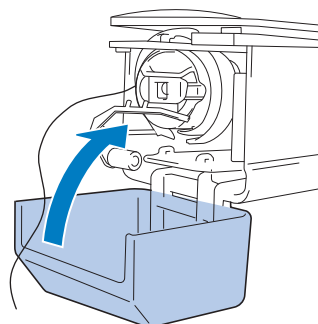

Cleaning around the needle plate

If lint and dust collect around the moving knife, the fixed knife or the thread retaining plate, the thread may not be cut correctly and various parts of the machine may be damaged. Make sure to clean around the needle plate once a month. Use the included 3-way screwdriver and cleaning brush.

- 1 Set the main power switch to "O" to turn off the machine.

⚠ CAUTION

- Unplug the power supply cord before cleaning the machine, otherwise injuries or an electric shock may occur.

- 2 Remove the needle plate.

With the 3-way screwdriver, loosen the screws, remove the needle plate, and then open the hook cover.

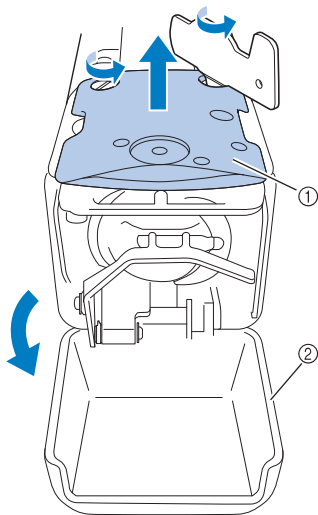

- 1 Needle plate
- 2 Hook cover

- 3 Remove the spacer.

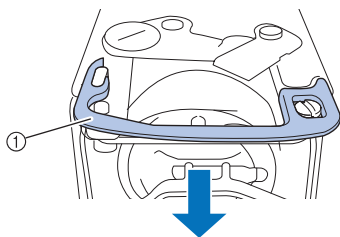

- 1 Spacer

- 4 Use the included cleaning brush to remove any lint and dust from the moving knife, the fixed knife, the thread retaining plate, and their surrounding areas.

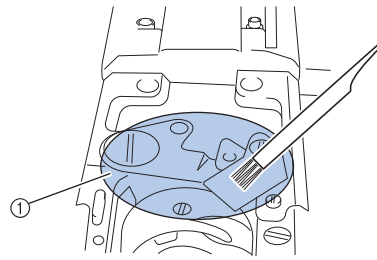

- 1 Remove all lint in this area

- 5 After cleaning is finished, install the spacer back.

First, position the spacer so that it hooks around the elliptical notch, then position the spacer so that it surrounds the screw head. Slide the spacer in the direction of the arrow to secure it.

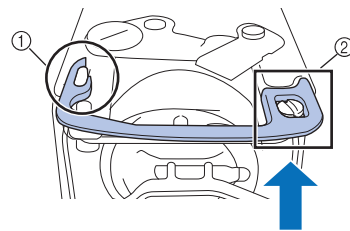

- 1 Elliptical notch
- 2 Screw head

- 6 Attach the needle plate in the opposite way that it was removed in step 2, and then close the hook cover.

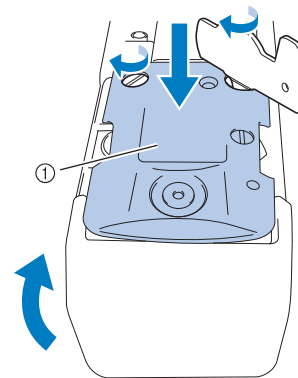

- 1 Needle plate

Cleaning the bobbin case

Thread wax and dust easily collect around the hole in the tension-adjusting spring on the bobbin case, resulting in an incorrect thread tension. Therefore, it should be cleaned each time when the bobbin is changed.

Use a piece of paper with the thickness of a business card.

- 1 Open the hook cover, remove the bobbin case, and then remove the bobbin. (page 35)

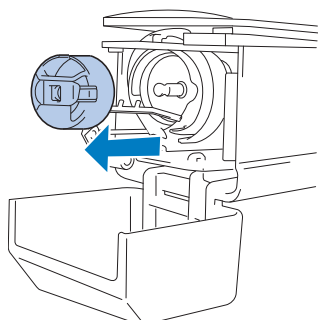

- 2 Slide the paper under the tension-adjusting spring to remove any dust.

Use a corner of the paper to remove any dust from around the hole.

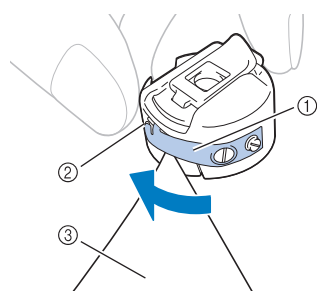

- 1 Tension-adjusting spring
- 2 Hole
- 3 Paper

Note

- Do not bend the tension-adjusting spring. In addition, do not use anything other than thick paper or paper of the specified thickness to clean the bobbin case.

- 3 Use the included cleaning brush to remove any lint and dust from inside the bobbin case.

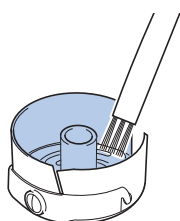

- 4 After cleaning is finished, insert the bobbin into the bobbin case and the bobbin case into the hook, and then close the hook cover. (page 36)

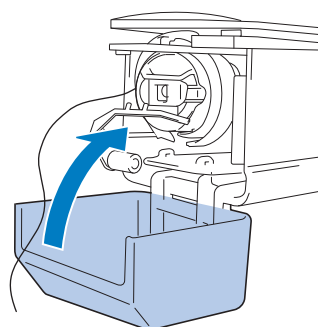

Cleaning the thread paths of the upper threads

If dust or lint has accumulated in the thread guides or tension unit in the paths of the upper threads, the thread may break while embroidery is being performed. Periodically clean the thread paths.

Cleaning the thread guides

- 1 Use the included cleaning brush to remove any lint and dust from below the thread guide plates.

Clean the thread guide plates for both the upper thread guides and the middle thread guides.

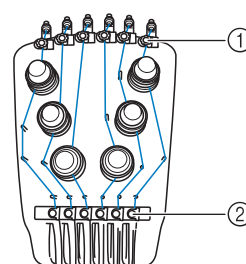

- 1 Upper thread guide
- 2 Middle thread guide

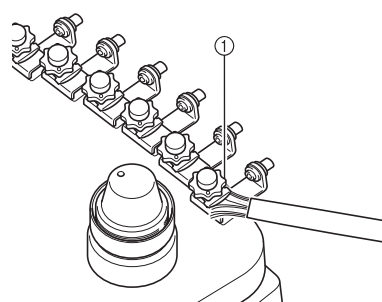

- 1 Thread guide plate

■ Disassembling and cleaning the tension unit

- 1 To remove tension dial, turn dial counterclockwise as shown on illustration.

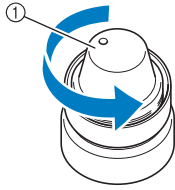

① Tension dial

- 2 Using the included cleaning brush, remove any lint and dust from the two pieces of tension disc washers (top, bottom) inside the tension dial.

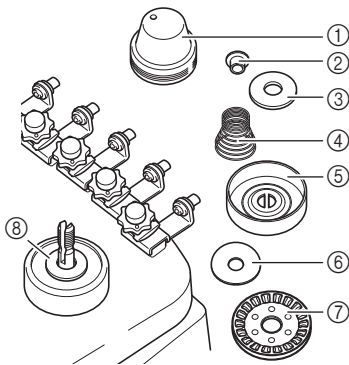

- ① Tension dial
- ② Nylon shoulder washer
- ③ Nylon washer (only for tension number 4)
- ④ Tension spring
- ⑤ Tension base spring
- ⑥ Tension disc washer (top) (thinner than nylon washer)
- ⑦ Tension disc
- ⑧ Tension disc washer (bottom) (thinner than nylon washer)

- 3 Reassembling the tension unit.

Note

- When reassembling the tension unit, be sure not to install the tension disc upside-down. There is a magnet on the bottom.

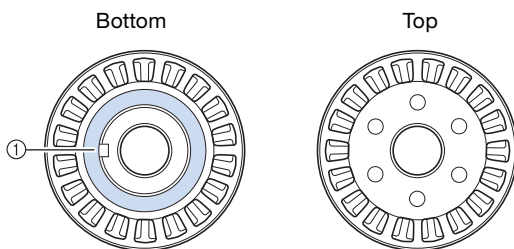

① Magnet

- When reassembling the tension unit, be careful not to lose any parts or install any parts in an incorrect order. The machine may not operate correctly if the tension units are incorrectly reassembled.

Replacing the needle

⚠ CAUTION

- Be sure to turn off the machine before replacing the needle, otherwise injuries may result if the machine starts embroidering.
- Your machine is designed to use household embroidery needles. The factory recommended needle is "HAX 130 EBBR" (Organ). Schmetz needles 130/705 H-E may be used as a substitute.
- Never use bent needles. Bent needles can easily break, possibly resulting in injuries.

Memo

- To check the needle correctly, place the flat side of the needle on a flat surface. Check the needle from the top and the sides. Throw away any bent needles.

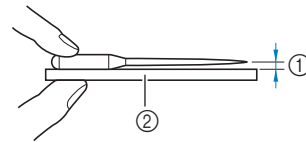

- ① Parallel space
- ② Flat surface (glass, etc.)

- 1 Set the main power switch to "O" to turn off the machine.

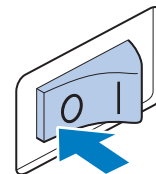

- 2 Loosen the needle set screw and remove the needle.

Hold the needle with your left hand, and then hold the Allen screwdriver in your right hand and turn the needle set screw counterclockwise.

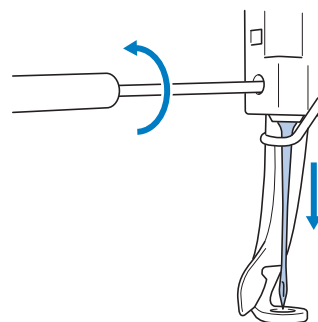

Note

- Be sure to use the included Allen screwdriver to replace the needle.

- Do not apply extreme force when loosening or tightening the needle set screw, otherwise the machine may be damaged.

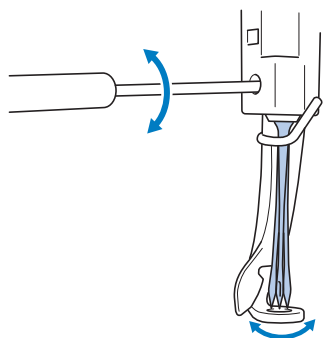

- 3** With the flat side of the needle toward the back of the machine, insert the needle all the way up until it touches the needle bar stopper.

Pass the needle through the hole in the presser foot, and then use the needle changing tool to lift up the needle.

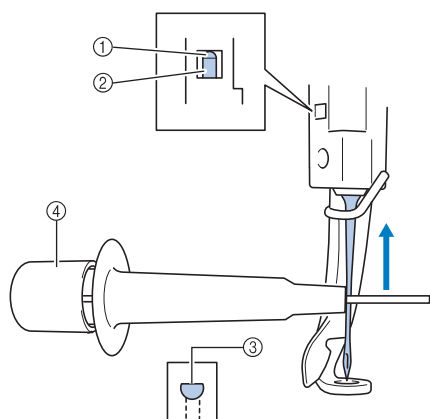

- ① Needle bar stopper
- ② Needle
- ③ Flat side of needle
- ④ Needle changing tool

Hold the needle changing tool and press the end of the needle changing tool ① in to extend the needle-mounting clamp ②. Attach the clamp to the needle, and then release the pressed area to clamp the needle. To unclamp the needle, press ① again.



- ① End of the needle changing tool
- ② Needle mounting clamp

- 4** While holding the needle in place with your left hand, tighten the needle set screw.

Use the Allen screwdriver to turn the needle set screw clockwise.

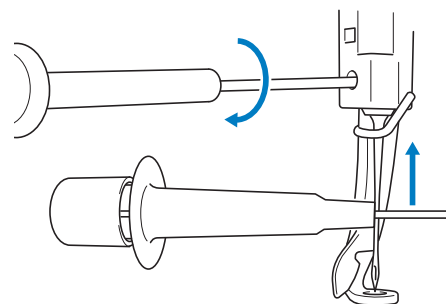

⚠ CAUTION



- Be sure to insert the needle in the needle bar chamber until it reaches the needle bar stopper and securely tighten the needle set screw with the Allen screwdriver, otherwise the needle may break or the machine may be damaged.
- If the needle is not fully inserted, the hook of the automatic needle-threading mechanism will not pass through the eye of the needle during automatic needle threading, and the hook may bend or the needle cannot be threaded.
- If the hook of the automatic needle-threading mechanism is bent or damaged, contact your authorized Brother dealer.

Oiling the machine

In order to extend the life of the machine's parts and keep the machine operating correctly, be sure to oil the machine before the first time that it is used.

Afterward, put a drop of oil onto the hook once a day before use.

Note

- Touch , , , then , in that order, to see a video of how to oil the machine.



Oiling the race

- 1 Touch .

- 2 Touch .

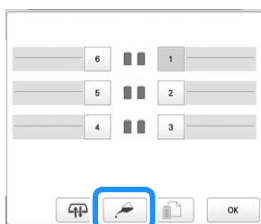

→ Following message appears.



- 3 Open the hook cover, and remove the bobbin case. (page 35)

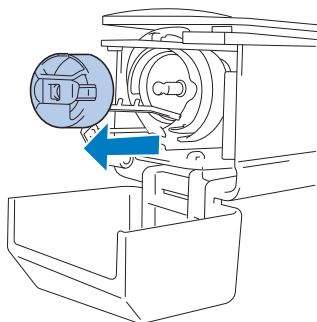

- 4 Touch .

→ The race moves to the correct position for oiling.

- 5 Put a drop of oil onto the hook.

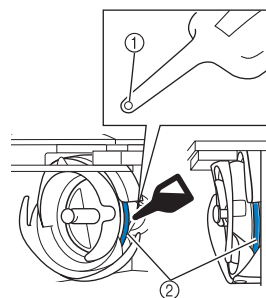

Front angle view

Side view

- ① Punch a small hole in oil bottle.
- ② Apply oil here.

- 6 Touch in the following screen.

→ The race returns to its original position.

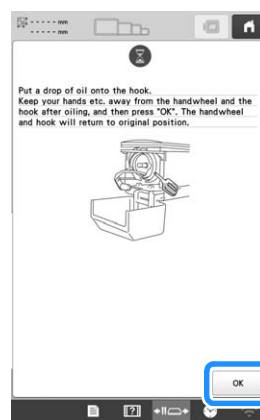

- 7 After oiling, insert the bobbin case into the hook, and then close the hook cover. (page 37)

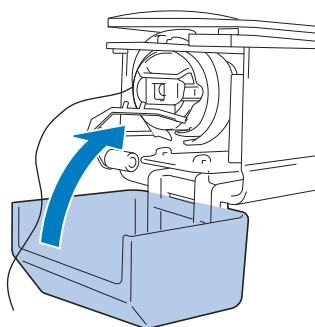

■ Oiling the needle bars

From embroidering screen, select one needle bar at a time. (page 81) Rotate the handwheel toward the LCD panel, bringing the needle bar to its lowest position. Put one drop of oil, as high as possible, on the needle bar above the felt washer.

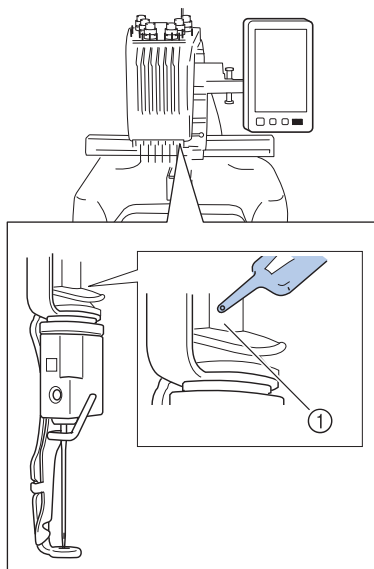

① Apply oil here.

- Too much oil may drip onto embroidery project.

Note

- Put a drop of oil onto the hook once a day before use.
- Apply one drop of oil on the lower needle bar above the felt washer every 40 – 50 hours of embroidering time.
- Apply only machine oil. Use of any other type of oil may result in damage to the machine.
- Do not apply too much oil. Fabric or thread may get contaminated. If too much oil is applied, wipe off any excess with a rag.
- If the thread breaks while embroidering or the operating noise of the hook becomes loud, apply oil onto the race hook.

About the maintenance message



Once this message appears, it is recommended to take your machine to your nearest authorized Brother dealer for a regular maintenance check. Although this message will disappear and the machine will continue to function once

you touch , the message will display several more times until the appropriate maintenance is performed.

Please take the time to arrange for the maintenance that your machine requires as soon as this message appears. Such steps will help to ensure you receive continued, uninterrupted hours of machine operation for the future.

TROUBLESHOOTING



If the machine stops operating correctly, check the following possible problems before requesting service. You can solve most problems by yourself. If you need additional help, the Brother Support website offers the latest FAQs and troubleshooting tips. Visit us at <http://s.brother/cpan/>.

If the problem persists, contact your authorized Brother dealer or the nearest Brother authorized service center.

List of Symptoms

If you have a minor problem with your machine, check the following solutions.

If the reference page is "*" or the suggested remedy does not correct the problem, contact your authorized Brother dealer.



Touch  →  →  for advice about minor embroidering problems during embroidering.

Touch  at any time to return to the original screen.

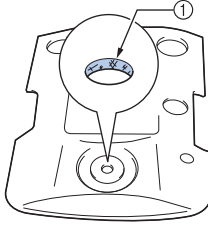
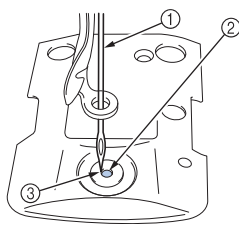
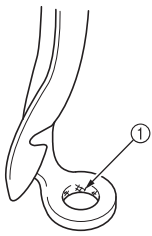
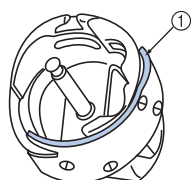
Symptom		
	Probable Cause/Remedy	Page
The machine does not operate.		
	The machine is not turned on.	22
	The machine has not been unlocked.	82
	The "Start/Stop" button was not pressed.	82
The embroidery frame cannot be attached to the machine.		
	The embroidery frame holder attached to the machine is not appropriate for the selected embroidery frame.	67
The embroidery frame cannot be removed or attached.		
	Depending on the position where the machine's carriage has stopped, it may be difficult to remove or attach the embroidery frame. <ul style="list-style-type: none"> Touch the Needle bar/Frame move key to position the carriage, so the embroidery frame can easily be removed or attached. 	67
The needle breaks.		
	The needle is not installed correctly.	140
	The needle set screw is loose.	140
	The needle is bent or blunt.	140

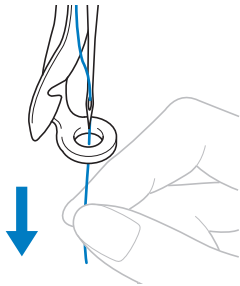
Symptom		
	Probable Cause/Remedy	Page
	The area around the hole in the needle plate is damaged.  <ul style="list-style-type: none"> ① Scratches/Burrs Replace the needle plate. 	*
	The needle hits/touches the needle plate.  <ul style="list-style-type: none"> ① Needle ② Hole in needle plate ③ Needle hits hole Replace the needle. 	140 *
	The presser foot is set too high and not correctly positioned. The needle hits/touches the presser foot.	*
	The area around the presser foot hole is damaged.  <ul style="list-style-type: none"> ① Scratches/Burrs Replace the presser foot. 	*
	Sliding surface on hook race is not smooth. There are scratches or burrs on it.  <ul style="list-style-type: none"> ① Hook race area 	*
	The bobbin or bobbin case is not correctly installed.	35, 37
	The hook is not correctly installed.	*

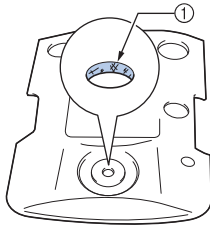
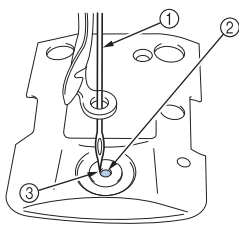
Symptom		
Probable Cause/Remedy	Page	
The needle breaks.		
The hook stopper is not correctly installed, the hook is making a complete rotation.	*	
The upper thread is not threaded correctly. The upper thread is catching somewhere.	77	
 <ul style="list-style-type: none"> • Pull the upper thread by hand from below the presser foot, and check that the thread moves smoothly. If the thread does not move, it is not threaded correctly. Thread the upper thread correctly. Make sure the thread is caught by the needle bar thread guide. 		
The upper thread tension is set too high.	104	
A bobbin designed specifically for this machine is not used.	35	
The needle and the hook are not correctly passing each other. <ul style="list-style-type: none"> • Hook timing may be OFF. 	*	
There is backlash play (forward/backward) in the needle bar case.	*	
The thread density of the embroidery data is too fine. Three or more overlapping stitches are being embroidered. <ul style="list-style-type: none"> • Using a data design system, correct the thread density and over stitching settings in the embroidery data. 	156	
The thread is not cut automatically.		
Lint or dust has accumulated around the needle plate (moving knife, fixed knife or thread retaining plate).	138	
A bobbin case designed specifically for this machine is not used. <ul style="list-style-type: none"> • Use the correct bobbin case. 	—	
Lint or dust has accumulated in the thread tension disc.	140	
After the threads are automatically cut, the upper thread is too short and comes out of the needle.		
Lint or dust has accumulated around the needle plate (moving knife, fixed knife or thread retaining plate).	138	

Symptom		
Probable Cause/Remedy	Page	
The upper thread breaks.		
The needle is not correctly installed.	140	
The needle set screw is loose.	140	
The needle is bent or blunt.	140	
The area around the hole in the needle plate is damaged.	*	
 <p>① Scratches/Burrs</p> <ul style="list-style-type: none"> • Replace the needle plate. 		
The needle is touching the needle plate.	*	
 <p>① Needle ② Needle plate hole ③ Needle touching hole</p>		
The presser foot is set too high and not correctly positioned. The needle hits/touches the presser foot.	*	
The area around the presser foot hole is damaged.	*	
 <p>① Scratches/Burrs</p> <ul style="list-style-type: none"> • Replace the presser foot. 		
Using a specialty thread like a metallic thread. <ul style="list-style-type: none"> • Slow down the machine embroidery speed. 	84	

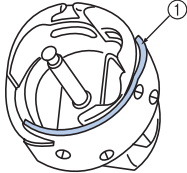
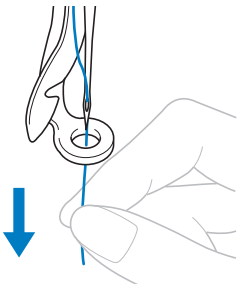

Symptom		
	Probable Cause/Remedy	Page
The upper thread breaks.		
Sliding surface on hook is not smooth. There are burns on it.	 <p>① Hook race area</p>	*
The thread is loose in the hook area.		137
The play between the hook and the race is too much.		*
The hook does not rotate smoothly.	<ul style="list-style-type: none"> Remove lint, clean and apply oil. 	137, 142
The space between the hook stopper and the hook cannot be adjusted.		*
The upper thread is not threaded correctly.	 <ul style="list-style-type: none"> Pull the upper thread by hand from below the presser foot, and check that the thread moves smoothly. If the thread does not move smoothly, it is not correctly threaded. Un-thread the machine and re-thread the machine. Make sure the thread is correctly positioned in the needle bar thread guide. 	77
Upper thread is not positioned in upper or middle thread guide.	<ul style="list-style-type: none"> Make sure thread passes completely under upper and middle thread guide. 	77
There are knots or tangles in the thread.	<ul style="list-style-type: none"> Remove any knots or tangles. 	—
The upper thread tension is too high.		104
The bobbin thread tension is incorrect. The thread does not roll out of the bobbin case smoothly.		102
The bobbin case is damaged.	<ul style="list-style-type: none"> Replace the bobbin case with a new one. 	35
The bobbin thread is not wound correctly.	<ul style="list-style-type: none"> Check that the bobbin is wound so that it is about 80% full and that the thread is evenly wound. If the bobbin is not correctly wound, replace the bobbin with one that is correctly wound or rewind the bobbin. 	35

Symptom		
	Probable Cause/Remedy	Page
A bobbin designed specifically for this machine is not used.		35
The automatic needle-threading mechanism is broken.		*
Adhesive is attached to the needle.	<ul style="list-style-type: none"> Replace the needle. 	140
The fabric is not taut.		63, 64
The thread quality is poor.	<ul style="list-style-type: none"> The thread quality is too weak due to age of thread. Replace thread. 	—
The embroidery data contains stitches with a pitch of zero.		110
The embroidery data contains many stitches with an extremely small pitch.		110
The thread density of the embroidery data is too fine.	<ul style="list-style-type: none"> Using a data design system, correct the thread density and over stitching settings in the embroidery data. 	156
Three or more overlapping stitches are being embroidered.		
Lint or dust has accumulated in the thread tension disc.		140
The bobbin thread breaks.		
The bobbin thread is not correctly threaded.		36
The bobbin is scratched or does not rotate smoothly.	<ul style="list-style-type: none"> Replace the bobbin. 	35
The bobbin case is damaged.	<ul style="list-style-type: none"> Replace the bobbin case. 	35
The thread is tangled.		137
A bobbin designed specifically for this machine is not used.		35
Lint or dust has accumulated in the thread tension disc.		140
Stitches are skipped.		
The upper thread is not threaded correctly.		77
The needle is bent or blunt.		140
The needle is not installed correctly.		140
Dust has accumulated under the needle plate or in the hook.		137, 138
The needle and the hook are not correctly passing each other.		*
The thread twist is either too tight or too loose.	<ul style="list-style-type: none"> Improper twisting results in irregular loop formation. Try using a new spool. 	—

Symptom		
Probable Cause/Remedy		Page
The embroidery pattern is misaligned.		
The thread is tangled. • Use tweezers to remove any tangled thread from the hook.		—
The fabric is not secured in the embroidery frame (for example, the fabric is not taut).		63, 64
The embroidery frame is too large for the size of the embroidery.		67
The thumb screws on the embroidery frame holder are loose.		21
Appropriate stabilizer (backing) is not used.		62
The embroidery frame is not correctly attached to the carriage. • Correctly attach the embroidery frame to the carriage. Make sure that the pins on the left and right arms of the embroidery frame holder securely fit into the holes in the handles on the embroidery frame.		66
The carriage or the embroidery frame is hitting objects. • The pattern may become misaligned if the carriage or embroidery frame is hitting objects.		—
The fabric is caught or pinched. • Stop the machine, and then correctly position the fabric.		—
The carriage moved while removing embroidery frame. • The pattern may become misaligned if the presser foot was hit or the carriage was moved while embroidery. • Be careful when removing and reattaching the embroidery frame while embroidery. If the carriage is moved, turn the machine off, then on again. The correct frame position at the time that the machine was stopped is stored in the machine's memory, and the embroidery frame is returned to the correct position.		—
The design was not digitized correctly. • The design may need more pull compensation or underlay to accommodate stretchy or high-napped fabrics.		—
The size of the installed embroidery frame is not correctly detected.		
The thumb screws on the embroidery frame holder are loose.		21
The starting position for the embroidery frame is horizontally misaligned.		
The thumb screws on the embroidery frame holder are loose.		21

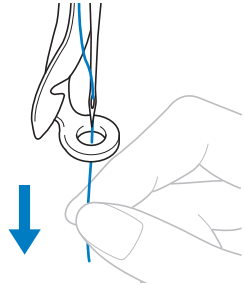
Symptom		
Probable Cause/Remedy		Page
There are loops in the upper thread.		
The upper thread tension is low. 		—
• After passing the upper thread through the hole in the presser foot, pull the thread by hand to check the thread tension. If it is difficult to determine, compare it with other needle bars where looping does not occur.		
The thread tension does not correspond to the amount that the thread tension knob was tightened. • If the thread tension cannot be adjusted, thread wax and dust may have collected in the upper or middle thread guides, causing the thread guide plates to rise. Clean the thread guide plates.		139
Thread is not correctly threaded around thread tension discs. • Clean thread tension discs. Rethread and make sure thread tension discs rotate when pulling on thread.		140
The thread quality is poor. • Try embroidery with different thread. If the problem no longer occurs after the thread is changed, the thread quality is the problem. Replace the thread with one of good quality.		—
The machine is noisy.		
Lint may be wound in the hook.		137
The upper thread is not threaded correctly.		77
The hook is damaged. • Replace the hook.		*
Not enough oil was applied.		142
The needle threader cannot be used.		
The needle is not at the correct position. • Touch the key to move the desired needle bar to be threaded into embroidering position.		81
Recommended needles are not used on this machine.		140
The needle is not installed correctly.		140
The hook on the automatic needle-threading mechanism is bent.		*

Symptom		
	Probable Cause/Remedy	Page
The thread tension is incorrect.		
	The upper thread is not threaded correctly.	77
	The bobbin thread is not correctly threaded.	36
	The bobbin thread tension is incorrect.	102
	Lint or dust has accumulated in the thread tension disc.	140
The upper thread comes out of the needle when embroidering begins.		
	If a short length of thread remains after the thread is trimmed, the needle may become unthreaded when embroidering begins again. <ul style="list-style-type: none"> Set the remaining length of thread to [Long Tail] on settings screen. 	110
The upper thread does not reach the bobbin thread when embroidering begins.		
	There is no more thread in the bobbin, the thread does not feed from the bobbin, or the thread that is fed from the bobbin is too short. <ul style="list-style-type: none"> Correctly thread the bobbin thread. 	36
Although the thread is not broken, a broken thread error occurs and the machine stops.		
	If the thread breakage sensor in the thread tension disc of the thread tension knobs cannot detect that the thread is being fed, even if the machine is running, a broken thread error occurs and the machine is stopped. <ul style="list-style-type: none"> Correctly pass the thread through the thread tension disc. If the broken thread error occurs after the machine is rethreaded, the sensor may be damaged. 	140 *
The thread is worn.		
	Lint or dust has accumulated in the thread tension disc.	140
Jump stitches are long.		
	Lint or dust has accumulated in the thread tension disc.	140
	Long jump stitches have been specified.	109
There are needle cuts or holes in the garment.		
	The needle is dull. <ul style="list-style-type: none"> Replace the needle. Dull needles have a difficult time passing through the garment, causing fabrics to tear. 	140
	The fabric is too delicate. <ul style="list-style-type: none"> The simple penetration of the needle could damage delicate fabrics. Use stabilizer on top of fabric. 	—



Symptom		
	Probable Cause/Remedy	Page
Fabric is puckering.		
	The thread tension is too tight. <ul style="list-style-type: none"> Adjust the tension according to the type of fabric and thread being used. Polyester thread will stretch during embroidery especially if the tensions are set too high. After the stitching is complete, the thread returns to its original strength, causing puckers in the fabric. 	104
	The framing tension of the fabric is incorrect. <ul style="list-style-type: none"> Tightly frame non-stretchable, woven fabrics. Loose framing will cause the fabric to bunch up under the stitching. Tautly frame soft knits using a stable backing. Overstretching the garment will cause it to look puckered when the frame is removed. 	—
	The column stitches are too long. <ul style="list-style-type: none"> Re-digitize the design with fill stitching or with multiple rows of column stitching. 	—
	The needle is dull. <ul style="list-style-type: none"> Dull needles push fabric down and damage material. Replace the needle. 	140
	The design density is too heavy. <ul style="list-style-type: none"> Too many stitches in an area pull fabric, causing it to pucker. Slightly decrease the design density by 5% to 10%. 	110
The LCD cannot be read.		
	The LDC screen is too bright or too dark. <ul style="list-style-type: none"> Adjust the brightness of the screen display. 	—
When embroidering thick fabric, the fabric cannot be correctly hooped.		
	Fabric slips within the frame because of its thickness. <ul style="list-style-type: none"> Wrap masking tape or bias tape around the outer frame. The tape will provide resistance so that the fabric does not easily slip. 	—
The embroidery crosshair positioning laser is hard to see.		
	The embroidery crosshair positioning laser is too bright or too dim. <ul style="list-style-type: none"> Adjust the brightness of the embroidery crosshair positioning laser. 	74
I forgot my administrator lock passcode.		
	<ul style="list-style-type: none"> Check with the administrator who specified the passcode. If the wrong passcode is entered 10 times, the passcode will be reset. The initial passcode is 999999. 	129
I forgot my operator lock passcode.		
	<ul style="list-style-type: none"> Check with the administrator who specified the passcode. If the wrong passcode is entered 10 times, the passcode will be reset. The initial passcode is 9999. 	130

CAUTION

- This machine is equipped with a thread detecting mechanism. If the machine is not threaded with the upper thread, the machine will not operate correctly, even if the “Start/Stop” button is pressed after unlocking the machine.
- If the machine suddenly stops:
 - Turn off the machine, and unplug the power cord.
 - Restart the machine with the correct operating procedure. (page 22)





Error messages

If the "Start/Stop" button is pressed while the machine is not correctly set up or if an incorrect operation is performed, the machine stops and informs you of the error with a buzzer and an error message. If an error message appears, correct the problem according to the instructions in the message.

To close the message, touch  or perform the correct operation, then touch . If the message appears again, consult your nearest authorized Brother dealer.

	Error messages	Cause/solution
1	Cannot change the configuration of the characters.	This message is displayed when there are too many characters in the curved text arrangement. Change the text arrangement or the embroidery frame.
2	Cannot communicate between PC and machine. Please check the USB cable connections to run the Link application.	This message is displayed when the machine cannot receive any data from the computer in the Link mode with the USB cable connection. Turn off the machine, and check the USB connection. After connecting the USB cord securely, turn on the machine again. (page 117)
3	Cannot connect to the PC. Please check the wireless network connection.	This message is displayed when the machine cannot receive any data from the computer in the Link mode with the wireless LAN connection. Check the wireless LAN connection between the computer and the machine, and then turn off and on the machine. (page 117)
4	Cannot recognize the data for the selected pattern. The data may be corrupted. Please turn off the power and turn on again.	This message is displayed when trying to recall damaged pattern data or data created using another manufacturer's data design system. Turn the machine off, then on again to return it to its normal condition.
5	Change to a larger embroidery frame.	This message is displayed when the thumb screws of the embroidery frame holder are loose. Using the included 3-way screwdriver, firmly tighten the two thumb screws. (page 66)
		This message is displayed when the installed embroidery frame is too small. Check which embroidery frames can be used, and then install a larger embroidery frame. (page 63)
6	Check upper and bobbin thread.	This message is displayed when the thread tension is too tight. Check the tensions of the upper thread and bobbin thread, and then adjust them. (page 102)
		This message is displayed when the upper thread breaks or the thread comes out of the thread tension disc or a thread guide. Check that the thread passes under the upper and middle thread guides, and correctly thread the upper thread. (page 77)
		This message is displayed when lint or dust has accumulated in the thread tension disc. Remove the tension dials, and then remove any lint or dust accumulated between the tension disc washers. (page 140)
		This message is displayed when the bobbin thread breaks or runs out. Check that there is thread on the bobbin and that approximately 50 mm (2 inches) of thread has been pulled out, and then re-install the bobbin. (page 35)
		This message is displayed when there may be another cause. Refer to "The upper thread breaks." on page 145 or "The bobbin thread breaks." on page 146. Touch  to advance or reverse through the stitching. (page 89)
7	Communication error.	When this message is displayed, consult your nearest authorized Brother dealer.
8	Communication time out error.	When this message is displayed, consult your nearest authorized Brother dealer.
9	Data receiving command error.	When this message is displayed, consult your nearest authorized Brother dealer.
10	EEPROM read/write error.	When this message is displayed, consult your nearest authorized Brother dealer.
11	Embroidering stop.	When this message is displayed, consult your nearest authorized Brother dealer.

	Error messages	Cause/solution
12	Failed to save file.	This message is displayed when you try to save more than 100 settings screen image files in the USB media. In this case, delete a file from the USB media or use different USB media.
13	Go to Embroidering Screen and press the unlock key.	This message is displayed when the thread trimming button is pressed while a screen other than the embroidering screen or embroidering settings screen is displayed. Display either the embroidering screen or embroidering settings screen.
14	Impossible to set the start & the end points.	This message is displayed when embroidery cannot begin from the specified starting position. Change the starting position or move the frame and change the embroidering position. (page 112)
15	Inappropriate needle stop position	This message is displayed when the needle has stopped at an incorrect position. Turn the handwheel so that the mark on the handwheel is at the top, and then touch <input type="button" value="OK"/> .
16	Includes a special pattern that cannot be saved to external memory. Save the pattern in the machine's memory.	This message is displayed when you try to save a copyright protected pattern to USB media or computer. According to copyright laws, patterns that are illegal to reproduce or edit cannot be saved to USB media or computer. If this message is displayed, save the pattern in the machine's memory.
17	Machine PCB power off.	When this message is displayed, consult your nearest authorized Brother dealer.
18	Machine PCB reset.	When this message is displayed, consult your nearest authorized Brother dealer.
19	Main motor current error.	When this message is displayed, consult your nearest authorized Brother dealer.
20	Main motor encoder connect error.	When this message is displayed, consult your nearest authorized Brother dealer.
21	Main motor encoder signal error.	When this message is displayed, consult your nearest authorized Brother dealer.
22	Main motor rotate error.	When this message is displayed, consult your nearest authorized Brother dealer.
23	Main motor speed error.	When this message is displayed, consult your nearest authorized Brother dealer.
24	Needle bar case home position error.	This message is displayed when the needle bar case cannot be moved to its initial position. Touch <input type="button" value="OK"/> to automatically reset the needle bar case.
25	Needle bar case position error	This message is displayed when the needle bar case has stopped at an incorrect position. Touch <input type="button" value="OK"/> to automatically reset the needle bar case.
26	Needle case motor has been locked.	This message is displayed when the needle bar case motor has locked up. Touch <input type="button" value="OK"/> to automatically reset the needle bar case.
27	Needle threader error	This message is displayed when the automatic needle-threading mechanism does not operate correctly. Remove the thread entangled in the automatic needle-threading mechanism, and then touch <input type="button" value="OK"/> .
28	Needle threader is in threading position.	This message is displayed when another operation is performed while the automatic needle-threading mechanism is threading the needle. Press the automatic needle-threading button, and then perform the other operation after the needle is threaded. (page 80)
29	No more patterns can be added to this combination.	This message is displayed when trying to combine 101 or more patterns. Up to 100 patterns can be combined.
30	Not enough available memory to save the pattern. Delete another pattern?	This message is displayed when the pattern cannot be saved because the memory is full. Delete some patterns.
31	Not enough space. Delete some patterns or use a different USB media.	This message is displayed when the memory capacity of the USB media has been exceeded. Delete some patterns or use a different USB media.

	Error messages	Cause/solution
32	OK to recall and resume previous memory?	This message is displayed when the machine is turned off, then on again before embroidering is completed. Touch  to resume embroidering. If the embroidering screen was displayed before the machine was turned off, back up several stitches, and then continue embroidering. (page 92)
33	OK to revert to previous color changes?	This message is displayed when  is touched while thread colors are being changed.
34	OK to separate the combined border pattern?	This message is displayed when a combined border pattern is being rotated in the embroidering settings screen.
35	Panel communication error.	When this message is displayed, consult your nearest authorized Brother dealer.
36	Pattern extends to the outside of embroidery frame. Add no additional characters.	This message is displayed when the entered character patterns exceed the width of the embroidery frame.
37	Pattern extends to the outside of embroidery frame. This function cannot be used at this time.	This message is displayed when the font of the character pattern is changed to one with a larger size, causing the pattern to extend beyond the embroidery frame.
38	Picker error	This message is displayed when the thread picker (page 35) does not operate correctly. Remove the thread entangled on the thread picker, and then touch  .
39	Please set up the "Thread antenna"	This message is displayed when thread guide assembly support is not prepared. Prepare the thread guide assembly. (page 19)
40	Power supply voltage error.(24V high)	When this message is displayed, consult your nearest authorized Brother dealer.
41	Power supply voltage error.(24V low)	When this message is displayed, consult your nearest authorized Brother dealer.
42	Power supply voltage error.(40V high)	When this message is displayed, consult your nearest authorized Brother dealer.
43	Power supply voltage error.(40V low)	When this message is displayed, consult your nearest authorized Brother dealer.
44	Press the unlock key to unlock the machine.	This message is displayed when the thread trimming button is pressed before the machine is unlocked. Touch  to use the thread trimming function.
45	Preventive maintenance is recommended.	This message is displayed when the machine needs maintenance. (page 143)
46	Select a pattern.	This message is displayed when there is no embroidery pattern selected and the "Start/Stop" button is pressed.
47	Set the clock.	This message is displayed when the time/date is not set. Set time/date. (page 23)
48	Stop while needle bar case transferring.	This message is displayed when the machine has stopped while the needle bar case is moving. Touch  to automatically reset the needle bar case.

	Error messages	Cause/solution													
49	The authentication and encryption methods used by the selected wireless LAN access point/router are not supported by your machine.	<p>The authentication/encryption methods used by the selected wireless access point/router are not supported by your machine. For infrastructure mode, change the authentication and encryption methods of the wireless access point/router. Your machine supports the following authentication methods:</p> <table border="1" data-bbox="774 367 1436 788"> <thead> <tr> <th data-bbox="774 367 1018 454">Authentication method</th> <th data-bbox="1018 367 1436 454">Encryption method</th> </tr> </thead> <tbody> <tr> <td data-bbox="774 454 1018 548" rowspan="2">WPA-Personal</td> <td data-bbox="1018 454 1436 499">TKIP</td> </tr> <tr> <td data-bbox="1018 499 1436 548">AES</td> </tr> <tr> <td data-bbox="774 548 1018 642" rowspan="2">WPA2-Personal</td> <td data-bbox="1018 548 1436 593">TKIP</td> </tr> <tr> <td data-bbox="1018 593 1436 642">AES</td> </tr> <tr> <td data-bbox="774 642 1018 739" rowspan="2">Open</td> <td data-bbox="1018 642 1436 687">WEP</td> </tr> <tr> <td data-bbox="1018 687 1436 739">None (without encryption)</td> </tr> <tr> <td data-bbox="774 739 1018 788">Shared key</td> <td data-bbox="1018 739 1436 788">WEP</td> </tr> </tbody> </table> <p>If your problem is not solved, the SSID or network settings you entered may be incorrect. Reconfirm the wireless network settings. Refer to “How can I find the wireless security information (SSID and network key)” on page 154.</p>	Authentication method	Encryption method	WPA-Personal	TKIP	AES	WPA2-Personal	TKIP	AES	Open	WEP	None (without encryption)	Shared key	WEP
Authentication method	Encryption method														
WPA-Personal	TKIP														
	AES														
WPA2-Personal	TKIP														
	AES														
Open	WEP														
	None (without encryption)														
Shared key	WEP														
50	The machine is still trying to connect to your wireless network.	The machine is still trying to connect to your wireless network. Please wait a few minutes, and then check the WLAN status.													
51	The pattern combination is too large for the extra large embroidery frame. If you plan to add more patterns, rotate the pattern combination.	This message is displayed when a long vertical pattern is recalled and no longer fits in the embroidery frame. Rotate the pattern 90 degrees.													
52	The safety device has been activated. Is the thread tangled? Is the needle bent?	This message is displayed when a malfunction occurred, such as the thread becoming tangled or the needle is bent. The machine stops when it detects a malfunction. Check that the machine is correctly threaded (page 77) and that the needle is not bent.													
53	The SSID and Network Key are incorrect.	The security information (SSID and network key (password)) is incorrect. Reconfirm the security information (SSID and network key (password)). Refer to “How can I find the wireless security information (SSID and network key)” on page 154.													
54	The wireless LAN access point/router cannot be detected.	<p>The wireless access point/router cannot be detected.</p> <ol style="list-style-type: none"> Check the following 4 points. <ul style="list-style-type: none"> Make sure that the wireless access point/ router is powered on. Move your machine to an area with no items which obstruct the wireless network signal, such as metal doors or walls, or closer to the wireless access point/router. Temporarily place your machine within about 1 m (3.3 feet) from the wireless access point when you are configuring the wireless settings. If your wireless access point/router is using MAC address filtering, confirm the MAC address of this machine is allowed in the filter. If you manually entered the SSID and security information (SSID/ authentication method/encryption method/ network key (password)), the information may be incorrect. Reconfirm the SSID and security information and re-enter the correct information as necessary. <p>Refer to “How can I find the wireless security information (SSID and network key)” on page 154.</p>													
55	The wireless security information (Authentication method, Encryption method, Network Key) is incorrect.	<p>The wireless security information (authentication method/encryption method/ network key (password)) is incorrect. Reconfirm the wireless security information (authentication method/ encryption method/ network key (password)) in the table of the error message “The authentication and encryption methods used by the selected wireless LAN access point/router are not supported by your machine.” Refer to “How can I find the wireless security information (SSID and network key)” on page 154.</p>													
56	The wireless setting is not activated.	The wireless network setting is not activated. Activate the wireless network. (page 31)													

	Error messages	Cause/solution
57	This file cannot be used.	This message is displayed when the file format is incompatible with this machine. Check the list of compatible file formats. (page 156)
58	This pattern cannot be used since it exceeds the data capacity.	This message is displayed when the pattern has too many stitches and cannot be used. Data with stitches that exceed specifications (500,000 stitches) cannot be displayed. Use data design software to reduce the number of stitches.
59	This pattern cannot be used.	This message is displayed when you try to retrieve a pattern that was downloaded for a different machine.
60	This pattern cannot combine.	This message is displayed when a split (large-size) pattern is selected to be combined with another embroidery pattern.
61	Trimming sensor error.	This message is displayed when lint or dust may have accumulated within the moving knife, the fixed knife, the thread retaining plate, and their surrounding areas. Clean them. (page 138)
62	USB media error	This message is displayed when USB media cannot be read correctly or when USB media is damaged. Touch <input type="button" value="OK"/> and try again.
63	USB media is not loaded. Load USB media.	This message is displayed when you tried to recall or save a pattern while no USB media is loaded. Load USB media.
		This message is displayed when you try to use incompatible USB media. For a list of compatible USB media, visit http://s.brother/cpban/ .
64	Wiper error	This message is displayed when thread is tangled on the wiper. Remove the tangled thread.
		This message is displayed when lint or dust may have accumulated within the moving knife, the fixed knife, the thread retaining plate, and their surrounding areas. Clean them. (page 138)
		This message is displayed when the thread does not pass through the groove in the thread cutter. Pass the thread through the groove securely.
65	X-axis home position error.	When this message is displayed, consult your nearest authorized Brother dealer.
66	XY moving error.	When this message is displayed, either replace the embroidery frame with a larger one or return to the pattern editing screen and move the pattern position.
67	Y-axis home position error.	When this message is displayed, consult your nearest authorized Brother dealer.

How can I find the wireless security information (SSID and network key)

1. You should see the documentation provided with your wireless access point/router.
2. The default SSID (wireless network name) could be the manufacturer's name or the model name.
3. If you do not know the security information, please consult the router manufacturer, your system administrator, or Internet provider.
4. Some SSIDs and network keys (passwords) are case (upper case and lower case) sensitive. Please properly record your information.

* The network key may also be described as the password, security key or encryption Key.

* If the wireless access point/router is not broadcasting the SSID, the SSID will not automatically be detected. You will have to manually enter the SSID.

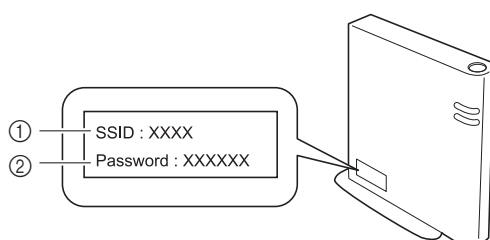

- ① SSID
- ② Network key (password)

If the machine does not respond when a key is touched

If nothing happens when a key on the screen is touched (no key can be selected or the keys are misaligned), adjust the touch panel as described below.

- 1 Touch anywhere inside the touch panel, and turn the machine off, then on again.

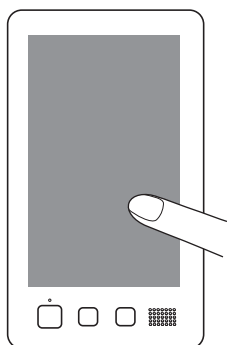

- Continue touching the touch panel until the screen shown below appears.
 - The "Start/Stop" button is red.
- The adjustments screen appears.

- 2 Use the included touch pen to touch the center of the numbered crosses on the screen, in numerical order from 1 to 13.

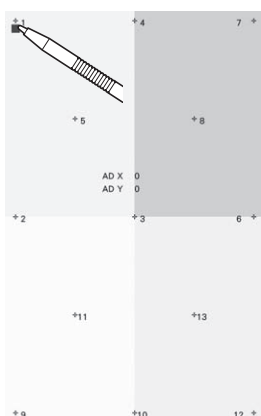

⚠ CAUTION

- Be sure to use the included touch pen to adjust the touch panel. Do not use a mechanical pencil, screwdriver or any other hard or sharp object. Do not apply pressure to the LCD screen display, otherwise damage to the display may result.

- 3 After making the necessary touch panel adjustment, [SUCCESS] will show on the screen.

- If the buzzer sounds when cross number 13 is touched, an error occurred during setting, and [ERROR] appears on the screen. Touch the crosses again, starting with the number indicated on the screen.

Note

- If the keys still do not respond, even after the touch panel is adjusted, or if the touch panel cannot be adjusted, contact your nearest authorized Brother dealer.

- 4 Turn the machine off, and on again.

SPECIFICATIONS

Machine specifications

Item	Specification		
Weight	38 kg (83 lb)		
Machine size	512 (W) × 587 (D) × 762 (H) mm (20-5/32 (W) × 23-7/64 (D) × 30 (H) inches)		
Embroidery speed	Speed range / Max.: 1,000 spm, Min.: 400 spm Depending on the embroidery frame, maximum stitches in one minute is 600.		
Hook Type	Vertical fully rotary hook		
Hook size	Normal size (Type L)		
Needle	HA130EBBR / #11		
Number of needle	6 needles		
Thread tension	Manual		
Thread trimming	Upper and bobbin thread		
Thread breakage sensor	Yes / Upper thread and bobbin thread		
Automatic needle threader	Yes		
Connecting your machine to PC	Compatible interfaces	USB ^{*1} / Wireless LAN ^{*2}	
	Compatible models	IBM PC with a USB port as standard equipment IBM PC-compatible computer equipped with a USB port as standard equipment	
	Compatible operating systems	Microsoft Windows 8.1, Windows 10	
Memory	Embroidery patterns	10 MB	
Data Types	Embroidery patterns ^{*3}	.pes .phc .phx .dst .pen	
Data Size	Embroidery patterns	Up to 300 mm (W) × 200 mm (H) (approx. 11-3/4 inches (W) × 7-7/8 inches (H))	
	.pes files that can be displayed	Up to 500,000 stitches	
		Up to 127 color changes	
Types of USB Devices/ Media that can be Used ^{*4}	Embroidery patterns	Embroidery data can be saved to or recalled from USB media. Use media that meets the following specifications: <ul style="list-style-type: none"> • USB Flash drive (USB Flash memory) Embroidery data can be recalled only: <ul style="list-style-type: none"> • USB external CD/DVD drives 	
Condition of the [Eco Mode] and [Shutoff Support Mode]	[Eco Mode]	Available time	[OFF], 10 - 120 (minute)
		“Start/Stop” button	Green flashing
		Suspended function	Machine light, Embroidery crosshair positioning laser, Screen display
		After recovering	The machine starts from the previous operation.
	[Shutoff Support Mode]	Available time	[OFF], 1 - 12 (hour)
		“Start/Stop” button	Green slow flashing
		Suspended function	All functions
		After recovering	An error message appears. You need to turn off and on the machine to restart.

Item	Specification	
Compatible image files of the Screen Saver Image	Format	JPEG format (.jpg)
	File size	Max. 2 MB for each image
	File dimension	1280 (H) × 1200 (W) pixels or less (If the size is more than 1280 (H) × 800 (W) pixels, the image will be displayed in a smaller size.)
	Number allowed	5 or less
Videos that can be played	MP4 file format	Video - H.264/MPEG-4 AVC, Audio – AAC
	Size	1280 (H) × 800 (W) pixels or less (If the size is more than 450 (H) × 800 (W) pixels, the video will be displayed in a smaller size.)
	Maximum file size	100 MB

- *1 Do not create folders in “Removable Disk” on a computer.
If embroidery data is stored in a folder in “Removable Disk”, that embroidery data cannot be retrieved by the machine.
- *2 The wireless network connection complies with IEEE 802.11 b/g/n standards and uses the 2.4 GHz frequency.
A wireless network cannot be set up with WPA/WPA2 Enterprise.
- *3 Using data other than that saved using our data design systems or this machine may cause this machine to malfunction.
When the machine is used to save a file with any extension, it is saved as a .phx data file.
Since Tajima (.dst) data does not contain specific thread color information, it is displayed with our default thread color sequence.
Check the preview and change the thread colors as desired.
- *4 USB media is commercially available, but some USB media may not be usable with this machine.
Please visit our website <http://s.brother/cpban/> for more details.
- * Depending on the type of USB devices/media being used, either directly plug the USB device into the machine’s USB port or plug the USB media Reader/Writer into the machine’s USB port.
- * Please be aware that some specifications may change without notice.

⚠ CAUTION

- **When using embroidery data other than our original patterns, the thread or needle may break when embroidering with a stitch density that is too fine or when embroidering three or more overlapping stitches. In that case, use one of our original data design systems to edit the embroidery data.**

UPDATING YOUR MACHINE'S SOFTWARE

You can update your machine's software using the following two procedures.

- Using a wireless LAN connection to update
- Using USB media to update

Using a wireless LAN connection to update

When the machine is connected to a wireless network, update files can be downloaded directly to the machine. For details on the wireless LAN connection, refer to page 30.

1 Touch .





Memo

- The machine periodically checks if there is a new update file on the server. When there is a new update file, the wireless LAN key is displayed as  in the lower-right corner of the screen.

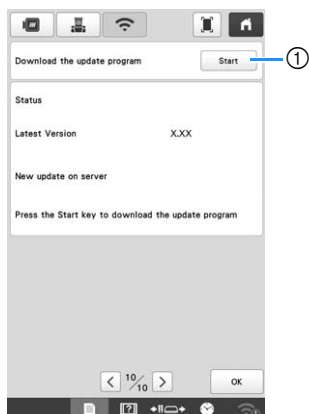

2 Touch beside [Download the update program].

→ The machine starts to download the update file.



- ① When the wireless LAN key in the lower-right corner of the screen appears as , touching  causes the machine to check if there is a new update file. If there is a new file, downloading begins.

Note

- Do not turn off the machine during the download.
- Touch  to pause the download. To restart, touch .

3 Turn off the machine after downloading is complete.

4 While pressing the automatic needle-threading button, turn the main power on.

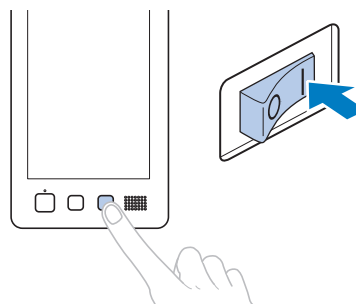

→ The following screen will appear on the LCD.

5 Touch to update the machine.

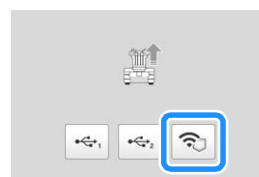

6 Touch to update the machine.

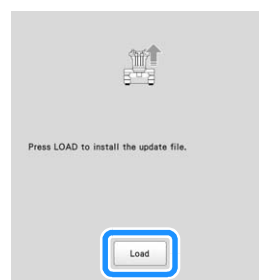

Note

- Do not turn off the machine during the update.
- If an error occurs, a red text error message will appear. When the update is performed successfully, the following message will appear.

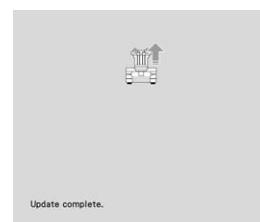

7 Turn the machine off and on again.

Using USB media to update

The machine's software can be updated using USB media. For update information, refer to the Brother support website <http://s.brother/cuban/>. If an update file is posted, download the file, and then update the machine according to the following procedure.

- 1 While pressing the automatic needle-threading button, turn the main power on.

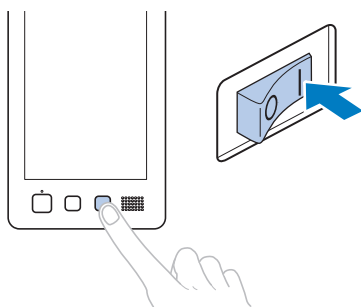

→ The following screen will appear on the LCD.

- 2 Touch or .



- 3 Insert the USB media into the USB port selected in step 2.

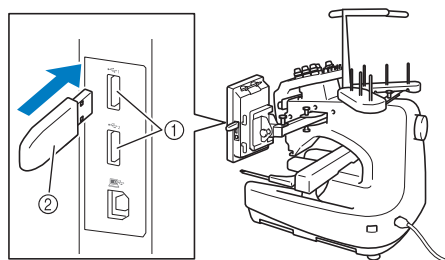

- 1 USB port
- 2 USB media

Note

- Save only the update file on the USB media.

- 4 Touch to update the machine.



Note

- Do not turn off the machine during the update.
- If an error occurs, a red text error message will appear. When the update is performed successfully, the following message will appear.

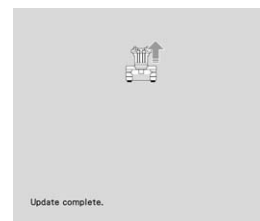

- 5 Remove the USB media, and turn the machine off and on again.

INDEX

Symbols

"DST" Setting 109

A

AC adapter 124
Adjusting
 legs 18
 operation panel 18
 touch panel 155
Administrator mode 129
 administrator lock 129
 key display optimization 132
 operator lock 130
Aligned characters 114
Appliqué alphabet 43
Appliqué embroidery 94
Automatic lock stitch 72
Automatic needle-threading button 12, 80
Automatic needle-threading mechanism 80

B

Basic procedures 35
Basting 93
Bobbin case 35, 139
 removing 35
Bobbin winder 123
Border function 51

C

Canton fleece 62
Canvas 62
Carriage 11
Change thread color key 47, 55, 56
Changing
 basting distance 110
 colors of the pattern 55
 display guides 109
 thread color display 109
 thread density 50
Checking
 needle bars and thread colors 76
 preview image 61
 thread spool changes 86
Cleaning
 around the needle plate 138
 bobbin case 139
 hook 137
 LCD 137
 machine surface 137
 maintenance message 143
 oiling machine 142
 thread paths 139
Clock set 23, 24
Color Shuffling 56
Combining patterns 44
Corduroy 63
Cotton sheeting 62

D

Delete key 47
Deleting
 short stitches 110
Denim 62
Density key 48, 50
Display guides 109

Distance from center (horizontal) 46
Distance from center (vertical) 46
Dress shirt (woven) 62

E

Edit end key 47
Edit key 71
Editing 46
 restart from beginning or middle 91
Embroidering screen 76, 84
Embroidering settings screen 70
Embroidering time 85
Embroidery 82
 aligned characters 114
 baseline on the fabric 115
 repeating along a diagonal 113
 small fabric 65
Embroidery crosshair positioning laser 74, 98
Embroidery frame
 attaching to the machine 66
 types 68
Embroidery frame holder
 attaching 21
Embroidery frame holders 67
Embroidery frame indicators 46, 63, 70
Embroidery key 71
Embroidery light 11
Embroidery patterns
 editing 46
 selecting 37
Embroidery setting key 85
Embroidery sheet 64
Embroidery thread 77
Error messages 150

F

Fabric/stabilizer compatibility chart 62
Feet 11
Forward/Backward stitch key 85, 89, 91

G

Going back through the stitching 89, 91
Golf shirt 62
Grouping 45

H

Handwheel 11
Headwear 62
Hook 137
Hook cover/Hook 11
Hooping 64
Horizontal mirror image key 48

I

Included accessories 12

J

Jump code 109
Jump stitch trim setting key 49
Jump stitch trimming 49, 109

K

Key display optimization 132

L

LCD	12, 24
Lingerie or silk	63
Link function	117
Lock screen key	130
Lock stitching key	71, 72
Locking the needle bar	75
Lower thread guide	11

M

Main power switch	11, 22
Manual color sequence	59
Maximum embroidery speed key	85
Middle thread guide	11
Monitoring App	33

N

Needle	
threading	80
Needle bar case	11
Needle bar key	76, 85
Needle bar/Frame move key	24
Number of thread color changes	71

O

Oiling	142
Operation panel	11, 12, 18
Operator lock	130
Optional accessories	14

P

Pattern display area	24
Pattern editing screen	46
Pattern selection keys	48
Pattern size	46, 70
Positioning keys	48, 71
Power cord receptacle	11
Power supply cord	22, 124
Preview key	47, 71
Previewing the image	61

R

Region display	84
Remaining length	110
Reserve stop key	85, 105
Reserved needle	107
Restart from beginning	91
Resume embroidering	92
Rotate key	47, 71
Rotation angle	46

S

Satin jacket	62
Selecting	
embroidery pattern	37, 44
Setting remaining length	110
Setting up	16
Short stitch delete	110
Shortcut key	38, 43, 48
Silk	63
Size (horizontal)	46
Size (vertical)	46
Size key	47
Speaker	12
Specifications	156
Split (large-size) patterns	121
Spool	77

Spool change indicator	85, 87
Spool stand	11, 20
Stabilizer	62
Start/Stop button	12, 83
Starting/ending position key	71, 112, 113
Stitch count	85
Stitch simulator screen	61
Stopping embroidering	83
at color changes	105
pause	105
Sweater knit	63
Sweatshirt	63

T

Tajima data	109
Temporary needle bar settings key	85, 106
Terms of Use	29
Terry cloth	62
Thread	77
Thread color display	109
Thread color sequence display	84
Thread color set up display	85
Thread density	50
Thread guide	11, 78
Thread guide assembly	19
Thread guide pins	11
Thread mark	53
Thread spools	
easily changing	88
Thread tension disc	78
Thread tension knobs	11, 104
Thread trimming button	12, 84
Threading	
bobbin thread	35
needle	80
upper thread	76
Touch pen holder	11
Trial embroidery key	71
Troubleshooting	144
T-shirt	63

U

Uninterrupted embroidering (one color)	106
Unlock key	85
Updating machine's software	158
USB media	159
Wireless LAN connection	158
Upper thread guide	11
Upper thread guide pretension knob	104
Upper threading	76, 77
USB port	
computer connection	116
USB media connection	116

V

Ventilation slots	11
Version	26

W

Wireless LAN	30
--------------	----









My Stitch Monitor is a mobile app that monitors the operating conditions of your machine.

Visit the Google Play™ or App Store to download.



Google Play™



App Store



Design Database Transfer is a dedicated Windows application for wirelessly transferring embroidery data from a computer to the machine. This application can also be used to view and manage embroidery data.

Visit us at <http://s.brother/cabkb/> to download the application.

Please visit us at <http://s.brother/cpban/> where you can get product support and answers to frequently asked questions (FAQs).



Please visit us at <http://s.brother/cvban/> to view Instruction Videos.



Be sure to install the latest software.
A variety of functional improvements are being performed in the latest version.



Brother SupportCenter is a mobile app that provides the support information for your Brother product.

This machine is approved for use in the country of purchase only. Local Brother companies or their dealers will only support machines purchased in their own countries.

